

The PT5MA potentiometric cable-extension transducer uses a unique thermoplastic cable that has virtually an infinite fatigue life. This cable, known as V62, has properties that are superior for high cycle and rugged applications.

Like Celesco's other transducers, the PT5MA installs in minutes, functions properly without perfectly parallel alignment, and fits easily into small areas. The PT5MA offers additional installation flexibility since its cable exit can be rotated relative to the mounting surface, providing four different cable exit orientations.

Output Signal

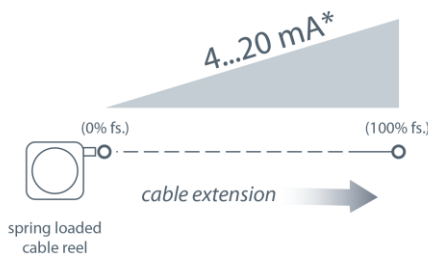

*Optional 3-wire, 0...20mA output signal available.

PT5MA

Cable Actuated Sensor Industrial Grade • 0...5, 0...10 Vdc

Absolute Linear Position to 250 inches (6350 mm)

Hard Anodized Aluminum Enclosure

High Cycle Applications

IP67 • NEMA 6 Protection

General

Full Stroke Range	0-10 to 0-250 inches
Options	
Output Signal Options	4...20 mA (2-wire) and 0...20 mA (3-wire)
Accuracy	± 0.75% to ±0.18% full stroke (see ordering information)
Repeatability	±0.02% to ±0.1% f.s. (see ordering information)
Resolution	essentially infinite
Measuring Cable	stainless steel or thermoplastic
Enclosure	hard anodized aluminum
Sensor	plastic-hybrid precision potentiometer
Potentiometer Cycle Life	see ordering information
Maximum Measuring Cable Velocity	see ordering information
Maximum Retraction Acceleration	see ordering information
Weight	5 lbs. max.

Electrical

Input	see ordering information
Input Current	20 mA max.
Maximum Loop Resistance (Load)	$(\text{loop supply voltage} - 8)/0.020$
Circuit Protection	38 mA max.
Impedance	100 M ohms @ 100 VDC, min.
Signal Adjust, Zero	from factory set zero to 50% of full stroke range
Signal Adjust, Span	to 50% of factory set span

Environmental

Enclosure	NEMA 4/6, IP 65/67
Operating Temperature	-40° to 200°F (-40° to 90°C)
Vibration	up to 10 g to 2000 Hz maximum

EMC COMPLIANCE PER DIRECTIVE 89/336/EEC

Emission/Immunity	EN50081-2 / EN50082-2
--------------------------	-----------------------

PT5MA

Industrial Grade • 0...5, 0...10 Vdc

Outline Drawing

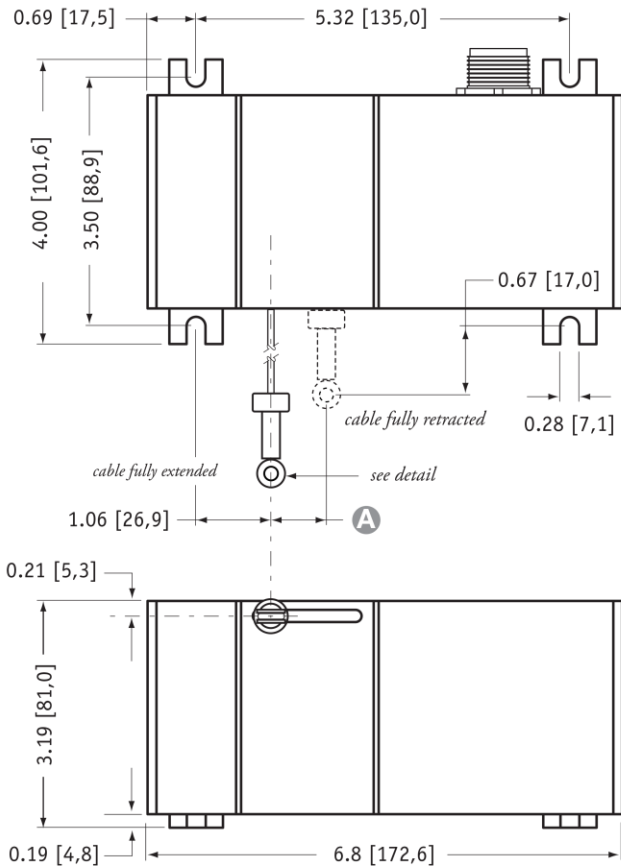

eyelet detail

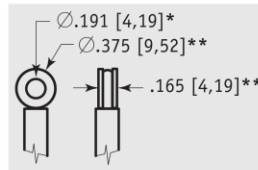

A DIMENSION (inches[mm])

RANGE	S47 & V62	
	N34 measuring cable	measuring cable
10	0.05 [1,2]	0.08 [2,0]
15	0.07 [1,8]	0.12 [3,0]
20	0.09 [2,4]	0.16 [3,9]
30	0.14 [3,5]	0.23 [5,9]
40	0.19 [4,7]	0.31 [7,9]
50	0.23 [5,9]	0.39 [9,9]
60	0.28 [7,0]	0.47 [11,8]
80	0.37 [9,4]	0.62 [15,8]
100	0.46 [11,7]	0.78 [19,7]
125	0.58 [14,7]	0.97 [24,7]
150	0.69 [17,6]	1.16 [29,6]
200	0.92 [23,5]	n/a
250	1.16 [29,3]	n/a

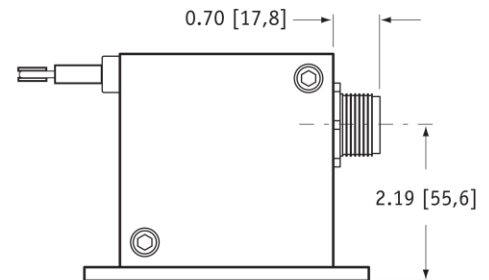

DIMENSIONS ARE IN INCHES [MM]
tolerances are 0.03 IN. [0.5 MM] unless otherwise noted.

* tolerance = +.005 - .001 [+13 - .03]
** tolerance = +.005 - .005 [+13 - 13]

Ordering Information

Model Number:

PT5MA - - - - -
order code: **R** **A** **B** **C** **D**

Sample Model Number:

PT5MA - 100 - N34 - FR - 420E - M6

- R** range: 100 inches
- A** measuring cable: .034 nylon-coated stainless
- B** cable exit: front
- C** output signal: 4...20 mA
- D** electrical connection: 6-pin plastic connector

Full Stroke Range:

R order code:	10	15	20	25	30	40	50	60	80	100	125	150	200	250
full stroke range, min:	10 in.	15 in.	20 in.	25 in.	30 in.	40 in.	50 in.	60 in.	80 in.	100 in.	125 in.	150 in.	200 in.	250 in.
accuracy (±% of f.s.):	.75%	.6%	.5%	.5%	.5%	.3%	.3%	.25%	.25%	.25%	.25%	.18%	.18%	.18%
repeatability (±% of f.s.):	.1%	.1%	.05%	.05%	.05%	.05%	.05%	.02%	.02%	.02%	.02%	.02%	.02%	.02%
potentiometer cycle life:	2,500,000 cycles							500,000 cycles			250,000 cycles			
cable tension (20%):	41 ounces											21 ounces		
max. cable velocity/acceleration:	300 in./sec • 5 g											120 in./sec • 2 g		

PT5MA

Industrial Grade • 0...5, 0...10 Vdc

Measuring Cable:

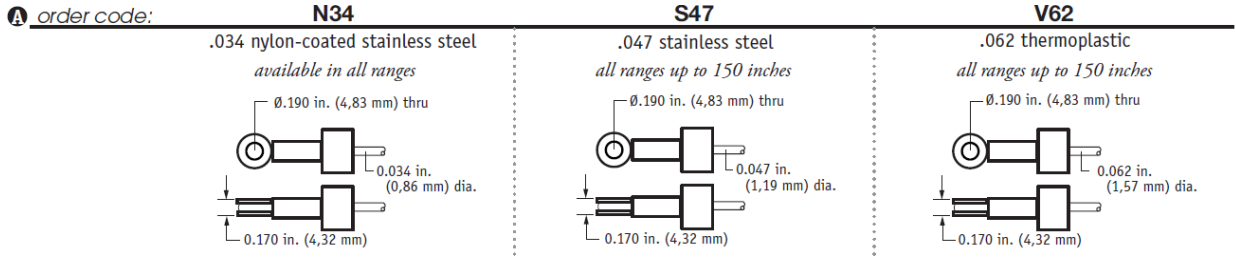

Cable Exit:

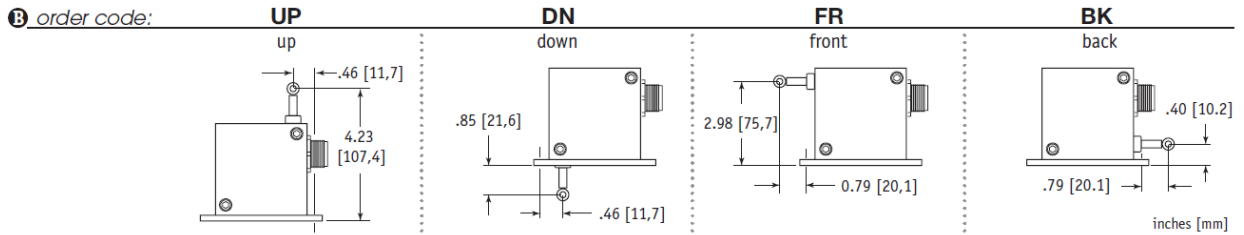

Output Signals:

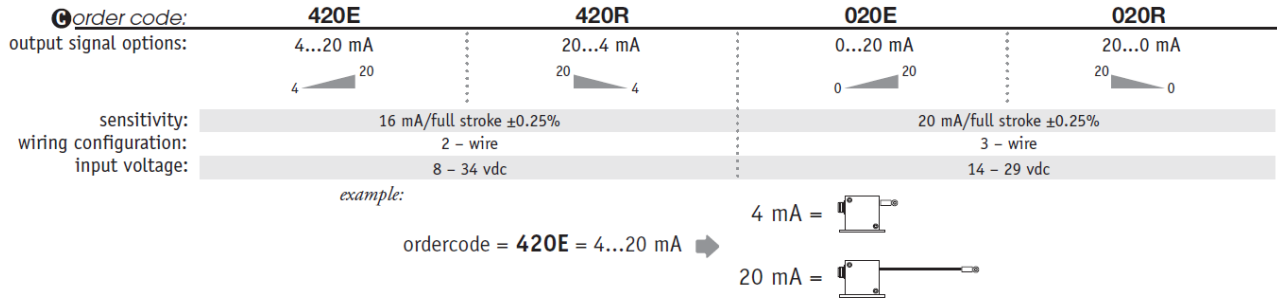

Electrical Connection:

