

Features

- 1.6 to 5.5V operating supply voltage range
- Oscillation frequency range (varies with version)
 - ◆ 1.6 to 5.5V: 40MHz to 165MHz
- -40 to 85 operating temperature range
- Voltage regulator build-in
- Oscillation capacitors build-in
- Inverter amplifier feedback resistor built-in
- Oscillation detector function built-in
- Standby function
 - ◆ High impedance in standby mode, oscillator stops
- Low standby current
 - ◆ Power-save pull-up resistor built-in
- CMOS output duty level
- 15pf output load
- 8mA output drive capability($V_{DD}=1.6V$)
- Die form(PT7C5035ALx)

Application

- Used for crystal oscillator

Description

The PT7C5035 series are 1.8V operation, high-frequency crystal oscillator module ICs. They support 40MHz to 165MHz (1.6-5.5V) 3rd overtone oscillation and fundamental oscillation modes. The crystal oscillator circuit has voltage regulator drive, significantly reducing current consumption and crystal current, significantly reducing the oscillator characteristics supply voltage dependency. The output circuit comprises a CMOS buffer than can operate at high frequencies and drive a 15pf capacitance load.

Ordering Information

Part no.	Package type
PT7C5035ALx-2GDE	Die form
PT7C5035ALx-2DE	Die form
PT7C5035ALx-5GDE	Die form
PT7C5035ALx-2GWF	Wafer form
PT7C5035ALx-2WF	Wafer form
PT7C5035ALx-5GWF	Wafer form

Note: 1. "x" shows the different function. See below table.
 2. "-2G" show the die thickness is $220\pm 20\mu m$ without coating; "-2" show the die thickness is $220\pm 20\mu m$ with coating; "-5G" show the die thickness is $130\pm 10\mu m$ without coating;

Series Configuration

Part No	Operation supply Voltage(V)	Recommended operating frequency range(MHz)	Built-in capacitance(pF)	
			C _{IN}	C _{OUT}
PT7C5035ALF	1.6 to 5.5	40 to 70	6	6
PT7C5035ALA		60 to 90	4	4
PT7C5035ALB		90 to 110	4	4
PT7C5035ALC		110 to 135	2	3
PT7C5035ALD		135 to 165	2	3

Note: * 1. The recommended operating frequency is a yardstick value derived from the crystal used for PTI characteristics authentication. However, the oscillator frequency band is not guaranteed. Specifically, the characteristics can vary greatly due to crystal characteristics and mounting conditions, so the oscillation characteristics of components must be carefully evaluated.

Block Diagram

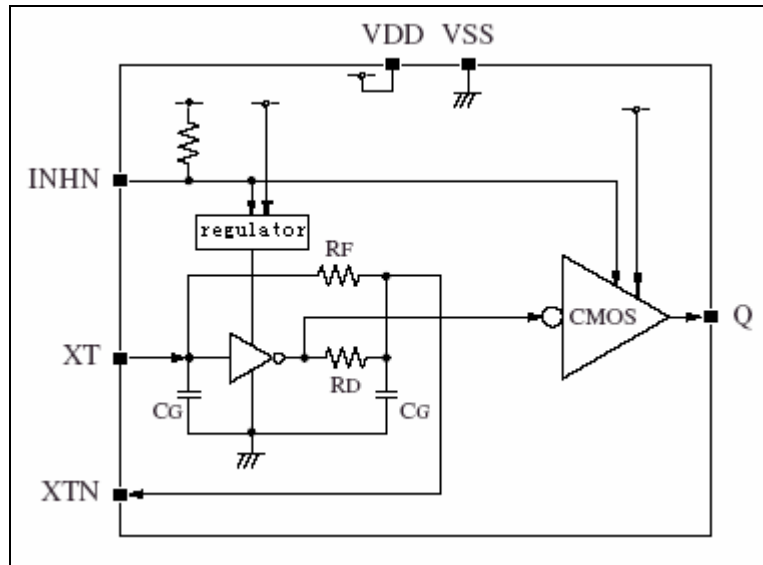

Function Description

Standby Function

When INHN goes LOW, the device is in standby mode. The Q output becomes high impedance and the oscillator circuit stops.

OE	Q	Oscillator
HIGH(or open)	f0 output frequency	Normal operation
LOW	High impedance	Stopped

Build-in voltage regulator

The voltage regulator generate a stable voltage supplying the oscillator, significantly reducing current consumption and crystal current, significantly reducing the oscillator characteristics supply voltage dependency.

Power-saving Pull-up Resistor

The INHN pin pull-up resistance changes in response to the input level(HIGH or LOW).When OE is tied LOW ,the pull-up resistance becomes large, reducing the current consumed by the resistance. When INHN is left open, pull-up resistance becomes small, such that even if the input is affected by external noise the outputs are stable due to INHN being tied HIGH by the pull-up resistor.

Oscillation Detector Function

The devices also feature an oscillation detector circuit. This circuit function to disable the outputs until the oscillator circuit starts. This prevents abnormal oscillator output at oscillator start-up when power is applied or when INHN is switched.

Pad Configuration

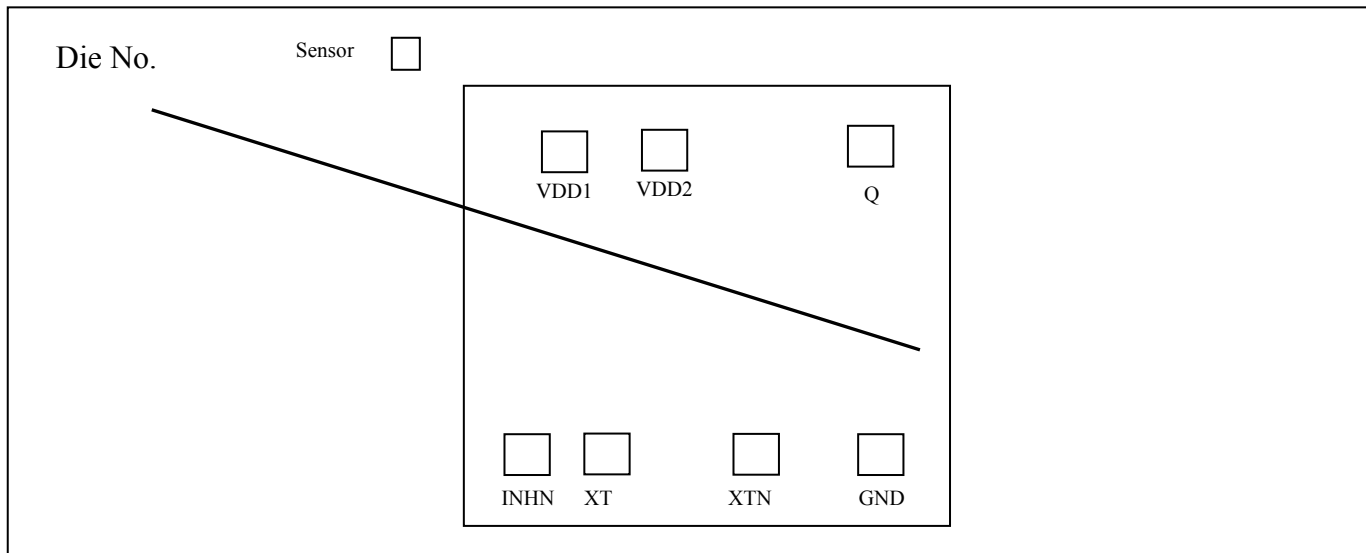

Pad Coordinate File					
Pad Name	X Coordinate	Y Coordinate	Pad Name	X Coordinate	Y Coordinate
sensor	-50	930.00	GND	730.60	92.60
INHN	171.20	92.60	Q	730.60	801.60
XT	301.20	92.60	VDD2	342.00	801.60
XTN	516.40	92.60	VDD1	212.00	801.60

Note1: Substrate is connected to GND for 130μm and 220μm without coating; To 220μm with coating, substrate is connected to GND or VDD or floating.

Note2: VDD1 and VDD2 are both supply voltage and connecting with metal on the chip. Bonding any one is OK.

Die Size: 910μm*980μm (Including scribe line size100μm*100μm.)

Die Thickness: PT7C5035ALx-2G/PT7C5035ALx-2: 220μm±20μm; PT7C5035ALx-5G: 130μm±10μm.

Pad Size: 90μm*90μm

Pad Description

Sym.	Type	Description	
INHN	I	Output state control input. Oscillator stops when Low. Power-saving pull-up resistor built-in	
XT	I	Oscillator input pin.	Crystal connection pins. Crystal is connected between XT and XTN
XTN	O	Oscillator output pin.	
GND	P	Ground (-).	
Q	O	Output. Output frequency. High impedance in standby mode.	
VDD (VDD1 or VDD2)	P	Supply voltage.	

Maximum Ratings

Storage Temperature	-65°C to +150°C
Supply Voltage range	-0.5V to +5.0V
Input voltage range	GND-0.5V to V _{DD} +0.5V
Output voltage range	GND-0.5V to V _{DD} +0.5V
Output current	25mA

Note:
 Stresses greater than those listed under MAXIMUM RATINGS may cause permanent damage to the device. This is a stress rating only and functional operation of the device at these or any other conditions above those indicated in the operational sections of this specification is not implied. Exposure to absolute maximum rating conditions for extended periods may affect reliability.

Recommended Operating Conditions

C_L ≤ 15pF

Sym.	Parameter	Conditions	Min	Typ	Max	Unit	
V _{DD}	Supply voltage	40MHz ≤ f ≤ 70MHz	5035ALF	1.6	-	5.5	V
		60MHz ≤ f ≤ 90MHz	5035ALA	1.6	-	5.5	
		90MHz ≤ f ≤ 110MHz	5035ALB	1.6	-	5.5	
		110MHz ≤ f ≤ 135MHz	5035ALC	1.6	-	5.5	
		135MHz ≤ f ≤ 165MHz	5035ALD	1.6	-	5.5	
V _{IN}	Input voltage	Input pins	GND	-	V _{DD}	V	
T _A	Operating temperature	-	-40	+25	+85	°C	

DC Electrical Characteristics

Symbol	Parameter	Condition		Min	Typ	Max	Unit				
I _{DD}	Operating current Consumption*1	Measurement cct1, INHN=open or HIGH, CL=15pF	5035ALF f=70MHz	V _{DD} =1.8V	-	6.5	10	mA			
				V _{DD} =2.5V	-	8.5	16				
				V _{DD} =3.3V	-	11	20				
				V _{DD} =5.0V	-	16	26				
			5035ALA f=90MHz	V _{DD} =1.8V	-	9	16				
				V _{DD} =2.5V	-	12	20				
				V _{DD} =3.3V	-	14	24				
				V _{DD} =5.0V	-	18	30				
			5035ALB f=110MHz	V _{DD} =1.8V	-	12	20				
				V _{DD} =2.5V	-	14	24				
				V _{DD} =3.3V	-	18	30				
			5035ALC f=135MHz	V _{DD} =5.0V	-	24	40				
				V _{DD} =1.8V	-	14	24				
				V _{DD} =2.5V	-	18	30				
				V _{DD} =3.3V	-	24	40				
			5035ALD f=165MHz	V _{DD} =5.0V	-	28	50				
				V _{DD} =1.8V	-	18	30				
				V _{DD} =2.5V	-	24	40				
			I _{ST}	Standby current	Measurement cct1, INHN=LOW	V _{DD} =3.3V	-		24	40	μA
						V _{DD} =5.0V	-		32	60	
V _{OH}	HIGH-level Output voltage	Q: Measurement cct3, V _{DD} =1.6 to 5.5V, I _{OH} =8mA	V _{DD} -0.4	V _{DD} -0.3	-	V					
V _{OL}	LOW-level	Q: Measurement cct3, V _{DD} =1.6 to 5.5V, I _{OL} =8mA	-	0.3	0.4	V					
I _Z	Output leakage current	Q: Measurement cct5, INHN=LOW, V _{DD} =5.5V	V _{OH} =V _{DD}	-	-	10	μA				
			V _{OL} =GND	-	-	10	μA				
V _{IH}	HIGH-level	INHN, Measurement cct4	0.7V _{DD}	-	-	V					
V _{IL}	LOW-level	INHN, Measurement cct4	-	-	0.3V _{DD}	V					
R _{UP1}	INHN pull-up resistance	Measurement cct6	INHN=GND	0.4	-	4	M				
R _{UP2}			INHN=0.7V _{DD}	30	-	150	K				

Note: *1: The operating current consumption includes the C_L=15pF capacitance load charging current.

AC Electrical Characteristics

Symbol	Parameter	Conditions	min	typ	max	Unit	
Duty	Output duty cycle	Measurement cct1, $T_A=25^\circ\text{C}$, $C_L=15\text{pF}$	$V_{DD}=2.25$ to 5.5V	45	50	55	%
			$V_{DD}=1.6$ to 2.25V	40	50	60	
Tr1	Rise time	Measurement cct1, $C_L=15\text{pF}$, $V_{DD}=2.25$ to 5.5V , $0.1V_{DD}$ to $0.9V_{DD}$	-	1	2	ns	
Tr2	Rise time	Measurement cct1, $C_L=15\text{pF}$, $V_{DD}=1.6$ to 2.25V , $0.2V_{DD}$ to $0.8V_{DD}$	-	1.5	2.5		
Tf1	Fall time	Measurement cct1, $C_L=15\text{pF}$, $V_{DD}=2.25$ to 5.5V , $0.9V_{DD}$ to $0.1V_{DD}$	-	1	2		
Tf2	Fall time	Measurement cct1, $C_L=15\text{pF}$, $V_{DD}=1.6$ to 2.25V , $0.8V_{DD}$ to $0.2V_{DD}$	-	1.5	2.5		
T_{OE}	Output enable delay time	Measurement cct2, $C_L \leq 15\text{pF}$, $T_A=25^\circ\text{C}$, INHN=LOW to HIGH	-	-	2	ms	
T_{OD}	Output disable delay time	Measurement cct2, $C_L \leq 15\text{pF}$, $T_A=25^\circ\text{C}$, INHN=HIGH to LOW	-	-	200	ns	

1. Oscillator stop function is built-in. When INHN goes LOW, normal output stops. When INHN goes HIGH, normal output is not resumed until after the oscillator start-up time has elapsed.

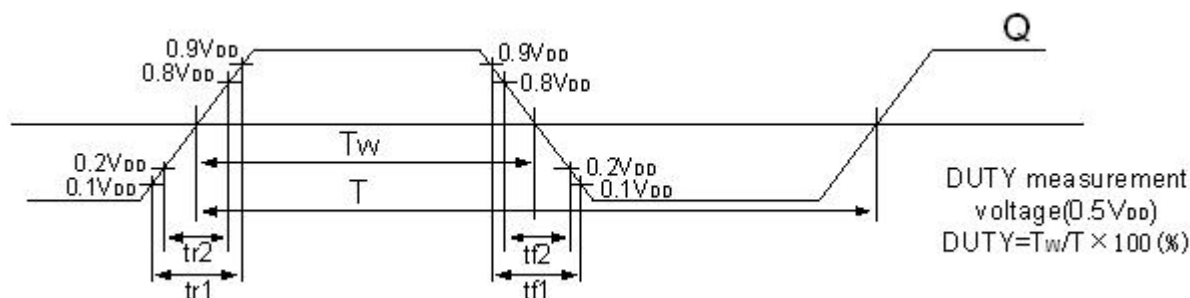

Figure1. Output switching waveform

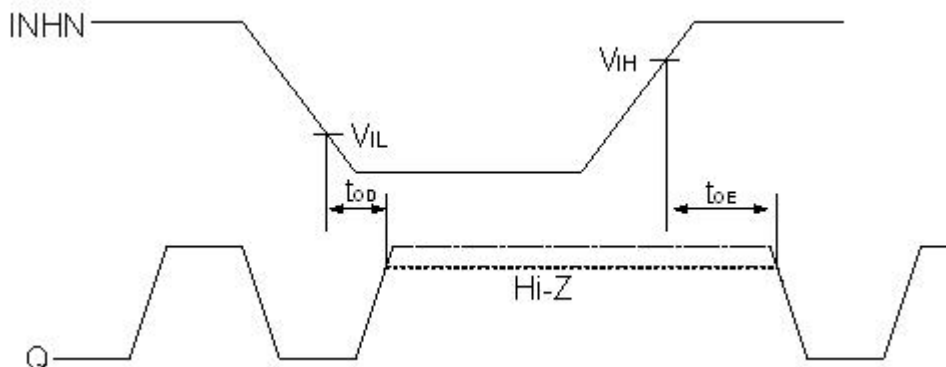
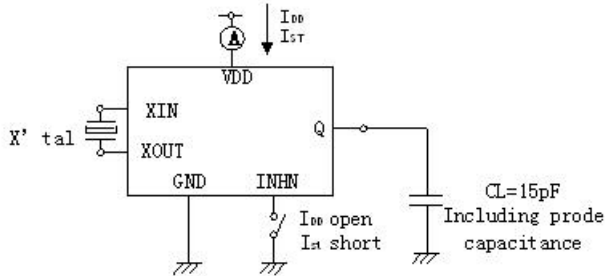

Figure2. Output disable/enable timing chart

Measurement Circuit

Measurement cct1

Measurement parameter: I_{DD} , I_{ST} , Duty, t_r , t_f



Note: The AC characteristics are observed using an oscilloscope on pin Q

Measurement cct2

Measurement parameter: t_{OR} , t_{OF}

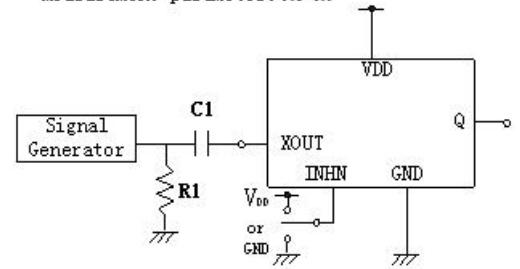

XOUT input signal: 1Vp-p, sine wave
 C1: 0.001uF R1: 50Ω

Measurement cct3

Measurement parameter: V_{OH} , V_{OL}

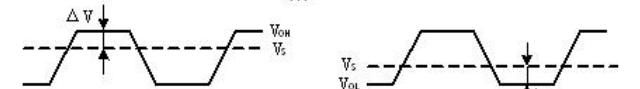
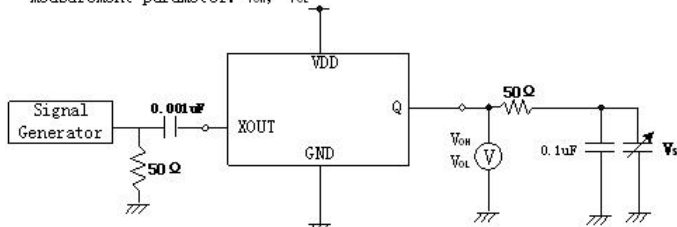

V_S adjusted such that $\Delta V = 50 \times I_{OH}$

V_S adjusted such that $\Delta V = 50 \times I_{OL}$

XOUT input signal: 1Vp-p, sine wave

Measurement cct4

Measurement parameter: V_{IH} , V_{IL}

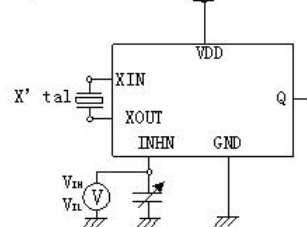

V_{IH} : Voltage is 0V to V_{DD} transition that changes the output state.
 V_{IL} : Voltage is V_{DD} to 0V transition that changes the output state.
 INHN has an oscillation stop function

Measurement cct5

Measurement parameter: I_I

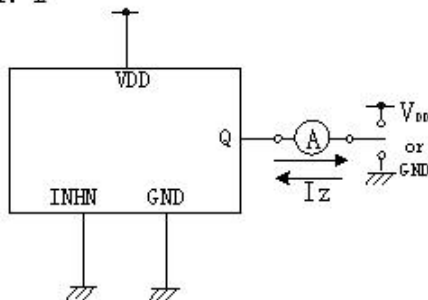

Measurement cct6

Measurement parameter: R_{UP1} , R_{UP2}

