



## Features

- Carbon element
- Metal housing
- 15-60 mm travel
- Single and dual gang
- Center detent option
- RoHS compliant\*



## PTA Series - Low Profile Slide Potentiometer

### Electrical Characteristics

Taper..... Linear, audio  
 Standard Resistance Range  
 ..... 1 K ohms to 1 M ohms  
 Standard Resistance Tolerance..... ±20 %  
 Residual Resistance  
 ..... 500 ohms or 1 % max.  
 Insulation Resistance  
 ..... Min. 100 megohms at 250 V DC

### Environmental Characteristics

Operating Temperature  
 ..... -10 °C to +50 °C  
 Power Rating, Linear  
 15 mm .... 0.05 W (0.025 W Dual Gang)  
 20 mm ..... 0.1 W (0.05 W)  
 30 mm ..... 0.2 W (0.1 W)  
 45 mm ..... 0.25 W (0.125 W)  
 60 mm ..... 0.25 W (0.125 W)  
 Power Rating, Audio  
 15 mm .. 0.025 W (0.015 W Dual Gang)  
 20 mm ..... 0.05 W (0.025 W)  
 30 mm ..... 0.1 W (0.05 W)  
 45 mm ..... 0.125 W (0.06 W)  
 60 mm ..... 0.125 W (0.06 W)  
 Maximum Operating Voltage, Linear  
 15 mm ..... 100 V DC  
 20-60 mm ..... 200 V DC  
 Maximum Operating Voltage, Audio  
 15 mm ..... 50 V DC  
 20-60 mm ..... 150 V DC  
 Withstand Voltage, Audio  
 ..... 1 Min. at 300 V AC  
 Sliding Noise ..... 100 mV maximum  
 Tracking Error ..... 3 dB at -40 to 0 dB

### Mechanical Characteristics

Operating Force ..... 30 to 250 gf  
 Stop Strength ..... 5 kgf min.  
 Sliding Life ..... 15,000 cycles  
 Soldering Condition  
 .. 350 °C max. within 3 ± 0.5 seconds  
 Travel ..... 15, 20, 30, 45, 60 mm

### Lever Style & Product Dimensions

Actuator Styles  
 DP METAL LEVER

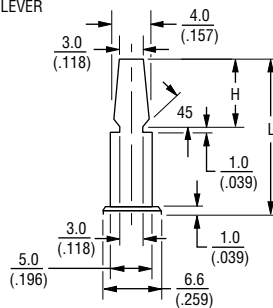

CI INSULATED LEVER

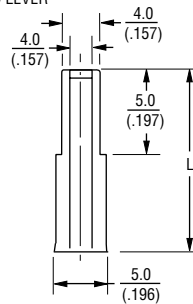

CP METAL LEVER

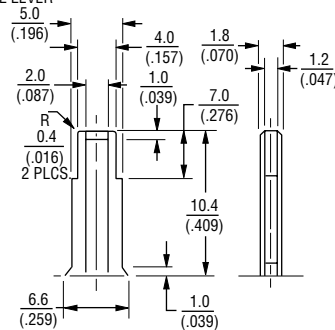

Dimension	
L	H
15 (.591)	10 (.394)
10 (.394)	7 (.276)

DIMENSIONS:  $\frac{\text{MM}}{\text{(INCHES)}}$

### Additional Information

Click these links for more information:



### How To Order

**PTA 15 4 3 - 2 0 10 DP B 203**

Model \_\_\_\_\_  
 Stroke Length \_\_\_\_\_  
 • 15 = 15 mm  
 • 20 = 20 mm  
 • 30 = 30 mm  
 • 45 = 45 mm  
 • 60 = 60 mm  
 Dust Cover Option \_\_\_\_\_  
 • 4 = No Dust Cover  
 No. of Gangs \_\_\_\_\_  
 • 3 = Single Gang  
 • 4 = Dual Gang  
 Pin Style \_\_\_\_\_  
 • 2 = PC Pins Down Facing  
 Center Detent Option \_\_\_\_\_  
 • 0 = No Detent  
 • 2 = Center Detent  
 Standard Lever Length \_\_\_\_\_  
 (See Table)  
 • 10 = 10 mm  
 • 15 = 15 mm  
 Lever Style \_\_\_\_\_  
 • DP = Metal Lever (Refer to Drawing)  
 • CP = Metal Lever (Refer to Drawing)  
 • CI = Insulated Lever  
 (Refer to Drawing)  
 Resistance Taper \_\_\_\_\_  
 • A = Audio Taper  
 • B = Linear Taper  
 Resistance Code (See Table) \_\_\_\_\_

Other styles available.



**WARNING Cancer and Reproductive Harm - [www.P65Warnings.ca.gov](http://www.P65Warnings.ca.gov)**

\*RoHS Directive 2015/863, Mar 31, 2015 and Annex.

Specifications are subject to change without notice.

Users should verify actual device performance in their specific applications.

The products described herein and this document are subject to specific legal disclaimers as set forth on the last page of this document, and at [www.bourns.com/docs/legal/disclaimer.pdf](http://www.bourns.com/docs/legal/disclaimer.pdf).

## Applications

- Audio/TV sets
- Amplifiers/mixers/drum machines/synthesizers
- PCs/monitors
- Appliances

# PTA Series - Low Profile Slide Potentiometer

# BOURNS®

## Product Dimensions

PTAxx43

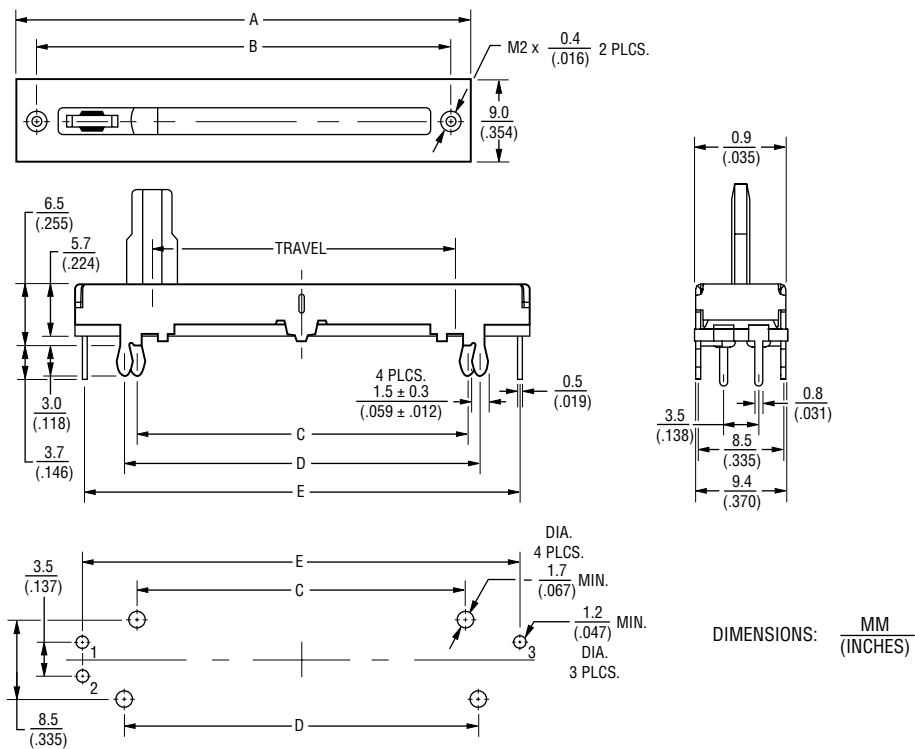

## Single Gang Dimensions

Model	A	B	C	D	E	Travel
PTA1543	$\frac{30}{(1.18)}$	$\frac{26}{(1.02)}$	$\frac{17.8}{(0.700)}$	$\frac{20.2}{(0.795)}$	$\frac{28.5}{(1.12)}$	$\frac{15}{(0.59)}$
PTA2043	$\frac{35}{(1.37)}$	$\frac{31}{(1.22)}$	$\frac{22.8}{(0.897)}$	$\frac{25.2}{(0.992)}$	$\frac{33.5}{(1.32)}$	$\frac{20}{(0.787)}$
PTA3043	$\frac{45}{(1.77)}$	$\frac{41}{(1.61)}$	$\frac{32.8}{(1.29)}$	$\frac{35.2}{(1.38)}$	$\frac{43.5}{(1.71)}$	$\frac{30}{(1.18)}$
PTA4543	$\frac{60}{(2.36)}$	$\frac{56}{(2.20)}$	$\frac{47.8}{(1.88)}$	$\frac{50.2}{(1.97)}$	$\frac{58.5}{(2.30)}$	$\frac{45}{(1.77)}$
PTA6043	$\frac{75}{(2.95)}$	$\frac{71}{(2.79)}$	$\frac{62.8}{(2.47)}$	$\frac{65.2}{(2.56)}$	$\frac{73.5}{(2.89)}$	$\frac{60}{(2.36)}$

## Schematic

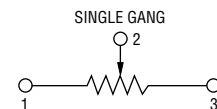

Specifications are subject to change without notice.

Users should verify actual device performance in their specific applications.

The products described herein and this document are subject to specific legal disclaimers as set forth on the last page of this document, and at [www.bourns.com/docs/legal/disclaimer.pdf](http://www.bourns.com/docs/legal/disclaimer.pdf).

# PTA Series - Low Profile Slide Potentiometer

**BOURNS®**

## Product Dimensions

PTAxx44



## Dual Gang Dimensions

Model	A	B	C	D	E	F	Travel
PTA1544	$\frac{30}{(1.18)}$	$\frac{26}{(1.02)}$	$\frac{17.8}{(.700)}$	$\frac{20.2}{(.795)}$	$\frac{28.5}{(1.12)}$	$\frac{18}{(.708)}$	$\frac{15}{(.59)}$
PTA2044	$\frac{35}{(1.37)}$	$\frac{31}{(1.22)}$	$\frac{22.8}{(.897)}$	$\frac{25.2}{(.992)}$	$\frac{33}{(1.29)}$	$\frac{23}{(.905)}$	$\frac{20}{(.787)}$
PTA3044	$\frac{45}{(1.77)}$	$\frac{41}{(1.61)}$	$\frac{32.8}{(1.29)}$	$\frac{35.2}{(1.38)}$	$\frac{43.5}{(1.71)}$	$\frac{33}{(1.29)}$	$\frac{30}{(1.18)}$
PTA4544	$\frac{60}{(2.36)}$	$\frac{56}{(2.20)}$	$\frac{47.8}{(1.88)}$	$\frac{50.2}{(1.97)}$	$\frac{58.5}{(2.30)}$	$\frac{48}{(1.88)}$	$\frac{45}{(1.77)}$
PTA6044	$\frac{75}{(2.95)}$	$\frac{71}{(2.79)}$	$\frac{62.8}{(2.47)}$	$\frac{65.2}{(2.56)}$	$\frac{73.5}{(2.89)}$	$\frac{63}{(2.48)}$	$\frac{60}{(2.36)}$

## Schematic

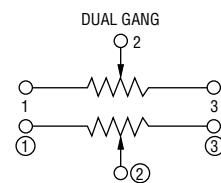

Specifications are subject to change without notice.

Users should verify actual device performance in their specific applications.

The products described herein and this document are subject to specific legal disclaimers as set forth on the last page of this document, and at [www.bourns.com/docs/legal/disclaimer.pdf](http://www.bourns.com/docs/legal/disclaimer.pdf).

# PTA Series - Low Profile Slide Potentiometer

**BOURNS®**

## Derating Curve

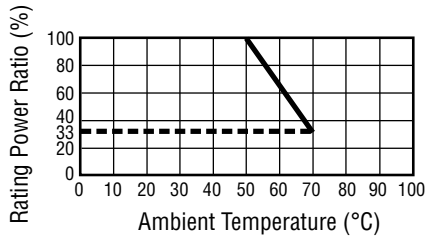

## Standard Resistance Table

Resistance (Ohms)	Resistance Code
1,000	102
2,000	202
5,000	502
10,000	103
20,000	203
50,000	503
100,000	104
200,000	204
500,000	504
1,000,000	105

## Tapers

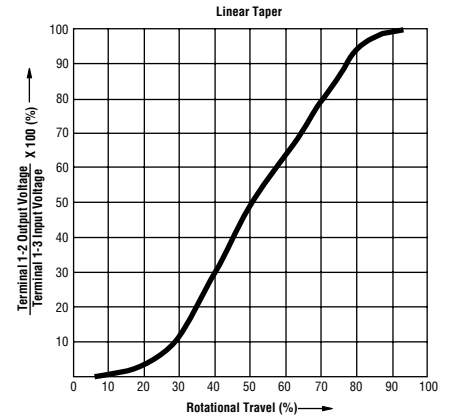
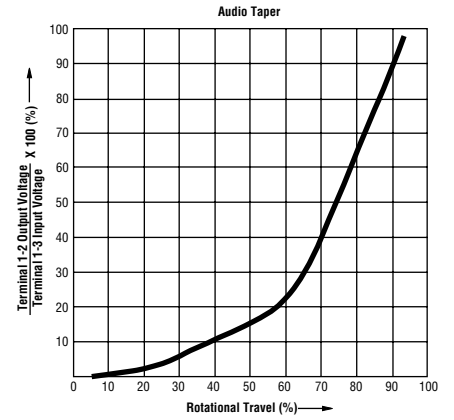

REV. 04/21

Specifications are subject to change without notice.

Users should verify actual device performance in their specific applications.

The products described herein and this document are subject to specific legal disclaimers as set forth on the last page of this document, and at [www.bourns.com/docs/legal/disclaimer.pdf](http://www.bourns.com/docs/legal/disclaimer.pdf).