

# PTE7100 SERIES

## HERMETIC ANALOG PRESSURE SENSOR

The PTE7100 pressure sensor is the ideal solution for customers with challenging measuring requirements for general industrial applications in the mid and high pressure ranges. Utilizing Sensata's automotive leading Micro Silicon Strain Gauge with best-in-class accuracy, the PTE7100 features a wide range of ports, connectors, and analog electrical outputs for ease of integration in various industrial applications.

The PTE7100's high quality stainless steel design features a hermetic port with no internal o-ring seals making it compatible with most media and suitable for harsh environments. With extreme shock and vibration capabilities, a wide operating temperature range, and high proof and burst pressures; the PTE7100 is ideal for industrial applications including injection molding, CO<sub>2</sub> HVAC systems, and other hydraulic or pneumatic applications.



### Features

- Measuring range from 0-50 bar to 0-600 bar (0-725 to 0-8700 psi)
- High accuracy
- Wide range of ports, connectors, and electrical outputs
- Stainless steel design with hermetic port
- Storage and operating media temperature -40-125°C; Operating ambient temp. range -40-100°C
- Snubber option for dampening of pressure spikes due to hammer and cavitation
- REACH/RoHS/CE compliant

### Applications

- Hydraulics and Pneumatics
- Mobile Hydraulics and Off-Highway Vehicles
- Pumps and Compressors
- Air Conditioning and Refrigeration Systems
- Plant Engineering and Automation

## SPECIFICATIONS

### Electrical

<b>Pressure Ranges</b>	0-50 to 0-600 bar (0-725 to 0-8700 psi)
<b>Pressure Reference</b>	Gauge
<b>Supply Voltage/Output</b>	8-32VDC for 4-20mA output 5±0.25VDC for 0.5-4.5VDC output 8-32VDC for 0-5VDC output 12-32VDC for 0-10VDC output 8-32VDC for 1-5VDC output 8-32VDC for 0.5-4.5VDC output
<b>Output Load</b>	≥ 4.7 kΩ for voltage output ≤ (Vsup-8)/20mA for current supply
<b>Output Response Time</b>	<2 ms
<b>Overvoltage Protection</b>	36 VDC
<b>Reverse Voltage Protection</b>	Yes
<b>Short Circuit Protection</b>	Yes
<b>Insulation Resistance</b>	> 100 MΩ at 500V
<b>EMC</b>	IEC 61326-1 and EN 61326-2-3
<b>Dielectric Strength</b>	500 VAC
<b>Enhanced Radiated Immunity</b>	100V/m (80-200MHz) 200V/m (200-2700MHz)
<b>Enhanced ESD</b>	±8KV Contact; ±15KV Air

## Physical

<b>Proof Pressure</b>	2X full scale pressure <sup>(1)</sup>
<b>Burst Pressure</b>	20X for full scale pressure = 50-100 bar 10X for full scale pressure = 101-400 bar 4000 bar for full scale pressure = 401-600 bar
<b>Random Vibration</b>	IEC 60068-2-6, 30g (10...2000Hz)
<b>Mechanical Shock</b>	EN 60068-2-27, 500g
<b>Drop (any Axis)</b>	1m
<b>Ingress Protection</b>	IP65 - IP67 (see Connector Options)
<b>Media Compatibility</b>	Fluids and Gases compatible with 17-4PH stainless steel

## Performance

<b>Accuracy (Best Fit Straight Line)<sup>(2)</sup></b>	±0.25%FS @25°C
<b>Accuracy (Total Error Band)<sup>(3)</sup></b>	+/-1.5%FS @-20° to 85°C
<b>Operating Endurance</b>	>10M cycles
<b>Operating Ambient Temperature</b>	-40° to +100°C
<b>Operating Media Temperature</b>	-40° to +125°C
<b>Storage Temperature</b>	-40° to +125°C <sup>(4)</sup>



## DIMENSIONS

All dimensions are in millimeters

### Pressure Port

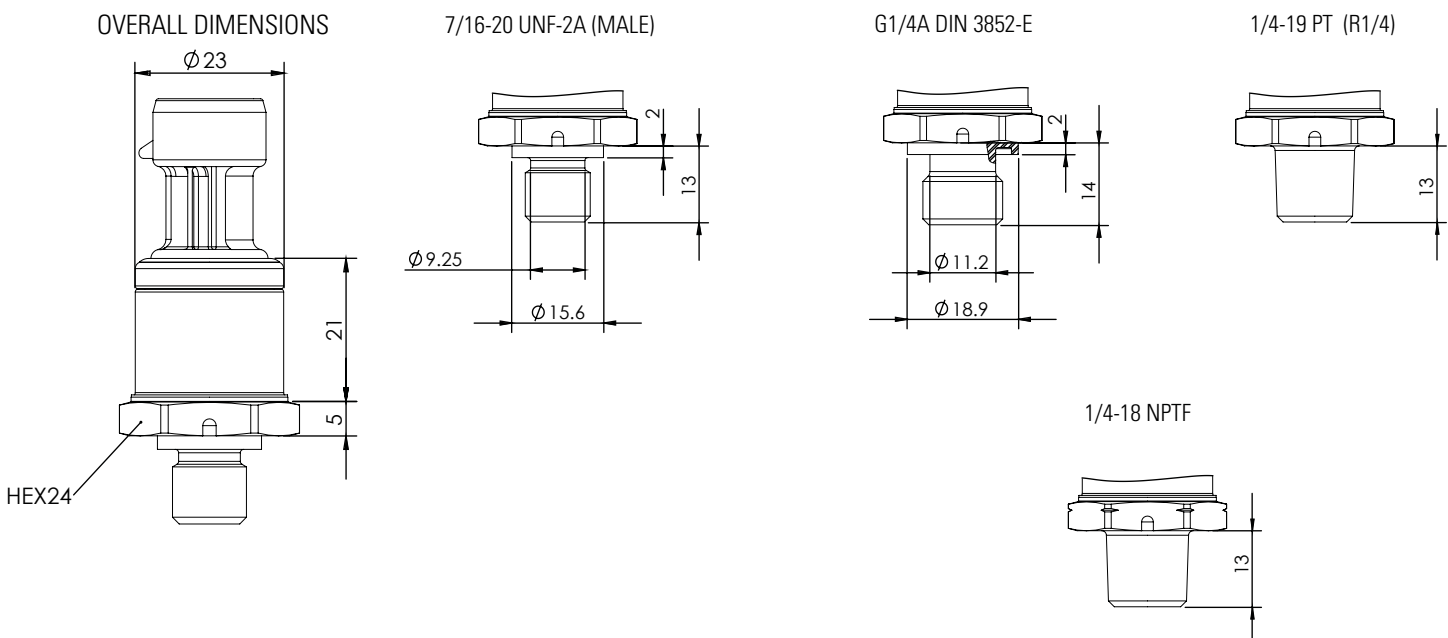

# Electrical Connector

PACKARD METRI-PACK 150  
IP67



Output Type	PIN A	PIN B	PIN C
<b>Voltage</b>	V-	V+	Vout
<b>Current</b>	lout	V+	...

M12x1 4-POLE  
IP67

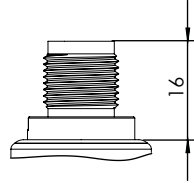

Output Type	PIN 1	PIN 2	PIN 3	PIN 4
<b>Voltage</b>	V+	...	V-	Vout
<b>Current</b>	V+	...	lout	...

A: DIN 175301-803 FORM A(18mm)  
IP65

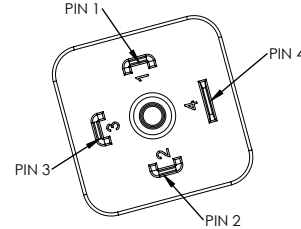
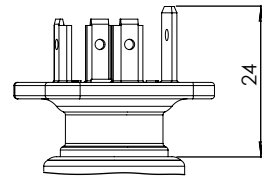

Output Type	PIN 1	PIN 2	PIN 3	PIN 4
<b>Voltage</b>	V+	V-	Vout	...
<b>Current</b>	V+	lout	...	...

DEUTSCH DT04-3P  
IP67

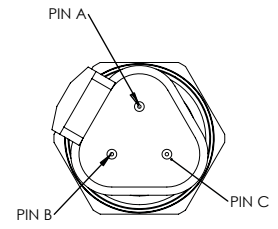
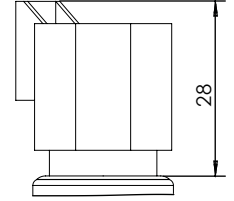

Output Type	PIN A	PIN B	PIN C
<b>Voltage</b>	V+	V-	Vout
<b>Current</b>	V+	lout	...

FLY LEAD WITH HARNESS  
IP67



Output Type	RED	BLACK	WHITE
<b>Voltage</b>	V+	V-	Vout
<b>Current</b>	V+	lout	...



# ORDERING OPTIONS

Example : PTE7100-31AA-1A250BS

PTE7100 with G1/4A thread with external FKM o-ring seal, DIN A connector, 4-20

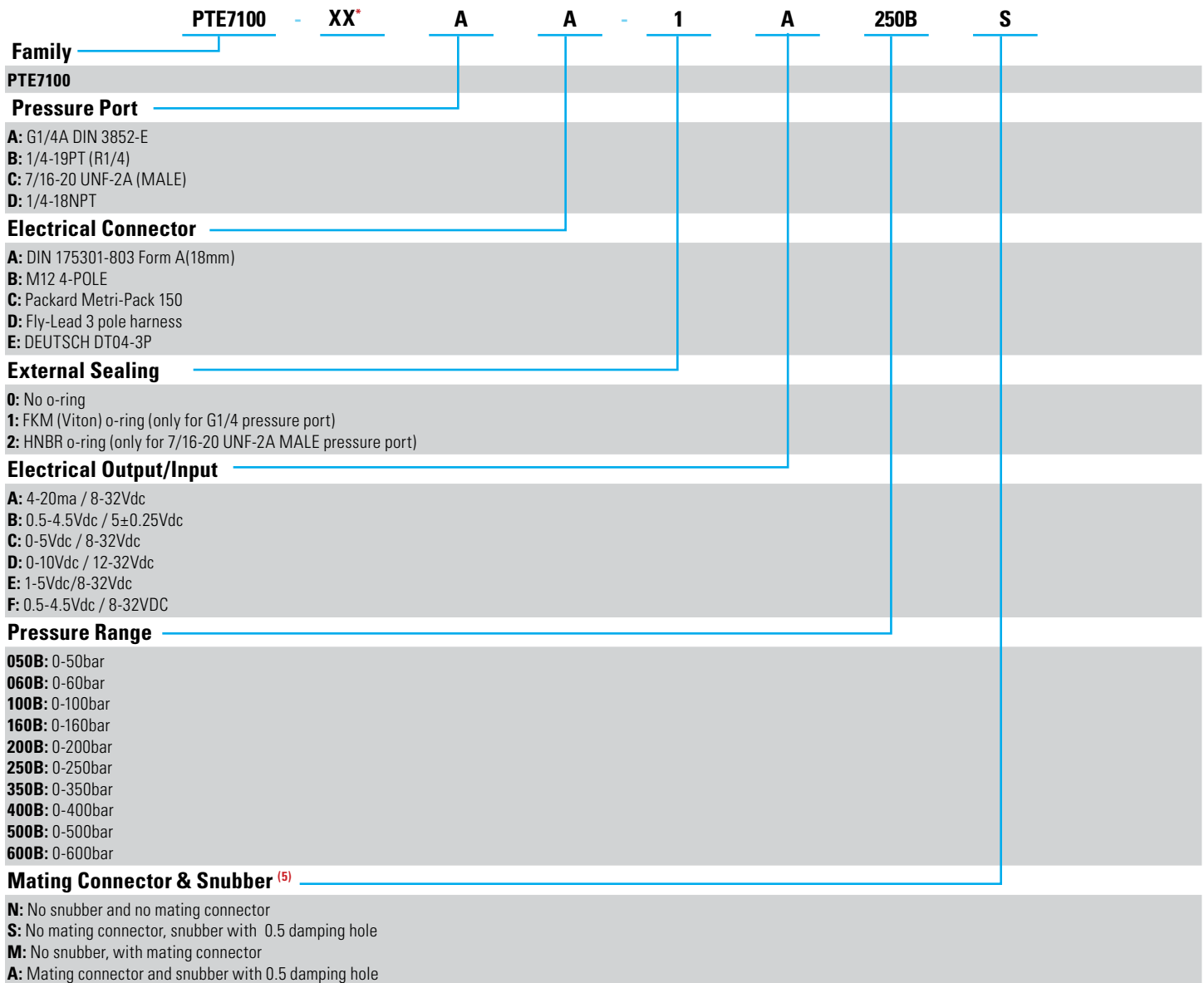

\*Factory Specified



# AGENCY APPROVALS & CERTIFICATIONS

