

PTE7100 SERIES

HERMETIC ANALOG PRESSURE SENSOR

The PTE7100 pressure sensor is the ideal solution for customers with challenging measuring requirements for general industrial applications in the mid and high pressure ranges. Utilizing Sensata's automotive leading Micro Silicon Strain Gauge with best-in-class accuracy, the PTE7100 features a wide range of ports, connectors, and analog electrical outputs for ease of integration in various industrial applications.

The PTE7100's high quality stainless steel design features a hermetic port with no internal o-ring seals making it compatible with most media and suitable for harsh environments. With extreme shock and vibration capabilities, a wide operating temperature range, and high proof and burst pressures; the PTE7100 is ideal for industrial applications including injection molding, CO₂ HVAC systems, and other hydraulic or pneumatic applications.



Features

- Measuring range from 0-50 bar to 0-600 bar (0-725 to 0-8700 psi)
- High accuracy
- Wide range of ports, connectors, and electrical outputs
- Stainless steel design with hermetic port
- Storage and operating media temperature -40-125°C; Operating ambient temp. range -40-100°C
- Snubber option for dampening of pressure spikes due to hammer and cavitation
- REACH/RoHS/CE compliant

Applications

- Hydraulics and Pneumatics
- Mobile Hydraulics and Off-Highway Vehicles
- Pumps and Compressors
- Air Conditioning and Refrigeration Systems
- Plant Engineering and Automation

SPECIFICATIONS

Electrical

Pressure Ranges	0-50 to 0-600 bar (0-725 to 0-8700 psi)
Pressure Reference	Gauge
Supply Voltage/Output	8-32VDC for 4-20mA output 5±0.25VDC for 0.5-4.5VDC output 8-32VDC for 0-5VDC output 12-32VDC for 0-10VDC output 8-32VDC for 1-5VDC output 8-32VDC for 0.5-4.5VDC output
Output Load	≥ 4.7 kΩ for voltage output ≤ (Vsup-8)/20mA for current supply
Output Response Time	<2 ms
Overvoltage Protection	36 VDC
Reverse Voltage Protection	Yes
Short Circuit Protection	Yes
Insulation Resistance	> 100 MΩ at 500V
EMC	IEC 61326-1 and EN 61326-2-3
Dielectric Strength	500 VAC
Enhanced Radiated Immunity	100V/m (80-200MHz) 200V/m (200-2700MHz)
Enhanced ESD	±8KV Contact; ±15KV Air

Physical

Proof Pressure	2X full scale pressure ⁽¹⁾
Burst Pressure	20X for full scale pressure = 50-100 bar 10X for full scale pressure = 101-400 bar 4000 bar for full scale pressure = 401-600 bar
Random Vibration	IEC 60068-2-6, 30g (10...2000Hz)
Mechanical Shock	EN 60068-2-27, 500g
Drop (any Axis)	1m
Ingress Protection	IP65 - IP67 (see Connector Options)
Media Compatibility	Fluids and Gases compatible with 17-4PH stainless steel

Performance

Accuracy (Best Fit Straight Line)⁽²⁾	±0.25%FS @25°C
Accuracy (Total Error Band)⁽³⁾	+/-1.5%FS @-20° to 85°C
Operating Endurance	>10M cycles
Operating Ambient Temperature	-40° to +100°C
Operating Media Temperature	-40° to +125°C
Storage Temperature	-40° to +125°C ⁽⁴⁾



DIMENSIONS

All dimensions are in millimeters

Pressure Port

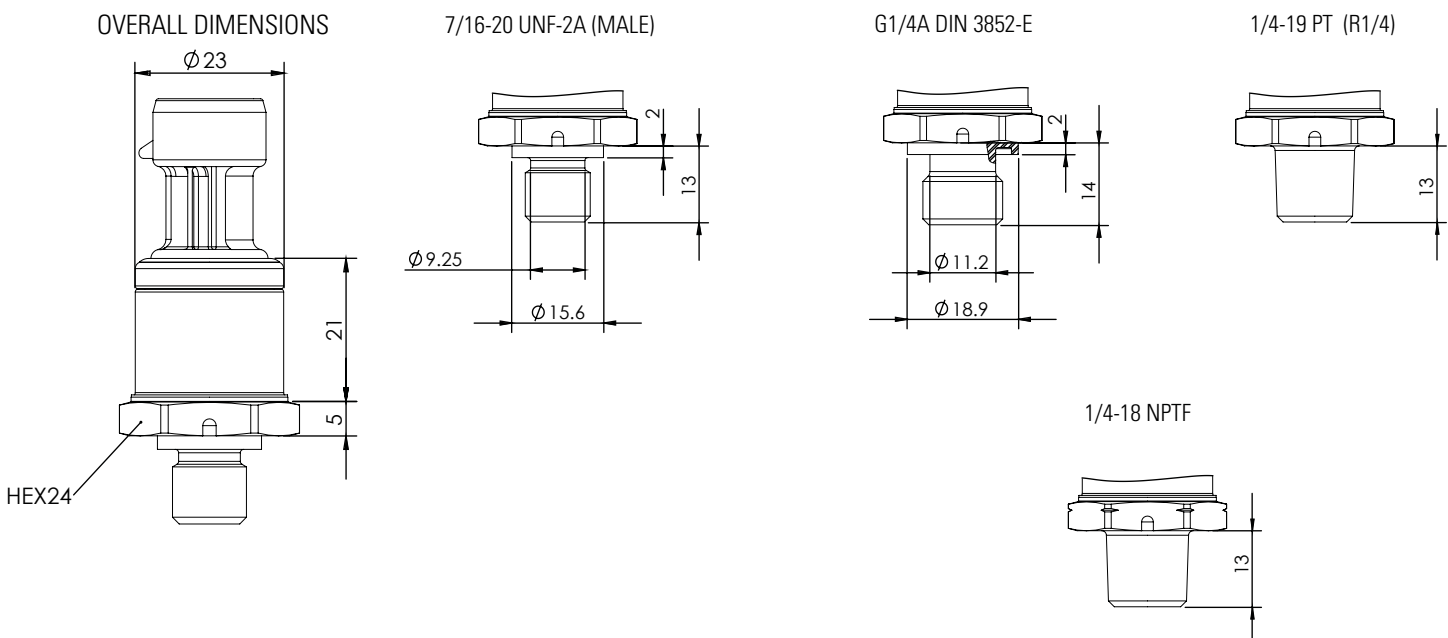

Electrical Connector

PACKARD METRI-PACK 150
IP67



Output Type	PIN A	PIN B	PIN C
Voltage	V-	V+	Vout
Current	Iout	V+	...

M12x1 4-POLE
IP67

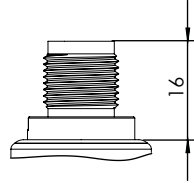

Output Type	PIN 1	PIN 2	PIN 3	PIN 4
Voltage	V+	...	V-	Vout
Current	V+	...	Iout	...

A: DIN 175301-803 FORM A(18mm)
IP65

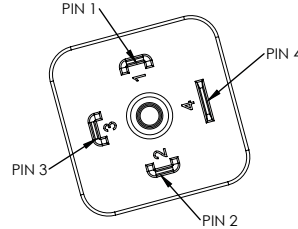
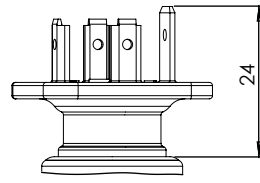

Output Type	PIN 1	PIN 2	PIN 3	PIN 4
Voltage	V+	V-	Vout	...
Current	V+	Iout

DEUTSCH DT04-3P
IP67

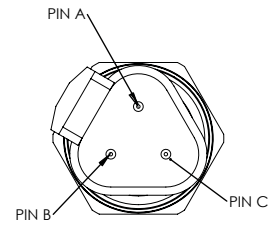
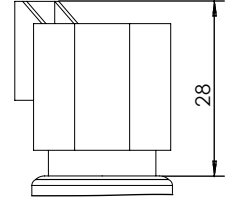

Output Type	PIN A	PIN B	PIN C
Voltage	V+	V-	Vout
Current	V+	Iout	...

FLY LEAD WITH HARNESS
IP67



Output Type	RED	BLACK	WHITE
Voltage	V+	V-	Vout
Current	V+	Iout	...



ORDERING OPTIONS

Example : PTE7100-31AA-1A250BS

PTE7100 with G1/4A thread with external FKM o-ring seal, DIN A connector, 4-20

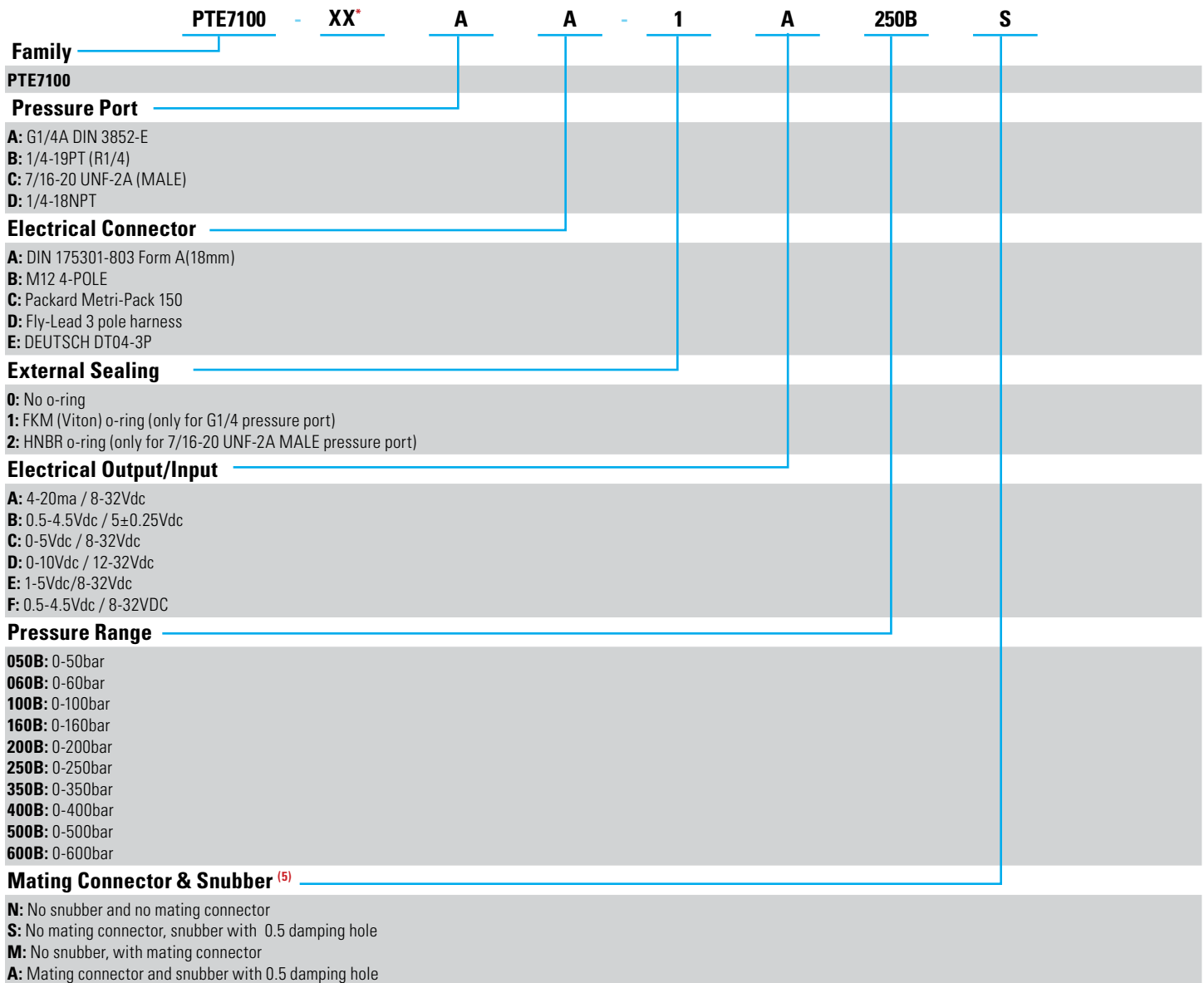

*Factory Specified



AGENCY APPROVALS & CERTIFICATIONS

