

PTFC210202FC

Thermally-Enhanced High Power RF LDMOS FET
28 W, 28 V, 1800 – 2200 MHz

Description

The PTFC210202FC integrates two independent 10-watt LDMOS FETs and is designed for use in cellular amplifier applications in the 2110 to 2170 MHz frequency band. Manufactured with Wolfspeed's advanced LDMOS process, this device provides excellent thermal performance and superior reliability.

PTFC210202FC
Package H-37248-4

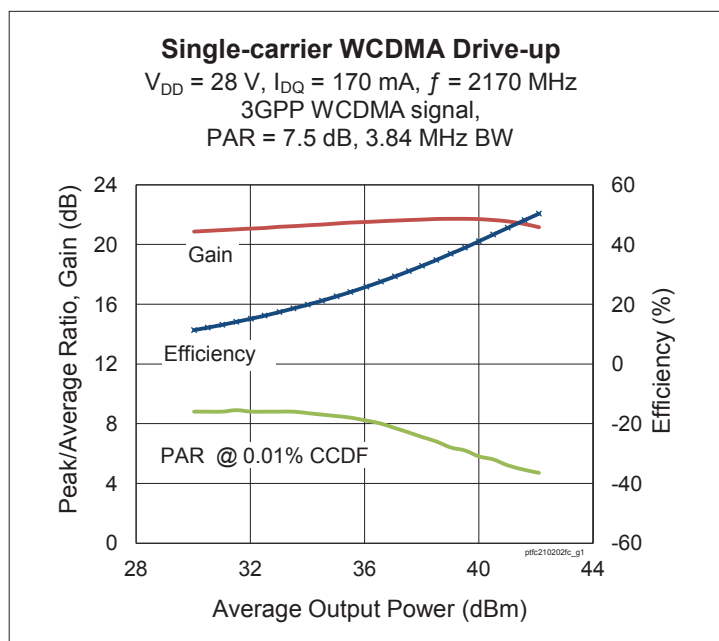

Features

- Input matched
- Typical CW performance, 2170 MHz, 28 V, combined outputs
 - Output power at $P_{1dB} = 28\text{ W}$
 - Efficiency = 62%
 - Gain = 20.9 dB
- Capable of handling 10:1 VSWR @28 V, 28 W (CW) output power
- Integrated ESD protection : Human Body Model, Class 1C (per JESD22-A114)
- Low thermal resistance
- Pb-free and RoHS compliant

RF Characteristics

Single-carrier WCDMA Specifications (tested in Wolfspeed test fixture)

$V_{DD} = 28\text{ V}$, $I_{DQ} = 170\text{ mA}$, $P_{OUT} = 5\text{ W avg}$, $f_1 = 2160\text{ MHz}$, $f_2 = 2170\text{ MHz}$, 3GPP signal, channel bandwidth = 3.84 MHz, peak/average = 8 dB @ 0.01% CCDF

Characteristic	Symbol	Min	Typ	Max	Unit
Linear Gain	G_{ps}	20	21	—	dB
Drain Efficiency	η_D	26.5	29	—	%
Adjacent Channel Power Ratio	ACPR	—	-31	-28	dBc

All published data at $T_{CASE} = 25^\circ\text{C}$ unless otherwise indicated

ESD: Electrostatic discharge sensitive device—observe handling precautions!

DC Characteristics (each side)

Characteristic	Conditions	Symbol	Min	Typ	Max	Unit
Drain-Source Breakdown Voltage	$V_{GS} = 0\text{ V}, I_{DS} = 10\text{ mA}$	$V_{(BR)DSS}$	65	—	—	V
Drain Leakage Current	$V_{DS} = 28\text{ V}, V_{GS} = 0\text{ V}$	I_{DSS}	—	—	0.1	μA
	$V_{DS} = 63\text{ V}, V_{GS} = 0\text{ V}$	I_{DSS}	—	—	1.0	μA
Gate Leakage Current	$V_{GS} = 10\text{ V}, V_{DS} = 0\text{ V}$	I_{GSS}	—	—	1	μA
On-State Resistance	$V_{GS} = 10\text{ V}, V_{DS} = 0.1\text{ V}$	$R_{DS(on)}$	—	0.05	—	Ω
Operating Gate Voltage	$V_{DS} = 28\text{ V}, I_{DQ} = 0.17$	V_{GS}	2.40	2.70	3.05	V

Maximum Ratings

Parameter	Symbol	Value	Unit
Drain-Source Voltage	V_{DSS}	65	V
Gate-Source Voltage	V_{GS}	-6 to +10	V
Operating Voltage	V_{DD}	0 to +32	V
Junction Temperature	T_J	225	$^{\circ}\text{C}$
Storage Temperature Range	T_{STG}	-65 to +150	$^{\circ}\text{C}$
Thermal Resistance ($T_{CASE} = 70^{\circ}\text{C}, 25\text{ W CW}$)	$R_{\theta JC}$	2.2	$^{\circ}\text{C/W}$

Ordering Information

Type and Version	Order Code	Package Description	Shipping
PTFC210202FC V1 R0	PTFC210202FC-V1-R0	H-37248-4, earless flange	Tape & Reel, 50 pcs
PTFC210202FC V1 R250	PTFC210202FC-V1-R250	H-37248-4, earless flange	Tape & Reel, 250 pcs

Typical Performance (data taken in a production test fixture)

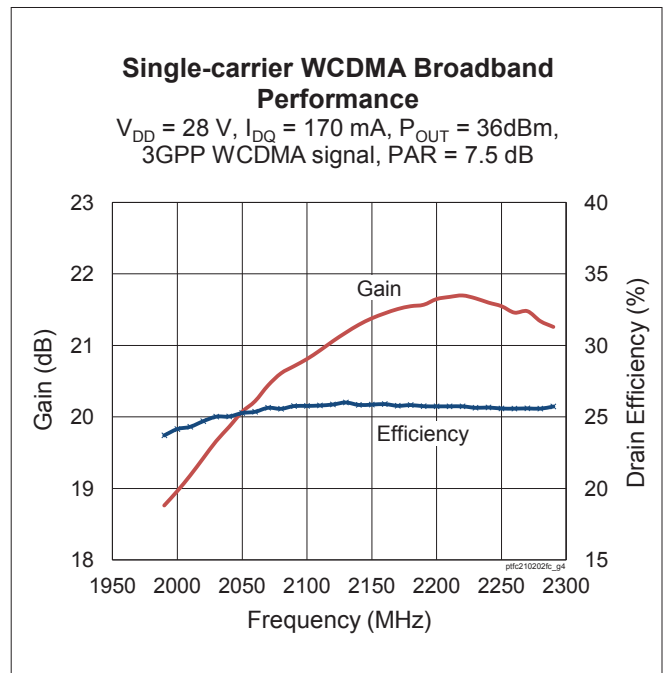
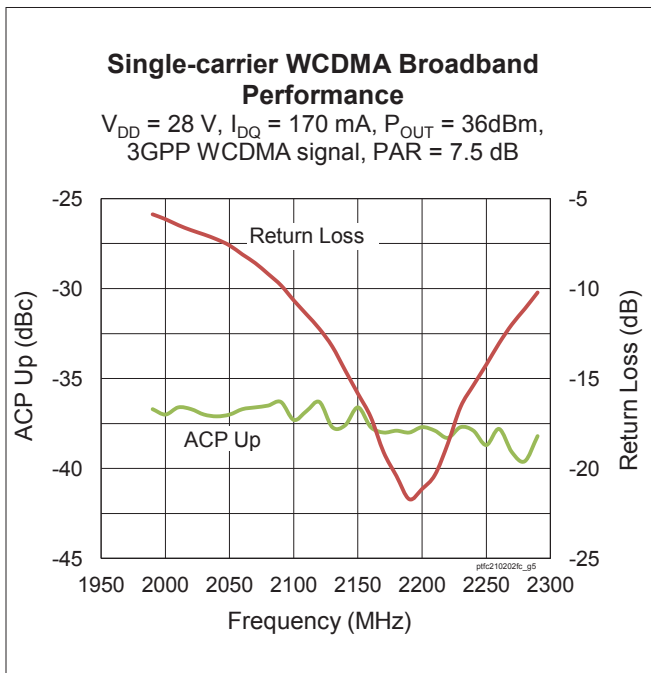
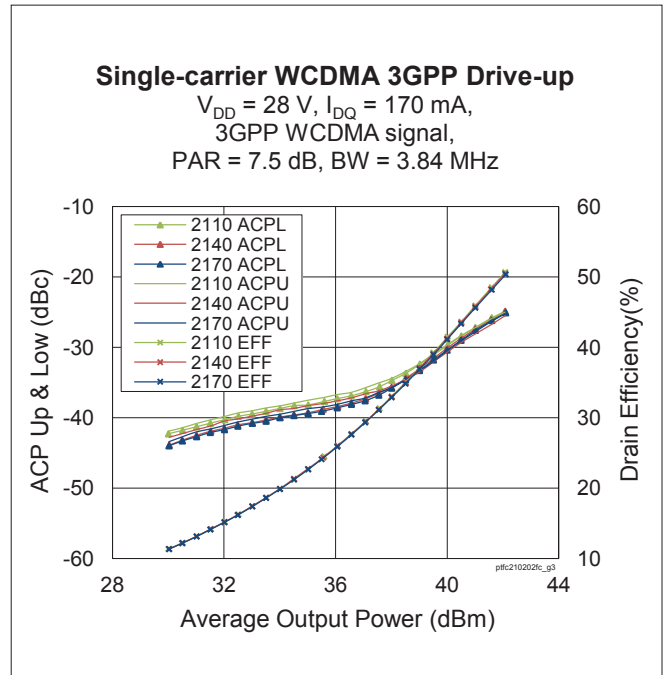
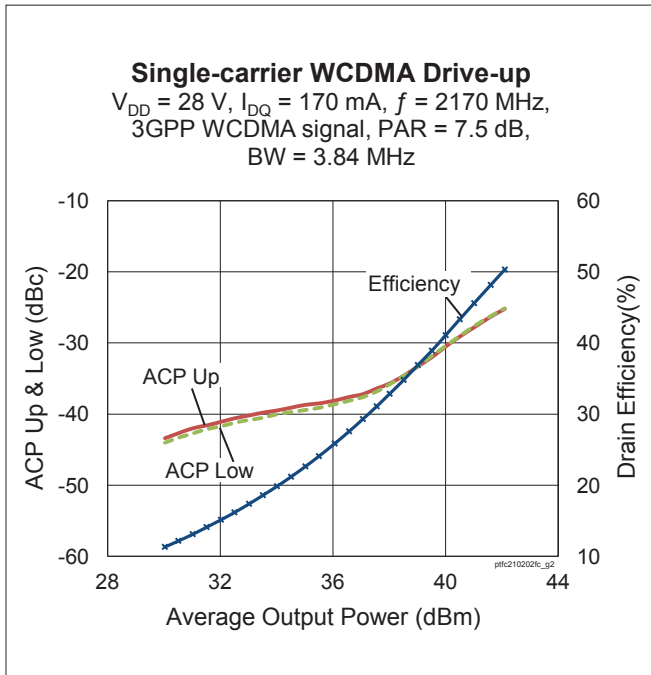



Typical Performance (cont.)

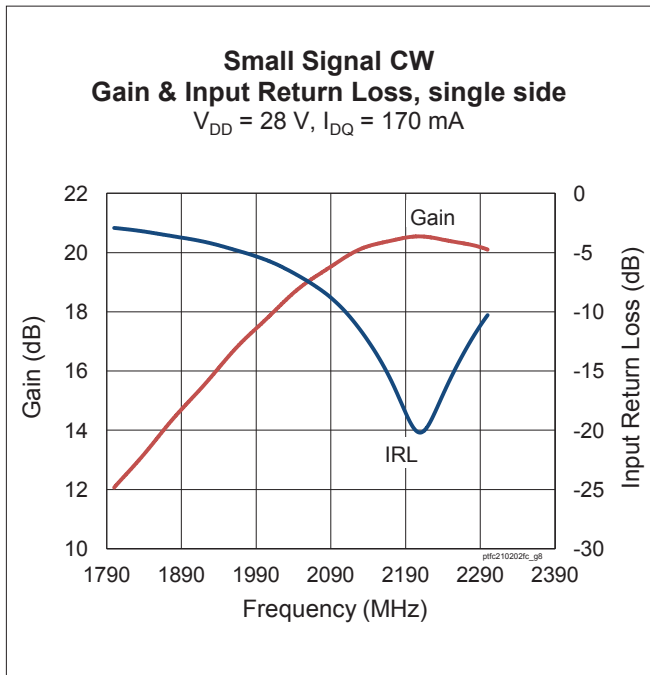
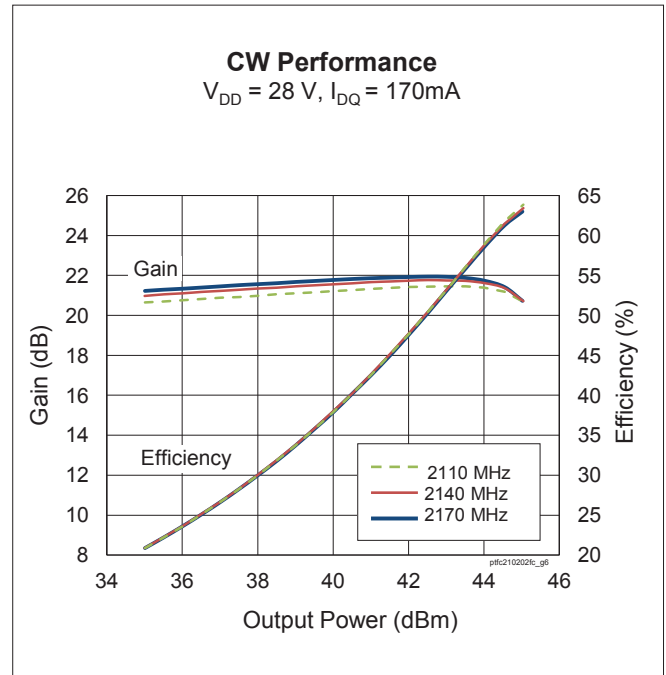
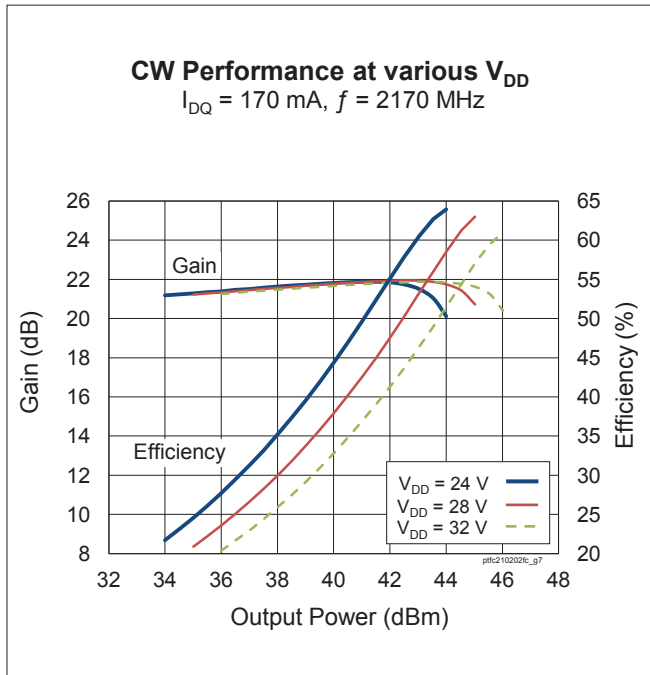

Broadband Circuit Impedance

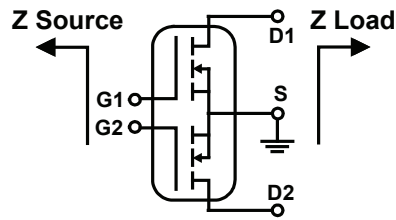

Frequency MHz	Z Source Ω		Z Load Ω	
	R	jX	R	jX
2110	4.86	-0.01	3.59	-2.65
2120	4.89	-0.01	3.63	-2.65
2130	4.92	-0.01	3.68	-2.66
2140	4.95	-0.01	3.72	-2.68
2150	4.98	-0.02	3.76	-2.69
2160	5.00	-0.02	3.81	-2.71
2170	5.03	-0.03	3.85	-2.73

Load Pull Performance

Each Side Load Pull Performance – CW signal; $V_{DD} = 28\text{ V}$, 85 mA

Freq [MHz]	Z_s [Ω]	P_{1dB}										
		Max Output Power					Max PAE					
		Z_l [Ω]	Gain [dB]	P_{OUT} [dBm]	P_{OUT} [W]	PAE [%]	Z_l [Ω]	Gain [dB]	P_{OUT} [dBm]	P_{OUT} [W]	PAE [%]	
2110	15.9 - j19.7	6.7 - j5.6	21.7	42.67	18.5	58.7	5.3 - j2.3	23.7	41.25	13.3	67.8	
2140	15.7 - j18.8	7.6 - j4.9	22.3	42.16	16.4	60.5	4.9 - j2.3	24.1	40.89	12.3	67.3	
2170	17.1 - j17.7	7.0 - j5.7	22.1	42.08	16.2	59.2	4.8 - j2.9	23.9	40.87	12.2	66.6	



Reference Circuit

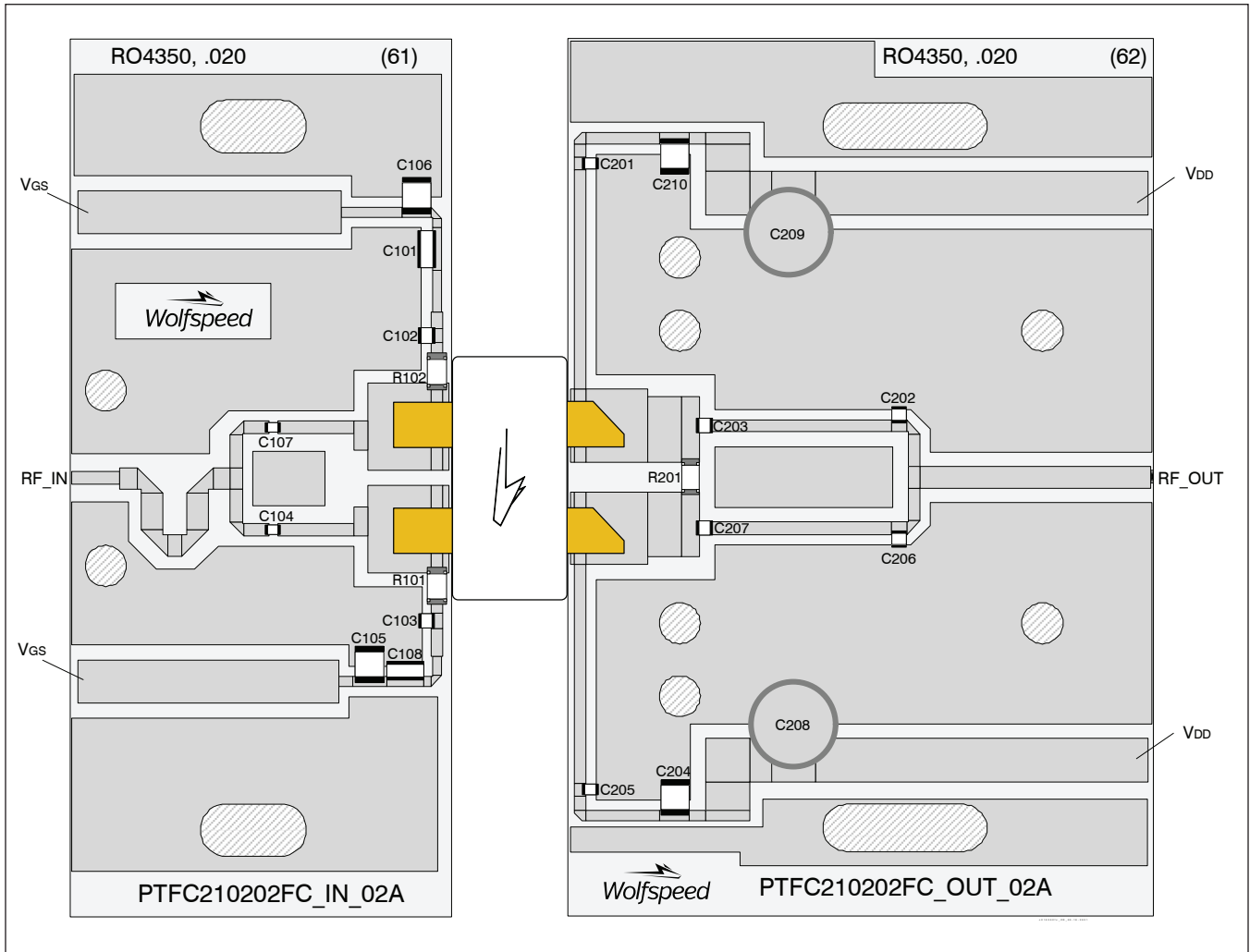

Reference circuit assembly diagram (not to scale)

Reference Circuit (cont.)**Reference Circuit Assembly**

DUT	PTFC210202FC
Test Fixture Part No.	LTN/PTFC210202FC-V1
PCB	Rogers 4350, 0.508 mm [0.020"] thick, 2 oz. copper, $\epsilon_r = 3.66$
Find Gerber files for this test fixture on the Wolfspeed Web site at http://www.wolfspeed.com/RF	

Components Information

Component	Description	Suggested Manufacturer	P/N
Input			
C101, C108	Capacitor, 10 μ F	TDK Corporation	C5750X5R1H106K230KA
C102, C103	Chip capacitor, 20 pF	ATC	ATC100A200JW150XB
C104, C107	Chip capacitor, 5.1 pF	ATC	ATC100A5R1CW250XT
C105, C106	Chip capacitor, 10 μ F	Taiyo Yuden	UMK325C7106MM-T
R101, R102	Resistor, 10 Ω	Panasonic Electronic Components	ERJ-8GEYJ100V
Output			
C201, C205	Chip capacitor, 20 pF	ATC	ATC100A200JW250XT
C202, C203, C206, C207	Chip capacitor, 1.6 pF	ATC	ATC800A1R6BT250XT
C204, C210	Chip capacitor, 10 μ F	Taiyo Yuden	UMK325C7106MM-T
C208, C09	Capacitor, 100 μ F	Panasonic Electronic Components	ECA-1HHG101
R201	Resistor, 10 Ω	ATC	CR11206T0100J

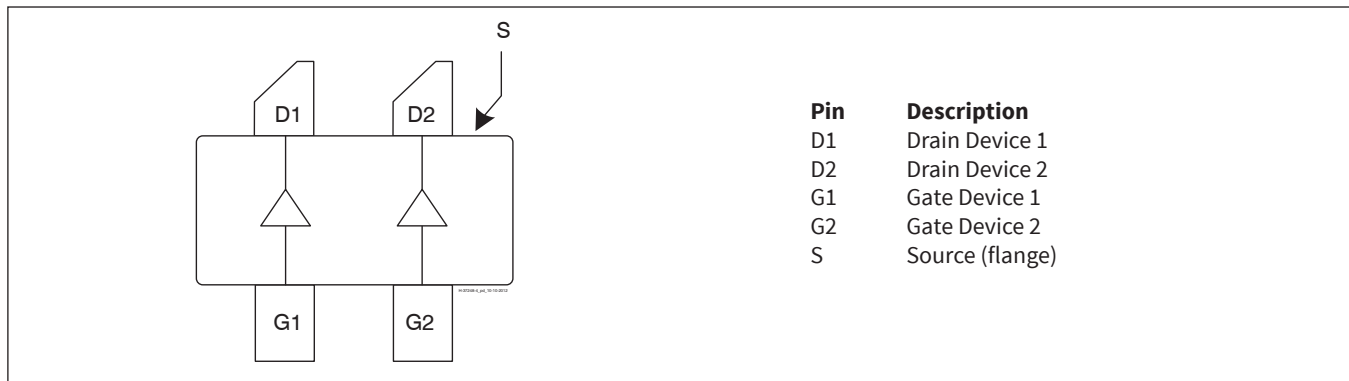
Pinout Diagram (top view)

Lead connections for PTFC210202FC

Package Outline Specifications

