

PTFC260202FC

Thermally-Enhanced High Power RF LDMOS FET 25 W, 28 V, 2495 – 2690 MHz

Description

The PTFC260202FC integrates two independent 10-watt LDMOS FETs and is designed for use in cellular amplifier applications in the 2495 to 2690 MHz frequency band. Manufactured with Wolfspeed's advanced LDMOS process, this device provides excellent thermal performance and superior reliability.

PTFC260202FC
Package H-37248-4

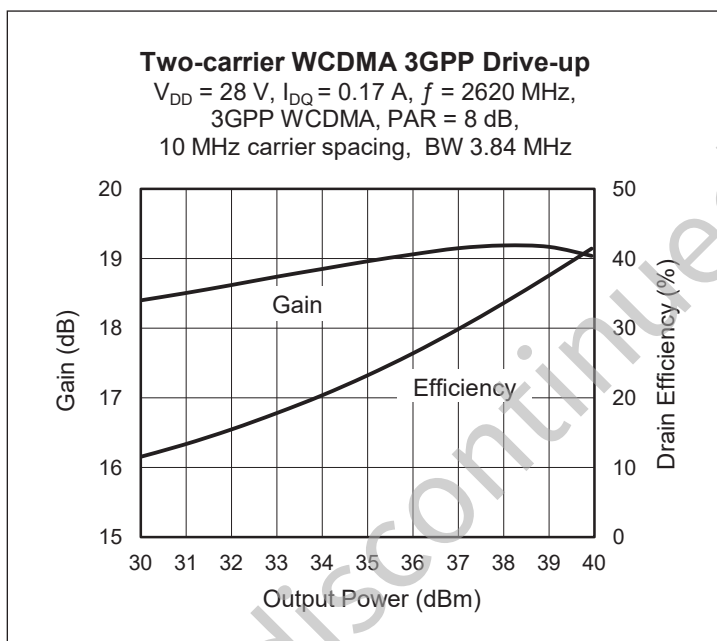
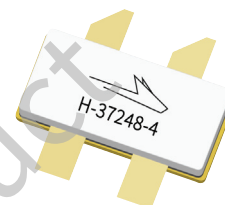

Features

- Broadband input matching
- Typical CW performance, 2620 MHz, 28 V
 - Output power at $P_{1dB} = 25\text{ W}$
 - Efficiency = 57%
 - Linear Gain = 19.4 dB
- Capable of handling 10:1 VSWR @28 V, 25 W (CW) output power
- Integrated ESD protection
- Human Body Model Class 1B (per ANSI/ESDA/ JEDEC JS-001)
- Low thermal resistance
- Pb-free and RoHS compliant

RF Characteristics

Two-carrier WCDMA Specifications (tested in Wolfspeed test fixture)

$V_{DD} = 28\text{ V}$, $I_{DQ} = 170\text{ mA}$, $P_{OUT} = 5\text{ W avg}$, $f_1 = 2615\text{ MHz}$, $f_2 = 2625\text{ MHz}$, 3GPP signal, channel bandwidth = 3.84 MHz, peak/average = 8 dB @ 0.01% CCDF

Characteristic	Symbol	Min	Typ	Max	Unit
Linear Gain	G_{ps}	19	20	—	dB
Drain Efficiency	η_D	27.5	30	—	%
Intermodulation Distortion	IMD	—	-31.5	-30	dBc

All published data at $T_{CASE} = 25^\circ\text{C}$ unless otherwise indicated

ESD: Electrostatic discharge sensitive device—observe handling precautions!

DC Characteristics (single side)

Characteristic	Conditions	Symbol	Min	Typ	Max	Unit
Drain-Source Breakdown Voltage	$V_{GS} = 0\text{ V}, I_{DS} = 10\text{ mA}$	$V_{(BR)DSS}$	65	—	—	V
Drain Leakage Current	$V_{DS} = 28\text{ V}, V_{GS} = 0\text{ V}$	I_{DSS}	—	—	1	μA
	$V_{DS} = 63\text{ V}, V_{GS} = 0\text{ V}$	I_{DSS}	—	—	10	μA
On-State Resistance	$V_{GS} = 10\text{ V}, V_{DS} = 0.1\text{ V}$	$R_{DS(on)}$	—	0.05	—	Ω
Operating Gate Voltage	$V_{DS} = 28\text{ V}, I_{DQ} = 1.35\text{ A}$	V_{GS}	2.3	2.8	3.3	V
Gate Leakage Current	$V_{GS} = 10\text{ V}, V_{DS} = 0\text{ V}$	I_{GSS}	—	—	1	μA

Maximum Ratings

Parameter	Symbol	Value	Unit
Drain-Source Voltage	V_{DSS}	65	V
Gate-Source Voltage	V_{GS}	-6 to +10	V
Operating Voltage	V_{DD}	0 to +32	V
Junction Temperature	T_J	225	$^{\circ}\text{C}$
Storage Temperature Range	T_{STG}	-65 to +150	$^{\circ}\text{C}$
Thermal Resistance ($T_{CASE} = 70^{\circ}\text{C}, 25\text{ W CW}$)	$R_{\theta JC}$	2.2	$^{\circ}\text{C/W}$

Ordering Information

Type and Version	Order Code	Package Description	Shipping
PTFC260202FC V1 R0	PTFC260202FC-V1-R0	H-37248-4, earless flange	Tape & Reel, 50 pcs
PTFC260202FC V1 R250	PTFC260202FC-V1-R250	H-37248-4, earless flange	Tape & Reel, 250 pcs

Typical Performance (data taken in a production test fixture)

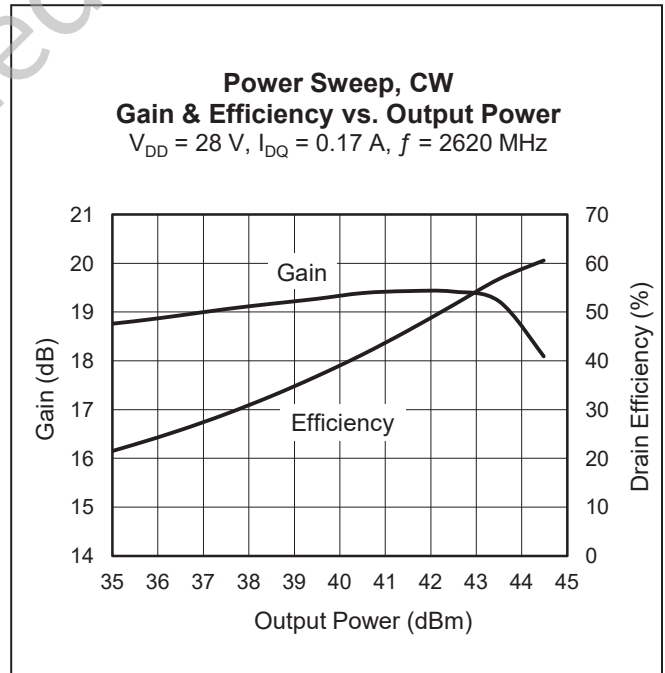
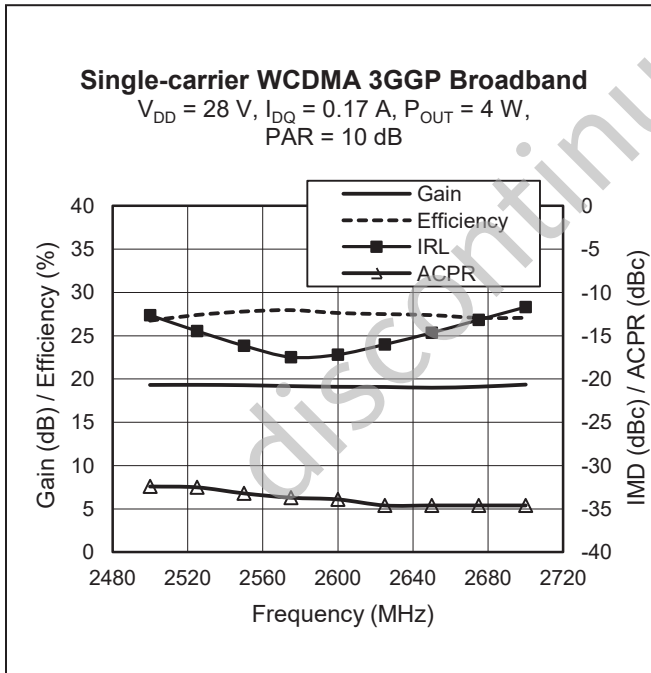
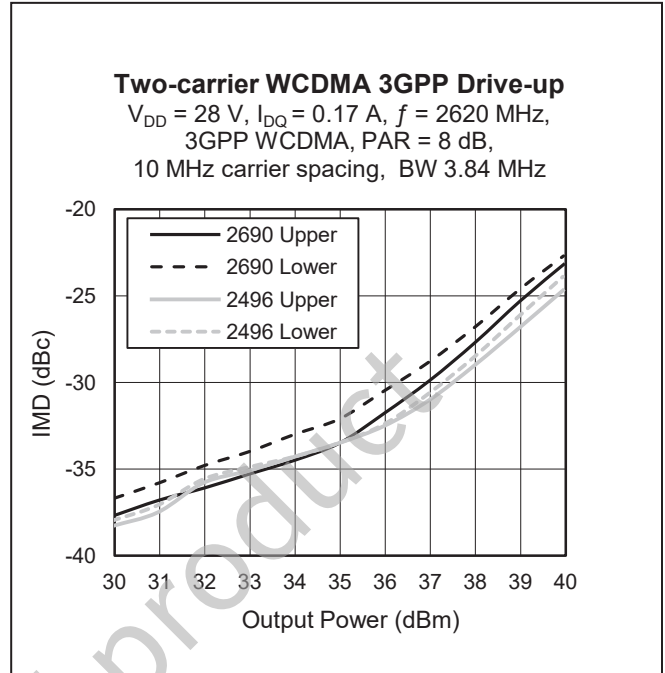
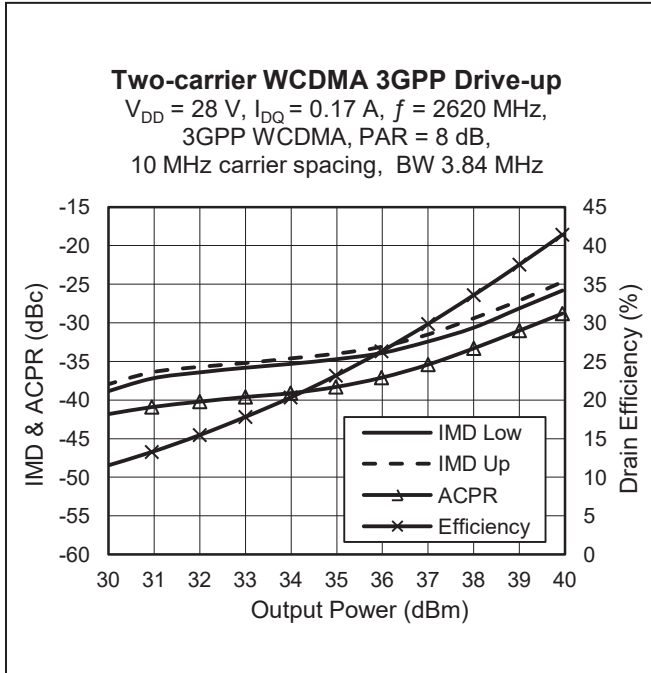

Broadband Circuit Impedance

Frequency MHz	Z Source Ω		Z Load Ω	
	R	jX	R	jX
2495	25.5	-18.0	8.4	-11.1
2533	24.7	-17.9	8.3	-11.2
2570	24.0	-17.8	8.3	-11.3
2620	23.1	-17.6	8.0	-11.4
2655	22.5	-17.4	7.9	-11.5
2690	22.0	-17.1	7.6	-11.6

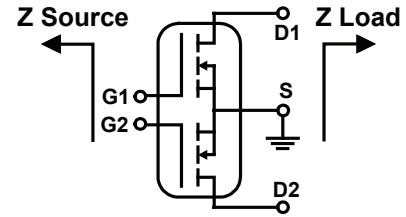

Reference Circuit

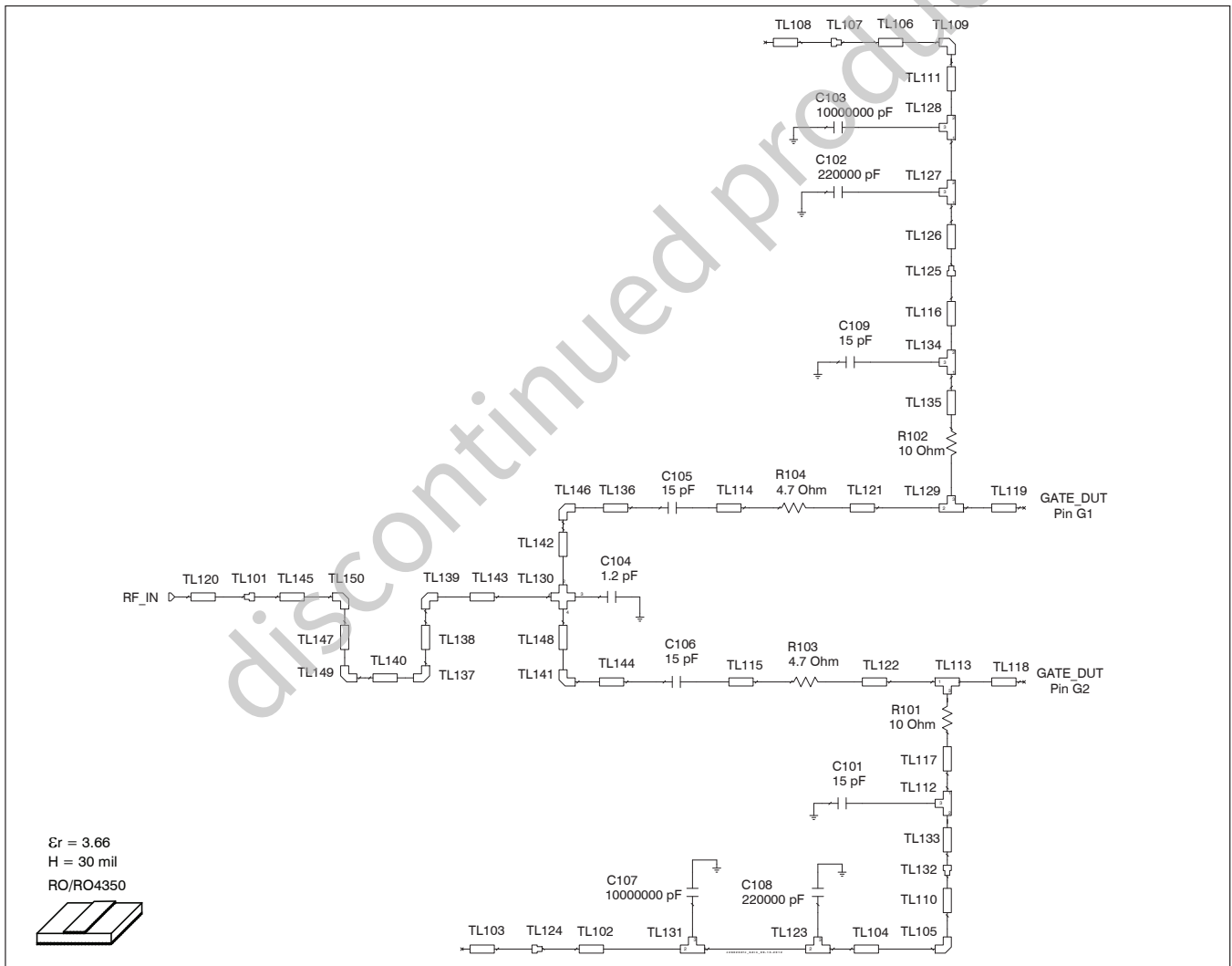

Reference circuit input schematic for $f = 2680 \text{ MHz}$

Reference Circuit

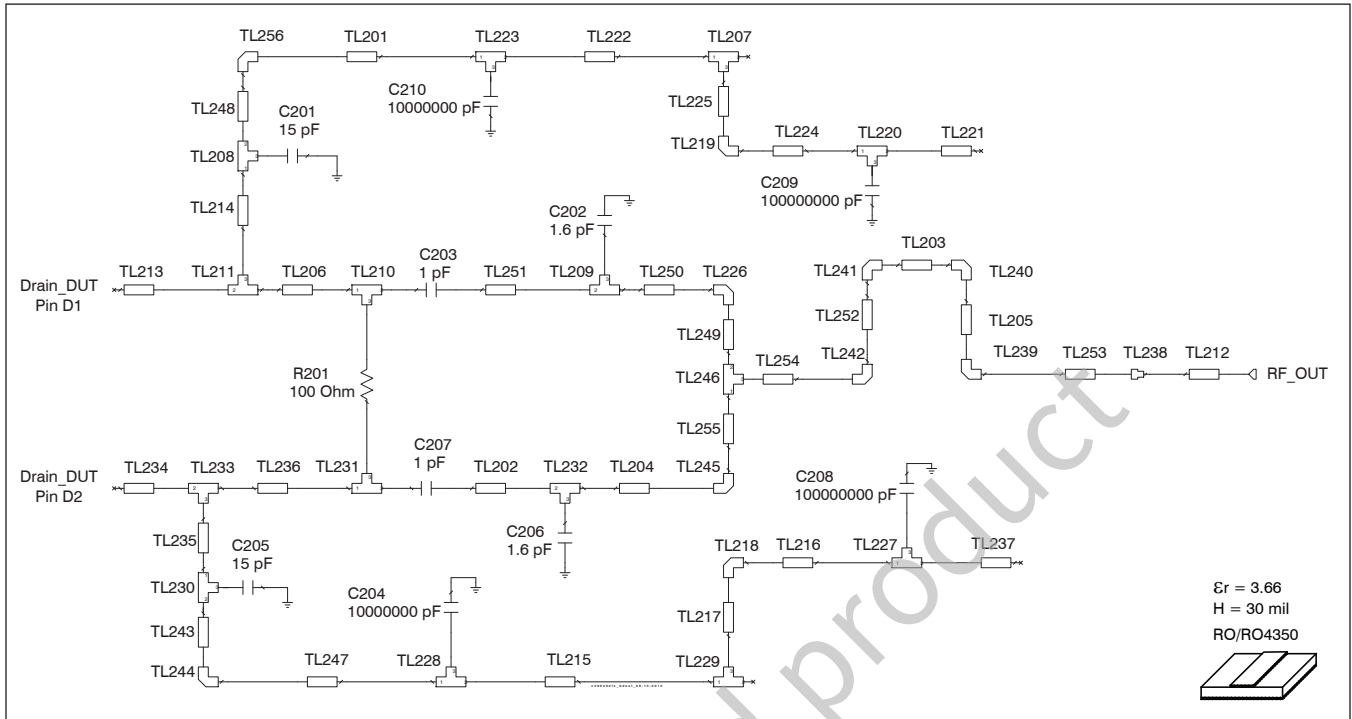

Reference circuit output schematic for $f = 2680$ MHz

discontinued product



Reference Circuit (cont.)

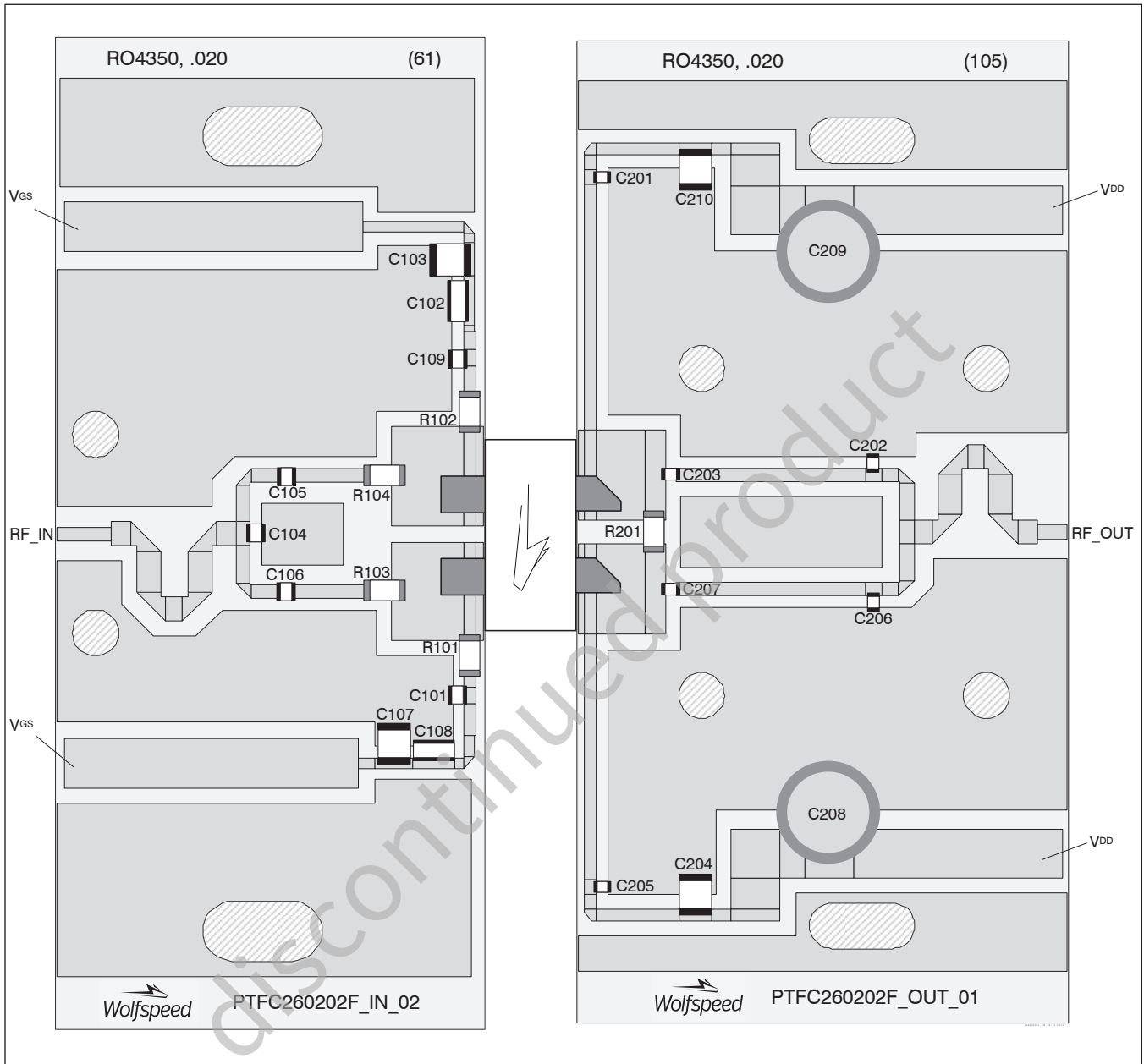

Reference circuit assembly diagram (not to scale)

Reference Circuit (cont.)**Reference Circuit Assembly**

DUT	PTFC260202FC
Test Fixture Part No.	LTN/PTFC260202FC
PCB	Rogers 4350, 0.508 mm [0.020"] thick, 2 oz. copper, $\epsilon_r = 3.66$, $f = 2680$ MHz
Find Gerber files for this test fixture on the Wolfspeed Web site at http://www.wolfspeed.com/RF	

Components Information

Component	Description	Suggested Manufacturer	P/N
Input			
C101, C105, C106, C109	Chip capacitor, 15 pF	ATC	ATC800A150GT250X
C102, C108	Capacitor, 220000 pF	Digi-Key	445-1814-2-ND
C103, C107	Chip capacitor, 10 μ F	Digi-Key	587-1818-2-ND
C104	Chip capacitor, 1.2 pF	ATC	ATC800A1R2GT250X
R101, R102	Resistor, 10 Ω	Digi-Key	P10ECT-ND
R103, R104	Resistor, 4.7 Ω	Digi-Key	P4.7ECT-ND
Output			
C201, C205	Chip capacitor, 15 pF	ATC	ATC800A150GT250X
C202, C206	Chip capacitor, 1.6 pF	ATC	ATC800A1R6BT250X
C203, C207	Chip capacitor, 1 pF	ATC	ATC800A1R0BT250X
C204, C210	Chip capacitor, 10 μ F	Digi-Key	587-1818-2-ND
C208, C209	Capacitor, 100 μ F	Digi-Key	P5571-ND
R201	Resistor, 100 Ω	Digi-Key	CR11206T0100J

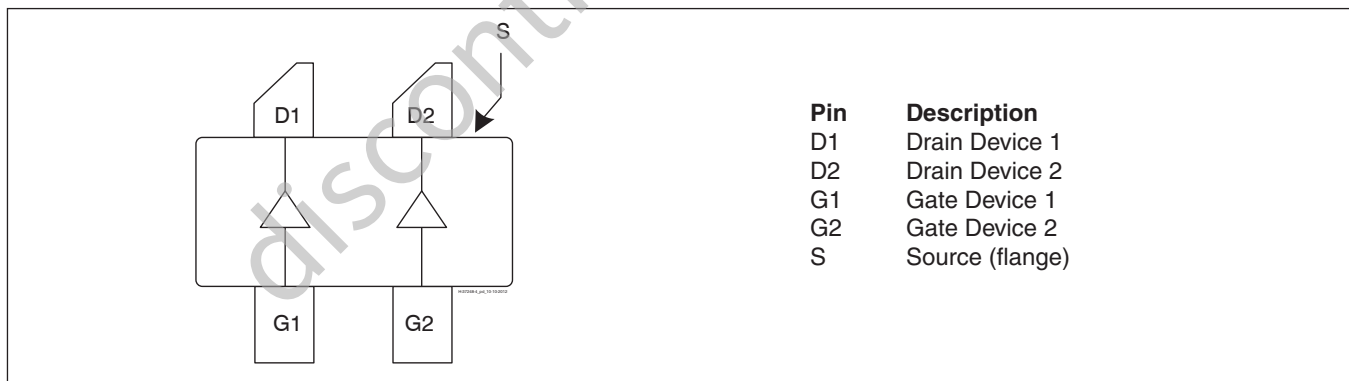
Pinout Diagram (top view)

Lead connections for PTFC260202FC

Package Outline Specifications

