

PTFC270101M

High Power RF LDMOS Field Effect Transistor
10 W, 28 V, 900 – 2700 MHz

Description

The PTFC270101M is an unmatched 10-watt LDMOS FET suitable for power amplifier applications with frequencies from 900 MHz to 2700 MHz. This LDMOS transistor offers excellent gain, efficiency and linearity performance in a small overmolded plastic package.

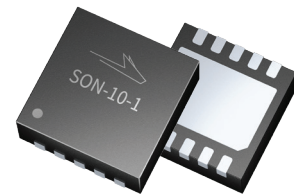

PTFC270101M
Package PG-SON-10

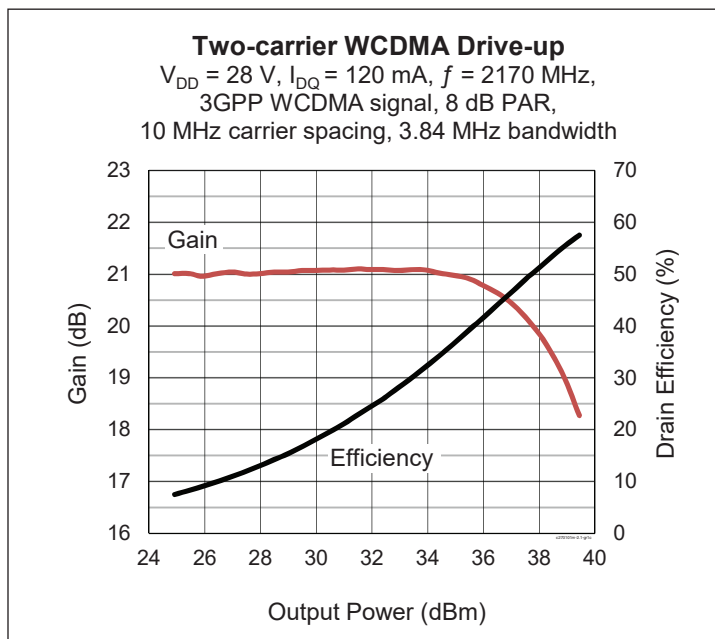

Features

- Unmatched input and output
- Typical CW performance, 2170 MHz, 28 V
 - Output power @ $P_{1dB} = 10\text{ W}$
 - Gain = 20 dB
 - Efficiency = 60%
- Typical two-carrier WCDMA performance, 2170 MHz, 28 V, 8 dB PAR
 - Output power = 1.3 W avg
 - Gain = 21 dB
 - Efficiency = 21%
 - ACPR = -44.9 dBc @ 5 MHz
- Capable of handling 10:1 VSWR @ 28 V, 10 W (CW) output power
- Integrated ESD protection
- Pb-free and RoHS compliant

RF Characteristics

Two-carrier WCDMA Specifications (tested in Wolfspeed production test fixture)

$V_{DD} = 28\text{ V}$, $I_{DQ} = 120\text{ mA}$, $P_{OUT} = 2.4\text{ W avg}$, $f = 2170\text{ MHz}$

3GPP WCDMA signal, 3.84 MHz channel bandwidth, 8 dB peak/average @ 0.01% CCDF

Characteristic	Symbol	Min	Typ	Max	Unit
Gain	G_{ps}	19.5	20.5	—	dB

All published data at $T_{CASE} = 25^\circ\text{C}$ unless otherwise indicated

ESD: Electrostatic discharge sensitive device—observe handling precautions!

RoHS
COMPLIANT

DC Characteristics

Characteristic	Conditions	Symbol	Min	Typ	Max	Unit
Drain-Source Breakdown Voltage	$V_{GS} = 0\text{ V}, I_{DS} = 10\text{ mA}$	$V_{(BR)DSS}$	65	—	—	V
Drain Leakage Current	$V_{DS} = 28\text{ V}, V_{GS} = 0\text{ V}$	I_{DSS}	—	—	1	μA
	$V_{DS} = 63\text{ V}, V_{GS} = 0\text{ V}$	I_{DSS}	—	—	10	μA
Gate Leakage Current	$V_{GS} = 10\text{ V}, V_{DS} = 0\text{ V}$	I_{GSS}	—	1	—	μA
On-State Resistance	$V_{GS} = 10\text{ V}, V_{DS} = 0.1\text{ V}$	$R_{DS(on)}$	—	1	—	Ω
Operating Gate Voltage	$V_{DS} = 28\text{ V}, I_{DQ} = 120\text{ mA}$	V_{GS}	2.2	2.7	3.2	V

Maximum Ratings

Parameter	Symbol	Value	Unit
Drain-Source Voltage	V_{DSS}	65	V
Gate-Source Voltage	V_{GS}	-6 to +10	V
Operating Voltage	V_{DD}	0 to +32	V
Junction Temperature	T_J	225	$^{\circ}\text{C}$
Storage Temperature Range	T_{STG}	-65 to +150	$^{\circ}\text{C}$
Thermal Resistance ($T_{CASE} = 70^{\circ}\text{C}, 12\text{ W CW}$)	$R_{\theta JC}$	4.04	$^{\circ}\text{C/W}$

Moisture Sensitivity Level

Level	Test Standard	Package Temperature	Unit
3	IPC/JEDEC J-STD-020	260	$^{\circ}\text{C}$

ESD Ratings

Test Type	Rated Class	Standard
Human Body Model (HBM)	1B	ANSI/ESDA/JEDEC JS-001
Charge Device Model (CDM)	II	JESD 22-C101

Ordering Information

Type	Order Code	Package and Description	Shipping
PTFC270101M V1 R1K	PTFC270101M-V1-R1K	PG-SON-10, molded plastic, SMD	Tape & Reel, 1000 pcs

Evaluation Boards

Order Code	Frequency	Description
LTN/PTFC270101M V1	2110 – 2170 MHz	Class AB with combined outputs, R04360, 0.508 mm thick
LTN/PTFC270101M E3	2620 – 2690 MHz	Class AB with combined outputs, R04360, 0.508 mm thick
LTN/PTFC270101M E4	920 – 960 MHz	Class AB with combined outputs, R04360, 0.508 mm thick

Find Gerber files for these reference fixtures on the Wolfspeed Web site at www.wolfspeed.com/RF

See next page for Typical RF Performance



Typical RF Performance, 2110 – 2170 MHz (data taken in production test fixture)

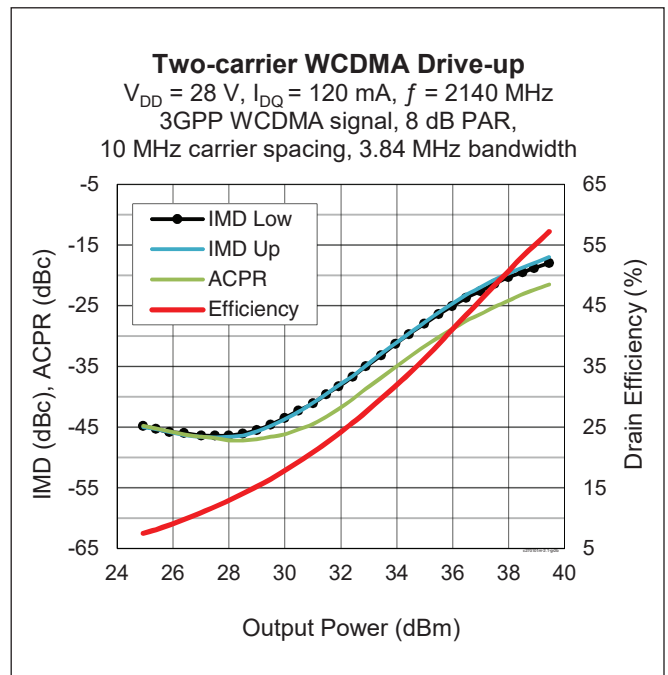
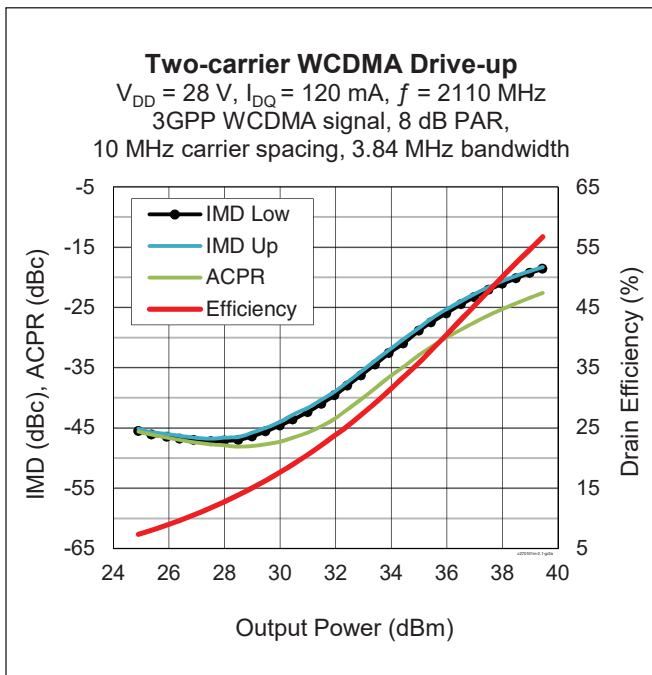
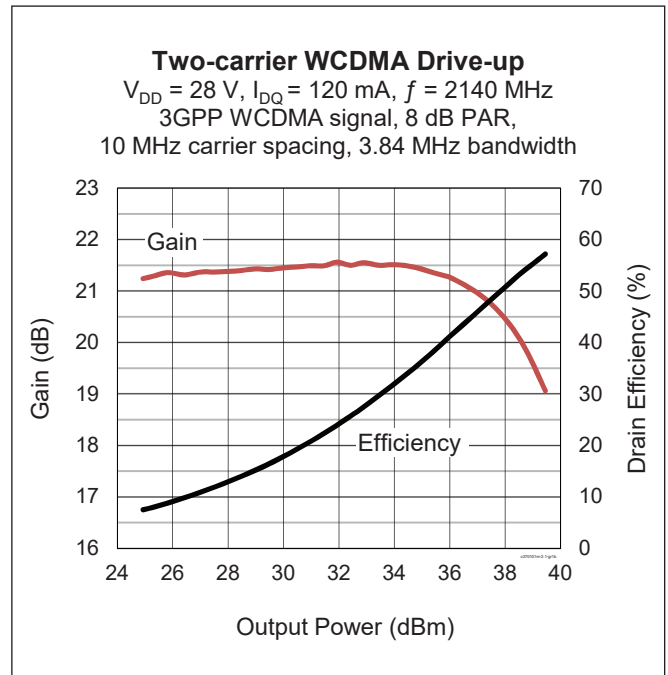
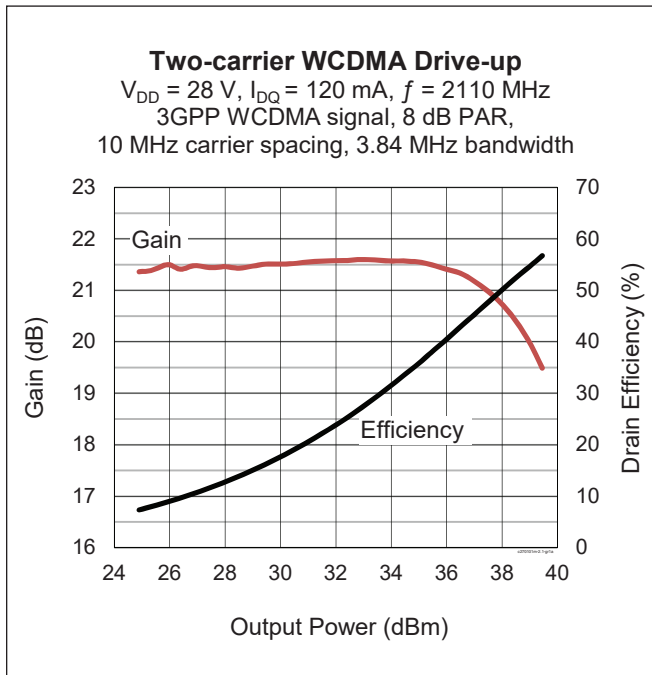

Typical RF Performance, 2110 – 2170 MHz (cont.)

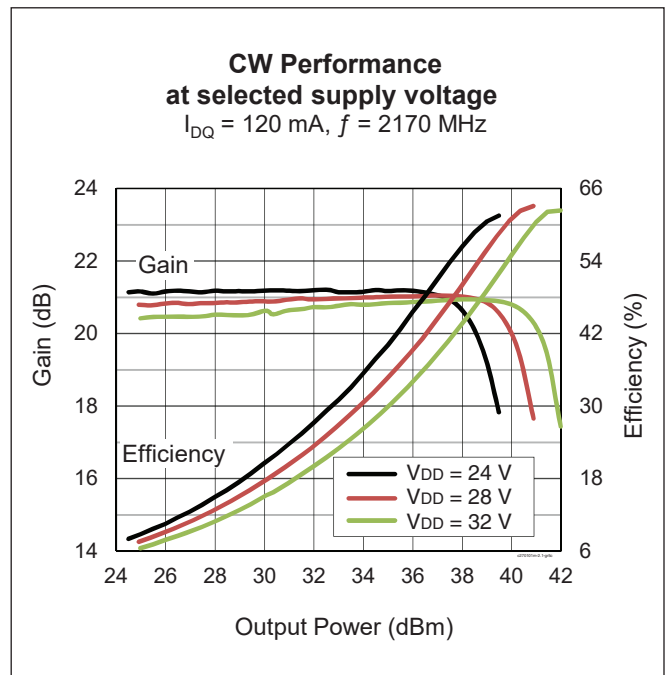
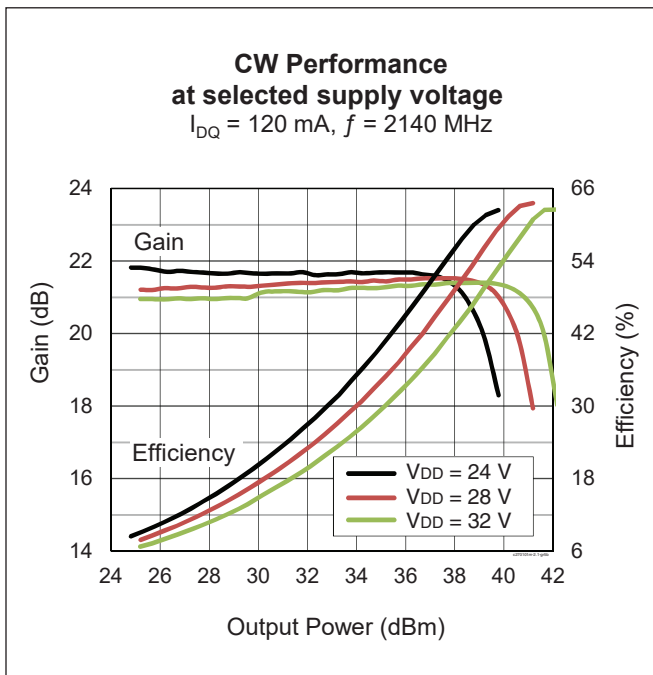
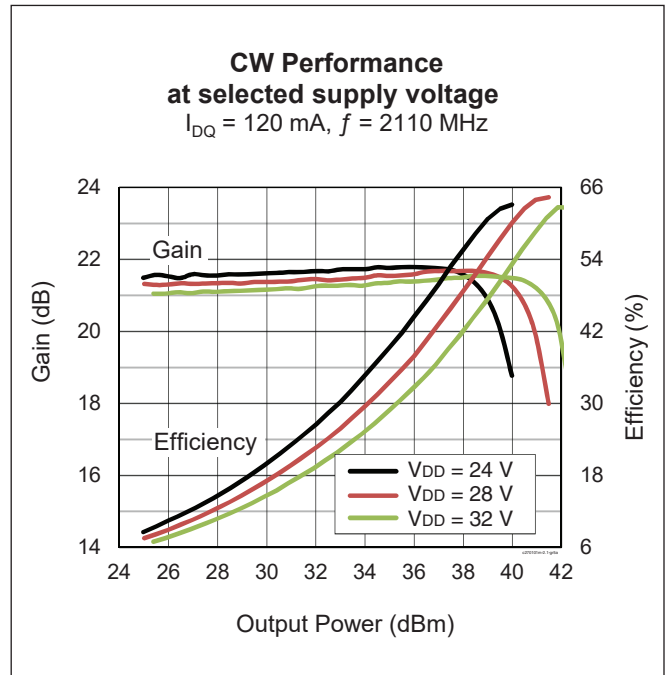
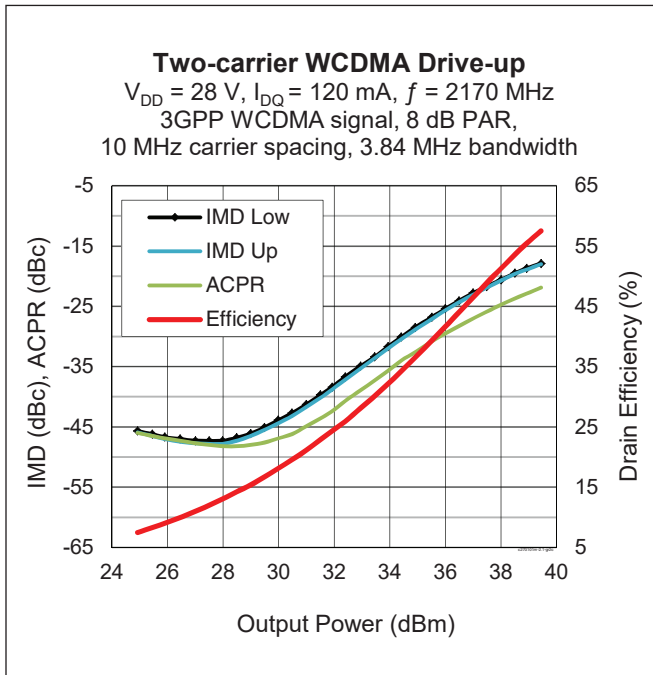

Typical RF Performance, 2110 – 2170 MHz (cont.)

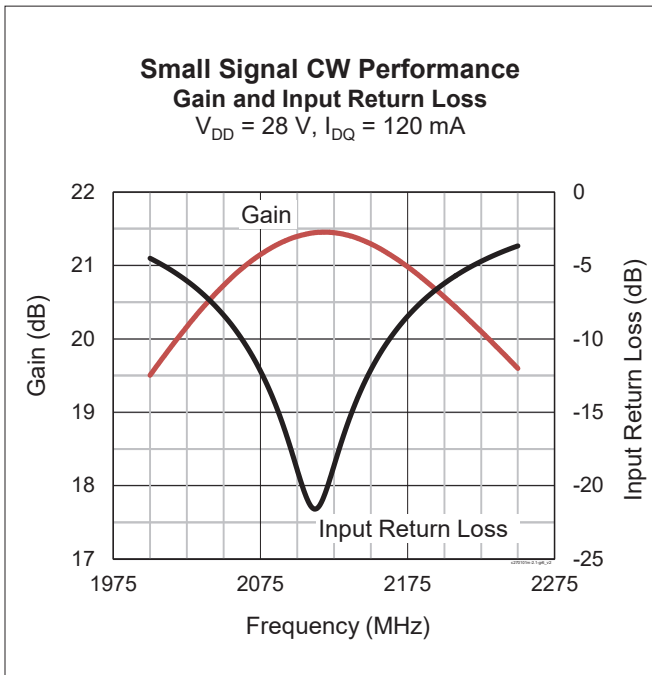
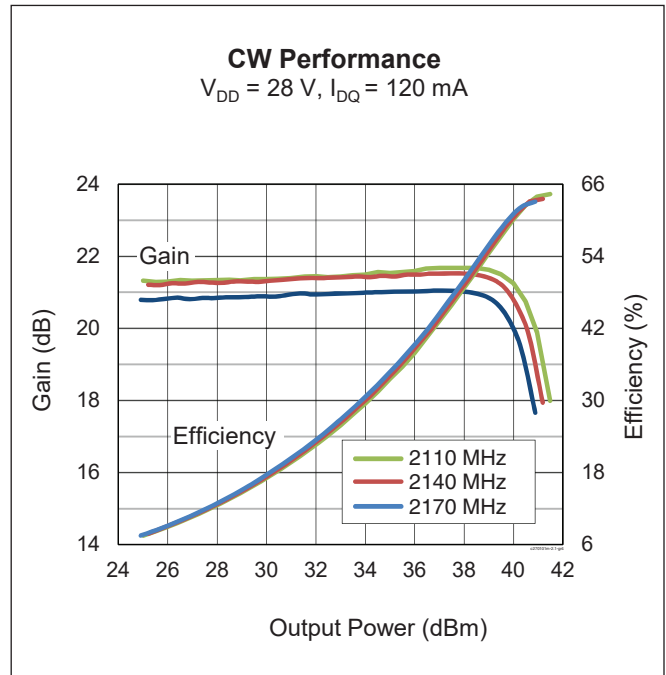
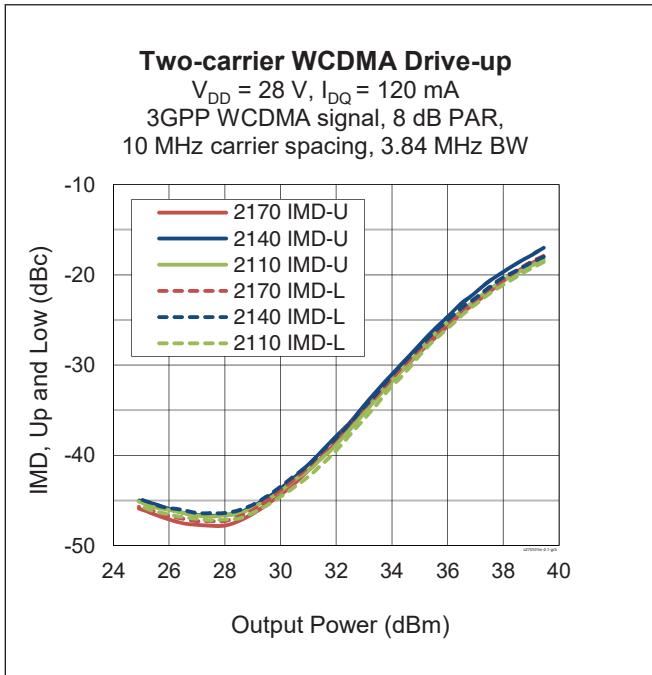

Broadband Circuit Impedance

Freq [MHz]	Z Source Ω		Z Load Ω	
	R	jX	R	jX
2110	2.1	-6.7	5.6	-6.1
2140	2.1	-6.5	5.6	-5.8
2170	2.1	-6.3	5.6	-5.5

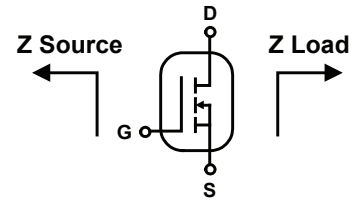

Load Pull Performance

Pulsed CW signal: 160 μ sec, 10% duty cycle; 28 V, 120 mA

Class AB		P _{1dB}									
		Max Output Power					Max PAE				
Freq [MHz]	Z _s [Ω]	Z _l [Ω]	Gain [dB]	P _{OUT} [dBm]	P _{OUT} [W]	PAE [%]	Z _l [Ω]	Gain [dB]	P _{OUT} [dBm]	P _{OUT} [W]	PAE [%]
2110	2.1 - 6.1	7.15 - 7.2	19.4	42.06	16.07	59.5	4.8 - 4	21	40.81	12.05	66.8
2140	2.1 - 6.5	6.54 - 7.6	19.2	42.05	16.03	59.3	5.14 - 4.4	21	40.92	12.36	65.8
2170	2.1 - 6.6	7.2 - 7.9	19.3	41.93	15.6	58.2	5.2 - 4.8	21	40.84	12.13	64.6

Reference Circuit, 2100 MHz

DUT	PTFC270101M V1
Reference Circuit No.	LTN/PTFC270101M V1
Order Code	LTNPTFC270101MV1TOBO1
PCB	Rogers RO4350, 0.508 mm [.020"] thick, 2 oz. copper, $\epsilon_r = 3.66$

Find Gerber files for this reference fixture on the Wolfspeed Web site at www.wolfspeed.com/RF

Reference Circuit, 2100 MHz (cont.)

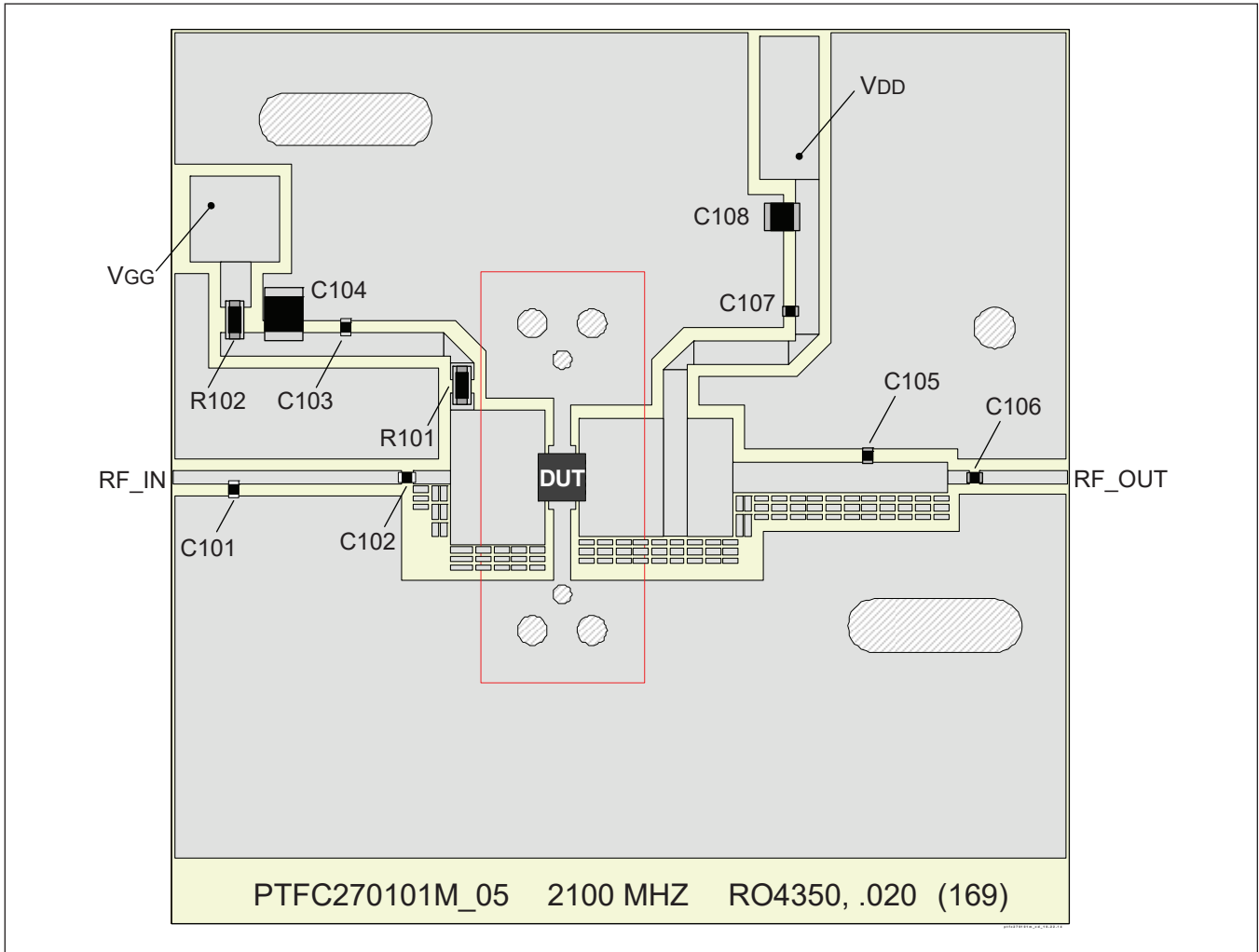

Assembly diagram for reference circuit LTN/PTFC270101M V1, 2100 MHz (not to scale)

Components Information

Component	Description	Manufacturer	P/N
C101	Capacitor, 1.5 pF	ATC	ATC600F1R5CW250
C102, C103, C106, C107	Capacitor, 12 pF	ATC	ATC600F120JW250
C104	Capacitor, 1.0 μ F	TDK Corporation	C4532X7R2A105M230KA
C105	Capacitor, 1.2 pF	ATC	ATC600F1R2CW250
C108	Capacitor, 10 μ F	Taiyo Yuden	UMK325C7106MM-T
R101, R102	Resistor, 10 ohms	Panasonic Electronic Components	ERJ-8GEYJ100V

RF Characteristics

Two-carrier WCDMA Characteristics (not subject to production test)

$V_{DD} = 28\text{ V}$, $I_{DQ} = 120\text{ mA}$, $P_{OUT} = 1.3\text{ W avg}$, $f_1 = 947.5\text{ MHz}$, $f_2 = 957.5\text{ MHz}$,
3GPP WCDMA signal, 3.84 MHz channel bandwidth, 8 dB peak/average @ 0.01% CCDF

Characteristic	Symbol	Min	Typ	Max	Unit
Gain	G_{ps}	—	23	—	dB
Drain Efficiency	η_D	—	20	—	%
Intermodulation Distortion	IMD	—	-39	—	dBc

Typical RF Performance, 920 – 960 MHz (data taken in production test fixture)

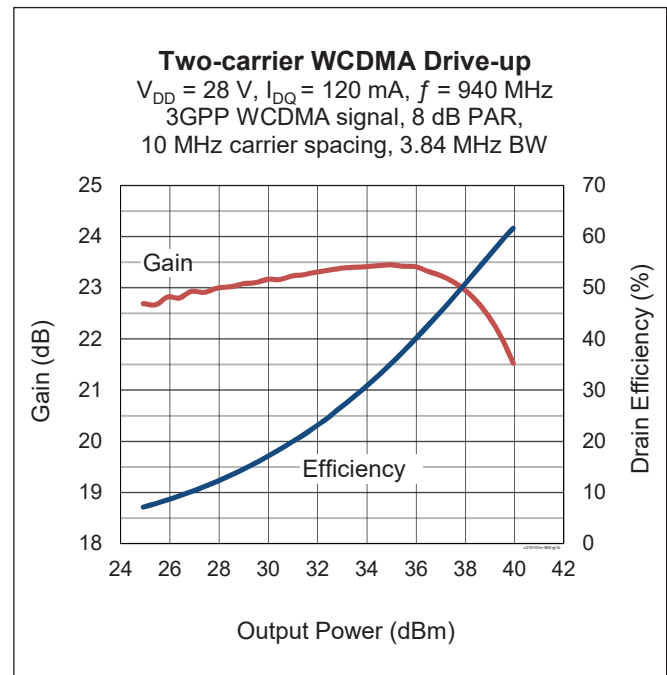
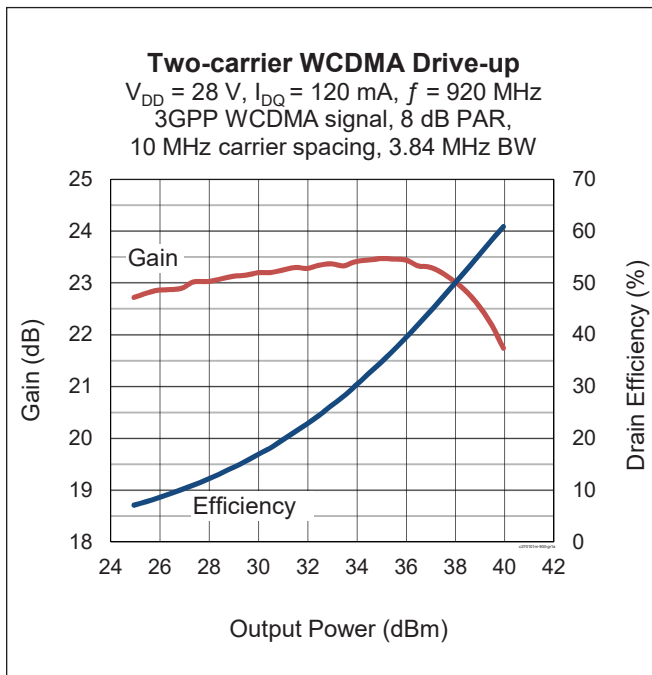

Typical RF Performance, 920 – 960 MHz (cont.)

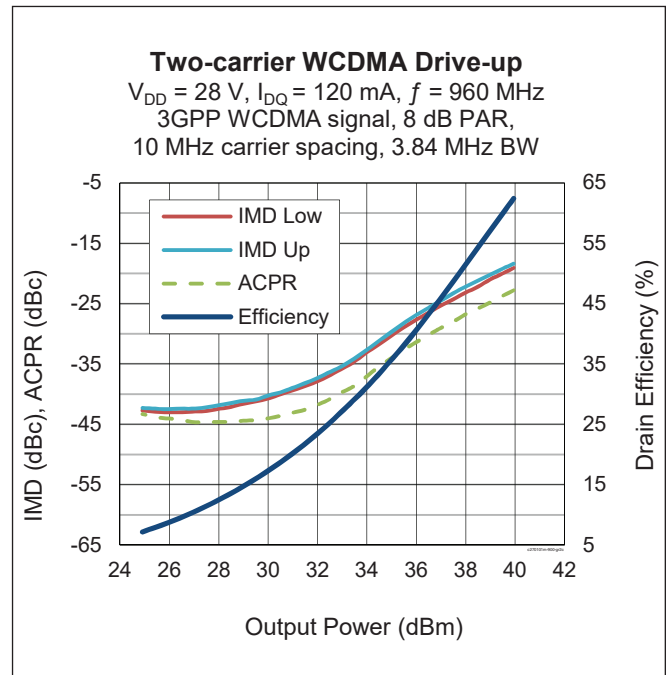
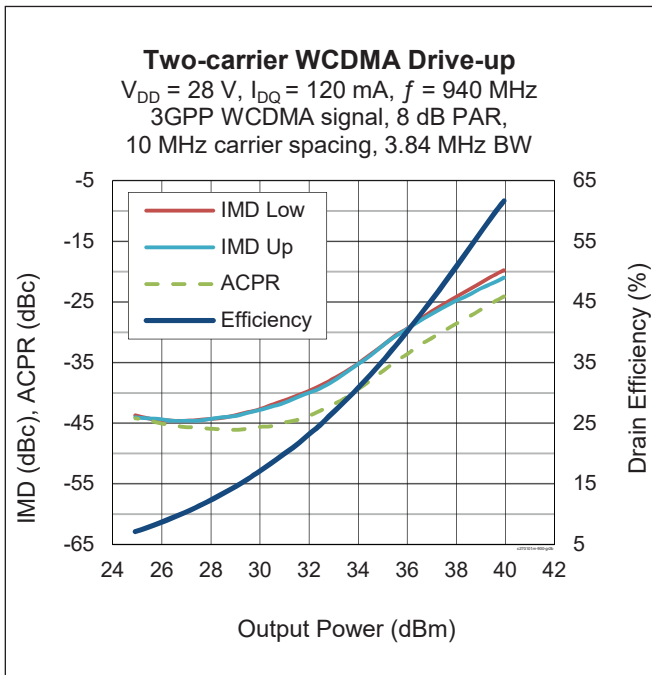
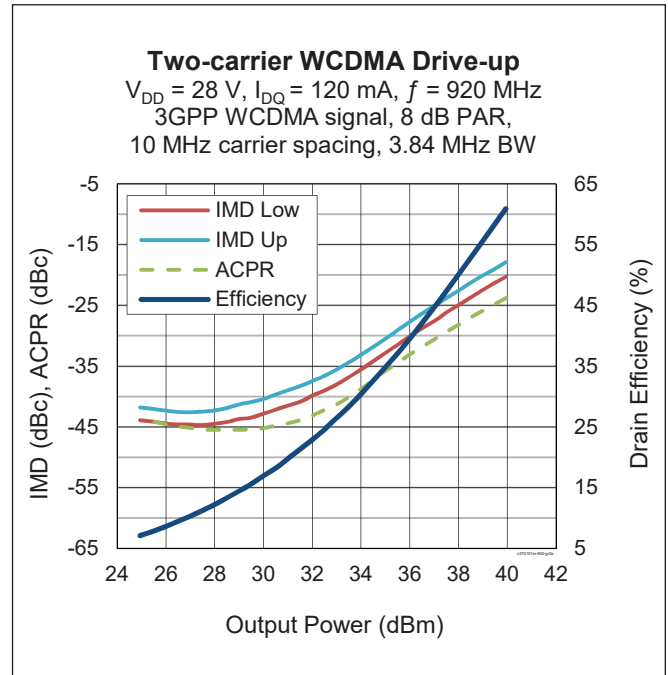
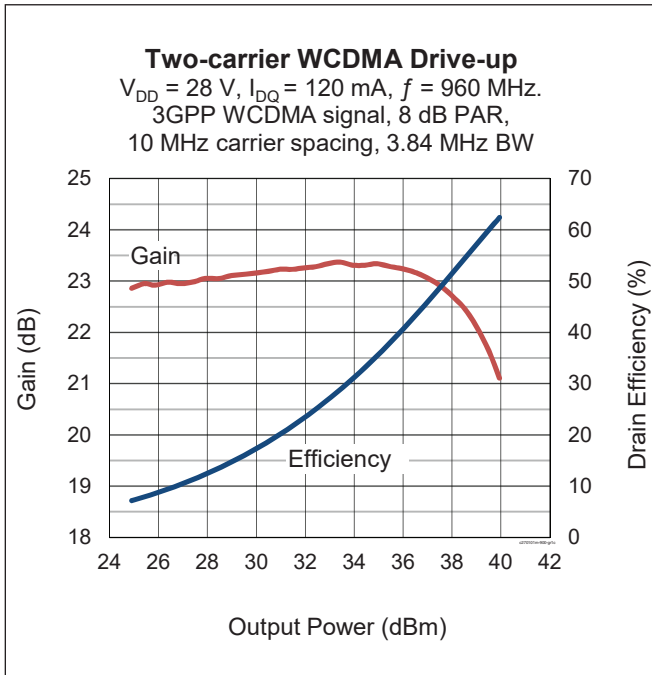

Typical RF Performance, 920 – 960 MHz (cont.)

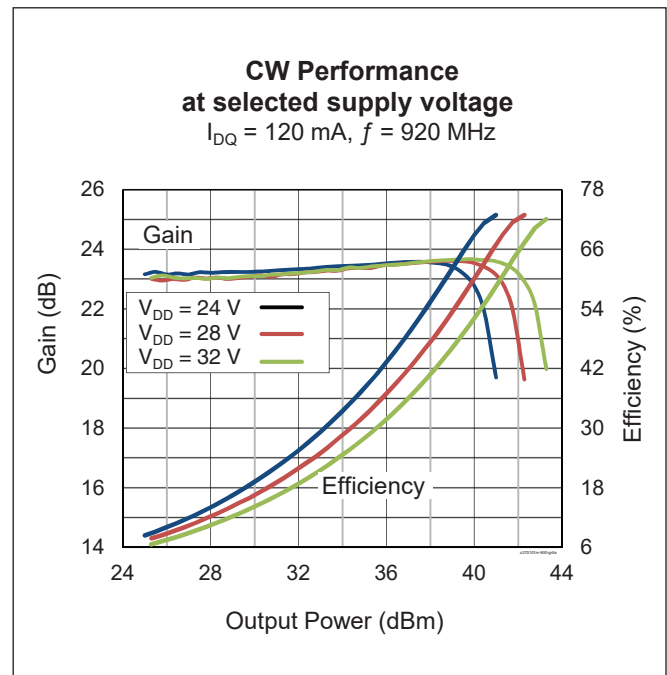
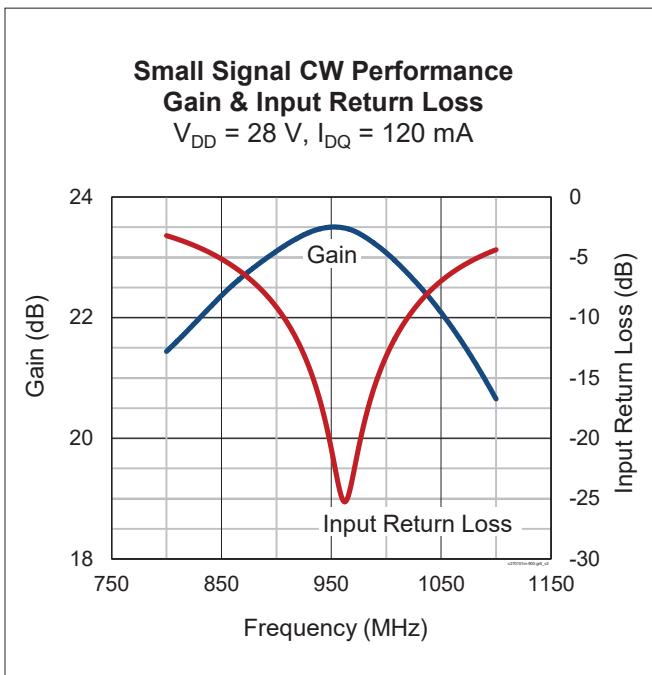
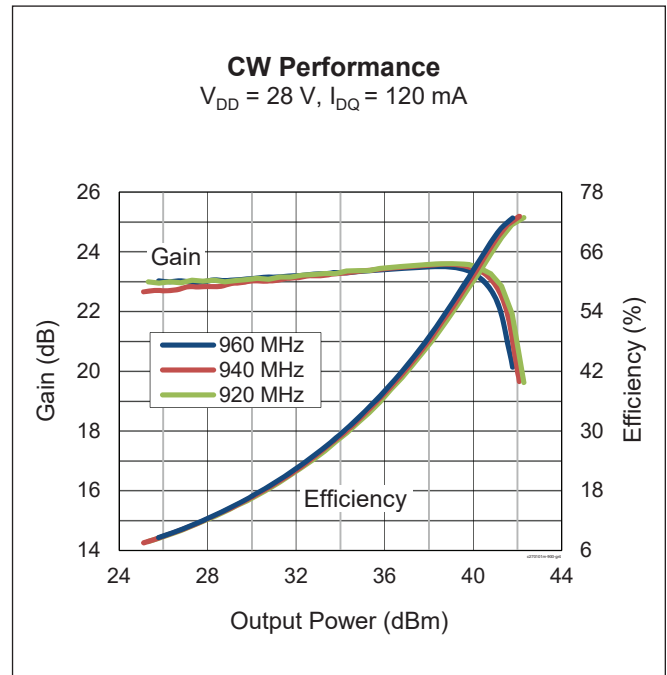
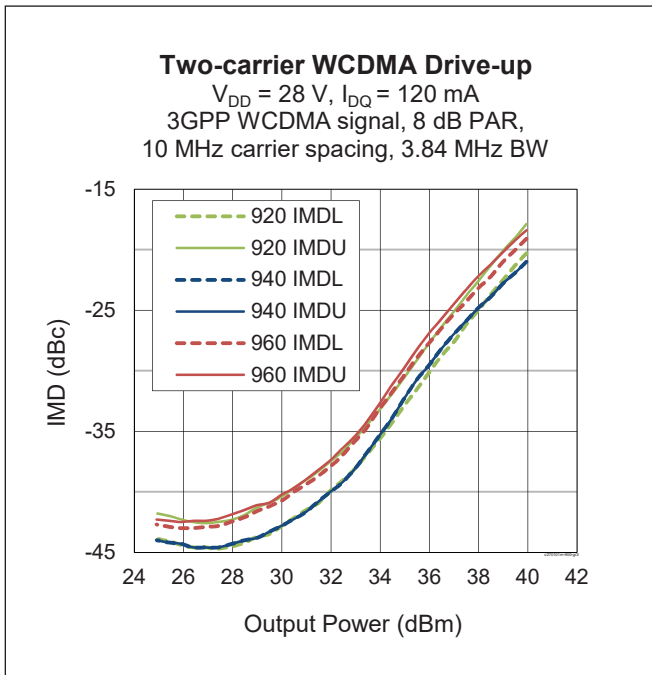

Typical RF Performance, 920 – 960 MHz (cont.)

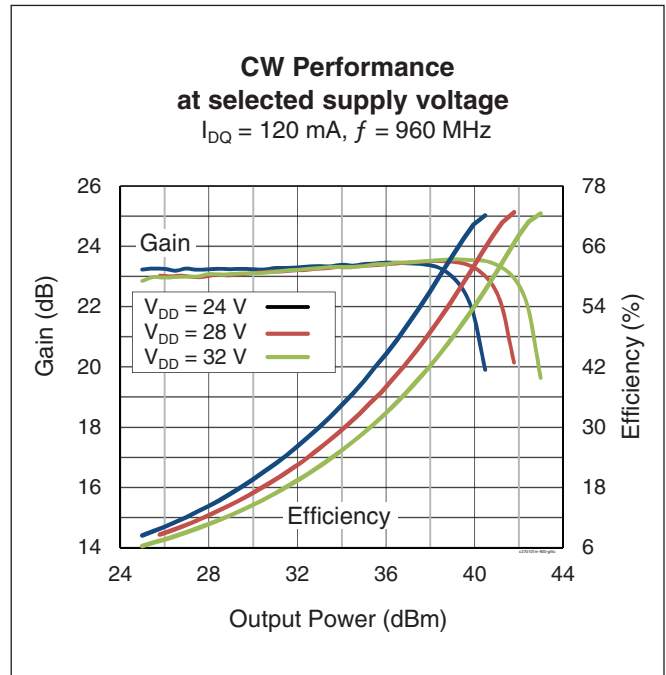
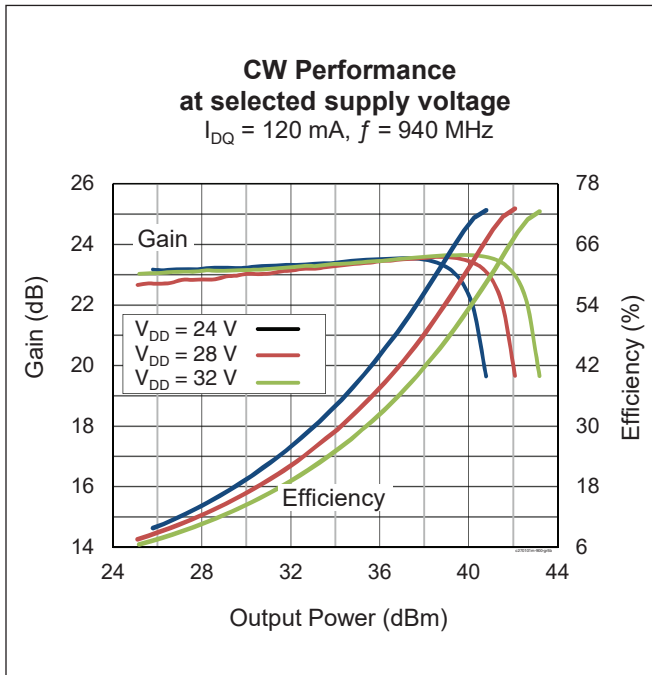

Broadband Circuit Impedance

Freq [MHz]	Z Source Ω		Z Load Ω	
	R	jX	R	jX
920	2.5	3.8	16.3	3.0
940	2.5	4.0	16.3	3.2
960	2.5	4.3	16.3	3.4

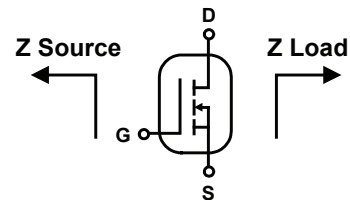

Load Pull Performance

Pulsed CW signal: 160 μ sec, 10% duty cycle; 28 V, 120 mA

Class AB		P _{1dB}									
		Max Output Power					Max PAE				
Freq [MHz]	Z _s [Ω]	Z _l [Ω]	Gain [dB]	P _{OUT} [dBm]	P _{OUT} [W]	PAE [%]	Z _l [Ω]	Gain [dB]	P _{OUT} [dBm]	P _{OUT} [W]	PAE [%]
920	2.02 + j3.96	13.8 - j1.0	24.0	42.3	16.98	62.3	15.7 + j8.1	26.0	40.7	11.75	70.1
940	2.78 + j4.60	15.2 - j2.1	23.7	42.1	16.22	60.5	17.5 + j8.4	25.7	40.3	10.72	67.8
960	2.22 + j3.69	16.1 - j3.3	23.4	42.2	16.6	57.7	16.5 + j8.1	25.7	40.3	10.72	65.8

Reference Circuit, 900 MHz

DUT	PTFC270101M V1
Reference Circuit No.	LTN/PTFC270101M E4
Order Code	LTNPTFC270101ME4TOBO1
PCB	Rogers RO4350, 0.508 mm [.020"] thick, 2 oz. copper, $\epsilon_r = 3.66$
Find Gerber files for this reference fixture on the Wolfspeed Web site at www.wolfspeed.com/RF	

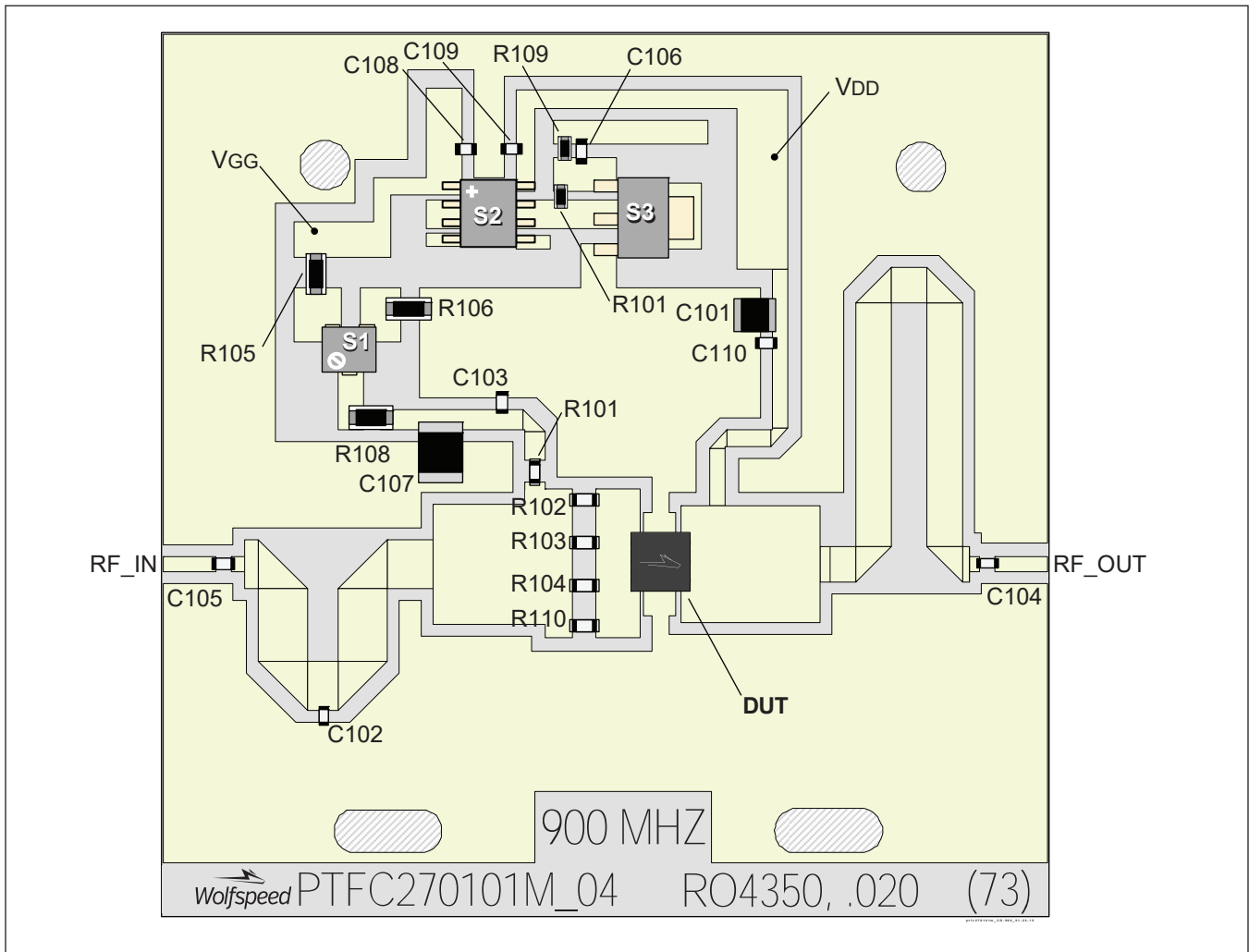

Assembly diagram for reference circuit LTN/PTFC270101M E4, 900 MHz (not to scale)

Reference Circuit, 900 MHz (cont.)**Components Information**

Component	Description	Manufacturer	P/N
C101	Capacitor, 10 μ F	Taiyo Yuden	UMK325C7106MM-T
C102	Capacitor, 5.6 pF	ATC	ATC600F5R6JW250
C103, C104 C105, C110	Capacitor, 56 pF	ATC	ATC100A560JW250
C106, C108, C109	Capacitor, .001 μ F	Panasonic	ECJ-1VB1H102K
C107	Capacitor, 2.2 μ F	TDK Corporation	C3225X7R1H225K250AB
R101, R102, R103, R104, R110	Resistor, 10 ohms	Panasonic – ECG	ERJ-3GEYJ100V
R105, R108	Resistor, 10 ohms	Panasonic Electronic Components	ERJ-8GEYJ100V
R106	Resistor, 1.1K ohms	Panasonic Electronic Components	ERJ-8GEYJ112V
R107	Resistor, 1.2K ohms	Panasonic Electronic Components	ERJ-3GEYJ122V
R109	Resistor, 1.3K ohms	Panasonic Electronic Components	ERJ-3GEYJ132V
S1	Potentiometer, 2k ohms	Bourns Inc.	3224W-1-202E
S2	Voltage Regulator	Texas Instruments	LM78L05ACM
S3	Transistor	Infineon Technologies	BCP56-10

See next page for 2600 MHz operation

RF Characteristics

Two-carrier WCDMA Characteristics (not subject to production test)

$V_{DD} = 28\text{ V}$, $I_{DQ} = 120\text{ mA}$, $P_{OUT} = 1.3\text{ W avg}$, $f_1 = 2650\text{ MHz}$, $f_2 = 2660\text{ MHz}$,
 3GPP WCDMA signal, 3.84 MHz channel bandwidth, 8 dB peak/average @ 0.01% CCDF

Characteristic	Symbol	Min	Typ	Max	Unit
Gain	G_{ps}	—	18.2	—	dB
Drain Efficiency	η_D	—	19.7	—	%
Intermodulation Distortion	IMD	—	-45	—	dBc

Typical RF Performance, 2620 – 2690 MHz (data taken in production test fixture)

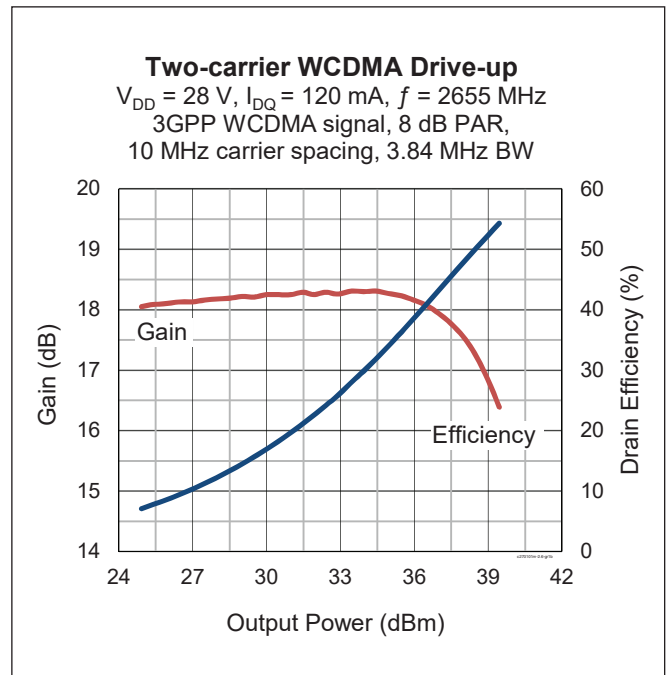
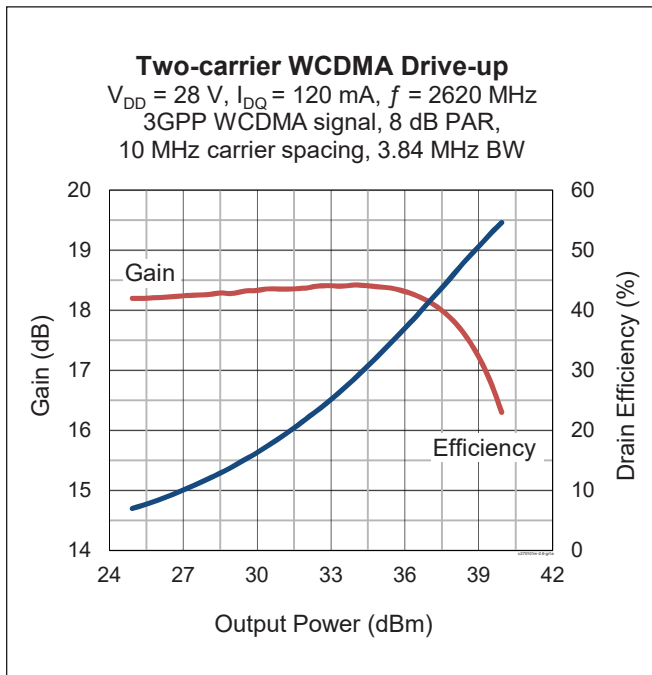

Typical RF Performance, 2620 – 2690 MHz (cont.)

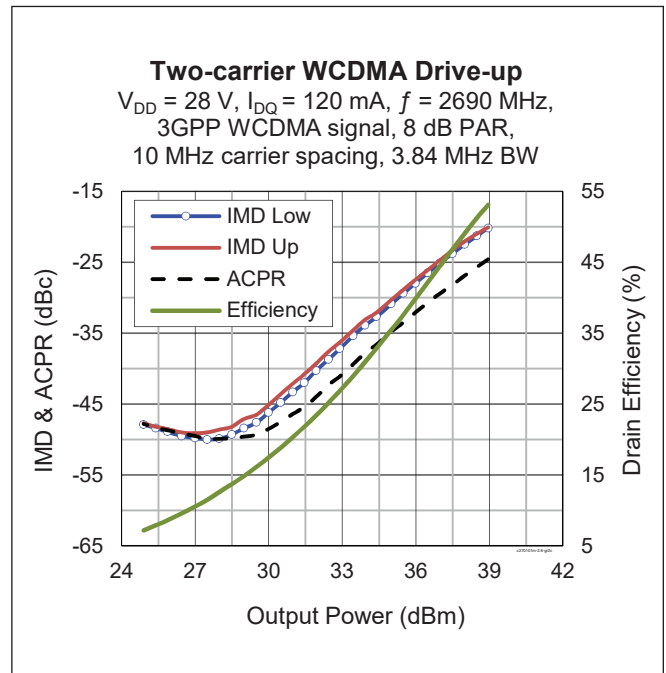
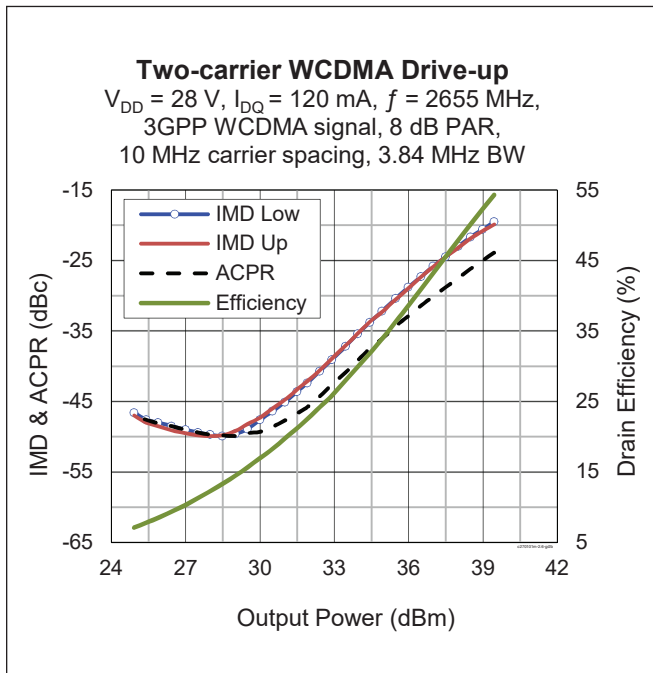
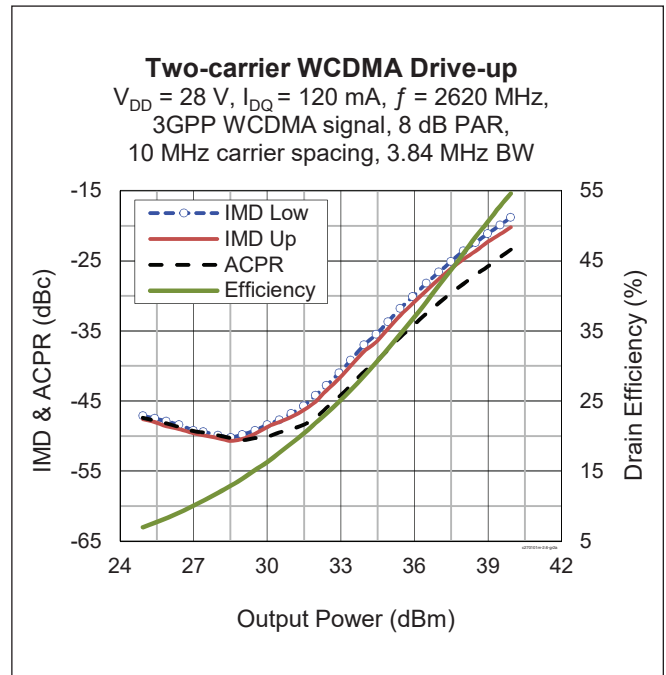
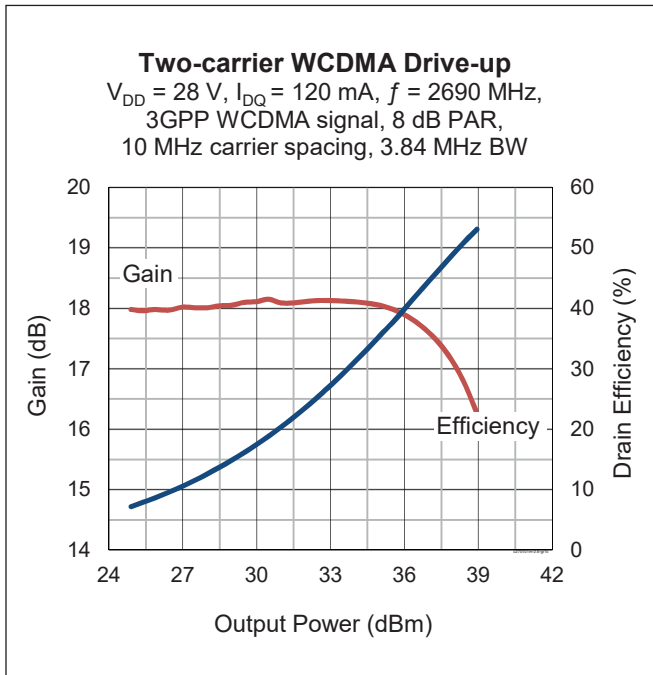

Typical RF Performance, 2620 – 2690 MHz (cont.)

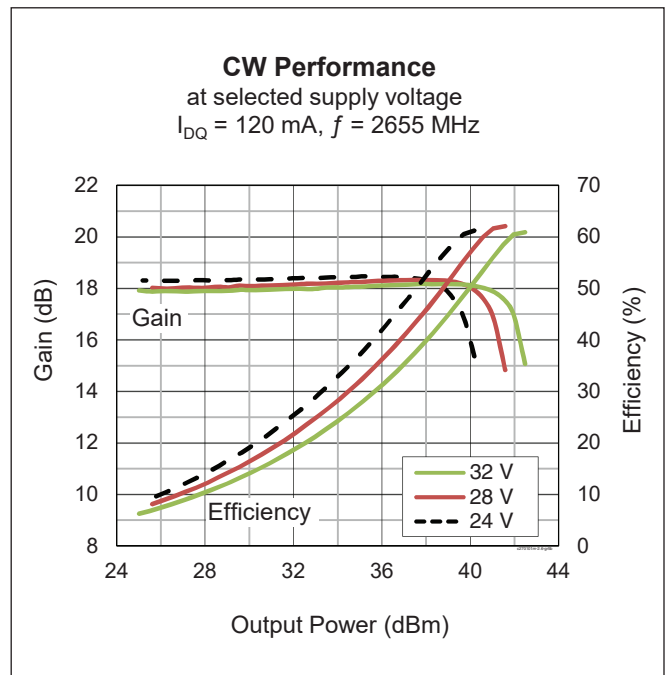
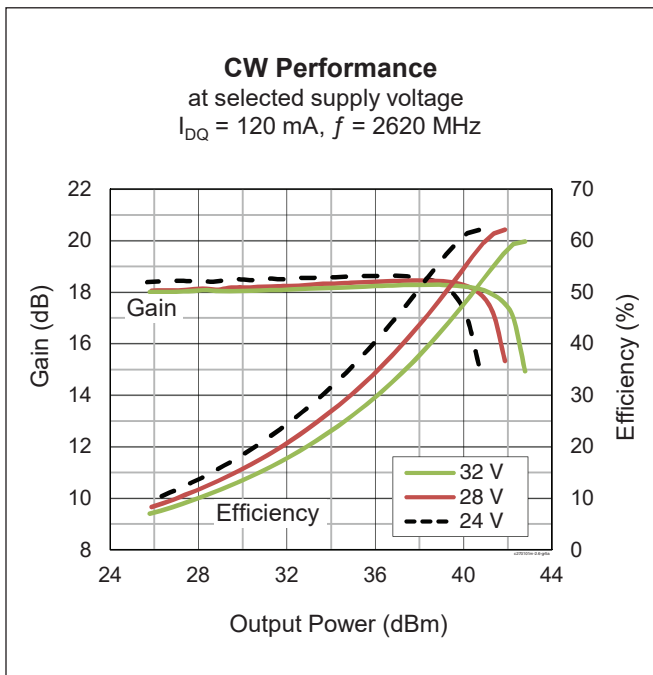
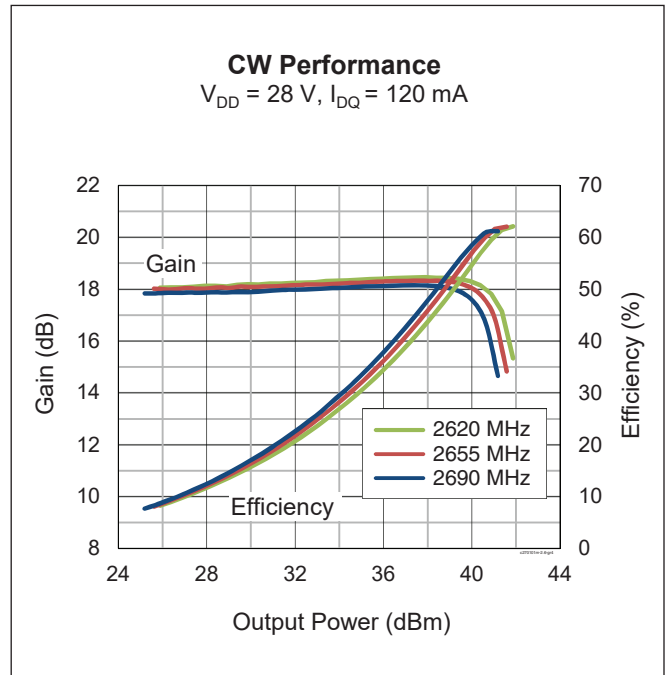
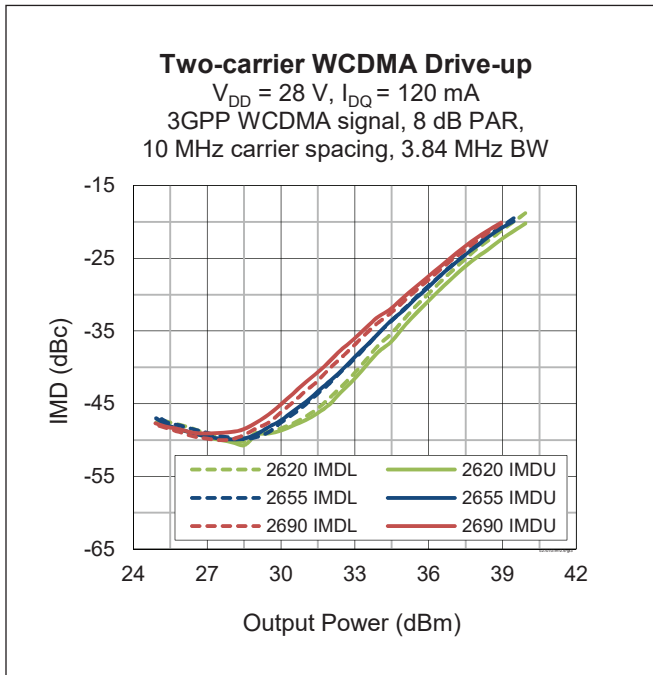

Typical RF Performance, 2620 – 2690 MHz (cont.)

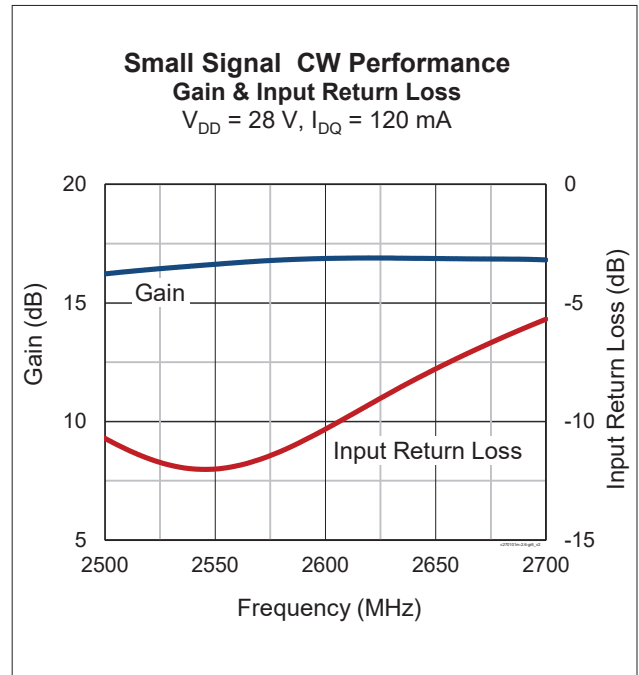
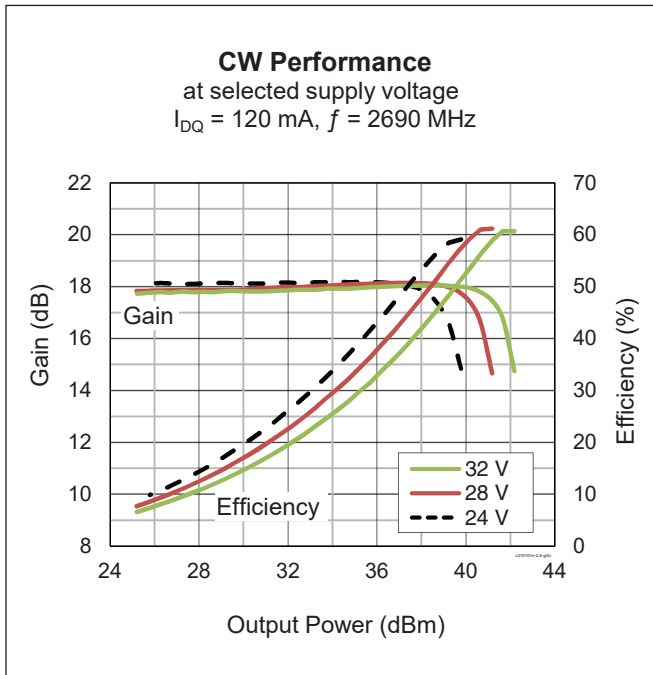

Broadband Circuit Impedance

Freq [MHz]	Z Source Ω		Z Load Ω	
	R	jX	R	jX
2620	2.2	-8.4	5.0	-12.4
2655	2.2	-8.2	5.0	-12.1
2690	2.2	-8.0	5.0	-11.8

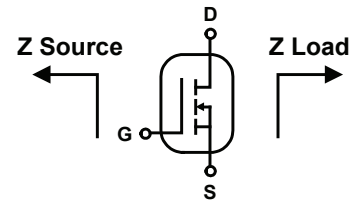

Load Pull Performance

Pulsed CW signal: 160 μsec , 10% duty cycle; 28 V, 120 mA

Class AB		P_{1dB}									
		Max Output Power					Max PAE				
Freq [MHz]	Zs [Ω]	Zl [Ω]	Gain [dB]	POUT [dBm]	POUT [W]	PAE [%]	Zl [Ω]	Gain [dB]	POUT [dBm]	POUT [W]	PAE [%]
2620	2.1 - j7.9	6.35 - j13	17.6	41.48	14.06	55.6	4.35 - j10.8	19.2	40.5	11.22	61.68
2655	2.2 - j8.2	5.93 - j13.2	17.4	41.46	14	54.7	4 - j11	19.1	40.43	11.04	60.8
2690	2.3 - j8.1	5.04 - j13.6	16.5	41.4	13.8	54.5	3.54 - j11.5	18.71	40.21	10.5	61.23

Reference Circuit, 2620 – 2690 MHz

DUT	PTFC270101M V1
Reference Circuit No.	LTN/PTFC270101M E3
Order Code	LTNPTFC270101ME3TOBO1
PCB	Rogers RO4350, 0.508 mm [.020"] thick, 2 oz. copper, $\epsilon_r = 3.66$
Find Gerber files for this reference fixture on the Wolfspeed Web site at www.wolfspeed.com/RF	

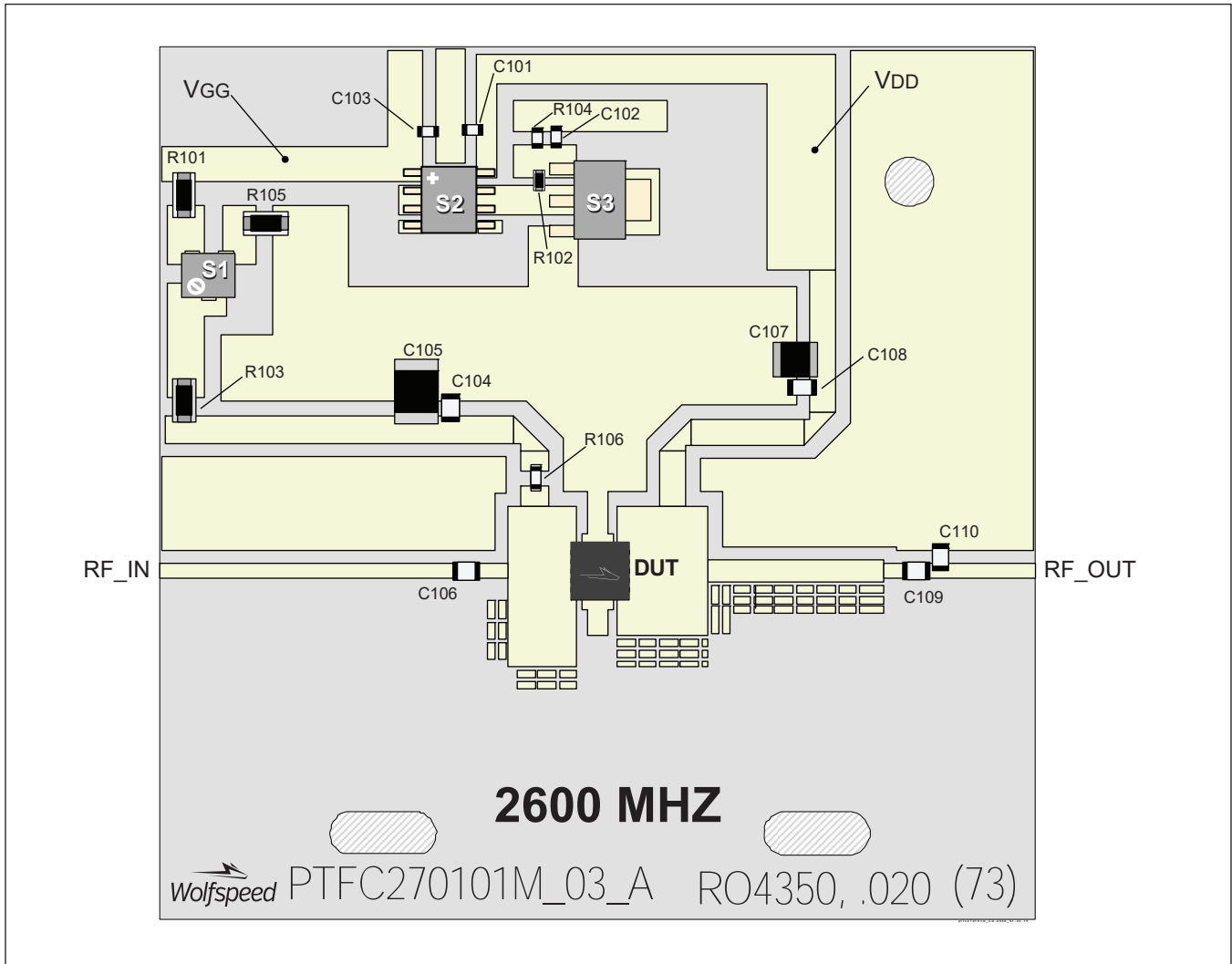

Assembly diagram for reference circuit LTN/PTFC270101M E3, 2600 MHz (not to scale)

Reference Circuit, 2620 – 2690 MHz (cont.)**Components Information**

Component	Description	Manufacturer	P/N
C101, C102, C103	Capacitor, 0.001 μ F	Panasonic	ECJ-1VB1H102K
C104, C108, C109	Capacitor, 12 pF	ATC	ATC600S120JW250
C105	Capacitor, 2.2 μ F	TDK Corporation	C3225X7R1H225K250AB
C106	Capacitor, 1 pF	ATC	ATC600S1R0CW250
C107	Capacitor, 10 μ F	Taiyo Yuden	UMK325C7106MM-T
C110	Capacitor, 0.3 pF	ATC	ATC600S0R3CW250
R101, R103	Resistor, 10 ohms	Panasonic Electronic Components	ERJ-8GEYJ100V
R102	Resistor, 1.2K ohms	Panasonic Electronic Components	ERJ-3GEYJ122V
R104	Resistor, 1.3K ohms	Panasonic Electronic Components	ERJ-3GEYJ132V
R105	Resistor, 470 ohms	Panasonic Electronic Components	ERJ-8GEYJ471V
R106	Resistor, 10 ohms	Panasonic Electronic Components	ERJ-3GEYJ100V
S1	Potentiometer, 2k ohms	Bourns Inc.	3224W-1-202E
S2	Voltage Regulator	Texas Instruments	LM78L05ACM
S3	Transistor	Infineon Technologies	BCP56-10

Package Outline Specifications

