



## Features

- Carbon element
- Red, orange, green, amber and white LED colors
- Center detent option
- Assortment of resistance tapers
- Various travel lengths
- Various lever sizes



# PTL Series Slide Potentiometer w/LED

## Electrical Characteristics

Standard Resistance Range  
 .....1K ohms to 1 megohm  
 Standard Resistance Tolerance.....±20 %  
 End Resistance  
 20 mm Travel ..... 10 ohms max.  
 30 mm Travel ..... 20 ohms max.  
 45 mm Travel ..... 20 ohms max.  
 60 mm Travel ..... 30 ohms max.  
 100 mm Travel ..... 30 ohms max.  
 Insulation Resistance @ 250 VDC  
 ..... 100 megohms min.  
 Dielectric Withstanding Voltage  
 .....300 VAC  
 Standard Taper ..... Linear, Audio  
 Power Rating - Linear  
 20 mm Travel ..... 0.05 watt  
 30 mm Travel ..... 0.1 watt  
 45 mm Travel ..... 0.125 watt  
 60 mm Travel ..... 0.2 watt  
 100 mm Travel ..... 0.2 watt  
 Power Rating - Audio  
 20 mm Travel ..... 0.025 watt  
 30 mm Travel ..... 0.05 watt  
 45 mm Travel ..... 0.06 watt  
 60 mm Travel ..... 0.1 watt  
 100 mm Travel ..... 0.1 watt  
 Slider Noise .....200 mV max.

## Environmental Characteristics

Operational Life ..... 15,000 cycles  
 TR Shift .....±15 %  
 Operating Temperature Range  
 .....-10 °C to +55 °C  
 Resistance to Solder Heat.....±5 %  
 Moisture Sensitivity Level ..... 1  
 ESD Classification (HBM)..... N/A

## Mechanical Characteristics

Mechanical Travel..... Length ±0.5 mm  
 Operating Force.....30 gf to 250 gf  
 Center Detent Force .....20 gf to 200 gf  
 Stop Strength..... 5 kgf min.  
 Shaft Axial Force ..... 5 kgf min.  
 Shaft Wobble ...2(2 x L/20) mm p-p max.  
 Soldering Condition  
 Manual ..... 300 °C ±5 °C for 3 sec.  
 Wave ..... 260 °C ±5 °C for 5 sec.  
 Wash ..... Not recommended

## Product Dimensions

### 20 mm Length of Travel

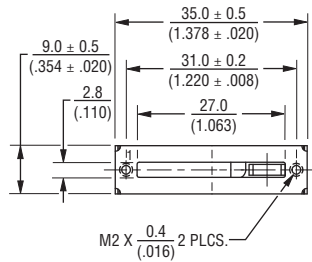

Lever Length
10.0 (.394)
15.0 (.591)
19.0 (.748)



DIMENSIONS:  $\frac{\text{MM}}{\text{(INCHES)}}$

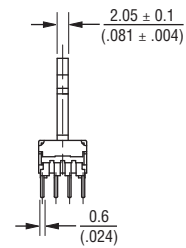

### Mounting Hole Detail

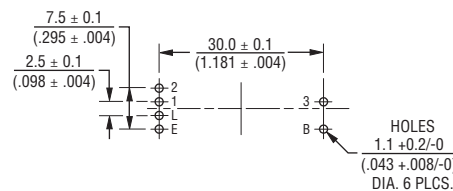

## Standard Resistance Table

Resistance (Ohms)	Resistance Code
1,000	102
2,000	202
5,000	502
10,000	103
20,000	203
50,000	503
100,000	104
200,000	204
500,000	504
1,000,000	105

## Schematic

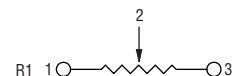

**WARNING** Cancer and Reproductive Harm - [www.P65Warnings.ca.gov](http://www.P65Warnings.ca.gov)

\*RoHS Directive 2015/863, Mar 31, 2015 and Annex.  
 Specifications are subject to change without notice.

Users should verify actual device performance in their specific applications.

The products described herein and this document are subject to specific legal disclaimers as set forth on the last page of this document, and at [www.bourns.com/docs/legal/disclaimer.pdf](http://www.bourns.com/docs/legal/disclaimer.pdf).

## Applications

- Mixing consoles
- Drum machines
- Keyboards and synthesizers
- Equalizers

# PTL Series Slide Potentiometer w/LED

**BOURNS®**

## Product Dimensions

### 30 mm Length of Travel



### Mounting Hole Detail



### 45 mm Length of Travel

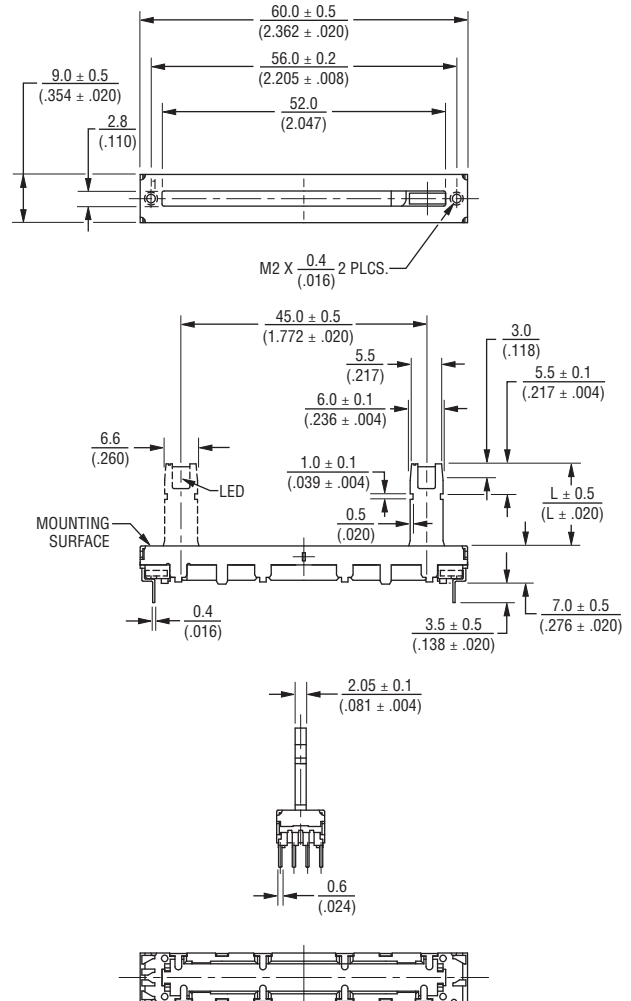

### Mounting Hole Detail

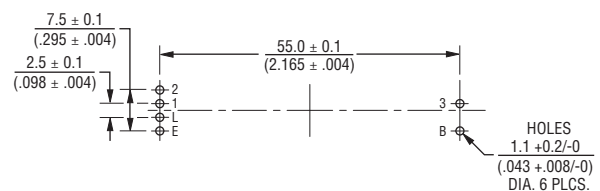

Specifications are subject to change without notice.

Users should verify actual device performance in their specific applications.

The products described herein and this document are subject to specific legal disclaimers as set forth on the last page of this document, and at [www.bourns.com/docs/legal/disclaimer.pdf](http://www.bourns.com/docs/legal/disclaimer.pdf).

# PTL Series Slide Potentiometer w/LED

**BOURNS®**

## Product Dimensions

### 60 mm Length of Travel

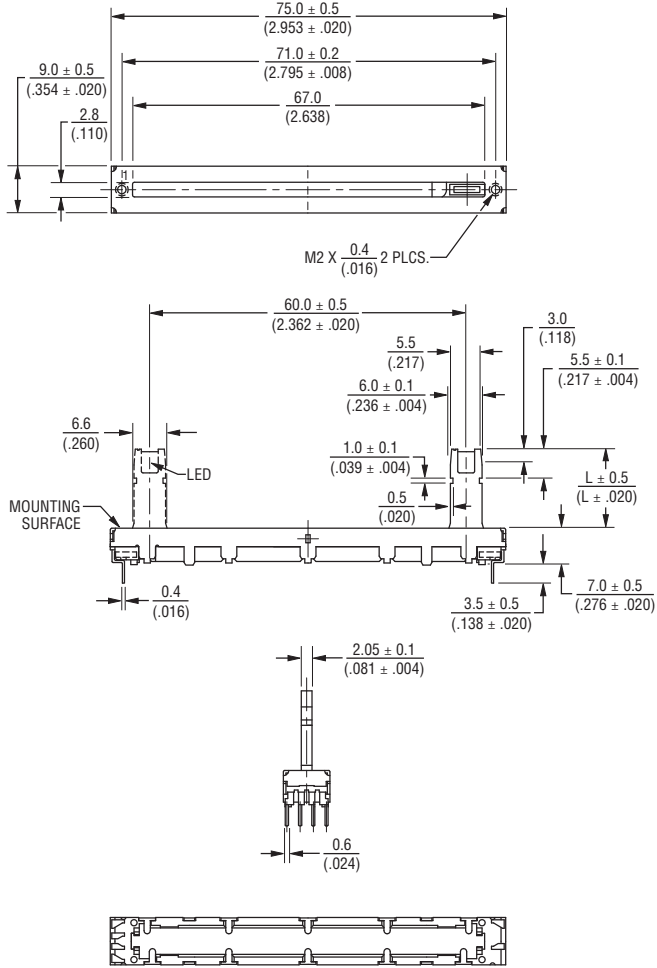

### Mounting Hole Detail



DIMENSIONS:  $\frac{MM}{(INCHES)}$

### 100 mm Length of Travel

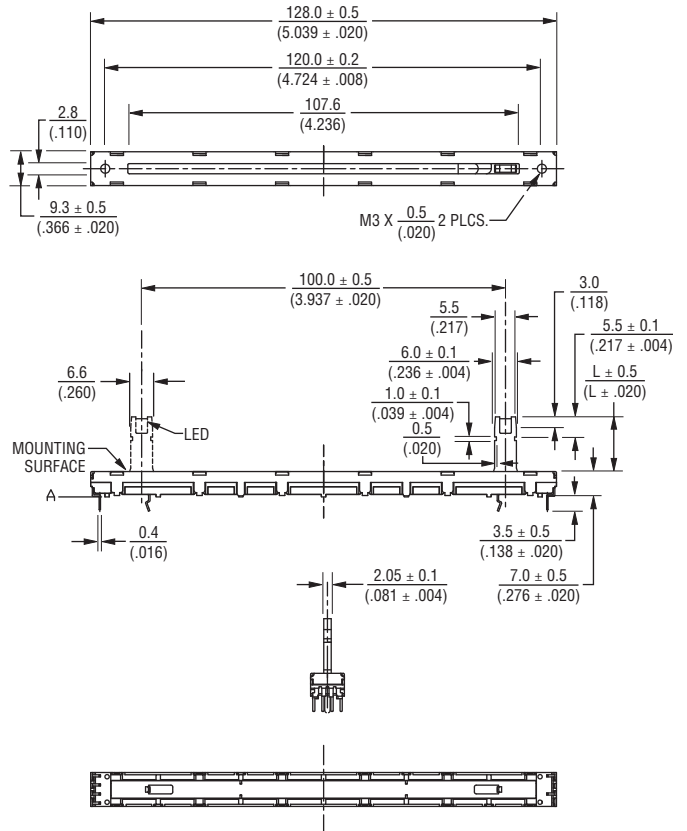

### Mounting Hole Detail



Specifications are subject to change without notice.  
 Users should verify actual device performance in their specific applications.  
 The products described herein and this document are subject to specific legal disclaimers as set forth on the last page of this document, and at [www.bourns.com/docs/legal/disclaimer.pdf](http://www.bourns.com/docs/legal/disclaimer.pdf).

# PTL Series Slide Potentiometer w/LED

**BOURNS®**

## Tapers



## Circuit



## How To Order

**PTL 30 - 10 R 0 - 103 B2**

Model Number \_\_\_\_\_  
 Designator \_\_\_\_\_  
 PTL = Slide Potentiometer w/LED  
 Length of Travel \_\_\_\_\_  
 20 = 20 mm    45 = 45 mm    01 = 100 mm  
 30 = 30 mm    60 = 60 mm  
 Lever Length \_\_\_\_\_  
 10 = 10 mm  
 15 = 15 mm  
 19 = 19 mm  
 LED Color \_\_\_\_\_  
 R = Red    A = Amber  
 O = Orange    W = White  
 G = Green  
 Detent Option \_\_\_\_\_  
 0 = No Detent  
 1 = Center Detent  
 Resistance Code \_\_\_\_\_  
 (See Standard Resistance Table)  
 Resistance Taper (See Taper Charts) \_\_\_\_\_  
 Taper Series followed by Curve Number

# PTL Series Slide Potentiometer w/LED

**BOURNS®**

## LED Characteristics

Emitter Color	Item	Symbol	Test Conditions	Min.	Typ.	Max.	Unit
Red	Forward Voltage	$V_F$	$I_F = 20 \text{ mA}$		1.8	2.0	V
	Luminous Intensity	$I_V$		12	20		mcd
	Peak Emission Wavelength	$\lambda_p$			660		nm
	Dominant Wavelength	$\lambda_d$			643		nm
	Spectral Line Half Width	$\Delta\lambda$			20		nm
Orange	Forward Voltage	$V_F$	$I_F = 20 \text{ mA}$		2.0	2.7	V
	Luminous Intensity	$I_V$		9	15		mcd
	Peak Emission Wavelength	$\lambda_p$			610		nm
	Dominant Wavelength	$\lambda_d$			605		nm
	Spectral Line Half Width	$\Delta\lambda$			35		nm
Green	Forward Voltage	$V_F$	$I_F = 20 \text{ mA}$		3.3	4.0	V
	Luminous Intensity	$I_V$		105	175		mcd
	Peak Emission Wavelength	$\lambda_p$			530		nm
	Dominant Wavelength	$\lambda_d$			35		nm
	Spectral Line Half Width	$\Delta\lambda$			160		nm
Amber	Forward Voltage	$V_F$	$I_F = 20 \text{ mA}$		2.1	2.6	V
	Luminous Intensity	$I_V$			5.0		mcd
	Peak Emission Wavelength	$\lambda_p$			585		nm
	Dominant Wavelength	$\lambda_d$		582	–	595	nm
	Spectral Line Half Width	$\Delta\lambda$			35		nm
White	Forward Voltage	$V_F$	$I_F = 20 \text{ mA}$		3.2	3.6	V
	Luminous Intensity	$I_V$			1000		mcd
	Peak Emission Wavelength	$\lambda_p$			–		nm
	Dominant Wavelength	$\lambda_d$		460	–	470	nm
	Spectral Line Half Width	$\Delta\lambda$			35		nm

**BOURNS®**

Asia-Pacific: Tel: +886-2 2562-4117 • Email: asiacus@bourns.com

EMEA: Tel: +36 88 885 877 • Email: eurocus@bourns.com

The Americas: Tel: +1-951 781-5500 • Email: americus@bourns.com

[www.bourns.com](http://www.bourns.com)

REV. 10/19

Specifications are subject to change without notice.

Users should verify actual device performance in their specific applications.

The products described herein and this document are subject to specific legal disclaimers as set forth on the last page of this document, and at [www.bourns.com/docs/legal/disclaimer.pdf](http://www.bourns.com/docs/legal/disclaimer.pdf).