



Features

- Carbon element
- Red, orange, green, amber and white LED colors
- Center detent option
- Assortment of resistance tapers
- Various travel lengths
- Various lever sizes



PTL Series Slide Potentiometer w/LED

Electrical Characteristics

Standard Resistance Range1K ohms to 1 megohm
 Standard Resistance Tolerance....±20 %
 End Resistance
 20 mm Travel 10 ohms max.
 30 mm Travel 20 ohms max.
 45 mm Travel 20 ohms max.
 60 mm Travel 30 ohms max.
 100 mm Travel 30 ohms max.
 Insulation Resistance @ 250 VDC
 100 megohms min.
 Dielectric Withstanding Voltage
300 VAC
 Standard Taper Linear, Audio
 Power Rating - Linear
 20 mm Travel 0.05 watt
 30 mm Travel 0.1 watt
 45 mm Travel 0.125 watt
 60 mm Travel 0.2 watt
 100 mm Travel 0.2 watt
 Power Rating - Audio
 20 mm Travel 0.025 watt
 30 mm Travel 0.05 watt
 45 mm Travel 0.06 watt
 60 mm Travel 0.1 watt
 100 mm Travel 0.1 watt
 Slider Noise200 mV max.

Environmental Characteristics

Operational Life 15,000 cycles
 TR Shift±15 %
 Operating Temperature Range
-10 °C to +55 °C
 Resistance to Solder Heat.....±5 %
 Moisture Sensitivity Level 1
 ESD Classification (HBM)..... N/A

Mechanical Characteristics

Mechanical Travel..... Length ±0.5 mm
 Operating Force.....30 gf to 250 gf
 Center Detent Force.....20 gf to 200 gf
 Stop Strength..... 5 kgf min.
 Shaft Axial Force 5 kgf min.
 Shaft Wobble ...2(2 x L/20) mm p-p max.
 Soldering Condition
 Manual 300 °C ±5 °C for 3 sec.
 Wave 260 °C ±5 °C for 5 sec.
 Wash Not recommended

Product Dimensions

20 mm Length of Travel



| Lever Length |
|----------------|
| 10.0 (.394) |
| 15.0 (.591) |
| 19.0 (.748) |

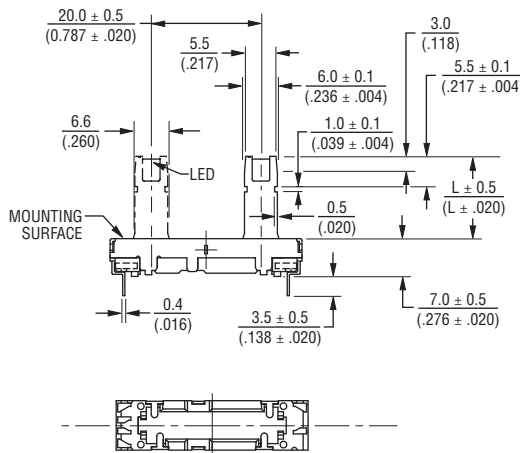

DIMENSIONS: $\frac{\text{MM}}{\text{(INCHES)}}$

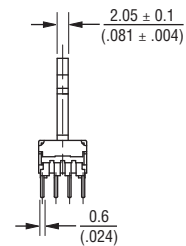

Mounting Hole Detail

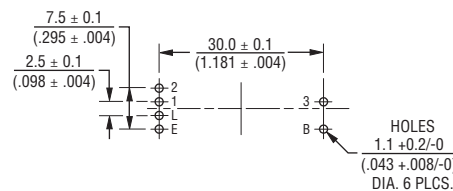

Standard Resistance Table

| Resistance (Ohms) | Resistance Code |
|-------------------|-----------------|
| 1,000 | 102 |
| 2,000 | 202 |
| 5,000 | 502 |
| 10,000 | 103 |
| 20,000 | 203 |
| 50,000 | 503 |
| 100,000 | 104 |
| 200,000 | 204 |
| 500,000 | 504 |
| 1,000,000 | 105 |

Schematic

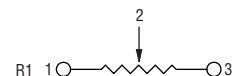

WARNING Cancer and Reproductive Harm - www.P65Warnings.ca.gov

*RoHS Directive 2015/863, Mar 31, 2015 and Annex.
 Specifications are subject to change without notice.

Users should verify actual device performance in their specific applications.

The products described herein and this document are subject to specific legal disclaimers as set forth on the last page of this document, and at www.bourns.com/docs/legal/disclaimer.pdf.

Applications

- Mixing consoles
- Drum machines
- Keyboards and synthesizers
- Equalizers

PTL Series Slide Potentiometer w/LED

BOURNS®

Product Dimensions

30 mm Length of Travel



Mounting Hole Detail



45 mm Length of Travel

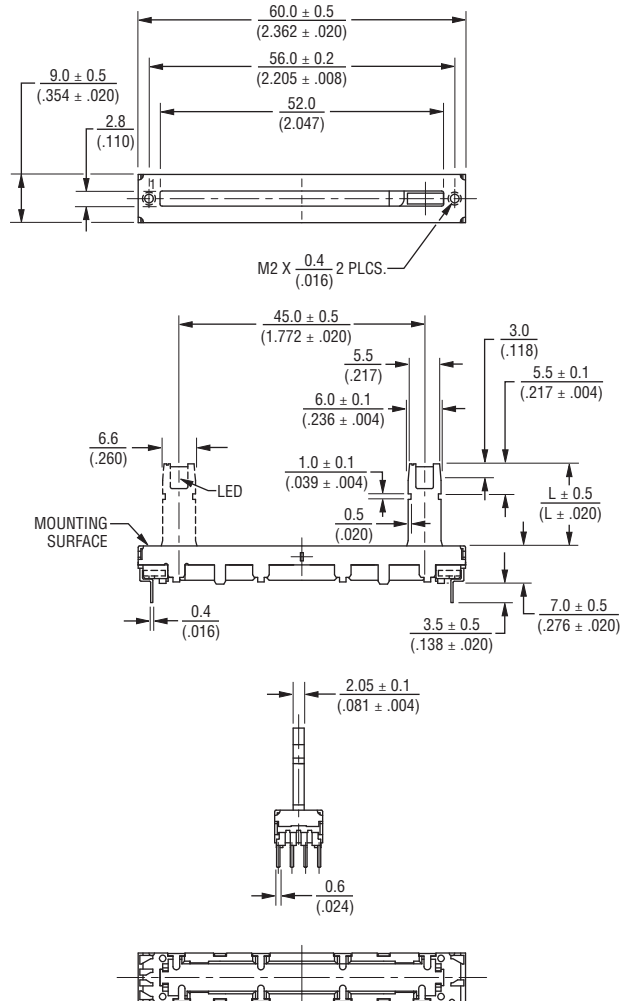

Mounting Hole Detail

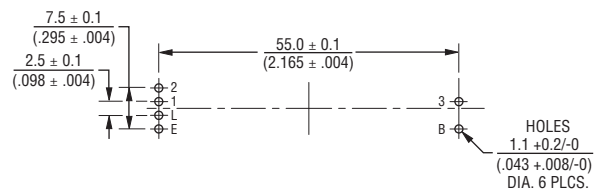

Specifications are subject to change without notice.

Users should verify actual device performance in their specific applications.

The products described herein and this document are subject to specific legal disclaimers as set forth on the last page of this document, and at www.bourns.com/docs/legal/disclaimer.pdf.

PTL Series Slide Potentiometer w/LED

BOURNS®

Product Dimensions

60 mm Length of Travel

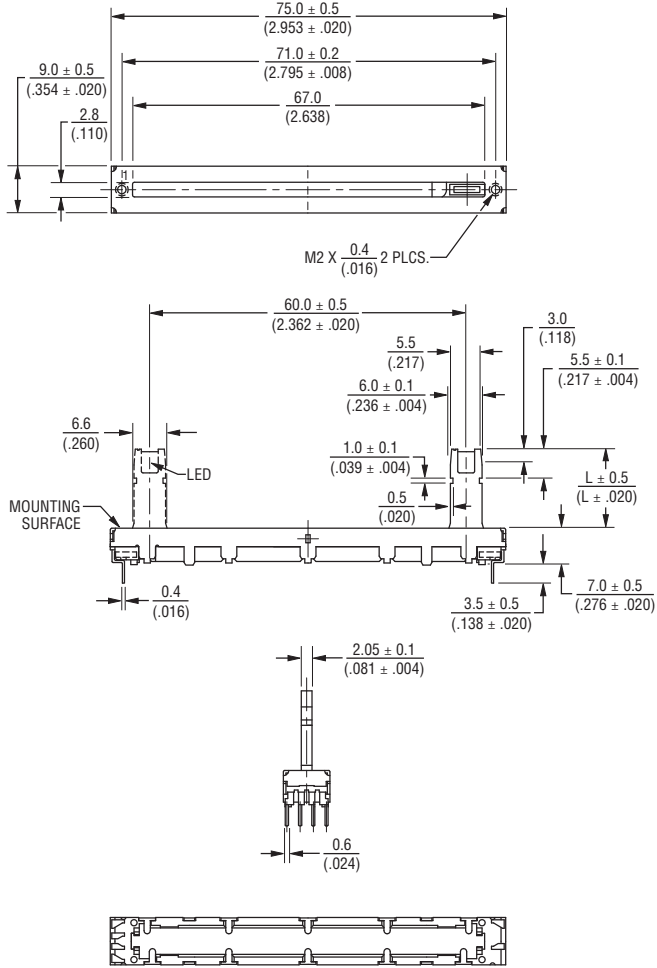

Mounting Hole Detail



DIMENSIONS: $\frac{\text{MM}}{\text{(INCHES)}}$

100 mm Length of Travel

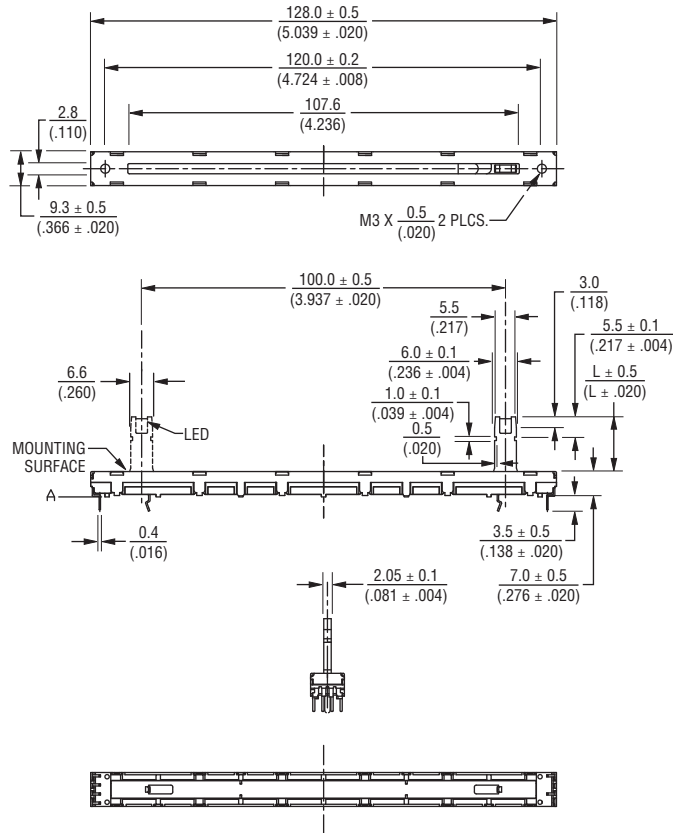

Mounting Hole Detail



Specifications are subject to change without notice.

Users should verify actual device performance in their specific applications.

The products described herein and this document are subject to specific legal disclaimers as set forth on the last page of this document, and at www.bourns.com/docs/legal/disclaimer.pdf.

PTL Series Slide Potentiometer w/LED

BOURNS®

Tapers



Circuit



How To Order

PTL 30 - 10 R 0 - 103 B2

Model Number _____
 Designator _____
 PTL = Slide Potentiometer w/LED
 Length of Travel _____
 20 = 20 mm 45 = 45 mm 01 = 100 mm
 30 = 30 mm 60 = 60 mm
 Lever Length _____
 10 = 10 mm
 15 = 15 mm
 19 = 19 mm
 LED Color _____
 R = Red A = Amber
 O = Orange W = White
 G = Green
 Detent Option _____
 0 = No Detent
 1 = Center Detent
 Resistance Code _____
 (See Standard Resistance Table)
 Resistance Taper (See Taper Charts) _____
 Taper Series followed by Curve Number

PTL Series Slide Potentiometer w/LED

BOURNS®

LED Characteristics

| Emitter Color | Item | Symbol | Test Conditions | Min. | Typ. | Max. | Unit |
|---------------|--------------------------|-----------------|-----------------------|------|------|------|------|
| Red | Forward Voltage | V_F | $I_F = 20 \text{ mA}$ | | 1.8 | 2.0 | V |
| | Luminous Intensity | I_V | | 12 | 20 | | mcd |
| | Peak Emission Wavelength | λ_p | | | 660 | | nm |
| | Dominant Wavelength | λ_d | | | 643 | | nm |
| | Spectral Line Half Width | $\Delta\lambda$ | | | 20 | | nm |
| Orange | Forward Voltage | V_F | $I_F = 20 \text{ mA}$ | | 2.0 | 2.7 | V |
| | Luminous Intensity | I_V | | 9 | 15 | | mcd |
| | Peak Emission Wavelength | λ_p | | | 610 | | nm |
| | Dominant Wavelength | λ_d | | | 605 | | nm |
| | Spectral Line Half Width | $\Delta\lambda$ | | | 35 | | nm |
| Green | Forward Voltage | V_F | $I_F = 20 \text{ mA}$ | | 3.3 | 4.0 | V |
| | Luminous Intensity | I_V | | 105 | 175 | | mcd |
| | Peak Emission Wavelength | λ_p | | | 530 | | nm |
| | Dominant Wavelength | λ_d | | | 35 | | nm |
| | Spectral Line Half Width | $\Delta\lambda$ | | | 160 | | nm |
| Amber | Forward Voltage | V_F | $I_F = 20 \text{ mA}$ | | 2.1 | 2.6 | V |
| | Luminous Intensity | I_V | | | 5.0 | | mcd |
| | Peak Emission Wavelength | λ_p | | | 585 | | nm |
| | Dominant Wavelength | λ_d | | 582 | – | 595 | nm |
| | Spectral Line Half Width | $\Delta\lambda$ | | | 35 | | nm |
| White | Forward Voltage | V_F | $I_F = 20 \text{ mA}$ | | 3.2 | 3.6 | V |
| | Luminous Intensity | I_V | | | 1000 | | mcd |
| | Peak Emission Wavelength | λ_p | | | – | | nm |
| | Dominant Wavelength | λ_d | | 460 | – | 470 | nm |
| | Spectral Line Half Width | $\Delta\lambda$ | | | 35 | | nm |

BOURNS®

Asia-Pacific: Tel: +886-2 2562-4117 • Email: asiacus@bourns.com

EMEA: Tel: +36 88 885 877 • Email: eurocus@bourns.com

The Americas: Tel: +1-951 781-5500 • Email: americus@bourns.com

www.bourns.com

REV. 10/19

Specifications are subject to change without notice.

Users should verify actual device performance in their specific applications.

The products described herein and this document are subject to specific legal disclaimers as set forth on the last page of this document, and at www.bourns.com/docs/legal/disclaimer.pdf.