

# PTR016V

## 16 Volt DC radial leaded, PolyTron™ PTC devices

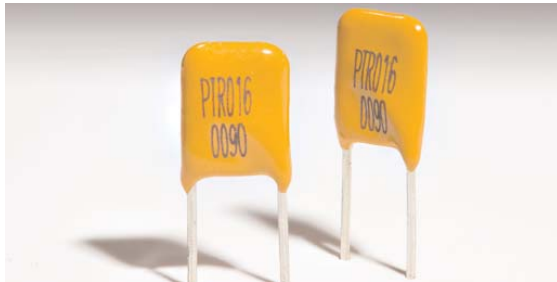

### Product features

- PolyTron™ radial leaded thru-hole PTC device
- Maximum 16 V
- Current ratings from 0.9 A to 15 A
- Fast time-to-trip
- Low resistance
- Halogen free, lead free, RoHS compliant

### Applications

- Medical equipment
- Telecommunications
- White goods
- Computers and peripherals

### Agency information

- cURus: Recognized Card: File E343021 (Ihold 3A-15 A)
- TUV File: J 50194729

### Ordering information/ part number system



**Lead Codes:** TR & BK - Straight Leads, TR1 & BK1 - Kinked Leads

#### TR & TR1 On Reels

- 0.9-1.85 A - 3000 devices
- 2.5-4 A - 2500 devices
- 5-7 A - 1500 devices
- 8-15 A - 1000 devices

#### BK & BK1 In Poly Bags

- 0.9-1.60 A - 1000 devices
- 1.85-9.00 A - 1000 devices
- 10.00-15.00 A - 250 devices

Specifications												
Catalog Number	V <sub>max</sub> (Vdc)	I <sub>max</sub> (A)	I <sub>hold</sub> @ +23 °C (A)	I <sub>trip</sub> @ +23 °C (A)	Pd Typ. (W)	Time to Trip (Max.)		Resistance (Ω)			Agency Information	
						(A)	(sec)	Initial (R <sub>i</sub> )		Post Trip (R <sub>t</sub> )	cURus	TUV
								Min.	Max.			
PTR016V0090	16	40	0.90	1.80	0.60	8.00	1.20	0.070	0.120	0.180		X
PTR016V0110	16	40	1.10	2.20	0.70	8.00	2.30	0.050	0.095	0.140		X
PTR016V0135	16	40	1.35	2.70	0.80	8.00	4.50	0.040	0.074	0.120		X
PTR016V0160	16	40	1.60	3.20	0.90	8.00	9.00	0.030	0.061	0.110		X
PTR016V0185	16	40	1.85	3.70	1.00	8.00	10.00	0.030	0.051	0.090		X
PTR016V0250	16	40	2.50	5.00	1.20	8.00	40.00	0.020	0.036	0.070		X
PTR016V0300	16	100	3.00	5.10	2.30	15.00	1.00	0.038	0.065	0.098	X	X
PTR016V0400	16	100	4.00	6.80	2.40	20.00	1.70	0.021	0.038	0.060	X	X
PTR016V0500	16	100	5.00	8.50	2.60	25.00	2.00	0.010	0.023	0.034	X	X
PTR016V0600	16	100	6.00	10.20	2.80	30.00	3.30	0.006	0.018	0.028	X	X
PTR016V0700	16	100	7.00	11.90	3.00	35.00	3.50	0.006	0.013	0.020	X	X
PTR016V0800	16	100	8.00	13.60	3.00	40.00	5.00	0.005	0.011	0.018	X	X
PTR016V0900	16	100	9.00	15.30	3.30	45.00	5.50	0.005	0.009	0.014	X	X
PTR016V1000	16	100	10.00	17.00	3.60	50.00	6.00	0.004	0.007	0.010	X	X
PTR016V1100	16	100	11.00	18.70	3.70	55.00	7.00	0.003	0.006	0.009	X	X
PTR016V1200	16	100	12.00	20.40	4.20	60.00	7.50	0.003	0.006	0.009	X	X
PTR016V1300	16	100	13.00	22.10	4.60	65.00	8.50	0.002	0.006	0.008	X	X
PTR016V1400	16	100	14.00	23.80	4.60	70.00	9.00	0.002	0.005	0.007	X	X
PTR016V1500	16	100	15.00	25.50	4.60	75.00	10.00	0.002	0.005	0.007	X	X

Notes: I<sub>hold</sub> – Hold current: Maximum current device will pass without interruption in +23 °C still air.  
 I<sub>trip</sub> – Trip current: Minimum current that will switch the device from low resistance to high resistance in +23 °C still air.  
 V<sub>max</sub>: Maximum continuous voltage device can withstand without damage at rated current.  
 I<sub>max</sub>: Maximum fault current device can withstand without damage at rated voltage.  
 Pd: Power dissipated from device when in the tripped state in +23 °C still air.  
 R<sub>i</sub> (min.): Minimum resistance of device as supplied at +23 °C unless otherwise specified.  
 R<sub>i</sub> (max.): Maximum resistance of device when measured one hour post reflow (SMD) or one hour post trip (radial-leaded device) at +23 °C unless otherwise specified.



Powering Business Worldwide

Dimensions - mm

Part Number	A Max.	B Max Lead Type		C	D Min.	E Max.	F	Figure/Lead Style	
		Straight (-TR)	Kink (-TR1)					Straight TR	Kink TR1
PTR016V0090	7.4	12.2	12.2	5.0±0.8	7.6	3.5	0.5±0.02	2	1
PTR016V0110	7.4	14.2	14.2	5.0±0.8	7.6	3.5	0.5±0.02	2	1
PTR016V0135	8.9	13.5	13.5	5.0±0.8	7.6	3.5	0.5±0.02	2	1
PTR016V0160	8.9	15.2	15.2	5.0±0.8	7.6	3.5	0.5±0.02	2	1
PTR016V0185	10.2	15.7	15.7	5.0±0.8	7.6	3.5	0.5±0.02	2	1
PTR016V0250	11.4	18.3	20.5	5.0±0.8	7.6	3.5	0.5±0.02	2	1
PTR016V0300	7.1	11.0	14.0	5.0±0.8	7.6	3.5	0.8±0.02	2	1
PTR016V0400	8.9	12.8	14.8	5.0±0.8	7.6	3.5	0.8±0.02	2	1
PTR016V0500	10.4	14.3	16.0	5.0±0.8	7.6	3.5	0.8±0.02	2	1
PTR016V0600	10.7	17.1	19.0	5.0±0.8	7.6	3.5	0.8±0.02	2	1
PTR016V0700	11.2	19.7	22.0	5.0±0.8	7.6	3.5	0.8±0.02	2	1
PTR016V0800	12.7	20.9	23.0	5.0±0.8	7.6	3.5	0.8±0.02	2	1
PTR016V0900	14.0	21.9	24.0	5.0±0.8	7.6	3.5	0.8±0.02	2	1
PTR016V1000	16.5	25.2	28.0	5.0±0.8	7.6	3.5	0.8±0.02	2	1
PTR016V1100	17.5	26.0	29.0	5.0±0.8	7.6	3.5	0.8±0.02	2	1
PTR016V1200	17.5	28.0	31.0	10.0±0.8	7.6	3.5	1.0±0.02	2	1
PTR016V1300	21.6	29.2	32.0	10.0±0.8	7.6	3.5	1.0±0.02	2	1
PTR016V1400	23.5	27.9	30.0	10.0±0.8	7.6	3.5	1.0±0.02	2	1
PTR016V1500	25.1	29.0	32.0	10.0±0.8	7.6	3.5	1.0±0.02	2	1

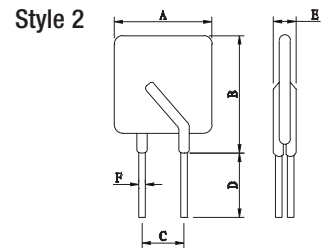
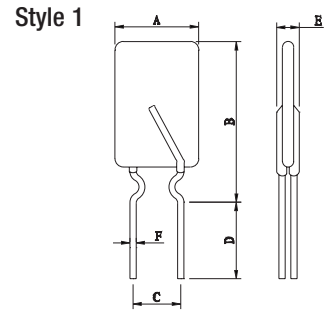

Packaging/Taping Specifications

Description	IEC Mark	Dimension (mm)	Tolerance (mm)
Sprocket hole pitch	P <sub>0</sub>	12.7	±0.3
Ordinate to adjacent component lead:			
PTR016V0090~PTR016V0250	P <sub>1</sub>	3.6	±1.0
PTR016V0300~PTR016V1100	P <sub>1</sub>	4.5	±1.0
PTR016V1200~PTR016V1500	P <sub>1</sub>	7.2	±1.0
Device pitch:			
PTR016V0090~PTR016V0600	P	12.7	±1.0
PTR016V0700~PTR016V1400	P	25.4	±1.0
PTR016V1500	P	38.1	±1.0
Lead spacing	C	*	--
Carrier tape width	W	18	±1.0
Top distance between tape edges	W <sub>0</sub>	3.0	Max.
Hold-down tape width	W <sub>1</sub>	12	±1.0
Sprocket hole position	W <sub>2</sub>	9.0	+0.75/-0.5
Abscissa to top:			
PTR016V0090~PTR016V0600	H <sub>1</sub>	32.2	Max.
PTR016V0700~PTR016V1500	H <sub>1</sub>	47.5	Max.
Abscissa to plane			
(straight lead)	H	18.0	+2/-0
(kinked lead)	H <sub>0</sub>	16.0	±0.5
Sprocket hole diameter	D <sub>0</sub>	4	±0.2
Lead protrusion	L <sub>1</sub>	1	Max.
Tape thickness	t	0.9	Max.
Body lateral deviation	Δ <sub>h</sub>	0	±1.0
Body tape plane deviation	Δ <sub>p</sub>	0	±1.3
Reel width	W <sub>3</sub>	56	Max.
Reel diameter		340	±10
Arbor hole diameter	n <sub>0</sub>	31	±1
Core diameter	n	80	Min.

\* See Dimensions table.

Style 1 - PTR016V0090, PTR016V0110, PTR016V0135, PTR016V0160-PTR016V1000

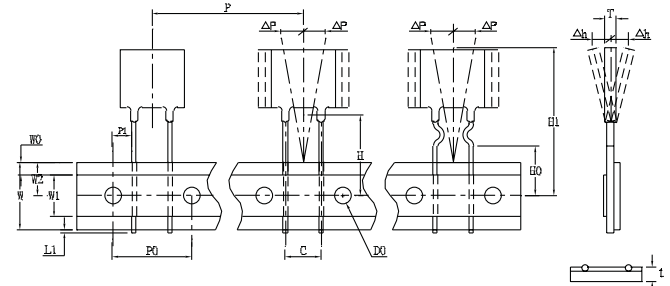

Style 2 - PTR016V1200-PTR016V1500

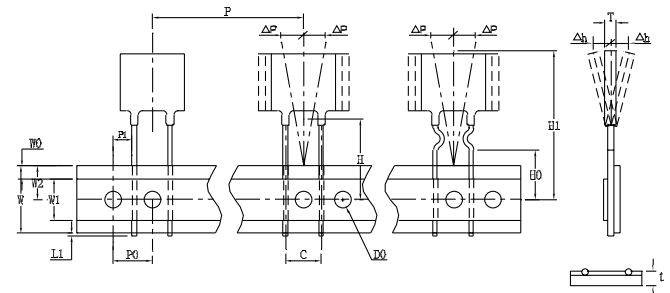

Reel Specifications

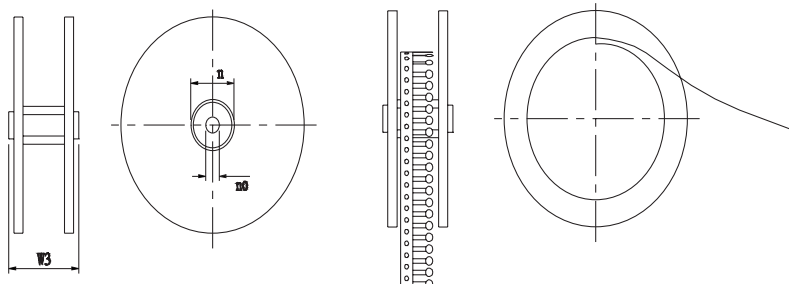

Time-to-Trip Curves at +23 °C - 0.9-2.5 A

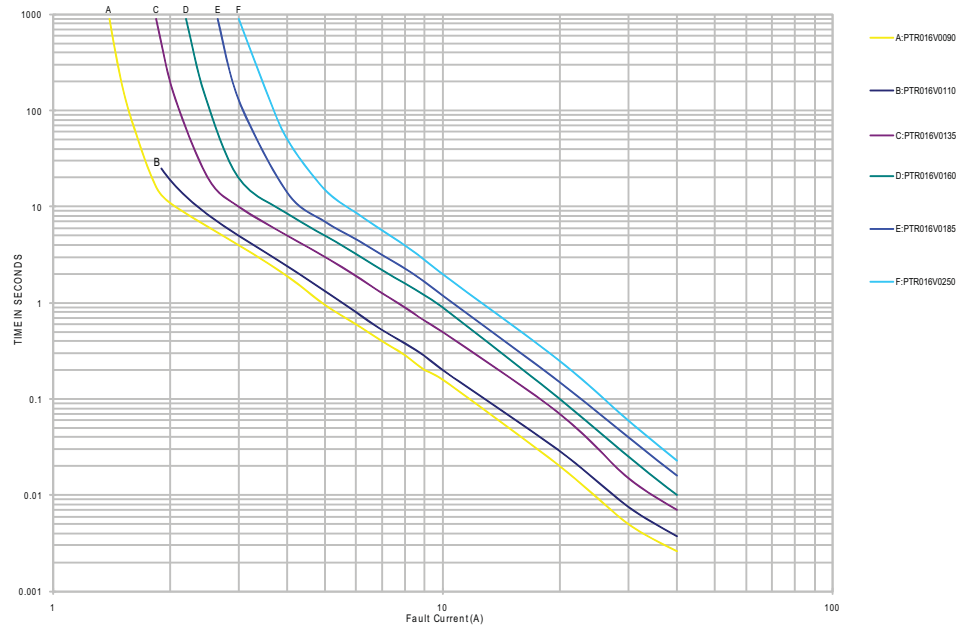

Time-to-Trip Curves at +23 °C - 3.0-15 A

