

PTR030V

30 Volt DC radial leaded, PolyTron™ PTC devices



Product features

- PolyTron™ radial leaded thru-hole PTC device
- Maximum 30 V
- Current ratings from 0.90 A to 9.00 A
- Fast time-to-trip
- Low resistance
- Halogen free, Lead free, RoHS compliant

Applications

- Medical equipment
- White goods
- Industrial power transmission
- Telecommunications
- Computers and peripherals
- Consumer and automotive electronics
- Rechargeable battery packs

Agency information

- cURus: Recognized Card: File E343021 (Ihold 0.9-9 A)
- TUV File: J 50194729

Ordering information/ part number system

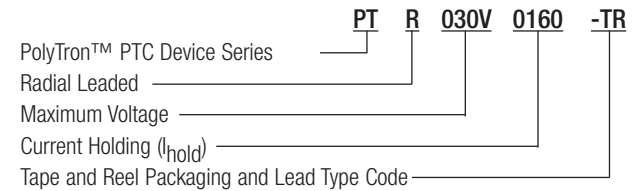

Lead Codes: TR & BK - Straight Leads, TR1 & BK1 - Kinked Leads

TR & TR1 On Reels

- 0.90-1.60 A - 3000 devices
- 1.85-3.00 A - 2000 devices
- 4.00-9.00 A - 1000 devices

BK & BK1 In Poly Bags

- 0.90-1.35 A - 1,000 devices
- 1.60-6.00 A - 500 devices
- 7.00-9.00 A - 250 devices

Specifications

Catalog Number	V _{max} (Vdc)	I _{max} (A)	I _{hold} @+23 °C (A)	I _{trip} @+23 °C (A)	P _d Typ. (W)	Time to Trip (Max.)		Resistance (Ω)			Agency Information	
						(A)	(sec)	Initial (R _i)		Post Trip (R _t) Max.	cURus	TUV
								Min.	Max.			
PTR030V0090	30	40	0.90	1.80	0.6	4.50	5.90	0.070	0.120	0.22	X	X
PTR030V0110	30	40	1.10	2.20	0.7	5.50	6.60	0.050	0.100	0.17	X	X
PTR030V0135	30	40	1.35	2.70	0.8	6.75	7.30	0.040	0.080	0.13	X	X
PTR030V0160	30	40	1.60	3.20	0.9	8.00	8.00	0.030	0.070	0.11	X	X
PTR030V0185	30	40	1.85	3.70	1.0	9.25	8.70	0.030	0.060	0.09	X	X
PTR030V0250	30	40	2.50	5.00	1.2	12.50	10.30	0.020	0.040	0.07	X	X
PTR030V0300	30	40	3.00	6.00	2.0	15.00	10.80	0.020	0.050	0.08	X	X
PTR030V0400	30	40	4.00	8.00	2.5	20.00	12.70	0.010	0.030	0.05	X	X
PTR030V0500	30	40	5.00	10.00	3.0	25.00	14.50	0.010	0.030	0.05	X	X
PTR030V0600	30	100	6.00	12.00	3.5	30.00	16.00	0.005	0.020	0.04	X	X
PTR030V0700	30	100	7.00	14.00	3.8	35.00	17.50	0.005	0.020	0.03	X	X
PTR030V0800	30	100	8.00	16.00	4.0	40.00	18.80	0.005	0.013	0.02	X	X
PTR030V0900	30	100	9.00	18.00	4.2	45.00	20.00	0.005	0.010	0.02	X	X

Notes: I_{hold} – Hold current: Maximum current device will pass without interruption in +23 °C still air.
 I_{trip} – Trip current: Minimum current that will switch the device from low resistance to high resistance in +23 °C still air.
 V_{max}: Maximum continuous voltage device can withstand without damage at rated current.
 I_{max}: Maximum fault current device can withstand without damage at rated voltage.
 P_d: Power dissipated from device when in the tripped state in +23 °C still air.
 R_i (min.): Minimum resistance of device as supplied at +23 °C unless otherwise specified.
 R_i (max.): Maximum resistance of device as supplied at +23 °C unless otherwise specified.
 R_t (max.): Maximum resistance of device when measured one hour post reflow (SMD) or one hour post trip (radial-leaded device) at +23 °C unless otherwise specified.



Powering Business Worldwide

Dimensions - mm

Part Number	A Max.	B Max Lead Type		C	D Min.	E Max.	F	Figure/Lead Style	
		Straight (-TR)	Kink (-TR1)					Straight TR	Kink TR1
PTR030V0090	7.4	12.2	12.2	5.0±0.8	7.6	3.5	0.5±0.02	2	1
PTR030V0110	7.4	14.2	14.2	5.0±0.8	7.6	3.5	0.5±0.02	2	1
PTR030V0135	8.9	13.5	13.5	5.0±0.8	7.6	3.5	0.5±0.02	2	1
PTR030V0160	8.9	15.2	15.2	5.0±0.8	7.6	3.5	0.5±0.02	2	1
PTR030V0185	10.2	15.7	15.7	5.0±0.8	7.6	3.5	0.5±0.02	2	1
PTR030V0250	11.4	18.3	20.5	5.0±0.8	7.6	3.5	0.5±0.02	2	1
PTR030V0300	11.4	17.3	21.8	5.0±0.8	7.6	3.5	0.8±0.02	2	1
PTR030V0400	14.0	20.1	24.6	5.0±0.8	7.6	3.5	0.8±0.02	2	1
PTR030V0500	14.0	24.9	26.6	10.0±0.8	7.6	3.5	0.8±0.02	2	1
PTR030V0600	16.5	24.9	29.4	10.0±0.8	7.6	3.5	0.8±0.02	2	1
PTR030V0700	19.1	26.7	31.2	10.0±0.8	7.6	3.5	0.8±0.02	2	1
PTR030V0800	21.6	29.2	33.7	10.0±0.8	7.6	3.5	0.8±0.02	2	1
PTR030V0900	24.1	29.7	34.2	10.0±0.8	7.6	3.5	0.8±0.02	2	1

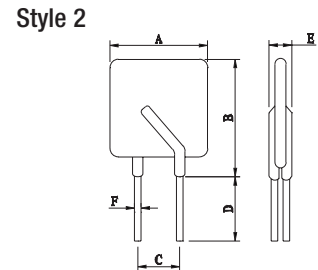
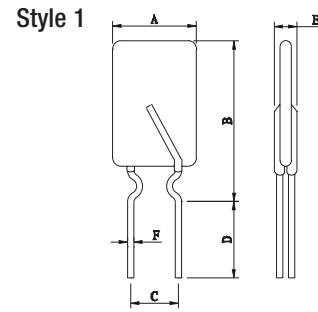

Packaging/Taping Specifications

Description	IEC Mark	Dimension (mm)	Tolerance (mm)
Sprocket hole pitch	P ₀	12.7	0.3
Ordinate to adjacent component lead PTR030V0090~PTR030V0300	P ₁	3.6	1.0
Ordinate to adjacent component lead PTR030V0400	P ₁	3.45	1.0
Ordinate to adjacent component lead PTR030V0500~PTR030V0900	P ₁	7.3	1.0
Device pitch PTR030V0090~PTR030V0300	P	12.7	1.0
Device pitch PTR030V0400~PTR030V0900	P	25.4	1.0
Lead spacing	C	*	--
Carrier tape width	W	18	1.0
Top distance between tape edges	W ₀	3.0	Max.
Hold-down tape width	W ₁	12	1.0
Sprocket hole position	W ₂	9.0	+0.75/-0.5
Abscissa to top PTR030V0090~PTR030V0300	H ₁	32.2	Max.
Abscissa to top PTR030V0400~PTR030V0900	H ₁	47.5	Max.
Abscissa to plane (straight lead)	H	18.0	+2/-0
Abscissa to plane (kinked lead)	H ₀	16.0	±0.5
Sprocket hole diameter	D ₀	4	±0.2
Lead protrusion	L ₁	1	Max.
Tape thickness	t	0.9	Max.
Body lateral deviation	Δ _h	0	±1.0
Body tape plane deviation	Δ _p	0	±0.13
Reel width	W ₃	56	Max.
Reel diameter		340	±10
Arbor hole diameter	n ₀	31	±1
Core diameter	n	80	Min.

* See Dimensions table.

Figure 1 - PTR030V0090-PTR030V0400

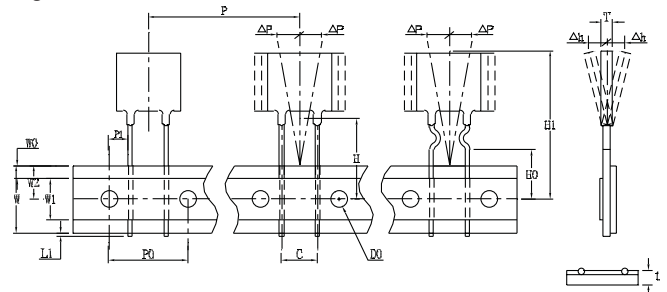
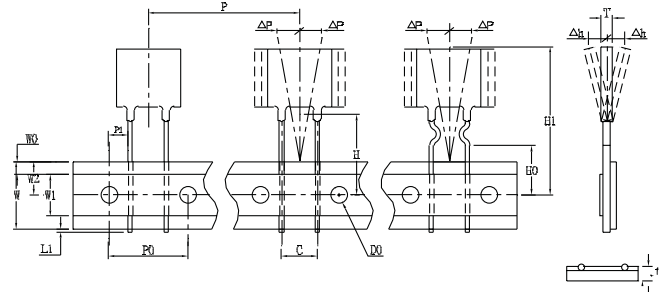
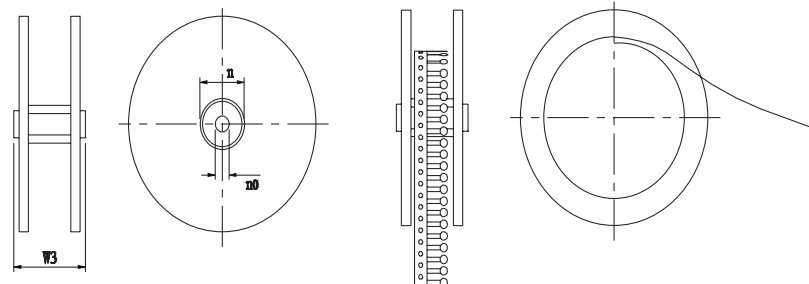

Figure 2 - PTR030V0500-PTR030V0900



Reel specification



Time-to-Trip Curves at +23 °C

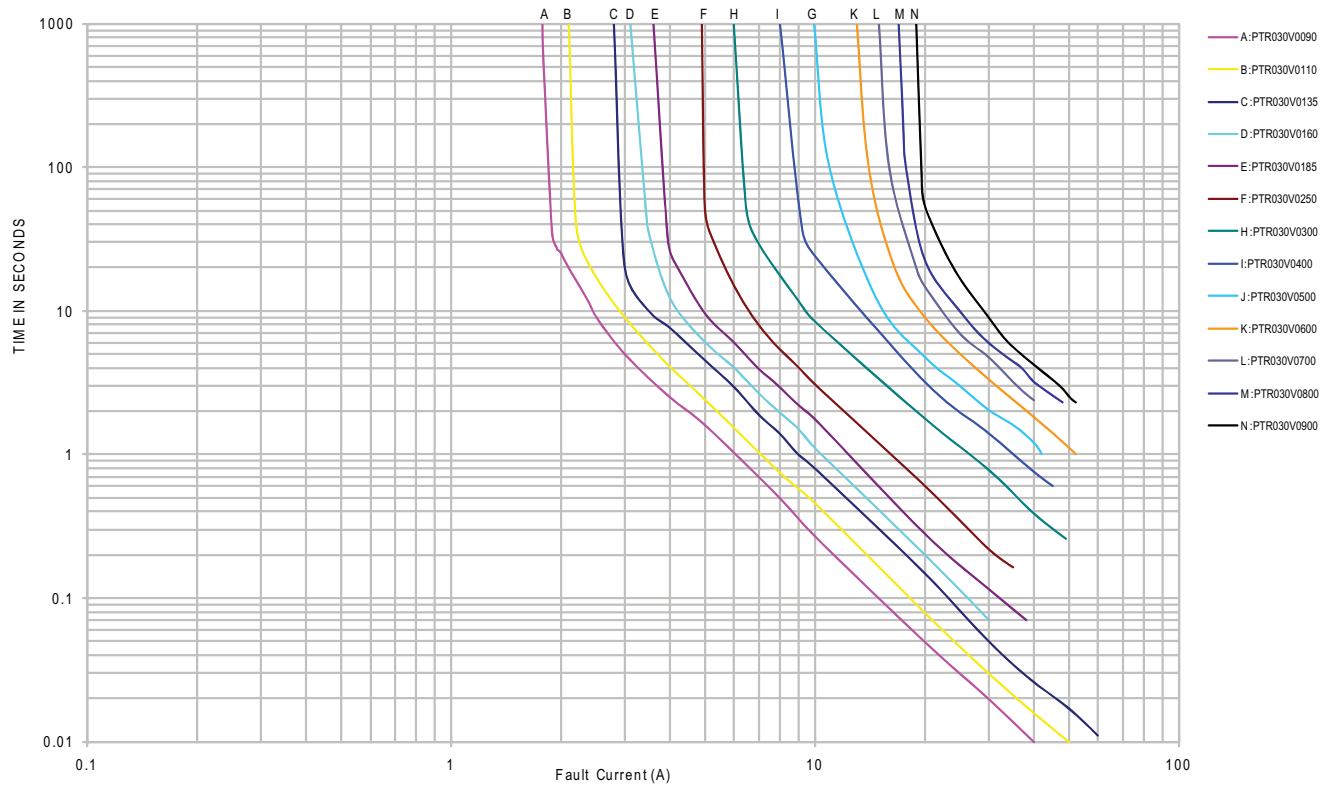

Thermal Derating Curve

