

PTR030V

30 Volt DC radial leaded, PolyTron™ PTC devices



Product features

- PolyTron™ radial leaded thru-hole PTC device
- Maximum 30 V
- Current ratings from 0.90 A to 9.00 A
- Fast time-to-trip
- Low resistance
- Halogen free, Lead free, RoHS compliant

Applications

- Medical equipment
- White goods
- Industrial power transmission
- Telecommunications
- Computers and peripherals
- Consumer and automotive electronics
- Rechargeable battery packs

Agency information

- cURus: Recognized Card: File E343021 (Ihold 0.9-9 A)
- TUV File: J 50194729

Ordering information/ part number system

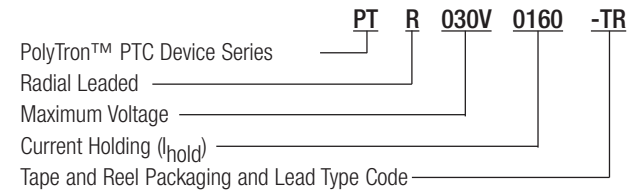

Lead Codes: TR & BK - Straight Leads, TR1 & BK1 - Kinked Leads

TR & TR1 On Reels

- 0.90-1.60 A - 3000 devices
- 1.85-3.00 A - 2000 devices
- 4.00-9.00 A - 1000 devices

BK & BK1 In Poly Bags

- 0.90-1.35 A - 1,000 devices
- 1.60-6.00 A - 500 devices
- 7.00-9.00 A - 250 devices

Specifications

| Catalog Number | V _{max} (Vdc) | I _{max} (A) | I _{hold} @+23 °C (A) | I _{trip} @+23 °C (A) | P _d Typ. (W) | Time to Trip (Max.) | | Resistance (Ω) | | | Agency Information | |
|----------------|------------------------|----------------------|-------------------------------|-------------------------------|-------------------------|---------------------|-------|---------------------------|-------|----------------------------------|--------------------|-----|
| | | | | | | (A) | (sec) | Initial (R _i) | | Post Trip (R _t) Max. | cURus | TUV |
| | | | | | | | | Min. | Max. | | | |
| PTR030V0090 | 30 | 40 | 0.90 | 1.80 | 0.6 | 4.50 | 5.90 | 0.070 | 0.120 | 0.22 | X | X |
| PTR030V0110 | 30 | 40 | 1.10 | 2.20 | 0.7 | 5.50 | 6.60 | 0.050 | 0.100 | 0.17 | X | X |
| PTR030V0135 | 30 | 40 | 1.35 | 2.70 | 0.8 | 6.75 | 7.30 | 0.040 | 0.080 | 0.13 | X | X |
| PTR030V0160 | 30 | 40 | 1.60 | 3.20 | 0.9 | 8.00 | 8.00 | 0.030 | 0.070 | 0.11 | X | X |
| PTR030V0185 | 30 | 40 | 1.85 | 3.70 | 1.0 | 9.25 | 8.70 | 0.030 | 0.060 | 0.09 | X | X |
| PTR030V0250 | 30 | 40 | 2.50 | 5.00 | 1.2 | 12.50 | 10.30 | 0.020 | 0.040 | 0.07 | X | X |
| PTR030V0300 | 30 | 40 | 3.00 | 6.00 | 2.0 | 15.00 | 10.80 | 0.020 | 0.050 | 0.08 | X | X |
| PTR030V0400 | 30 | 40 | 4.00 | 8.00 | 2.5 | 20.00 | 12.70 | 0.010 | 0.030 | 0.05 | X | X |
| PTR030V0500 | 30 | 40 | 5.00 | 10.00 | 3.0 | 25.00 | 14.50 | 0.010 | 0.030 | 0.05 | X | X |
| PTR030V0600 | 30 | 100 | 6.00 | 12.00 | 3.5 | 30.00 | 16.00 | 0.005 | 0.020 | 0.04 | X | X |
| PTR030V0700 | 30 | 100 | 7.00 | 14.00 | 3.8 | 35.00 | 17.50 | 0.005 | 0.020 | 0.03 | X | X |
| PTR030V0800 | 30 | 100 | 8.00 | 16.00 | 4.0 | 40.00 | 18.80 | 0.005 | 0.013 | 0.02 | X | X |
| PTR030V0900 | 30 | 100 | 9.00 | 18.00 | 4.2 | 45.00 | 20.00 | 0.005 | 0.010 | 0.02 | X | X |

Notes: I_{hold} – Hold current: Maximum current device will pass without interruption in +23 °C still air.
 I_{trip} – Trip current: Minimum current that will switch the device from low resistance to high resistance in +23 °C still air.
 V_{max}: Maximum continuous voltage device can withstand without damage at rated current.
 I_{max}: Maximum fault current device can withstand without damage at rated voltage.
 P_d: Power dissipated from device when in the tripped state in +23 °C still air.
 R_i (min.): Minimum resistance of device as supplied at +23 °C unless otherwise specified.
 R_i (max.): Maximum resistance of device as supplied at +23 °C unless otherwise specified.
 R_t (max.): Maximum resistance of device when measured one hour post reflow (SMD) or one hour post trip (radial-leaded device) at +23 °C unless otherwise specified.



Powering Business Worldwide

Dimensions - mm

| Part Number | A Max. | B Max Lead Type | | C | D Min. | E Max. | F | Figure/Lead Style | |
|-------------|--------|-----------------|-------------|----------|--------|--------|----------|-------------------|----------|
| | | Straight (-TR) | Kink (-TR1) | | | | | Straight TR | Kink TR1 |
| PTR030V0090 | 7.4 | 12.2 | 12.2 | 5.0±0.8 | 7.6 | 3.5 | 0.5±0.02 | 2 | 1 |
| PTR030V0110 | 7.4 | 14.2 | 14.2 | 5.0±0.8 | 7.6 | 3.5 | 0.5±0.02 | 2 | 1 |
| PTR030V0135 | 8.9 | 13.5 | 13.5 | 5.0±0.8 | 7.6 | 3.5 | 0.5±0.02 | 2 | 1 |
| PTR030V0160 | 8.9 | 15.2 | 15.2 | 5.0±0.8 | 7.6 | 3.5 | 0.5±0.02 | 2 | 1 |
| PTR030V0185 | 10.2 | 15.7 | 15.7 | 5.0±0.8 | 7.6 | 3.5 | 0.5±0.02 | 2 | 1 |
| PTR030V0250 | 11.4 | 18.3 | 20.5 | 5.0±0.8 | 7.6 | 3.5 | 0.5±0.02 | 2 | 1 |
| PTR030V0300 | 11.4 | 17.3 | 21.8 | 5.0±0.8 | 7.6 | 3.5 | 0.8±0.02 | 2 | 1 |
| PTR030V0400 | 14.0 | 20.1 | 24.6 | 5.0±0.8 | 7.6 | 3.5 | 0.8±0.02 | 2 | 1 |
| PTR030V0500 | 14.0 | 24.9 | 26.6 | 10.0±0.8 | 7.6 | 3.5 | 0.8±0.02 | 2 | 1 |
| PTR030V0600 | 16.5 | 24.9 | 29.4 | 10.0±0.8 | 7.6 | 3.5 | 0.8±0.02 | 2 | 1 |
| PTR030V0700 | 19.1 | 26.7 | 31.2 | 10.0±0.8 | 7.6 | 3.5 | 0.8±0.02 | 2 | 1 |
| PTR030V0800 | 21.6 | 29.2 | 33.7 | 10.0±0.8 | 7.6 | 3.5 | 0.8±0.02 | 2 | 1 |
| PTR030V0900 | 24.1 | 29.7 | 34.2 | 10.0±0.8 | 7.6 | 3.5 | 0.8±0.02 | 2 | 1 |

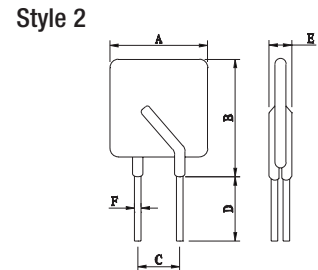
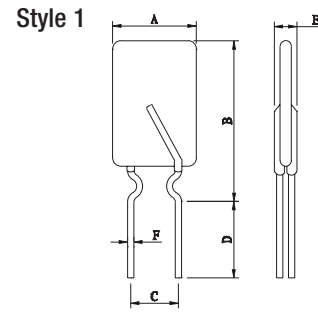

Packaging/Taping Specifications

| Description | IEC Mark | Dimension (mm) | Tolerance (mm) |
|---|----------------|----------------|----------------|
| Sprocket hole pitch | P ₀ | 12.7 | 0.3 |
| Ordinate to adjacent component lead PTR030V0090~PTR030V0300 | P ₁ | 3.6 | 1.0 |
| Ordinate to adjacent component lead PTR030V0400 | P ₁ | 3.45 | 1.0 |
| Ordinate to adjacent component lead PTR030V0500~PTR030V0900 | P ₁ | 7.3 | 1.0 |
| Device pitch PTR030V0090~PTR030V0300 | P | 12.7 | 1.0 |
| Device pitch PTR030V0400~PTR030V0900 | P | 25.4 | 1.0 |
| Lead spacing | C | * | -- |
| Carrier tape width | W | 18 | 1.0 |
| Top distance between tape edges | W ₀ | 3.0 | Max. |
| Hold-down tape width | W ₁ | 12 | 1.0 |
| Sprocket hole position | W ₂ | 9.0 | +0.75/-0.5 |
| Abscissa to top PTR030V0090~PTR030V0300 | H ₁ | 32.2 | Max. |
| Abscissa to top PTR030V0400~PTR030V0900 | H ₁ | 47.5 | Max. |
| Abscissa to plane (straight lead) | H | 18.0 | +2/-0 |
| Abscissa to plane (kinked lead) | H ₀ | 16.0 | ±0.5 |
| Sprocket hole diameter | D ₀ | 4 | ±0.2 |
| Lead protrusion | L ₁ | 1 | Max. |
| Tape thickness | t | 0.9 | Max. |
| Body lateral deviation | Δ _h | 0 | ±1.0 |
| Body tape plane deviation | Δ _p | 0 | ±0.13 |
| Reel width | W ₃ | 56 | Max. |
| Reel diameter | | 340 | ±10 |
| Arbor hole diameter | n ₀ | 31 | ±1 |
| Core diameter | n | 80 | Min. |

* See Dimensions table.

Figure 1 - PTR030V0090-PTR030V0400

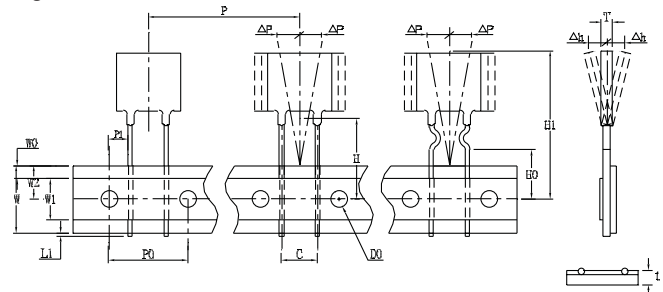
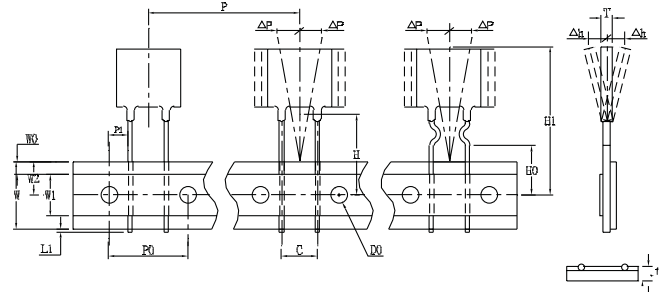
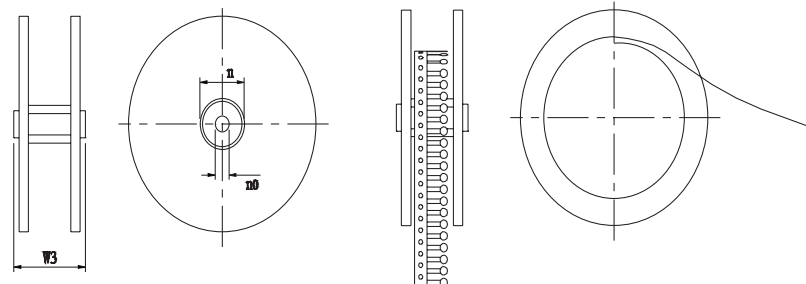

Figure 2 - PTR030V0500-PTR030V0900



Reel specification



Time-to-Trip Curves at +23 °C

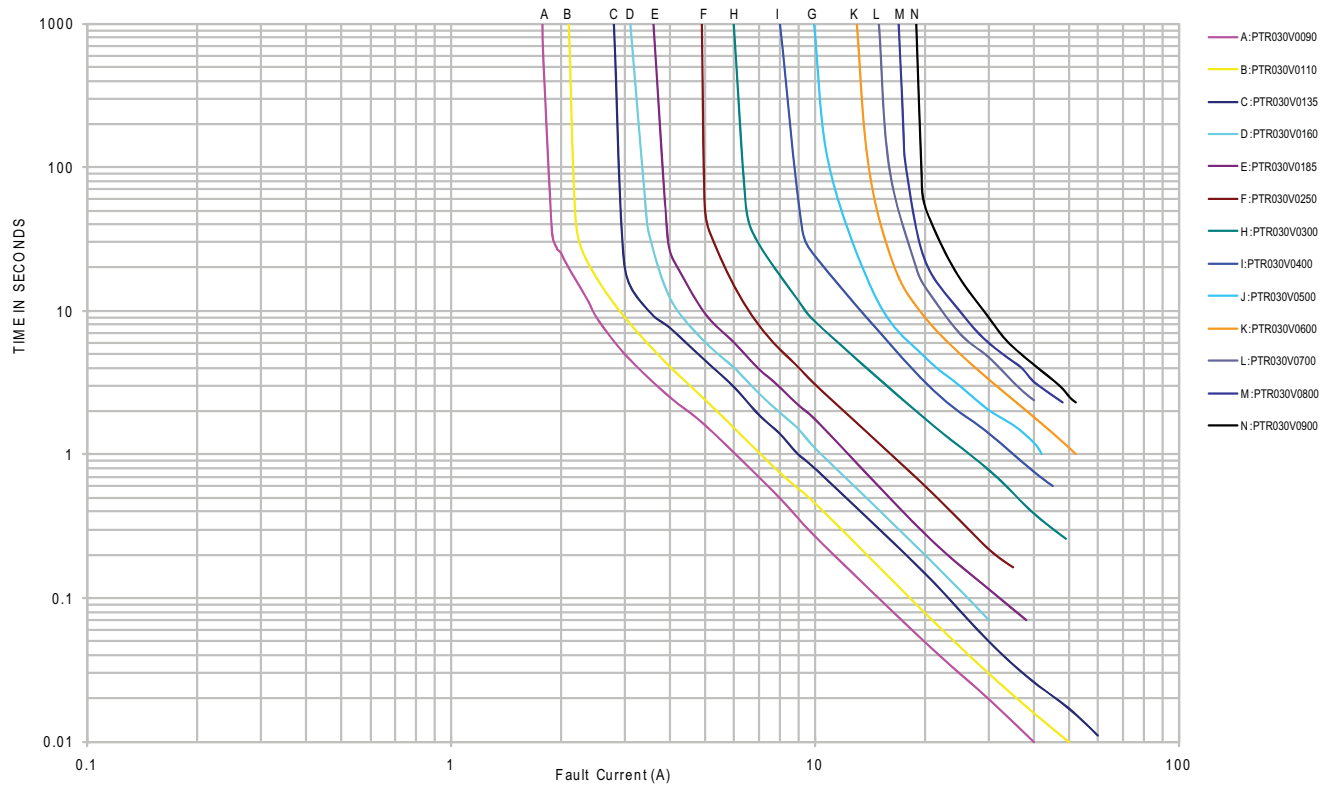

Thermal Derating Curve

