

## Features

- Carbon element
- Ganging up to 8 sections available
- Knurled and flatted shaft styles
- Audio taper option
- Tracking error within 3 dB
- RoHS compliant\*

## PTR90 Series - 9 mm Multi-Ganged Potentiometer w/Rotary Switch

### Product Dimensions

#### PTR901

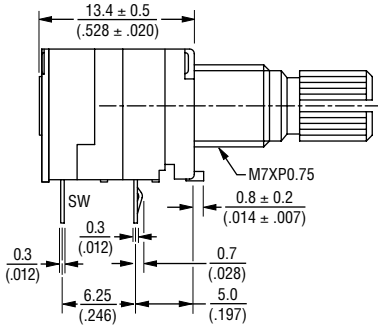

#### RECOMMENDED PCB LAYOUT

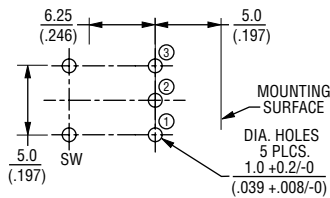

#### SCHEMATIC

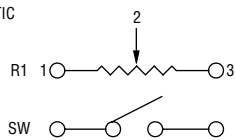

DIMENSIONS:  $\frac{\text{MM}}{\text{(INCHES)}}$

### Derating Curve

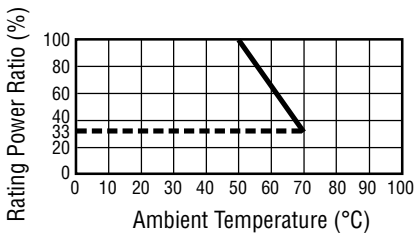

**WARNING**  
**Cancer and Reproductive Harm**  
[www.P65Warnings.ca.gov](http://www.P65Warnings.ca.gov)

\*RoHS Directive 2015/863, Mar 31, 2015 and Annex.  
 \*\*Devices are tested using standard noise reduction filters. For optimum performance, designers should use noise reduction filters in their circuits. Specifications are subject to change without notice. Users should verify actual device performance in their specific applications. The products described herein and this document are subject to specific legal disclaimers as set forth on the last page of this document, and at [www.bourns.com/docs/legal/disclaimer.pdf](http://www.bourns.com/docs/legal/disclaimer.pdf).

#### PTR902

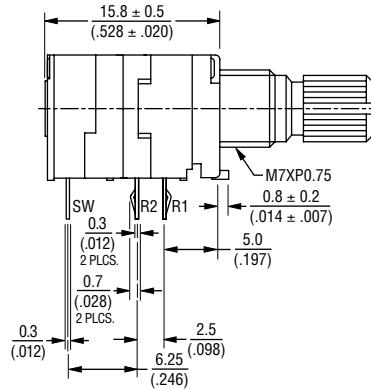

#### RECOMMENDED PCB LAYOUT

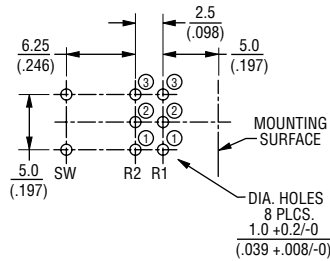

#### SCHEMATIC

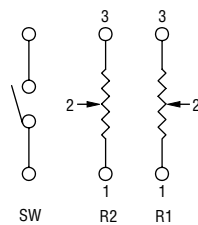

### Standard Resistance Table

Resistance (Ohms)	Resistance Code
1,000	102
2,000	202
5,000	502
10,000	103
20,000	203
50,000	503
100,000	104
200,000	204
500,000	504
1,000,000	105



### CAUTION

Do not store product in high temperature and humidity, direct sunlight and/or places where corrosive gases may be generated. Please use product within 6 months from the date of delivery and promptly after unpacking.

### Additional Information

Click these links for more information:



### Electrical Characteristics

Standard Resistance Range ..... 1 K ohms to 1 M ohms  
 Total Resistance Tolerance ..... ±10 % or ±20 %  
 Standard Tapers ..... Linear & audio  
 Maximum Operating Voltage ..... 150 VAC, 20 VDC  
 Rated Power  
 Linear Taper ..... 0.05 watts  
 Audio Taper ..... 0.025 watts  
 Noise ..... 100 mV max.  
 Insulation Resistance @ 250 VDC ..... 100 M ohms  
 Dielectric Withstanding Voltage ..300 VAC  
 End Resistance ..... 20 ohms max.  
 Tracking Error (-40 dB to 0 dB) ..... ±3 dB

### Environmental Characteristics

Operating Temperature ..... -10 °C to +50 °C  
 Rotational Life..... 15,000 cycles  
 IP Rating..... IP 40

### Switch Characteristics

Contact Resistance .... 50 milliohms max.  
 Rated Power..... 3 A @ 16 VDC  
 Detent Torque ..... 400 g-cm max.  
 Switch Activation Angle.....50 ° max.

### Mechanical Characteristics

Mechanical Angle ..... 300 ° ±10 °  
 Running Torque ..... 10 to 250 g-cm  
 Stop Strength..... 4.0 kg-cm  
 Shaft Push/Pull Strength ..... 5.0 kgf min.  
 Shaft Wobble ..... 0.6 x L/20 mm p-p max.  
 Mounting Torque..... 7.0 kg-cm min.  
 Soldering Condition  
 Manual Soldering  
 .....96.5 Sn/3.0 Ag/0.5 Cu solid wire  
 ..... or no-clean rosin cored wire  
 ..... 270 °C max. for 3 seconds  
 Wave Soldering  
 .....96.5 Sn/3.0 Ag/0.5 Cu solder  
 ..... with no-clean flux  
 ..... 260 °C max. for 5 seconds  
 Wash Process ..... Not recommended  
 Mounting Hardware .....One flat washer  
 .....and one mounting nut supplied  
 .....per potentiometer

# Applications

- Audio/TV sets
- Automotive sound systems
- Amplifiers/mixers/drum machines/synthesizers/DJ equipment
- Multimedia sound systems
- Portable electronics

## PTR90 Series – 9 mm Multi-Ganged Potentiometer w/Rotary Switch **BOURNS®**

### Product Dimensions

**PTR904**

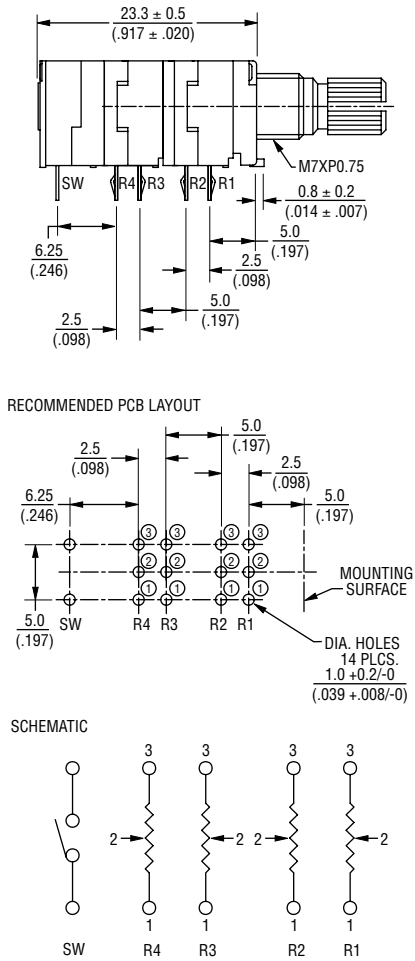

**PTR906**

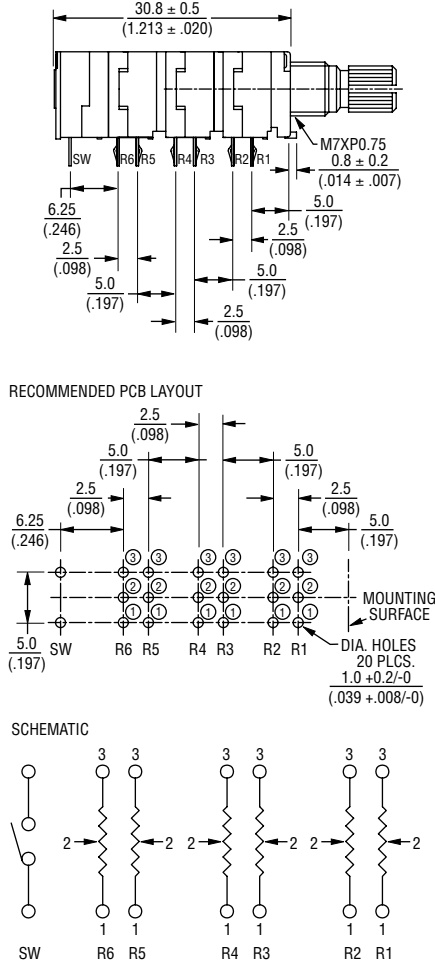

**PTR908**

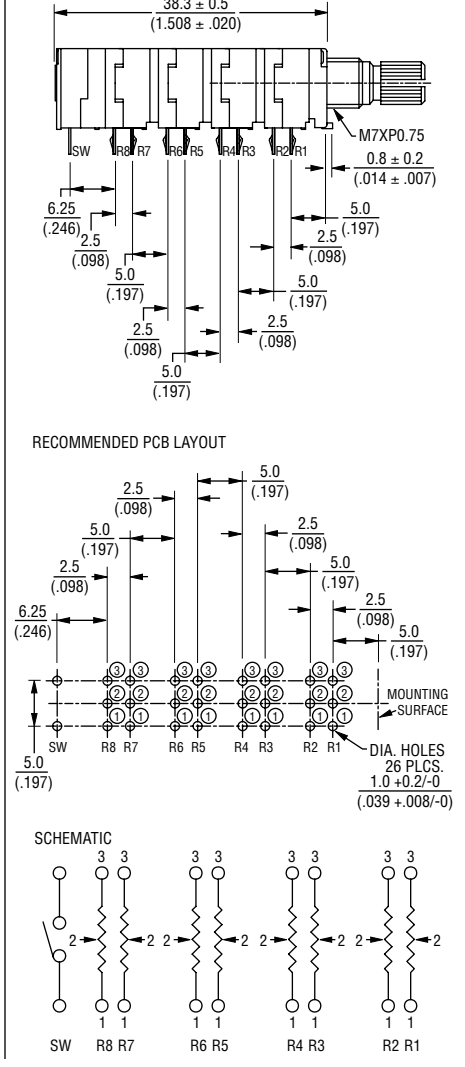

DIMENSIONS:  $\frac{\text{MM}}{\text{(INCHES)}}$

# BOURNS®

**Asia-Pacific:** Tel: +886-2 2562-4117 • Email: asiacus@bourns.com  
**EMEA:** Tel: +36 88 885 877 • Email: eurocus@bourns.com  
**The Americas:** Tel: +1-951 781-5500 • Email: americus@bourns.com  
[www.bourns.com](http://www.bourns.com)

Specifications are subject to change without notice. Users should verify actual device performance in their specific applications. The products described herein and this document are subject to specific legal disclaimers as set forth on the last page of this document, and at [www.bourns.com/docs/legal/disclaimer.pdf](http://www.bourns.com/docs/legal/disclaimer.pdf).

# PTR90 Series – 9 mm Multi-Ganged Potentiometer w/Rotary Switch



## Product Dimensions

### SHAFT STYLE "K"

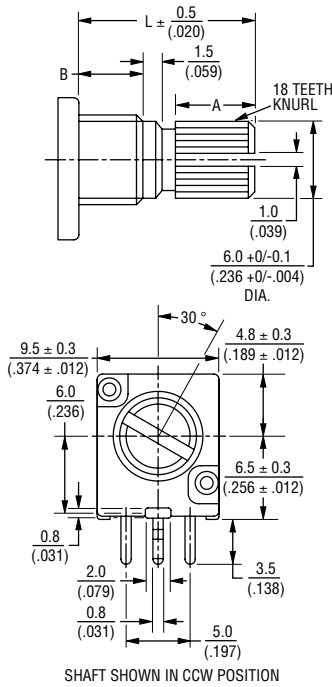

DIMENSIONS:  $\frac{\text{MM}}{\text{(INCHES)}}$

### SHAFT STYLE "F"

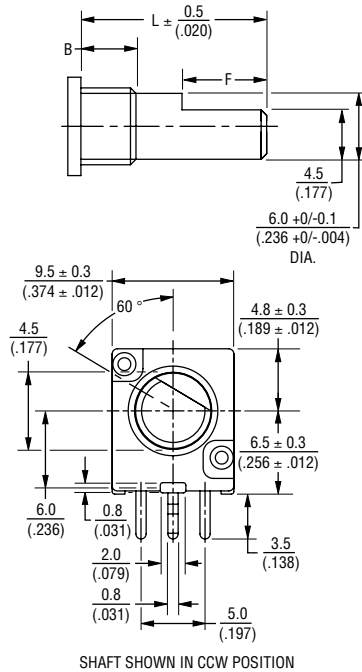

DIMENSIONS:  $\frac{\text{MM}}{\text{(INCHES)}}$

## How To Order

**PTR90 1 - 2 0 20 K - B 203**

- Model
- PTR90 = With Rotary Switch
- No. of Sections
- 1 = 1 Section
  - 2 = 2 Sections
  - 3 = 3 Sections
  - 4 = 4 Sections
  - 5 = 5 Sections
  - 6 = 6 Sections
  - 8 = 8 Sections
- Pin Style
- 1 = PC Pins vertical/down facing and  $\pm 10\%$  Total Resistance Tolerance
  - 2 = PC Pins vertical/down facing and  $\pm 20\%$  Total Resistance Tolerance
- Center Detent Option
- 0 = No Detent
  - 2 = Center Detent
- Standard Shaft Length
- 15 = 15 mm
  - 20 = 20 mm
  - 25 = 25 mm
- Shaft Styles
- K = Knurled Type Shaft (Metal) 18 Toothed Serration Type
  - F = Flatted Metal Shaft
- Resistance Taper (See Taper Charts)
- Taper Series followed by Curve Number
- Resistance Code (See Table)
- Other shaft styles available.

## Tapers

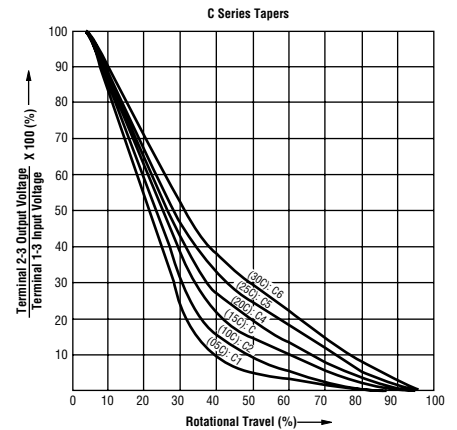
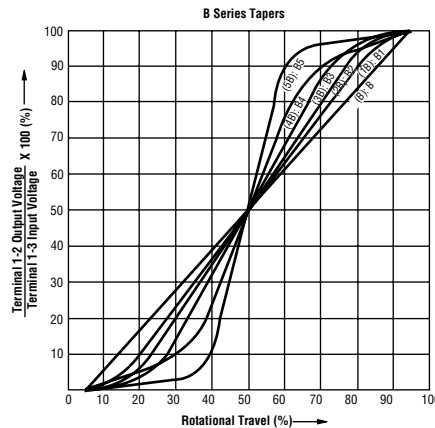
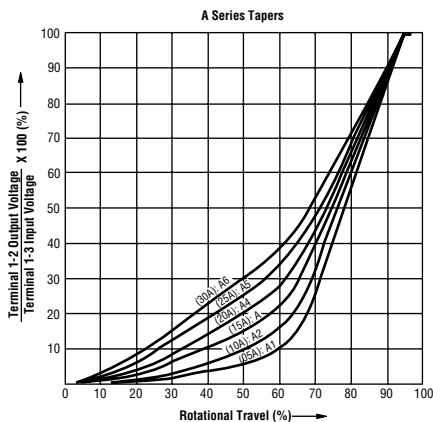

REV. 07/21

Specifications are subject to change without notice.

Users should verify actual device performance in their specific applications.

The products described herein and this document are subject to specific legal disclaimers as set forth on the last page of this document, and at [www.bourns.com/docs/legal/disclaimer.pdf](http://www.bourns.com/docs/legal/disclaimer.pdf).