

Features

- Carbon element
- Ganging up to 8 sections available
- Knurled and flatted shaft styles
- Audio taper option
- Tracking error within 3 dB
- RoHS compliant*

PTR90 Series - 9 mm Multi-Ganged Potentiometer w/Rotary Switch

Product Dimensions

PTR901

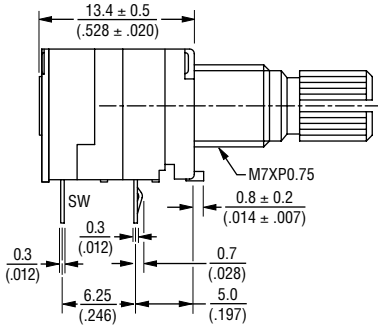

RECOMMENDED PCB LAYOUT

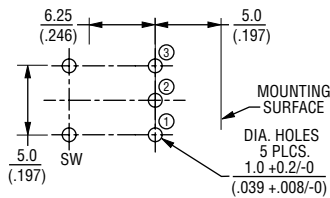

SCHEMATIC

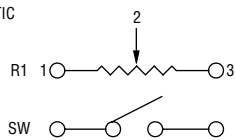

DIMENSIONS: $\frac{\text{MM}}{\text{(INCHES)}}$

Derating Curve

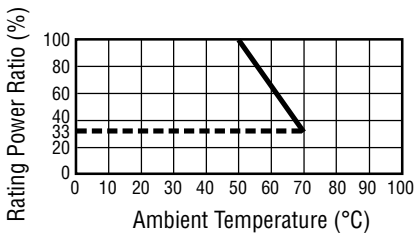

WARNING
Cancer and Reproductive Harm
www.P65Warnings.ca.gov

*RoHS Directive 2015/863, Mar 31, 2015 and Annex.
**Devices are tested using standard noise reduction filters. For optimum performance, designers should use noise reduction filters in their circuits. Specifications are subject to change without notice. Users should verify actual device performance in their specific applications. The products described herein and this document are subject to specific legal disclaimers as set forth on the last page of this document, and at www.bourns.com/docs/legal/disclaimer.pdf.

PTR902

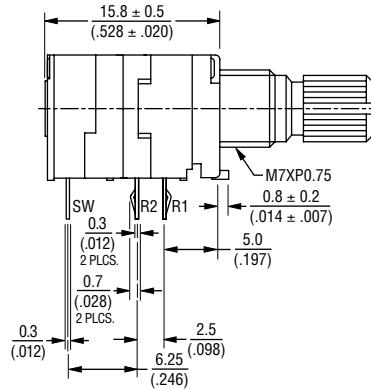

RECOMMENDED PCB LAYOUT

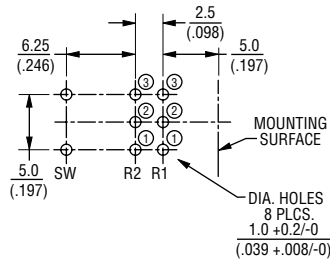

SCHEMATIC

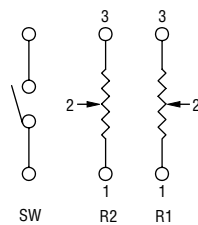

Standard Resistance Table

Resistance (Ohms)	Resistance Code
1,000	102
2,000	202
5,000	502
10,000	103
20,000	203
50,000	503
100,000	104
200,000	204
500,000	504
1,000,000	105



CAUTION

Do not store product in high temperature and humidity, direct sunlight and/or places where corrosive gases may be generated. Please use product within 6 months from the date of delivery and promptly after unpacking.

Additional Information

Click these links for more information:



Electrical Characteristics

Standard Resistance Range 1 K ohms to 1 M ohms
 Total Resistance Tolerance ±10 % or ±20 %
 Standard Tapers Linear & audio
 Maximum Operating Voltage 150 VAC, 20 VDC
 Rated Power
 Linear Taper 0.05 watts
 Audio Taper 0.025 watts
 Noise 100 mV max.
 Insulation Resistance @ 250 VDC 100 M ohms
 Dielectric Withstanding Voltage ..300 VAC
 End Resistance 20 ohms max.
 Tracking Error (-40 dB to 0 dB) ±3 dB

Environmental Characteristics

Operating Temperature -10 °C to +50 °C
 Rotational Life..... 15,000 cycles
 IP Rating..... IP 40

Switch Characteristics

Contact Resistance 50 milliohms max.
 Rated Power..... 3 A @ 16 VDC
 Detent Torque 400 g-cm max.
 Switch Activation Angle.....50 ° max.

Mechanical Characteristics

Mechanical Angle 300 ° ±10 °
 Running Torque 10 to 250 g-cm
 Stop Strength..... 4.0 kg-cm
 Shaft Push/Pull Strength 5.0 kgf min.
 Shaft Wobble 0.6 x L/20 mm p-p max.
 Mounting Torque..... 7.0 kg-cm min.
 Soldering Condition
 Manual Soldering
96.5 Sn/3.0 Ag/0.5 Cu solid wire
 or no-clean rosin cored wire
 270 °C max. for 3 seconds
 Wave Soldering
96.5 Sn/3.0 Ag/0.5 Cu solder
 with no-clean flux
 260 °C max. for 5 seconds
 Wash Process Not recommended
 Mounting HardwareOne flat washer
and one mounting nut supplied
per potentiometer

Applications

- Audio/TV sets
- Automotive sound systems
- Amplifiers/mixers/drum machines/synthesizers/DJ equipment
- Multimedia sound systems
- Portable electronics

PTR90 Series – 9 mm Multi-Ganged Potentiometer w/Rotary Switch BOURNS®

Product Dimensions

PTR904

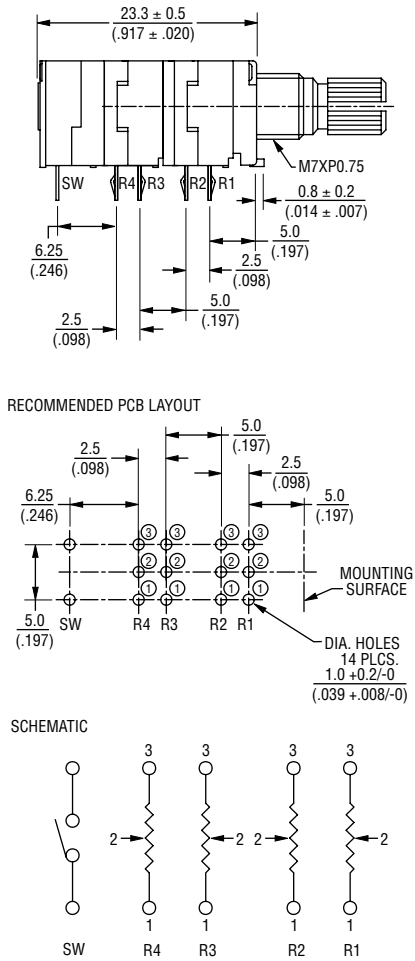

PTR906

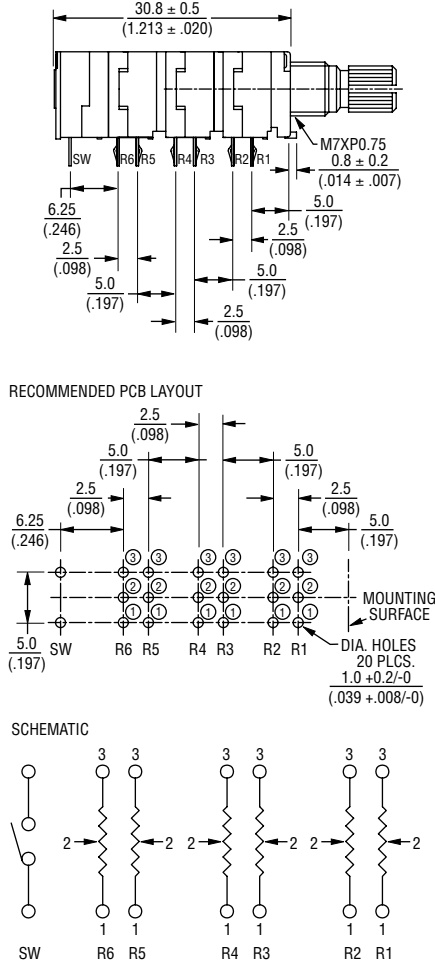

PTR908

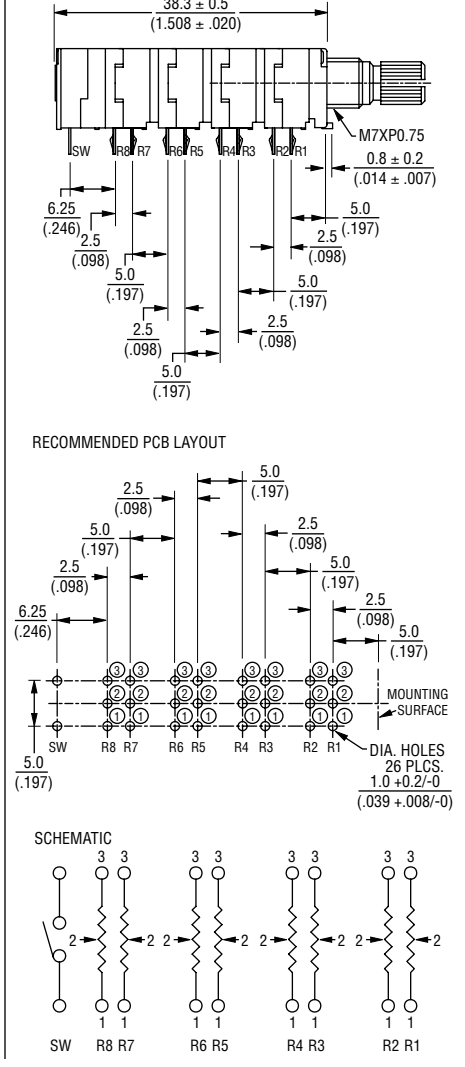

DIMENSIONS: $\frac{\text{MM}}{\text{(INCHES)}}$

BOURNS®

Asia-Pacific: Tel: +886-2 2562-4117 • Email: asiacus@bourns.com
EMEA: Tel: +36 88 885 877 • Email: eurocus@bourns.com
The Americas: Tel: +1-951 781-5500 • Email: americus@bourns.com
www.bourns.com

Specifications are subject to change without notice. Users should verify actual device performance in their specific applications. The products described herein and this document are subject to specific legal disclaimers as set forth on the last page of this document, and at www.bourns.com/docs/legal/disclaimer.pdf.

PTR90 Series – 9 mm Multi-Ganged Potentiometer w/Rotary Switch



Product Dimensions

SHAFT STYLE "K"

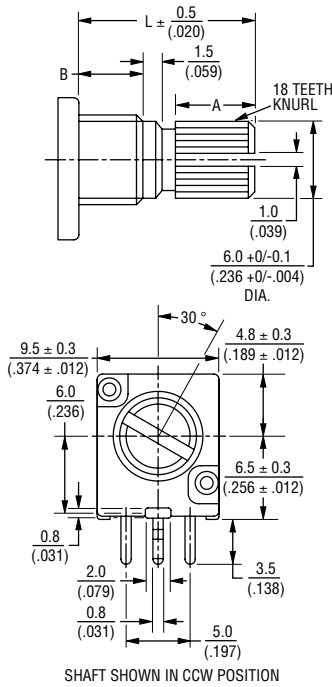

L	15 (.591)	20 (.787)	25 (.984)
B	5 (.197)	7 (.276)	10 (.394)
A	6 (.236)	10 (.394)	12 (.472)

DIMENSIONS: $\frac{\text{MM}}{\text{(INCHES)}}$

SHAFT STYLE "F"

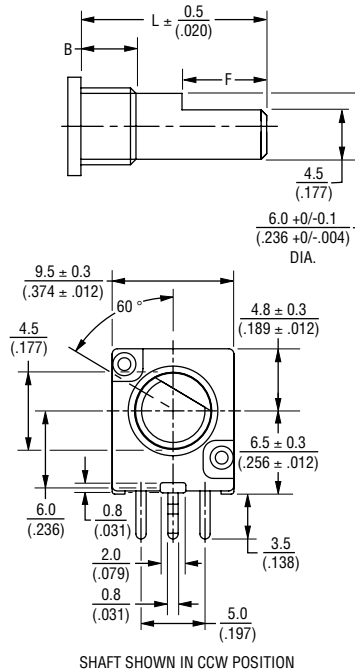

L	15 (.591)	20 (.787)	25 (.984)
B	5 (.197)	7 (.276)	10 (.394)
F	7 (.276)	12 (.472)	12 (.472)

DIMENSIONS: $\frac{\text{MM}}{\text{(INCHES)}}$

How To Order

PTR90 1 - 2 0 20 K - B 203

- Model
- PTR90 = With Rotary Switch
- No. of Sections
- 1 = 1 Section
 - 2 = 2 Sections
 - 3 = 3 Sections
 - 4 = 4 Sections
 - 5 = 5 Sections
 - 6 = 6 Sections
 - 8 = 8 Sections
- Pin Style
- 1 = PC Pins vertical/down facing and $\pm 10\%$ Total Resistance Tolerance
 - 2 = PC Pins vertical/down facing and $\pm 20\%$ Total Resistance Tolerance
- Center Detent Option
- 0 = No Detent
 - 2 = Center Detent
- Standard Shaft Length
- 15 = 15 mm
 - 20 = 20 mm
 - 25 = 25 mm
- Shaft Styles
- K = Knurled Type Shaft (Metal) 18 Toothed Serration Type
 - F = Flatted Metal Shaft
- Resistance Taper (See Taper Charts)
- Taper Series followed by Curve Number
- Resistance Code (See Table)
- Other shaft styles available.

Tapers

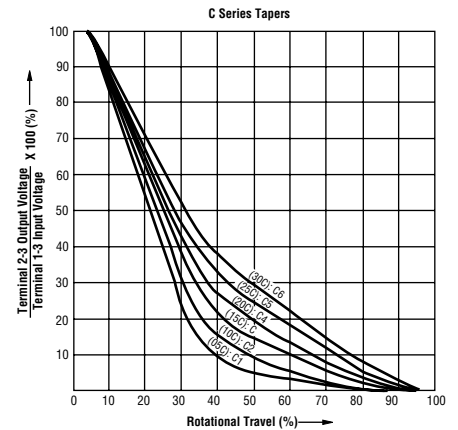
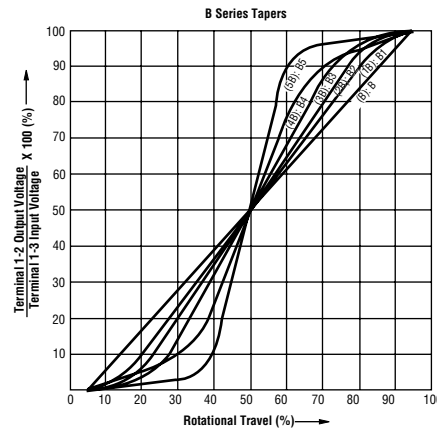
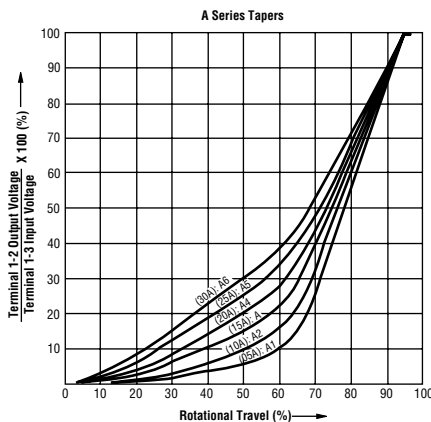

REV. 07/21

Specifications are subject to change without notice.

Users should verify actual device performance in their specific applications.

The products described herein and this document are subject to specific legal disclaimers as set forth on the last page of this document, and at www.bourns.com/docs/legal/disclaimer.pdf.