

# PTVA084007NF

## Thermally-Enhanced High Power RF LDMOS FET 370 W, 48 V, 755 – 805 MHz

### Description

The PTVA084007NF is a 370-watt ( $P_{3dB}$ ) LDMOS FET manufactured with Wolfspeed's 48-V LDMOS process. It is designed for use in multi-standard cellular power amplifier applications. It features a single-ended design and input and output matching that allow for use from 755 MHz to 805 MHz.



PTVA084007NF  
Package PG-HBSOF-4-2

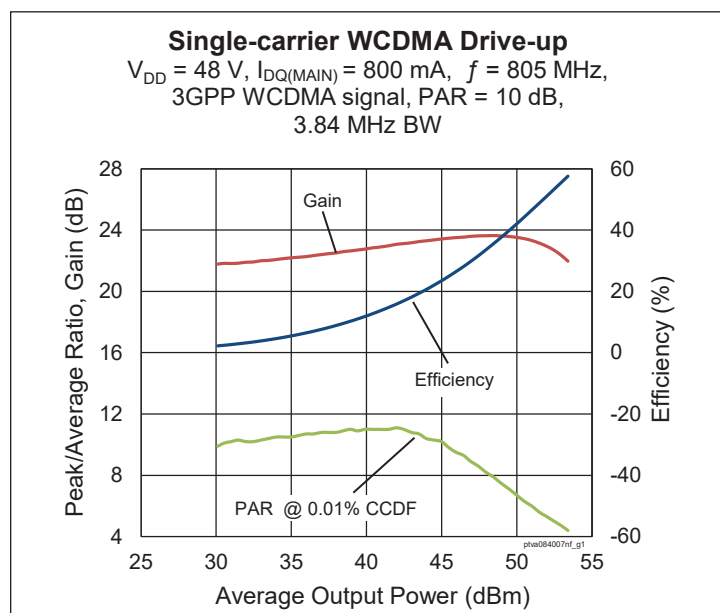

### Features

- Broadband internal input and output matching
- Target CW performance, 805 MHz, 48 V, single side
  - Output power at  $P_{3dB} = 370\text{ W}$
  - Efficiency = 64%
  - Gain = 20.8 dB
- Capable of handling 10:1 VSWR @ 48 V, 100 W (CW) output power
- Integrated ESD protection
- Human Body Model class 2 (per ANSI/ESDA/ JEDEC JS-001)
- Low thermal resistance
- Pb-free and RoHS compliant

### RF Characteristics

#### Single-carrier WCDMA Specifications (tested in Wolfspeed production test fixture)

$V_{DD} = 48\text{ V}$ ,  $I_{DQ} = 800\text{ mA}$ ,  $P_{OUT} = 80\text{ W avg}$ ,  $f_1 = 805\text{ MHz}$ , 3GPP signal, channel bandwidth = 3.84 MHz, peak/average = 10 dB @ 0.01% CCDF.

Characteristic	Symbol	Min	Typ	Max	Unit
Gain	$G_{ps}$	22	23.6	—	dB
Drain Efficiency	$\eta_D$	37	39	—	%
Adjacent Channel Power Ratio	ACPR	—	-31.6	-28.5	dBc
Output PAR @ 0.01% CCDF, 20 MHz	OPAR	6.4	7	—	dB

All published data at  $T_{CASE} = 25^\circ\text{C}$  unless otherwise indicated

ESD: Electrostatic discharge sensitive device—observe handling precautions!

## DC Characteristics

Characteristic	Conditions	Symbol	Min	Typ	Max	Unit
Drain-Source Breakdown Voltage	$V_{GS} = 0\text{ V}$ , $I_{DS} = 10\text{ mA}$	$V_{(BR)DSS}$	105	—	—	V
Drain Leakage Current	$V_{DS} = 48\text{ V}$ , $V_{GS} = 0\text{ V}$	$I_{DSS}$	—	—	1	$\mu\text{A}$
	$V_{DS} = 105\text{ V}$ , $V_{GS} = 0\text{ V}$	$I_{DSS}$	—	—	10	$\mu\text{A}$
Gate Leakage Current	$V_{GS} = 10\text{ V}$ , $V_{DS} = 0\text{ V}$	$I_{GSS}$	—	—	1	$\mu\text{A}$
On-State Resistance	$V_{GS} = 10\text{ V}$ , $V_{DS} = 0.1\text{ V}$	$R_{DS(on)}$	—	0.12	—	$\Omega$
Operating Gate Voltage	$V_{DS} = 48\text{ V}$ , $I_{DQ} = 0.7\text{ A}$	$V_{GS}$	3.07	3.67	4.27	V

## Maximum Ratings

Parameter	Symbol	Value	Unit
Drain-Source Voltage	$V_{DSS}$	105	V
Gate-Source Voltage	$V_{GS}$	-6 to +12	V
Operating Voltage	$V_{DD}$	0 to +55	V
Junction Temperature	$T_J$	225	$^{\circ}\text{C}$
Storage Temperature Range	$T_{STG}$	-65 to +150	$^{\circ}\text{C}$

## Thermal Characteristics

Parameter	Symbol	Value	Unit
Thermal Resistance ( $T_{CASE} = 70\text{ }^{\circ}\text{C}$ , 370 W CW)	$R_{\theta JC}$	0.21	$^{\circ}\text{C/W}$

## Ordering Information

Type and Version	Order Code	Package Description	Shipping
PTVA084007NF V1 R5	PTVA084007NF-V1-R5	PG-HBSOF-4-2, plastic package	Tape & Reel, 500 pcs

**Typical RF Performance** (data taken in production test fixture)

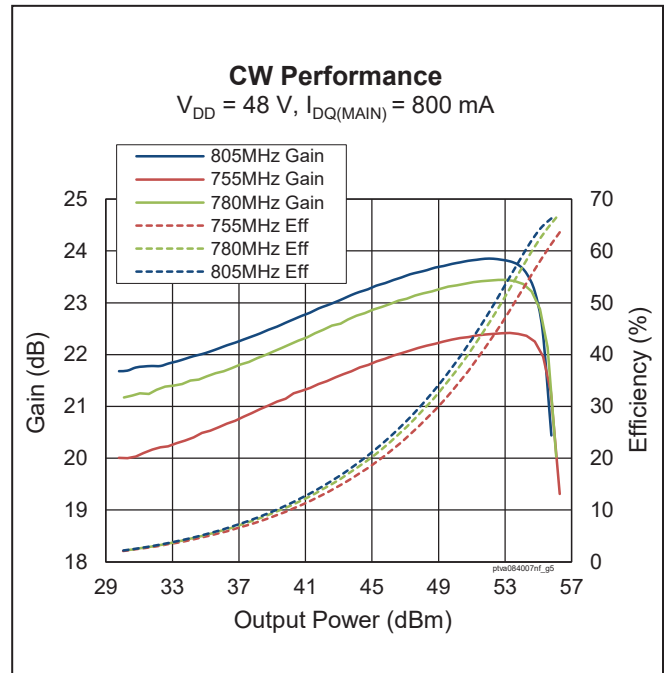
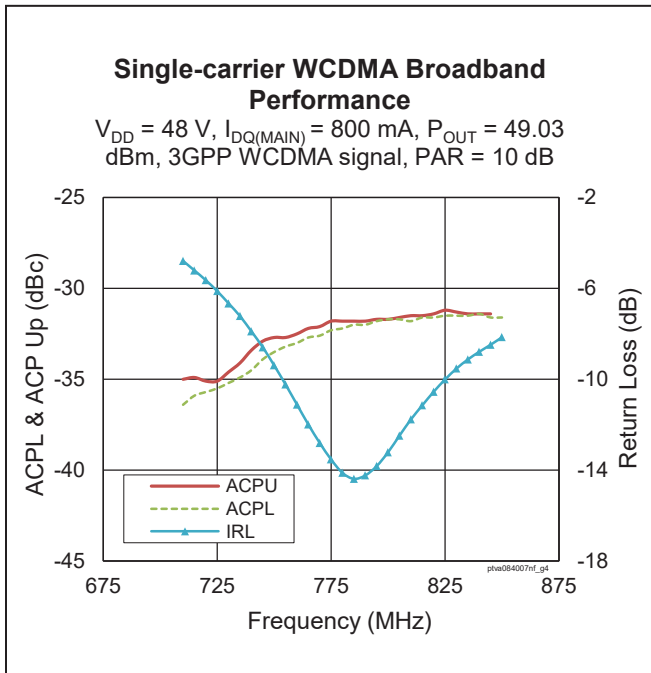
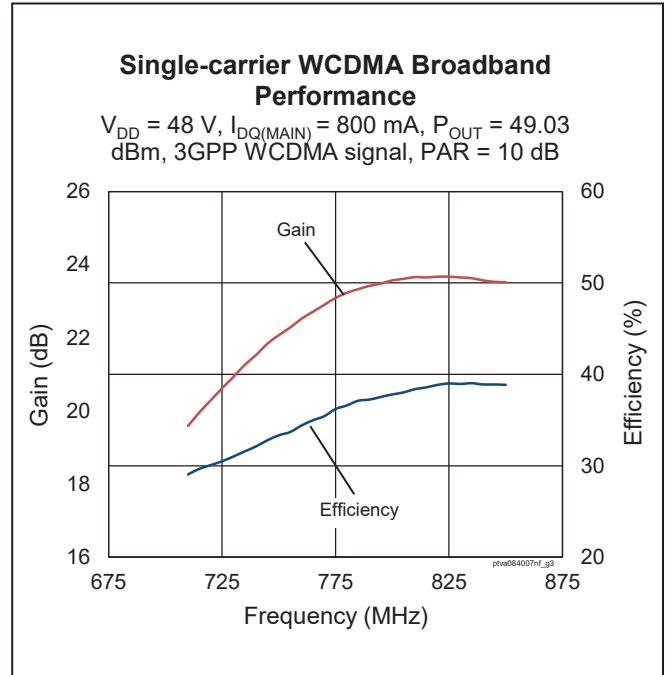
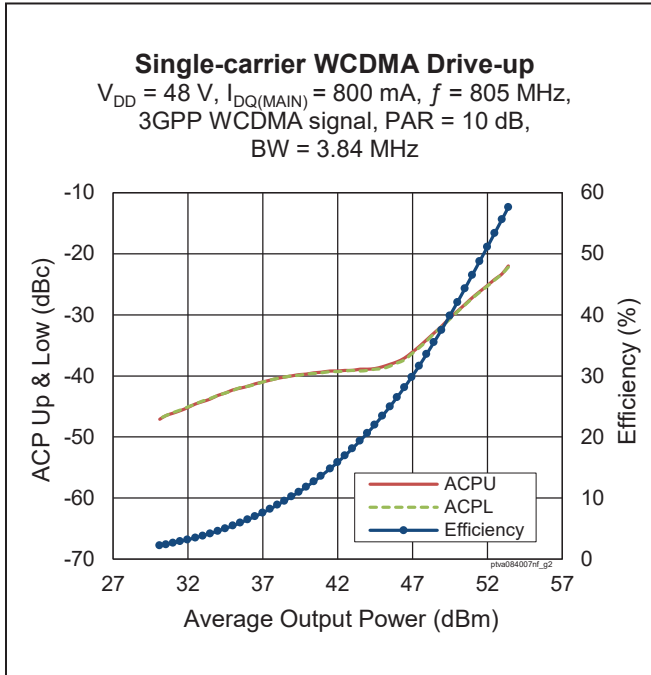

Typical RF Performance (cont.)

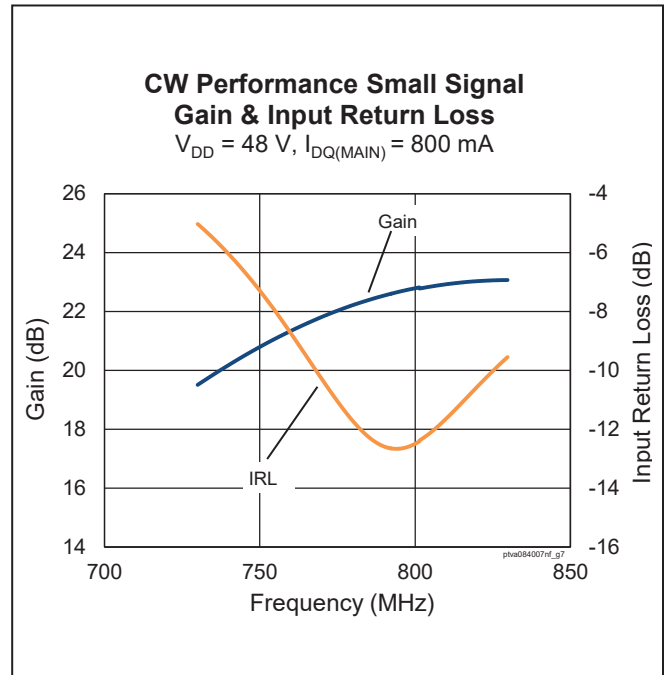
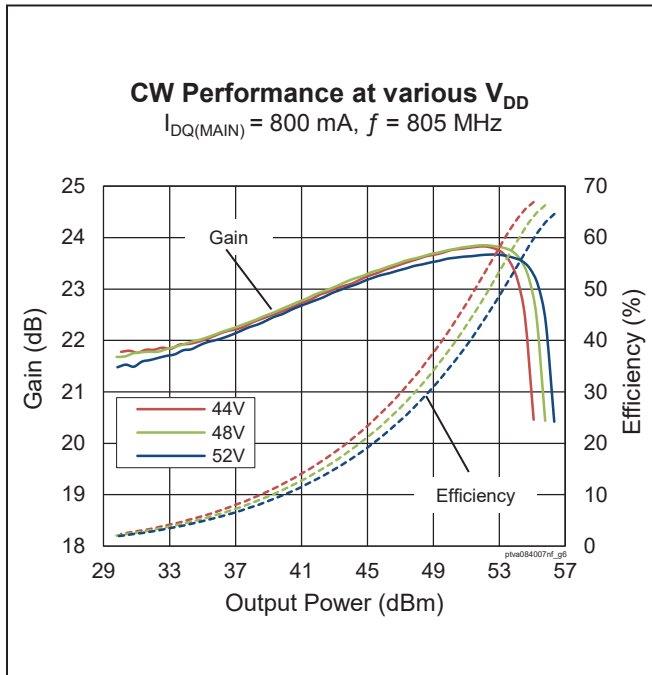

Load Pull Performance

Load Pull Performance – Pulsed CW signal: 160  $\mu\text{s}$ , 10% duty cycle, 48 V,  $I_{DQ} = 700 \text{ mA}$

		$P_{1dB}$									
		Max Output Power					Max Drain Efficiency				
Freq [MHz]	$Z_s$ [ $\Omega$ ]	$Z_l$ [ $\Omega$ ]	Gain [dB]	$P_{1dB}$ [dBm]	$P_{1dB}$ [W]	$\eta_D$ [%]	$Z_l$ [ $\Omega$ ]	Gain [dB]	$P_{1dB}$ [dBm]	$P_{1dB}$ [W]	$\eta_D$ [%]
758	1.97-j3.32	1.12-j0.53	21.7	57.00	501.2	58.6	2.02+j0.87	23.4	54.6	287.7	73.2
780	2.23-j3.76	1.09-j0.43	22.0	56.80	478.6	58.3	1.87+j0.89	23.8	54.5	281.2	72.0
803	3.01-j3.64	1.00-j0.42	22.0	56.78	476.4	57.6	1.83+j0.70	23.8	54.6	286.4	71.7

		$P_{3dB}$									
		Max Output Power					Max Drain Efficiency				
Freq [MHz]	$Z_s$ [ $\Omega$ ]	$Z_l$ [ $\Omega$ ]	Gain [dB]	$P_{3dB}$ [dBm]	$P_{3dB}$ [W]	$\eta_D$ [%]	$Z_l$ [ $\Omega$ ]	Gain [dB]	$P_{3dB}$ [dBm]	$P_{3dB}$ [W]	$\eta_D$ [%]
758	1.97-j3.32	1.14-j0.59	19.8	57.75	595.7	61.9	2.00+j0.40	21.3	55.9	388.2	73.8
780	2.23-j3.76	1.09-j0.46	20.0	57.56	570.2	60.9	1.96+j0.43	21.7	55.8	377.6	72.5
803	3.01-j3.64	1.03-j0.49	20.0	57.52	564.9	60.2	1.73+j0.62	21.7	55.3	338.1	72.0

### Reference Circuit, 758 – 803 MHz

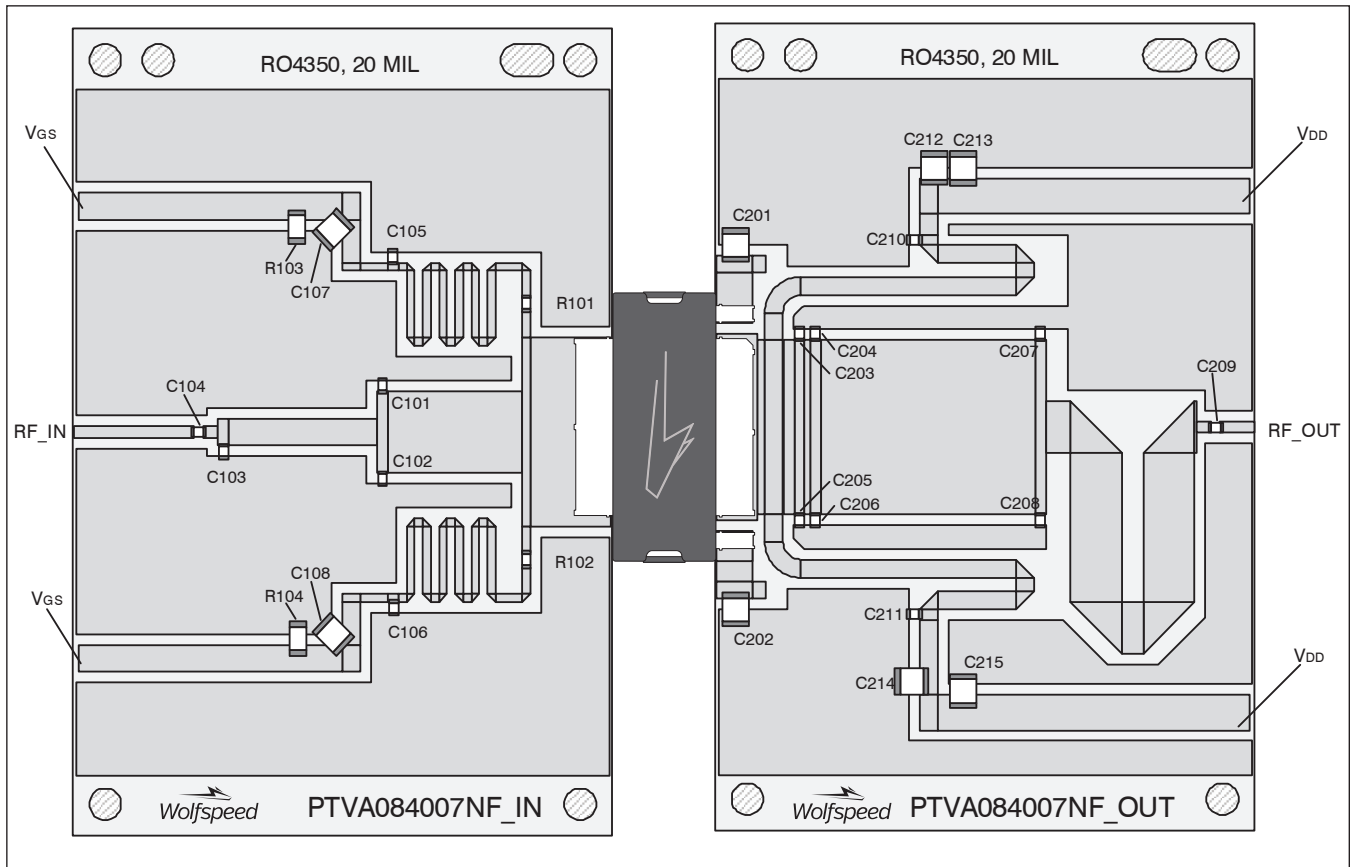

Reference circuit assembly diagram (not to scale)



**Reference Circuit** (cont.)

**Reference Circuit Assembly**

DUT	PTVA084007NF V1
Test Fixture Part No.	LTN/PTVA084007NF V1
PCB	Rogers 4350, 0.508 mm [0.020"] thick, 2 oz. copper, $\epsilon_r = 3.66$ , $f = 758 - 803$ MHz
Find Gerber files for this test fixture on the Wolfspeed Web site at <a href="http://www.wolfspeed.com/RF">www.wolfspeed.com/RF</a>	

**Components Information**

Component	Description	Manufacturer	P/N
<b>Input</b>			
C101, C103	Capacitor, 3.3 pF	ATC	ATC600F3R3CW250T
C102	Capacitor, 4.7 pF	ATC	ATC600F4R7CW250T
C104, C105, C106	Capacitor, 51 pF	ATC	ATC600F510JW250T
C107, C108	Capacitor, 10 $\mu$ F	Taiyo Yuden	UMK325C7106MM-T
R101, R102	Resistor, 10 ohms	Panasonic Electronic Components	ERJ-3GEYJ100V
R103, R104	Resistor, 1000 ohms	Panasonic Electronic Components	ERJ-8GEYJ102V
<b>Output</b>			
C201, C202, C212, C213, C214, C215	Capacitor, 10 $\mu$ F, 100 V	TDK Corporation	C5750X7S2A106M230KB
C203, C204, C205, C206	Capacitor, 8.2 pF	ATC	ATC600F8R2CW250T
C207, C208	Capacitor, 3.0 pF	ATC	ATC600F3R0CW250T
C209, C210, C211	Capacitor, 51 pF	ATC	ATC600F510JW250T

**Pinout Diagram** (top view)

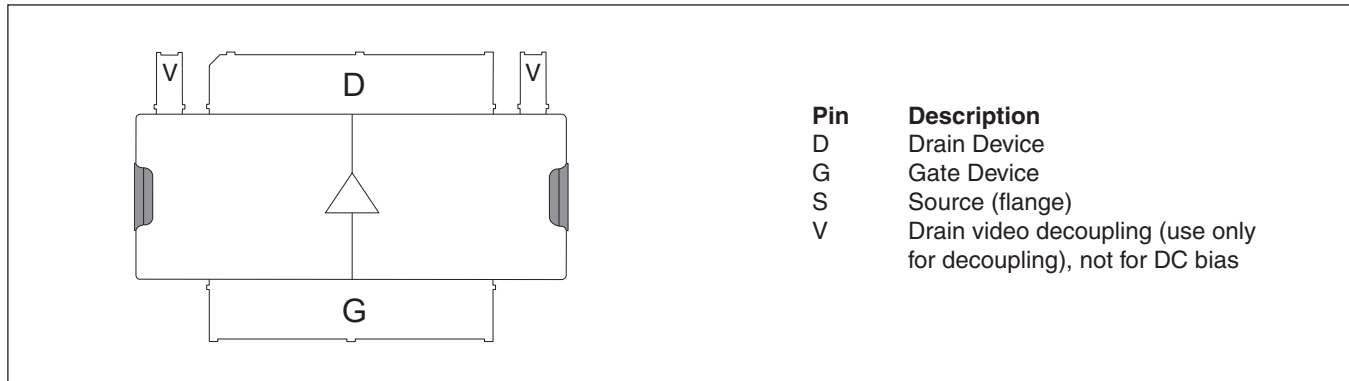

## Package Outline Specifications

### Package PG-HBSOF-4-2

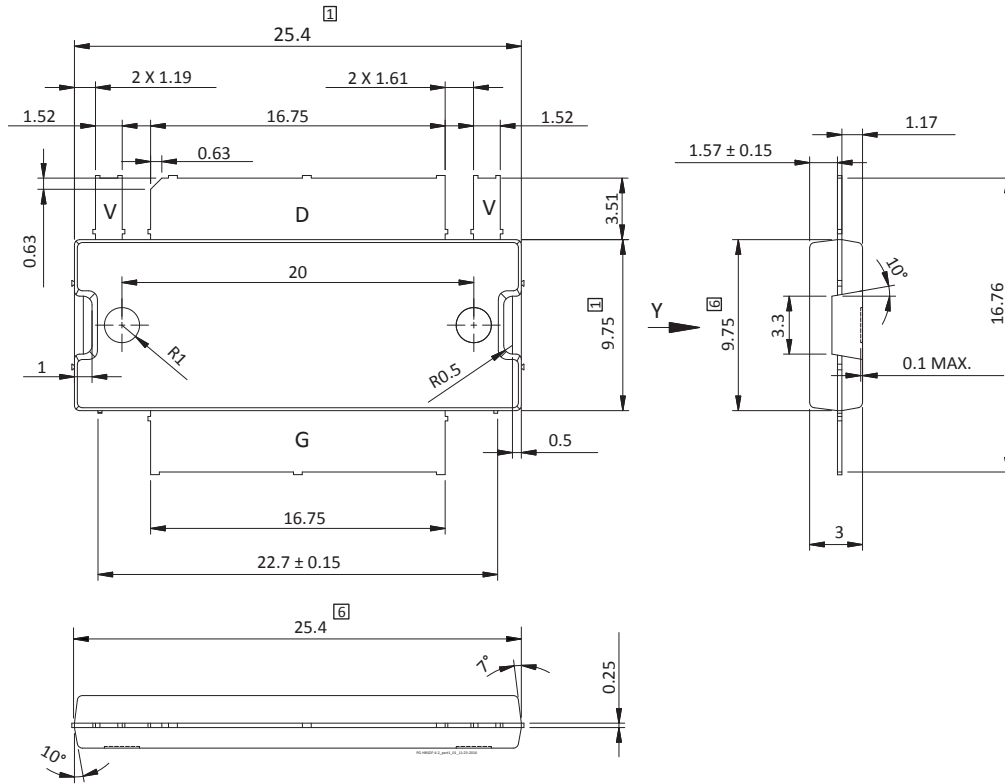

Diagram Notes – unless otherwise specified:

1. Mole/dam bar/metal protrusion of 0.30 mm max per side not included.
2. Metal protrusion are connected to source and shall not exceed 0.10 mm max.
3. Fillets and radii: all radii are 0.3 mm max.
4. Interpret dimensions and tolerances per ISO 8015.
5. Dimensions are mm.
6. Dose not include mold/dam bar/metal protrusion.
7. Exposed metal surface is tin-plated, may not be covered by mold compound.
8. All toleranceds ± 0.1 mm unless specified otherwise.
9. All metal surfaces are tin-plated, except area of cut.
10. Lead thickness: 0.25 mm.
11. Pins: D = drain; G = gate; S – source; V = drain video decoupling (use only for decoupling), not for DC bias.

## Package Outline Specifications

### Package PG-HBSOF-4-2

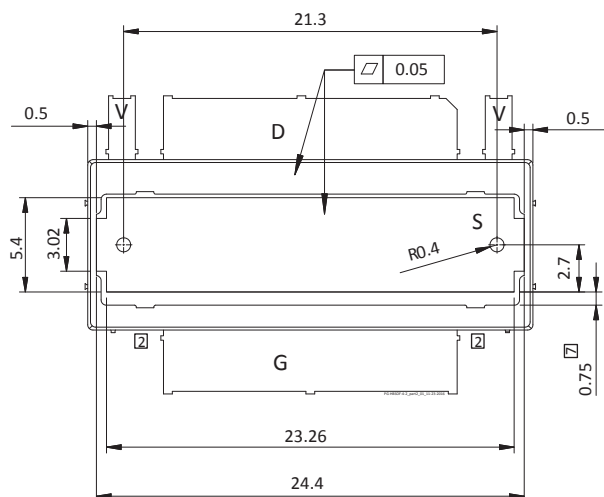

Diagram Notes – unless otherwise specified:

1. Molder/dam bar/metal protrusion of 0.30 mm max per side not included.
2. Metal protrusion are connected to source and shall not exceed 0.10 mm max.
3. Fillets and radii: all radii are 0.3 mm max.
4. Interpret dimensions and tolerances per ISO 8015.
5. Dimensions are mm.
6. Dose not include mold/dam bar/metal protrusion.
7. Exposed metal surface is tin-plated, may not be covered by mold compound.
8. All tolerances  $\pm 0.1$  mm unless specified otherwise.
9. All metal surfaces are tin-plated, except area of cut.
10. Lead thickness: 0.25 mm.
11. Pins: D = drain; G = gate; S = source; V = drain video decoupling (use only for decoupling), not for DC bias.