

# Trimmer Potentiometers



## Lead Sealed Type Multiturn PV36 Series

### PV36 Series

#### Features

1. Multiturn / Cermet / Sealed
2. Available in both top and side adjustment
3. Units can be pre-adjusted at clockwise, counter-clockwise or standard 50 % position
4. Standoffs allow thorough PC board washing
5. Chevron seal design
6. RoHS compliant\*
7. For trimmer applications/processing guidelines, [click here](#)

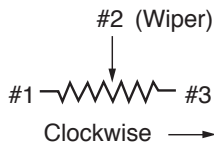

#### COMMON DIMENSIONS

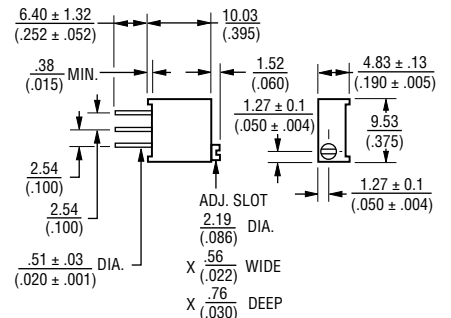

#### PV36W

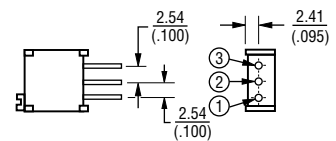

#### PV36Y

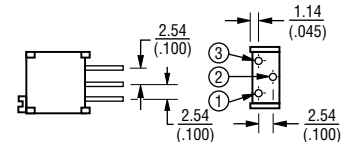

#### PV36X

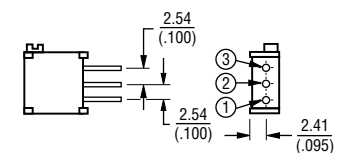

#### PV36Z

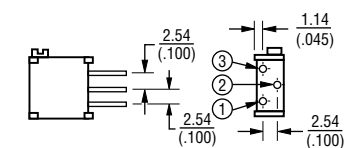

#### PV36P

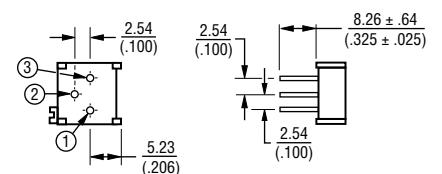

DIMENSIONS:  $\frac{\text{MM}}{\text{(INCHES)}}$   
 TOLERANCES:  $\pm \frac{0.25}{(.010)}$  EXCEPT WHERE NOTED



**WARNING**  
**Cancer and Reproductive Harm**  
[www.P65Warnings.ca.gov](http://www.P65Warnings.ca.gov)

\*RoHS Directive 2015/863, Mar. 31, 2015 and Annex.  
 Specifications are subject to change without notice. Users should verify actual device performance in their specific applications. The products described herein and this document are subject to specific legal disclaimers as set forth on the last page of this document, and at [www.bourns.com/docs/legal/disclaimer.pdf](http://www.bourns.com/docs/legal/disclaimer.pdf).

## Top Adjustment

Part Number	Power Rating (W)	Number of Turns (Effective Rotation Angle)	Total Resistance Value	TCR (ppm/°C)
PV36W100C01B00	0.5 (70 °C)	25	10 ohm ±10 %	±150
PV36W200C01B00	0.5 (70 °C)	25	20 ohm ±10 %	±150
PV36W500C01B00	0.5 (70 °C)	25	50 ohm ±10 %	±150
PV36W101C01B00	0.5 (70 °C)	25	100 ohm ±10 %	±150
PV36W201C01B00	0.5 (70 °C)	25	200 ohm ±10 %	±100
PV36W501C01B00	0.5 (70 °C)	25	500 ohm ±10 %	±100
PV36W102C01B00	0.5 (70 °C)	25	1k ohm ±10 %	±100
PV36W202C01B00	0.5 (70 °C)	25	2k ohm ±10 %	±100
PV36W502C01B00	0.5 (70 °C)	25	5k ohm ±10 %	±100
PV36W103C01B00	0.5 (70 °C)	25	10k ohm ±10 %	±100
PV36W203C01B00	0.5 (70 °C)	25	20k ohm ±10 %	±100
PV36W253C01B00	0.5 (70 °C)	25	25k ohm ±10 %	±100
PV36W503C01B00	0.5 (70 °C)	25	50k ohm ±10 %	±100
PV36W104C01B00	0.5 (70 °C)	25	100k ohm ±10 %	±100
PV36W204C01B00	0.5 (70 °C)	25	200k ohm ±10 %	±100
PV36W254C01B00	0.5 (70 °C)	25	250k ohm ±10 %	±100
PV36W504C01B00	0.5 (70 °C)	25	500k ohm ±10 %	±100
PV36W105C01B00	0.5 (70 °C)	25	1M ohm ±10 %	±100
PV36W205C01B00	0.5 (70 °C)	25	2M ohm ±10 %	±100

PV36Y100C01B00	0.5 (70 °C)	25	10 ohm ±10 %	±150
PV36Y200C01B00	0.5 (70 °C)	25	20 ohm ±10 %	±150
PV36Y500C01B00	0.5 (70 °C)	25	50 ohm ±10 %	±150
PV36Y101C01B00	0.5 (70 °C)	25	100 ohm ±10 %	±150
PV36Y201C01B00	0.5 (70 °C)	25	200 ohm ±10 %	±100
PV36Y501C01B00	0.5 (70 °C)	25	500 ohm ±10 %	±100
PV36Y102C01B00	0.5 (70 °C)	25	1k ohm ±10 %	±100
PV36Y202C01B00	0.5 (70 °C)	25	2k ohm ±10 %	±100
PV36Y502C01B00	0.5 (70 °C)	25	5k ohm ±10 %	±100
PV36Y103C01B00	0.5 (70 °C)	25	10k ohm ±10 %	±100
PV36Y203C01B00	0.5 (70 °C)	25	20k ohm ±10 %	±100
PV36Y253C01B00	0.5 (70 °C)	25	25k ohm ±10 %	±100
PV36Y503C01B00	0.5 (70 °C)	25	50k ohm ±10 %	±100
PV36Y104C01B00	0.5 (70 °C)	25	100k ohm ±10 %	±100
PV36Y204C01B00	0.5 (70 °C)	25	200k ohm ±10 %	±100
PV36Y254C01B00	0.5 (70 °C)	25	250k ohm ±10 %	±100
PV36Y504C01B00	0.5 (70 °C)	25	500k ohm ±10 %	±100
PV36Y105C01B00	0.5 (70 °C)	25	1M ohm ±10 %	±100
PV36Y205C01B00	0.5 (70 °C)	25	2M ohm ±10 %	±100

Operating Temperature Range: -55 to +125 °C

Soldering Method: Wave (Single and Dual)

**BOURNS®**

Specifications are subject to change without notice. Users should verify actual device performance in their specific applications. The products described herein and this document are subject to specific legal disclaimers as set forth on the last page of this document, and at [www.bourns.com/docs/legal/disclaimer.pdf](http://www.bourns.com/docs/legal/disclaimer.pdf).

## Side Adjustment

Part Number	Power Rating (W)	Number of Turns (Effective Rotation Angle)	Total Resistance Value	TCR (ppm/°C)
PV36X100C01B00	0.5 (70 °C)	25	10 ohm ±10 %	±150
PV36X200C01B00	0.5 (70 °C)	25	20 ohm ±10 %	±150
PV36X500C01B00	0.5 (70 °C)	25	50 ohm ±10 %	±150
PV36X101C01B00	0.5 (70 °C)	25	100 ohm ±10 %	±150
PV36X201C01B00	0.5 (70 °C)	25	200 ohm ±10 %	±100
PV36X501C01B00	0.5 (70 °C)	25	500 ohm ±10 %	±100
PV36X102C01B00	0.5 (70 °C)	25	1k ohm ±10 %	±100
PV36X202C01B00	0.5 (70 °C)	25	2k ohm ±10 %	±100
PV36X502C01B00	0.5 (70 °C)	25	5k ohm ±10 %	±100
PV36X103C01B00	0.5 (70 °C)	25	10k ohm ±10 %	±100
PV36X203C01B00	0.5 (70 °C)	25	20k ohm ±10 %	±100
PV36X253C01B00	0.5 (70 °C)	25	25k ohm ±10 %	±100
PV36X503C01B00	0.5 (70 °C)	25	50k ohm ±10 %	±100
PV36X104C01B00	0.5 (70 °C)	25	100k ohm ±10 %	±100
PV36X204C01B00	0.5 (70 °C)	25	200k ohm ±10 %	±100
PV36X254C01B00	0.5 (70 °C)	25	250k ohm ±10 %	±100
PV36X504C01B00	0.5 (70 °C)	25	500k ohm ±10 %	±100
PV36X105C01B00	0.5 (70 °C)	25	1M ohm ±10 %	±100
PV36X205C01B00	0.5 (70 °C)	25	2M ohm ±10 %	±100

PV36P100C01B00	0.5 (70 °C)	25	10 ohm ±10 %	±150
PV36P200C01B00	0.5 (70 °C)	25	20 ohm ±10 %	±150
PV36P500C01B00	0.5 (70 °C)	25	50 ohm ±10 %	±150
PV36P101C01B00	0.5 (70 °C)	25	100 ohm ±10 %	±150
PV36P201C01B00	0.5 (70 °C)	25	200 ohm ±10 %	±100
PV36P501C01B00	0.5 (70 °C)	25	500 ohm ±10 %	±100
PV36P102C01B00	0.5 (70 °C)	25	1k ohm ±10 %	±100
PV36P202C01B00	0.5 (70 °C)	25	2k ohm ±10 %	±100
PV36P502C01B00	0.5 (70 °C)	25	5k ohm ±10 %	±100
PV36P103C01B00	0.5 (70 °C)	25	10k ohm ±10 %	±100
PV36P203C01B00	0.5 (70 °C)	25	20k ohm ±10 %	±100
PV36P253C01B00	0.5 (70 °C)	25	25k ohm ±10 %	±100
PV36P503C01B00	0.5 (70 °C)	25	50k ohm ±10 %	±100
PV36P104C01B00	0.5 (70 °C)	25	100k ohm ±10 %	±100
PV36P204C01B00	0.5 (70 °C)	25	200k ohm ±10 %	±100
PV36P254C01B00	0.5 (70 °C)	25	250k ohm ±10 %	±100
PV36P504C01B00	0.5 (70 °C)	25	500k ohm ±10 %	±100
PV36P105C01B00	0.5 (70 °C)	25	1M ohm ±10 %	±100
PV36P205C01B00	0.5 (70 °C)	25	2M ohm ±10 %	±100

PV36Z100C01B00	0.5 (70 °C)	25	10 ohm ±10 %	±150
PV36Z200C01B00	0.5 (70 °C)	25	20 ohm ±10 %	±150
PV36Z500C01B00	0.5 (70 °C)	25	50 ohm ±10 %	±150
PV36Z101C01B00	0.5 (70 °C)	25	100 ohm ±10 %	±150
PV36Z201C01B00	0.5 (70 °C)	25	200 ohm ±10 %	±100
PV36Z501C01B00	0.5 (70 °C)	25	500 ohm ±10 %	±100
PV36Z102C01B00	0.5 (70 °C)	25	1k ohm ±10 %	±100
PV36Z202C01B00	0.5 (70 °C)	25	2k ohm ±10 %	±100
PV36Z502C01B00	0.5 (70 °C)	25	5k ohm ±10 %	±100
PV36Z103C01B00	0.5 (70 °C)	25	10k ohm ±10 %	±100
PV36Z203C01B00	0.5 (70 °C)	25	20k ohm ±10 %	±100
PV36Z253C01B00	0.5 (70 °C)	25	25k ohm ±10 %	±100
PV36Z503C01B00	0.5 (70 °C)	25	50k ohm ±10 %	±100
PV36Z104C01B00	0.5 (70 °C)	25	100k ohm ±10 %	±100
PV36Z204C01B00	0.5 (70 °C)	25	200k ohm ±10 %	±100
PV36Z254C01B00	0.5 (70 °C)	25	250k ohm ±10 %	±100
PV36Z504C01B00	0.5 (70 °C)	25	500k ohm ±10 %	±100
PV36Z105C01B00	0.5 (70 °C)	25	1M ohm ±10 %	±100
PV36Z205C01B00	0.5 (70 °C)	25	2M ohm ±10 %	±100

Operating Temperature Range: -55 to +125 °C

Soldering Method: Wave (Single and Dual)

**BOURNS®**

Specifications are subject to change without notice. Users should verify actual device performance in their specific applications. The products described herein and this document are subject to specific legal disclaimers as set forth on the last page of this document, and at [www.bourns.com/docs/legal/disclaimer.pdf](http://www.bourns.com/docs/legal/disclaimer.pdf).

### Standard Mounting Holes

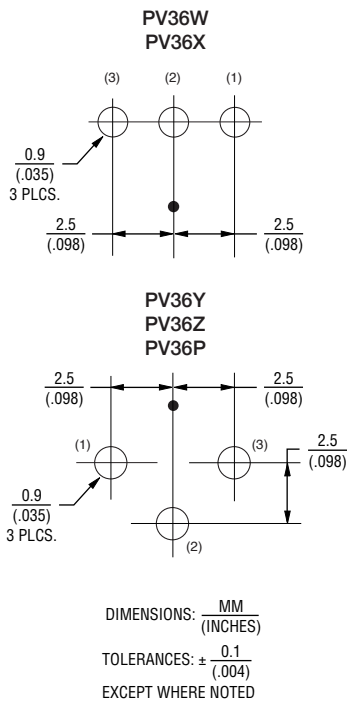

### Characteristics

Temperature Cycle	$\Delta TR$ : $\pm 2\%$ $\Delta V.S.S.$ : $\pm 1\%$
Humidity	$\Delta TR$ : $\pm 2\%$ IR : 100M ohm min.
Vibration (20G)	$\Delta TR$ : $\pm 1\%$ $\Delta V.S.S.$ : $\pm 1\%$
Shock (100G)	$\Delta TR$ : $\pm 1\%$ $\Delta V.S.S.$ : $\pm 1\%$
Temperature Load Life	$\Delta TR$ : $\pm 3\%$ $\Delta V.S.S.$ : $\pm 1\%$
Low Temperature Exposure	$\Delta TR$ : $\pm 2\%$ $\Delta V.S.S.$ : $\pm 1\%$
High Temperature Exposure	$\Delta TR$ : $\pm 3\%$ $\Delta V.S.S.$ : $\pm 1\%$
Rotational Life	$\Delta TR$ : RV 1k ohm, RU500k ohm ... $\pm 5\%$ 1k ohmFRF500k ohm ... $\pm 3\%$ (200 cycles)

$\Delta TR$  : Total Resistance Change  
 $\Delta V.S.S.$  : Voltage Setting Stability  
IR : Insulation Resistance  
R : Standard Total Resistance

### Part Numbering

**PV 36 W 103 C01 B00**

Product ID \_\_\_\_\_  
PV = Trimming Potentiometer

Series \_\_\_\_\_  
36 = Lead Sealed 10 mm Square, 25-Turns

Adjustment Direction/Lead Type \_\_\_\_\_  
W = Top, Inline    Y = Top, Triangle  
X = Side, Inline    Z = Top, Triangle  
P = Side, Triangle

Total Resistance \_\_\_\_\_

Expressed by three figures.  
The first and second figures are significant digits;  
the third figure expresses the number of zeros  
that follow.

Resistance (Ohms)	Resistance Code
<b>10</b>	<b>100</b>
<b>20</b>	<b>200</b>
<b>50</b>	<b>500</b>
<b>100</b>	<b>101</b>
<b>200</b>	<b>201</b>
<b>500</b>	<b>501</b>
<b>1,000</b>	<b>102</b>
<b>2,000</b>	<b>202</b>
<b>5,000</b>	<b>502</b>
<b>10,000</b>	<b>103</b>
<b>20,000</b>	<b>203</b>
<b>25,000</b>	<b>253</b>
<b>50,000</b>	<b>503</b>
<b>100,000</b>	<b>104</b>
<b>200,000</b>	<b>204</b>
<b>250,000</b>	<b>254</b>
<b>500,000</b>	<b>504</b>
<b>1,000,000</b>	<b>105</b>
<b>2,000,000</b>	<b>205</b>

Popular values listed in boldface. Special resistances available.

Individual Specification \_\_\_\_\_  
C01 = Standard Type

Packaging \_\_\_\_\_  
B00 = Tube (50 pcs. per tube)

### Typical Part Marking

#### 3-Digit Date Code and Manufacturing Code

- First digit indicates year of manufacture;
- Last two digits indicate week of manufacture;
- 4th digit is suffix for manufacturing location:  
C = Costa Rica

Example:

604C = Manufactured in 2016, week 4, Costa Rica

#### Resistance Code

- Resistance code marking as shown in the Part Numbering Resistance Table.

# BOURNS®

Specifications are subject to change without notice. Users should verify actual device performance in their specific applications. The products described herein and this document are subject to specific legal disclaimers as set forth on the last page of this document, and at [www.bourns.com/docs/legal/disclaimer.pdf](http://www.bourns.com/docs/legal/disclaimer.pdf).