

Monitoring Relays

3-Phase Active power direction

Types DWB03, PWB03

CARLO GAVAZZI



DWB03



PWB03

- TRMS active power relays for three phase balanced applications
- Measuring if active power is within set limits
- Measure their own power supply
- Measuring ranges: 5A, 10A, MI current transformers
- Power ON delay 1 to 30 s knob selectable
- Separately adjustable upper/lower level on relative scale
- Programmable latching or inhibit at set level
- Automatic and manual start and stop of the system
- Output: 8 A SPDT relay N.D. or N.E. selectable
- For mounting on DIN-rail in accordance with DIN/EN 50 022 (DWB03) or plug-in module (PWB03)
- 45 mm Euronorm housing (DWB03) or 36 mm plug-in module (PWB03)
- LED indication for relay, alarm and power supply ON

Product Description

DWB03 and PWB03 are precise TRMS active power monitoring relays for 3-phase balanced systems. They can be used for monitoring the actual load of asynchronous motors and other symmetrical loads, as well as to see if the power flows in the correct direction. Start/stop input allows to

use a manual switch to start and stop the system, without the need of an auxiliary device. The advantage of using the latch function is that the alarm status can be kept even after the end of the alarm condition. The LED's indicate the state of the alarm and the output relay.

Ordering key **DWB 03 C M48 10A**

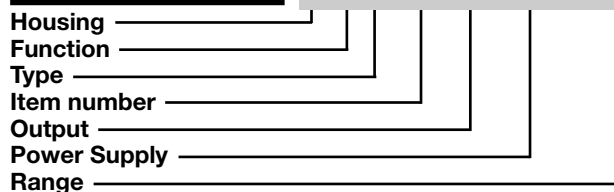

Type Selection

Mounting	Output	Supply: 208 to 240 VAC	Supply: 380 to 415 VAC	Supply: 380 to 480 VAC	Supply: 600 to 690 VAC
DIN-rail	SPDT	DWB 03 C M23 10A	PWB 03 C M48 10A	DWB 03 C M48 10A	DWB03 C M69 10A
Plug-in	SPDT	PWB 03 C M23 10A			

Input Specifications

Input	Supply	Standard CT (examples)	5 to 50 A	60 A
Voltage (own power supply): 3 - phase	DWB03: L1, L2, L3 PWB03: 5, 6, 7	TADK2 50 A/5 A CTD1 150 A/5 A CTD4 400 A/5 A TAD12 1000 A/5 A TACO200 6000 A/5 A	15 to 150 A	180 A
1- phase	M23: 208 to 240 VAC ± 15% DWB03CM48: 380 to 480 VAC ± 15% PWB03CM48: 380 to 415 VAC ± 15% DWB03CM69: 600 to 690 VAC ± 15% DWB03CM23: L1, L2 PWB03CM23: 5, 6	MI CT ranges MI 100 MI 500	100 to 1000 A 600 to 6000 A	1200 A 7200 A
Current:	DWB03: 5A, 10A: I1, I2 MI...:U1, U2 PWB03: 5A, 10A: 11, 10 MI...: 9, 8		10 to 100 A 50 to 500 A	250 AAC 750 AAC
Measuring ranges Active power	Upper level -100 to 100 % Lower level -100 to 100 % AACrms Max. curr. (30s)			
Direct input:	0.5 to 5A 1 to 10A			
Contact input	DWB03 PWB03 Disabled Enabled Pulse width			Terminals Z1, U2 Terminals 2, 9 > 10 kΩ < 500 Ω > 500 ms
Hysteresis				~ 2% of set value - fixed

Output Specifications

Output	SPDT relay
Rated insulation voltage	250 VAC
Contact ratings (AgSnO₂)	μ
Resistive loads AC 1	8 A @ 250 VAC
DC 12	5 A @ 24 VDC
Small inductive loads AC 15	2.5 A @ 250 VAC
DC 13	2.5 A @ 24 VDC
Mechanical life	≥ 30 x 10 ⁶ operations
Electrical life	≥ 10 ⁵ operations (at 8 A, 250 V, cos φ = 1)
Operating frequency	≤ 7200 operations/h
Dielectric strength	
Dielectric voltage	≥ 2 kVAC (rms)
Rated impulse withstand volt.	4 kV (1.2/50 μs)

Supply Specifications

Power supply	Overvoltage cat. III (IEC 60664, IEC 60038)
Rated operational voltage	
Through terminals:	
DWB03:	L1, L2, L3
PWB03:	5, 6, 7
M23	177 to 276 VAC 45 to 65 Hz
DWB03CM48	323 to 552 VAC 45 to 65 Hz
PWB03CM48	323 to 477 VAC 45 to 65 Hz
DWB03CM69	510 to 793 VAC 45 to 65 Hz
Dielectric voltage supply to output	4 kV
Rated operational power	
M23	9 VA @ 230 V, 50 Hz
M48	13 VA @ 400 V, 50 Hz
M69	21 VA @ 600 V, 50 Hz
Supplied by	L1 and L2

General Specifications

Power ON delay	1 to 30 s ± 0.5 s
Reaction time	(input signal variation from -20% to +20% or from +20% to -20% of set value)
Alarm ON delay	< 250 ms
Alarm OFF delay	< 250 ms
Accuracy	(15 min warm-up time)
Temperature drift	± 1000 ppm/°C
Delay ON alarm	± 10% on set value ± 50 ms
Repeatability	± 0.5% on full-scale
Indication for	
Power supply ON	LED, green
Alarm ON	LED, red (flashing 2 Hz during delay time)
Output relay ON	LED, yellow
Environment	
Degree of protection	IP 20
Pollution degree	3 (DWB03), 2 (PWB03)
Operating temperature	
@ Max. voltage, 50 Hz	-20 to +60°C, R.H. < 95%
@ Max. voltage, 60 Hz	-20 to +50°C, R.H. < 95%
Storage temperature	-30 to +80°C, R.H. < 95%
Housing	
Dimensions	DWB03 45 x 80 x 99.5 mm PWB03 36 x 80 x 94 mm
Material	PA66 or Noryl
Weight	Approx. 250 g
Screw terminals	
Tightening torque	Max. 0.5 Nm acc. to IEC 60947
Product standard	EN 60255-6
Approvals	UL
CE Marking	L.V. Directive 2006/95/EC EMC Directive 2004/108/EC
EMC	
Immunity	According to EN 60255-26 According to EN 61000-6-2
Emissions	According to EN 60255-26 According to EN 61000-6-3

Mode of Operation

DWB03 and PWB03 measure the active power of a 3-phase balanced system. The relay has an adjustable power ON delay in order to avoid undesired overload detection during motor start.

Example 1

Latching mode, relay NE.
In this application DWB03 or PWB03 is connected to an external current metering transformer, type MI..., (connected between U1 & U2) as well as to a 3-phase asynchronous motor. The relay is

energized as soon as the power supply is applied. After the power ON delay, the unit starts to measure power. If it is within the setpoints, the relay is energized, and the yellow LED is ON. As soon as the power drops below the lower setpoint or raises above the upper setpoint the output relay releases after the set time has expired. To restart the measurement, connect Z1 and U1 (2 and 9) or interrupt the power supply for at least 1 s.

Example 2

Latching mode, relay NE.
Monitoring the correct power flow of a generator.
DWB03 and PWB03 react as described in the previous example 1. Setting underpower setpoint at 0 allows to protect the generator both from overload and from becoming a motor (i.e.; supplied by other devices in the system) allowing, for example, to disconnect it in such an event.

Example 3

Start/stop mode, relay NE.
In this application DWB03 or PWB03 are directly connected to a 3-phase asynchronous motor. The relay is energized as soon as the power supply is applied and the start/stop contact is closed. After the power ON delay, the unit starts to measure the active power. If it is within the setpoints the relay is energized. As soon as the power drops below the lower setpoint or raises above the upper setpoint the out-

Mode of Operation (cont.)

put relay releases and the red LED turns on after the set time has expired. When the start/stop contact is opened the relay is immediately de-energized. To restart the system just connect the start/stop contact.

Note 1: to use the start/stop function the output relay has to command a contactor in series to the load (see last two wiring diagrams).

Note 2 (3-phase voltage): connect the 3-phase power supply to the terminals L1, L2 and L3 (DWB03) - 5, 6 and 7 (PWB03) taking care of the sequence.

Function/Range/Level/Time Setting

Select the desired function setting the DIP-switches 1 to 4 as shown on the right. Adjust the input range setting the DIP-switches 5 and 6. To access the DIP-switches open the plastic cover using a screwdriver as shown below. If DIP switch 3 is set to ON (start/stop) the position of DIP switch 4 does not affect the products' working mode.

Center knobs:
Setting of upper and lower-level from -100 to 100% of nominal power.

Lower left knob:
Setting of delay on absolute scale: 0.1 to 30 s.

Lower right knob:
Setting of power ON delay on absolute scale: 1 to 30 s.

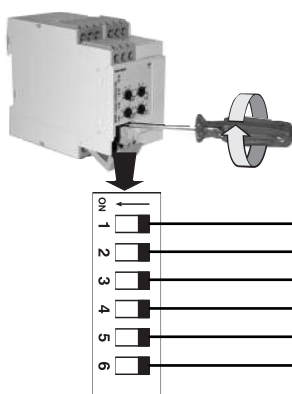

Input current range (terminals I1, I2 or 10, 11)
ON: 10A
OFF: 5A/MI

Relay status
ON: Relay de-energized in normal condition
OFF: Relay energized in normal condition

Working mode
ON: Contact input for start/stop functions
OFF: Contact input for latch/inhibit functions

Contact input (SW3 OFF)
ON: Latch function enable
OFF: Inhibit function enable

Measuring range

SW5	ON	ON	OFF	OFF
SW6	ON	OFF	ON	OFF
M23	208 VAC	220 VAC	230 VAC	240 VAC
M48	380 VAC	400 VAC	415 VAC	480 VAC DWB03 only
M69	600 VAC	690 VAC	600 VAC	690 VAC

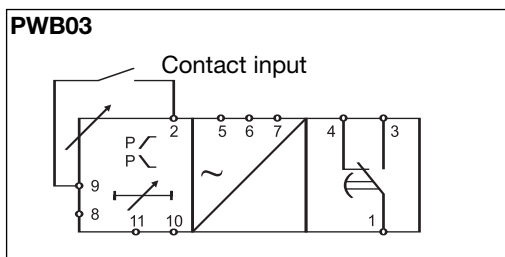
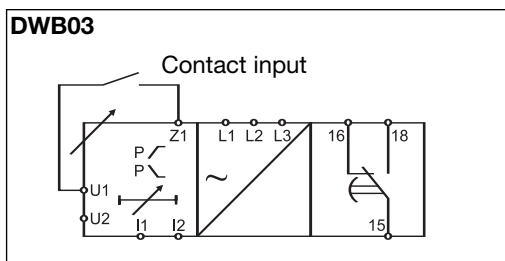

Notes

- DIP-switch 3 set ON enables the start/stop function that is managed by the closing-opening of the contact input.
- DIP-switch 3 set OFF enables the input contact for the latch/inhibit functions: the selection between these is allowed by DIP switch 4.

The following table shows as the input contact manages the mode of operation:

Contact input working mode

	CLOSED	OPEN
LATCH	NOT ACTIVE	ACTIVE
INHIBIT	ACTIVE	NOT ACTIVE
START/STOP	START	STOP

Operation Diagrams

Latch function - NE relay

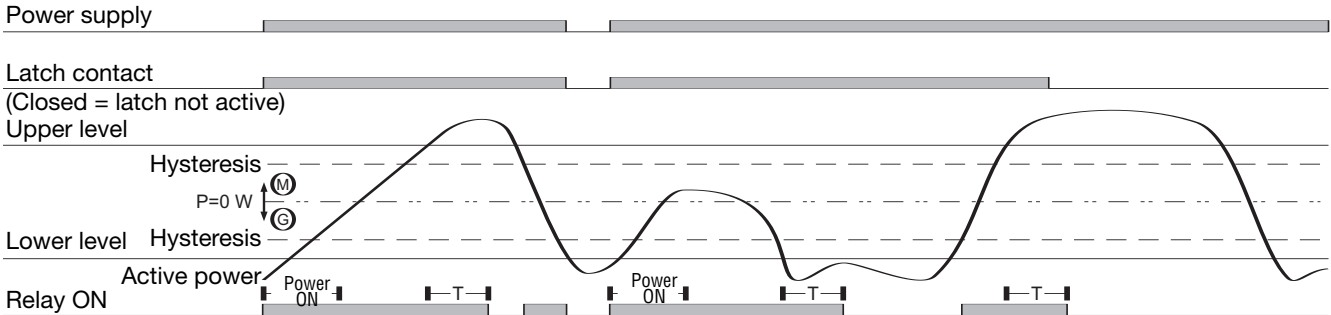

Inhibit function - ND relay

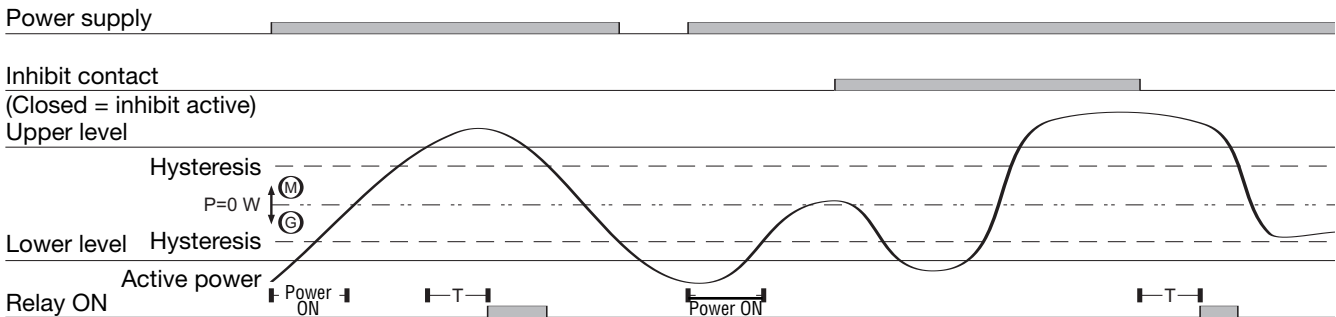

Start and stop function - NE relay

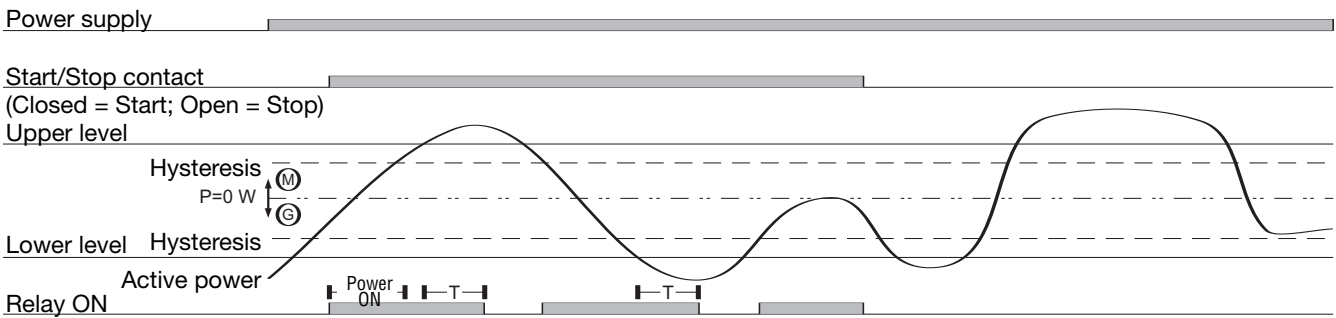

Wiring Diagrams

DWB03 - Direct connection

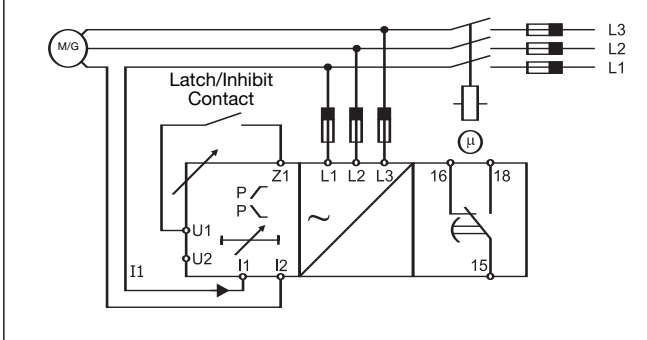

PWB03 - Direct connection

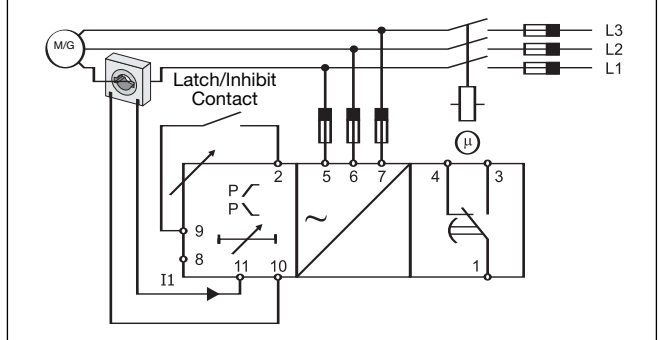

Wiring Diagrams (cont.)

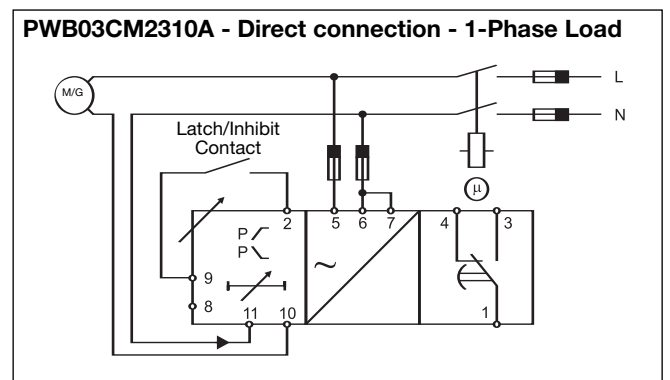
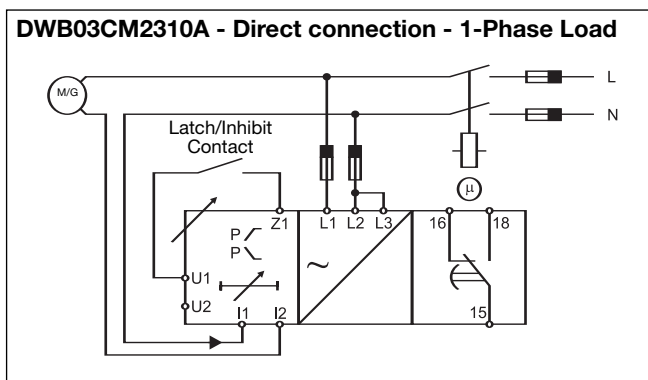
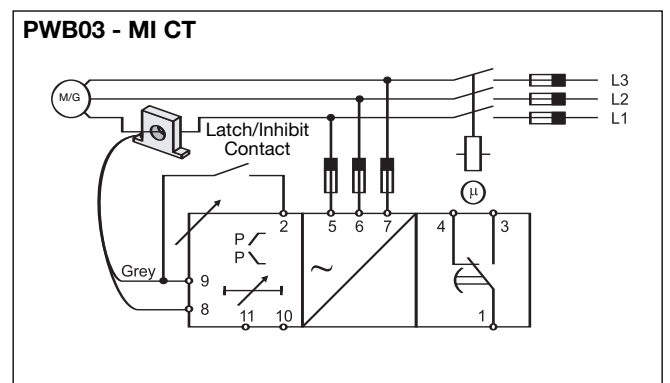
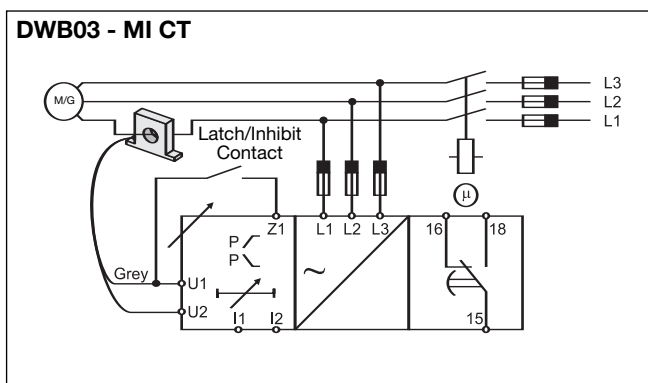
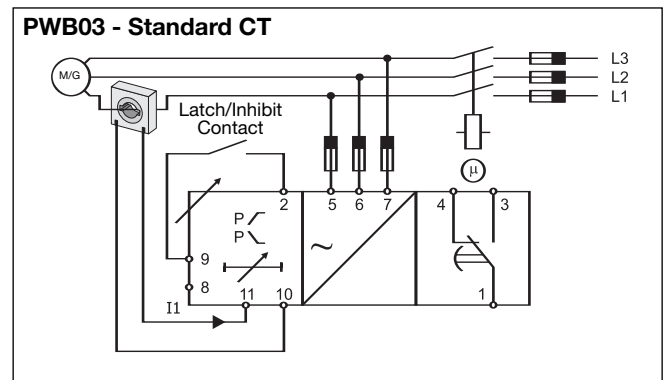
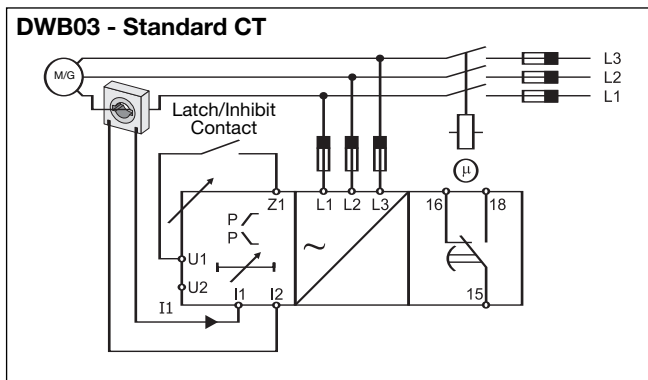

With the start/stop function enabled, it's necessary to use the following wiring diagrams (which are two examples among many others). It is possible for both 3-phases loads and of 1-phase loads, either through direct connection or external current metering transformer.

