

# PX2 SERIES

50069942  
Issue J

## Heavy Duty Pressure Transducers

PX2 Series, 1 bar to 70 bar | 100 kPa to 7 MPa |  
15 psi to 1000 psi

### DESCRIPTION

Honeywell's PX2 Series Heavy Duty Pressure Transducers are a portfolio of configurable pressure sensors that use piezoresistive sensing technology with ASIC (Application Specific Integrated Circuit) signal conditioning in a stainless steel housing. The PX2 Series is fully calibrated and compensated for offset, sensitivity, temperature effects and non-linearity using the on-board ASIC. These transducers measure absolute, sealed gage, or vented gage pressure. The absolute versions have an internal vacuum reference and an output value proportional to absolute pressure, sealed gage versions have an internal pressure reference of one atmosphere at sea level, and vented gage versions measure pressure with respect to ambient pressure. They are RoHS compliant and are designed and manufactured according to ISO 9001 standards.

### VALUE TO CUSTOMERS

- Media compatibility: Common HFC (hydrofluorocarbon) refrigerants such as R410A and R134A, next generation low global warming potential (GWP) refrigerants such as R448A (Solstice® N40), R32 and R1234ZE, engine oil, petroleum-based hydraulic fluids, DOT 3 brake fluid, and dry air. For ammonia and other corrosive media, see Honeywell's SPT Series.
- Enhanced durability: The PX2 Series can operate in the rigorous environments commonly found in HVAC/R and air compressor applications. The sensor can survive at least 10 million pressure cycles and has an ingress protection rating up to IP69K.

### POTENTIAL APPLICATIONS

- Industrial: Refrigerant pressure monitoring in HVAC/R systems; air compressor system pressure
- Transportation: Air system monitoring; hydraulic oil pressure monitoring

The PX2 Series is not recommended for use with media involving water, saturated air such as steam and vapor, and ammonia.

### FEATURES

- Pressure range: 1 bar to 70 bar | 100 kPa to 7 MPa | 15 psi to 1000 psi
- Pressure reference: Absolute, sealed gage or vented gage
- Pressure port types: 7/16-20 UNF 1/4 in 45° Flare Female Schrader (SAE J512), 7/16-20 UNF 45° Flare Male (SAE J513), 7/16-20 UNF 37° Flare Male (SAE J514), G1/4 (ISO 1179-3), G1/8 (ISO 1179-3), M12 x 1.5 (ISO 6149-3), 1/4-18 NPT, 1/8-27 NPT, 9/16-18 UNF, (SAE J1926-3), or 7/16-20 UNF (SAE J1926-3)
- Electrical connector types: Metri-Pack 150 (UL 94 HB or V-0 options), Micro M12, DIN, Deutsch, or cable harness (1 m, 2 m, 3 m, or 5 m)
- Total Error Band:  $\pm 2.0$  %FSS
- Operating and compensated temperature range:  $-40^{\circ}\text{C}$  to  $125^{\circ}\text{C}$  [ $-40^{\circ}\text{F}$  to  $257^{\circ}\text{F}$ ]
- Response time:  $< 2$  ms
- Life: Minimum of 10 million cycles to operating pressure
- Output transfer function: Ratiometric, regulated or current
- Mechanical shock rating: 100 G per MIL-STD-202F, Method 213B, Cond. F



- Vibration rating: 20 G sweep, 10 Hz to 2000 Hz
- Ingress protection: Up to IP69K
- Radiated immunity protection: Up to 100 V/m (ISO 11452-2)
- Flame retardant options: UL 94 HB standard on all electrical terminations; UL 94 V-0 available upon request



### PORTFOLIO

Honeywell offers a variety of heavy duty pressure transducers for potential use in aerospace, medical, transportation, agriculture, refrigeration, and industrial applications. To view the entire product portfolio, [click here](#).

# HEAVY DUTY PRESSURE TRANSDUCERS, PX2 SERIES

**TABLE 1. PERFORMANCE SPECIFICATIONS<sup>1</sup>**

CHARACTERISTIC	PARAMETER
Operating temperature range <sup>2</sup>	-40°C to 125°C [-40°F to 257°F]
Storage temperature range <sup>3</sup>	-40°C to 125°C [-40°F to 257°F]
Compensated temperature range <sup>4</sup>	-40°C to 125°C [-40°F to 257°F]
Overpressure minimum rating <sup>5</sup>	(See Table 3.)
Burst pressure minimum rating <sup>6</sup>	(See Table 3.)
Long term stability	±0.5 %FSS <sup>9</sup> (1000 hr at 25°C [77°F])
Accuracy <sup>7</sup>	±0.25 %FSS <sup>9</sup> (See Figure 1.)
Offset error <sup>8</sup>	±1 %FSS <sup>9</sup>
Total Error Band <sup>10</sup>	±2 %FSS <sup>9</sup> (-40°C to 125°C [-40°F to 257°F]) (See Figure 1.)
Response time <sup>11</sup>	<2 ms
Turn on time <sup>12</sup>	<7 ms
Life <sup>13</sup>	minimum of 10 million cycles to operating pressure

- <sup>1</sup> All specifications apply at 25°C and under operating conditions unless otherwise noted.
- <sup>2</sup> Operating Temperature Range: The temperature range over which the product will produce an output proportional to pressure but may not remain within the specified performance limits.
- <sup>3</sup> Storage Temperature Range: The temperature range over which the product may safely be exposed without excitation or pressure applied. Under these conditions the product will remain in specification after excursion to any temperatures within this range. Exposure to temperatures outside this range may cause permanent damage to the product.
- <sup>4</sup> Compensated Temperature Range: The temperature range (or ranges) over which the product will produce an output proportional to pressure within the specified performance limits.
- <sup>5</sup> Overpressure: The absolute maximum rating for pressure which may be safely applied to the product for it to remain in specification once pressure is returned to the operating pressure range. Exposure to higher pressure may cause permanent damage to the product.
- <sup>6</sup> Burst Pressure: The maximum pressure that may be applied to the product without causing escape of the pressure media. The product should not be expected to function after exposure to any pressure beyond the rated burst pressure. This rating is also the case burst rating of the product.
- <sup>7</sup> Accuracy: The maximum deviation in output from a Best Fit Straight Line (BFSL) fitted to the output measured over the pressure range at 25°C. Includes all errors due to pressure non-linearity, pressure hysteresis, and non-repeatability.
- <sup>8</sup> Offset Error: the maximum deviation in the output signal obtained when the reference pressure is applied at 25°C relative to the ideal transfer function.
- <sup>9</sup> Full Scale Span (FSS): The algebraic difference between the output signal measured at the maximum (Pmax.) and minimum (Pmin.) limits of the pressure range.
- <sup>10</sup> Total Error Band: The maximum deviation from the ideal transfer function over the entire compensated temperature and pressure range. Includes all errors due to offset, full scale span, pressure non-linearity, pressure hysteresis, repeatability, thermal effect on offset, thermal effect on span, and thermal hysteresis.
- <sup>11</sup> Response Time: The response time of the transducer is the maximum amount of time that the transducer will take for the transducer to output a change from 10% to 90% of full scale in response to a 0% to 100% full scale step input pressure range.
- <sup>12</sup> Turn On Time: Duration from power applied until first valid output.
- <sup>13</sup> Life may vary depending on the application in which transducer is used.

**FIGURE 1. TOTAL ERROR BAND (TEB)**

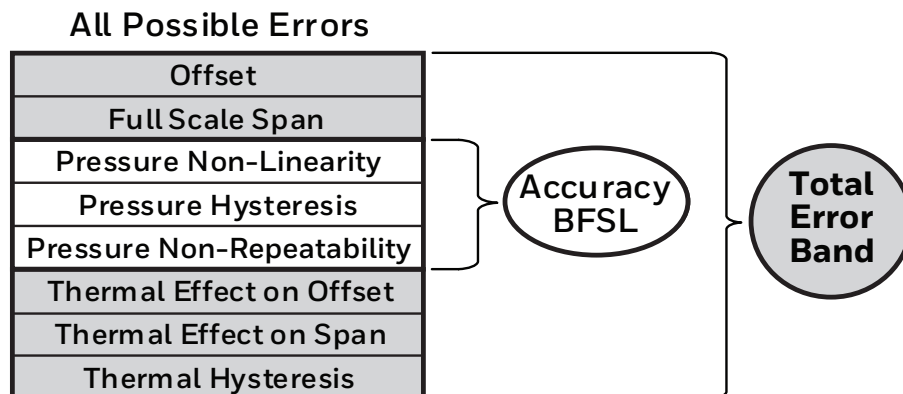

# HEAVY DUTY PRESSURE TRANSDUCERS, PX2 SERIES

**TABLE 2. ELECTRICAL SPECIFICATIONS**

CHARACTERISTIC	RATIOMETRIC OUTPUT				CURRENT OUTPUT	REGULATED OUTPUT				
	OUTPUT TRANSFER FUNCTION ORDER CODE <sup>1</sup>									
	AA	AB	AC	AD	CH	BC	BD	BE	BG	
Output transfer function <sup>1</sup> :										
null output value	10% of Vs	5% of Vs	10% of Vs	5% of Vs	4 mA	1 V	0.25 V	0.5 V	1 V	
full scale output value	90% of Vs	95% of Vs	90% of Vs	95% of Vs	4 mA	6 V	10.25 V	4.5 V	5 V	
full scale span (FSS)	80% of Vs	90% of Vs	80% of Vs	90% of Vs	16 mA	5 V	10 V	4 V	4 V	
operating supply voltage, min. (Vs) <sup>2</sup>	4.75 V	4.5 V	3.135 V	3.135 V	8 V	9 V	13 V	8 V	8 V	
operating supply voltage, typ. (Vs) <sup>2</sup>	5 V	5 V	3.3 V	3.3 V	—	—	—	—	—	
operating supply voltage, max. (Vs) <sup>2</sup>	5.25 V	5.5 V	3.465 V	3.465 V	30 V <sup>4</sup>	30 V <sup>3</sup>	30 V <sup>3</sup>	30 V <sup>3</sup>	30 V <sup>3</sup>	
Supply current (typ.)	5 mA		4 mA		—	5.5 mA				
Output load (pull up or down):										
minimum					—	2 kOhm				
maximum					(Vs - 8) x 50 Ohm <sup>4</sup>	—				
Absolute voltage ratings <sup>5</sup> :										
minimum <sup>6</sup>	-16 V				-16 V	-16 V				
maximum <sup>6</sup>	16 V				30 V	30 V				
maximum applied to output pin (short circuit protection) <sup>7</sup>	Vs				—	12 V				
EMC rating <sup>8</sup> :										
CE compliance:										
electrostatic discharge	±4 kV contact, ±8 kV air per IEC 61000-4-2									
radiated immunity	10 V/m (80 MHz to 1000 MHz) per IEC 61000-4-3									
fast transient burst	±1 kV per IEC61000-4-4									
immunity to conducted disturbances	3 V per IEC61000-4-6									
radiated emissions	40 dB 30 MHz to 230 MHz; 47 dB 230 MHz to 1000 MHz per CISPR 11									
ISO 11452-2 radiated immunity	100 V/m 200 MHz to 2 GHz					20 V/m 200 MHz to 2 GHz				

<sup>1</sup> Output transfer function options are shown in the Nomenclature and Order Guide. (See Figure 4.)

<sup>2</sup> Transducer will not produce valid output when supply voltage is outside of operating range.

<sup>3</sup> Applies at 25°C. See Figure 2 for Regulated Output Supply Voltage.

<sup>4</sup> Applies at 25°C. See Figure 3 for Current Output Supply Voltage.

<sup>5</sup> Absolute maximum ratings are the extreme limits the device can withstand without damage to the product. Voltages above these ratings may cause permanent damage. Exposure to absolute maximum conditions for extended periods may degrade device reliability.

<sup>6</sup> Absolute voltage applies to potential across power and ground terminals.

<sup>7</sup> Short circuit protection between output pin and ground, and output pin and supply pin.

<sup>8</sup> All EMC ratings verified with the Metri-Pack 150 electrical connector type.

**FIGURE 2. REGULATED OUTPUT SUPPLY VOLTAGE**

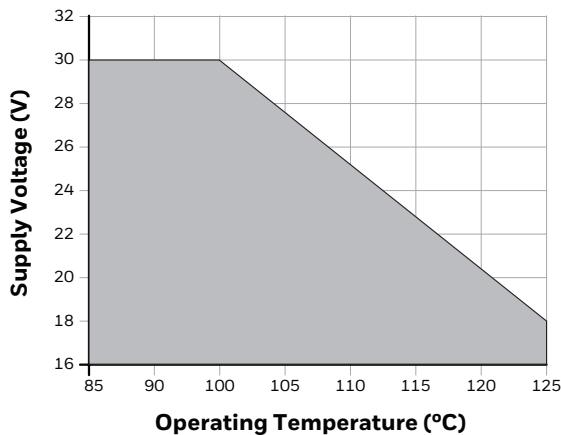

**FIGURE 3. CURRENT OUTPUT SUPPLY VOLTAGE**

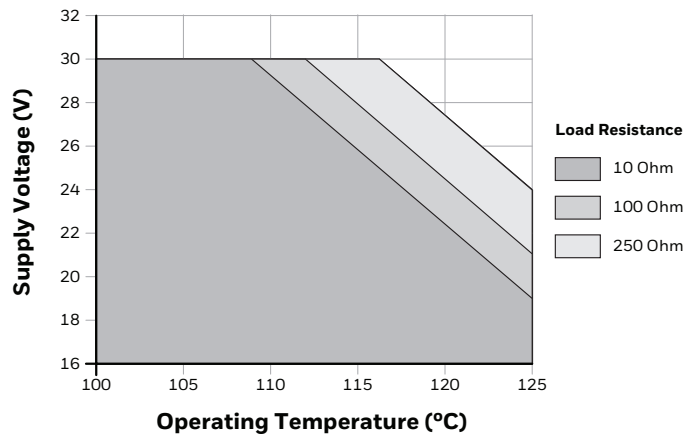

## HEAVY DUTY PRESSURE TRANSDUCERS, PX2 SERIES

**TABLE 3. PRESSURE RATINGS**

bar			kPa			MPa			psi		
Operating Pressure	Over-pressure	Burst Pressure	Operating Pressure	Over-pressure	Burst Pressure	Operating Pressure	Over-pressure	Burst Pressure	Operating Pressure	Over-pressure	Burst Pressure
1	5	8	100	500	800	1	3.1	5.1	15	70	115
1.6	5	8	160	1000	1700	1.6	5.2	8.6	30	150	250
2	10	17	250	1000	1700	2.5	6.9	10.3	50	250	400
2.5	10	17	400	1700	2700	4	6.9	10.3	100	450	750
4	17	27	600	3100	5100	4.6	6.9	10.3	150	450	750
6	31	51	–	–	–	6	13.8	20.6	200	750	1250
8	31	51	–	–	–	7	13.8	20.6	250	750	1250
10	31	51	–	–	–	–	–	–	300	1000	1500
16	52	86	–	–	–	–	–	–	500	1000	1500
25	69	103	–	–	–	–	–	–	600	1000	1500
34	69	103	–	–	–	–	–	–	667	1000	1500
40	69	103	–	–	–	–	–	–	750	1500	2250
46	69	103	–	–	–	–	–	–	800	1500	2250
60	138	206	–	–	–	–	–	–	850	2000	3000
70	138	206	–	–	–	–	–	–	1000	2000	3000

**TABLE 4. PRESSURE REFERENCE TYPES**

PRESSURE REFERENCE	DESCRIPTION
Absolute	Output is proportional to the difference between applied pressure and a built-in fixed reference to vacuum (zero pressure), where the minimum operating pressure is set to absolute zero pressure (perfect vacuum).
Sealed gage <sup>1</sup>	Output is proportional to the difference between applied pressure and a built-in fixed reference to 1 atmA, where the minimum operating pressure is set to 14.7 psiA (1 atmA).
Vented gage <sup>2</sup>	Sensor measures pressure relative to ambient pressure. Output is proportional to the difference between applied pressure and atmospheric (ambient) pressure, where the minimum operating pressure is set to atmospheric pressure.

<sup>1</sup> Sealed gage option only available in pressure ranges at or above 100 psi.

<sup>2</sup> Vented gage option only available in pressure ranges between 100 psi and 667 psi.

# HEAVY DUTY PRESSURE TRANSDUCERS, PX2 SERIES

**TABLE 5. ENVIRONMENTAL AND MECHANICAL CHARACTERISTICS**

CHARACTERISTIC	PARAMETER
Mechanical shock	100 G per MIL-STD-202F, Method 213B, Cond. F (at 25°C)
Vibration	20 G sweep, 10 Hz to 2000 Hz (at 25°C)
Enclosure rating	per electrical connector type selection (See Table 6.)
Wetted materials: port substrate adhesives electronics	304 stainless steel alumina ceramic epoxy glass, silicon
External materials: housing connector: UL 94 HB (standard) UL 94 V-0 (optional) cable jacket	304 stainless steel PBT 30% GF, black PBT 30% GF, natural (beige) TPE
Installation torque	per pressure port type (See Table 7.)

## CAUTION

### PRODUCT DAMAGE DUE TO MECHANICAL ISSUES

- Ensure torque specifications are determined for the specific application. Values provided are for reference only. (Mating materials and thread sealants can result in significantly different torque values from one application to the next.)
- When using mating parts made of stainless steel, use a thread sealant with anti-seize properties to prevent thread galling. Ensure the sealant is rated for the application.
- Use appropriate tools (such as an open ended wrench or deep well socket) to install transducers.
- Always hand-start transducers into the hole to prevent cross threading and damage.
- Ensure that torque is not applied to the electrical connector.
- Ensure that the proper mating electrical connector with a seal is used to connect the transducer. Improper or damaged seals can compromise ingress protection, leading to short circuits.

**Failure to comply with these instructions may result in product damage.**

## CAUTION

### PRODUCT DAMAGE DUE TO PARTICULATES

- Ensure that a filter is used upstream of the transducer to keep media flow free of larger particulates and increased humidity. All PX2 Series transducers are dead-ended devices; particulate accumulation and condensing moisture may affect sensor output.
- It is recommend that the transducer be positioned with the port facing downwards; any particulates in the system are less likely to enter and settle within the pressure transducer if it is in this position.
- Ensure that the media does not create a residue when dried. Build-up inside the transducer may affect transducer output; rinsing of a dead-ended transducer is potentially difficult and has limited effectiveness in removing residue.

**Failure to comply with these instructions may result in product damage.**

# HEAVY DUTY PRESSURE TRANSDUCERS, PX2 SERIES

FIGURE 4. NOMENCLATURE AND ORDER GUIDE

For example, **PX2AN1XX150PABDX** defines a PX2 Series Heavy Duty Pressure Transducer, Metripack 150, standard, electrical connector type, 1/4-18 NPT, pressure port type, 150 psi pressure range, absolute pressure reference, regulated: 0.25 Vdc to 10.25 Vdc output transfer function.

PX2 Series	A	N1	XX <sup>7</sup>	150P	A	BD	X <sup>7</sup>				
	Electrical Connector Type	Pressure Port Type		Pressure Range	Pressure Reference	Output Transfer Function					
	<b>A</b> Metri-Pack 150, Standard (UL 94 HB) <sup>2</sup> (For UL 94 V-0 version, see order code <b>J</b> below)	<b>F1</b> 7/16-20 UNF 1/4 in 45° Flare Female Schrader (SAE J51.2)	<b>001B</b> 1 bar <b>1.6B</b> 1.6 bar <b>002B</b> 2 bar <b>2.5B</b> 2.5 bar <b>004B</b> 4 bar <b>006B</b> 6 bar <b>008B</b> 8 bar <b>010B</b> 10 bar <b>016B</b> 16 bar <b>025B</b> 25 bar <b>040B</b> 40 bar <b>046B</b> 46 bar <b>060B</b> 60 bar <b>070B</b> 70 bar	<b>100K</b> 100 kPa <b>160K</b> 160 kPa <b>250K</b> 250 kPa <b>400K</b> 400 kPa <b>600K</b> 600 kPa <b>001G</b> 1 MPa <b>1.6G</b> 1.6 MPa <b>2.5G</b> 2.5 MPa <b>004G</b> 4 MPa <b>4.6G</b> 4.6 MPa <b>006G</b> 6 MPa <b>007G</b> 7 MPa	<b>A</b> Absolute <b>S</b> Sealed gage <sup>5</sup> <b>G</b> Vented gage <sup>6</sup>	<b>AA</b> Ratio metric: 5.0 V: 10 %/Vs to 90 %/Vs <b>AB</b> Ratio metric: 5.0 V: 5 %/Vs to 95 %/Vs <b>AC</b> Ratio metric: 3.3 V: 10 %/Vs to 90 %/Vs <b>AD</b> Ratio metric: 3.3 V: 5 %/Vs to 95 %/Vs <b>BC</b> Regulated: 1 Vdc to 6 Vdc <b>BD</b> Regulated: 0.25 Vdc to 10.25 Vdc <b>BE</b> Regulated: 0.5 Vdc to 4.5 Vdc <b>BG</b> Regulated: 1 Vdc to 5 Vdc <b>CH</b> Current: 4 mA to 20 mA	<b>015P</b> 1.5 psi <b>030P</b> 30 psi <b>050P</b> 50 psi <b>100P</b> 100 psi <b>150P</b> 150 psi <b>200P</b> 200 psi <b>250P</b> 250 psi <b>300P</b> 300 psi <b>500P</b> 500 psi <b>600P</b> 600 psi <b>667P</b> 667 psi <b>750P</b> 750 psi <b>01KP</b> 1000 psi	<b>001B</b> 1 bar <b>1.6B</b> 1.6 bar <b>002B</b> 2 bar <b>2.5B</b> 2.5 bar <b>004B</b> 4 bar <b>006B</b> 6 bar <b>008B</b> 8 bar <b>010B</b> 10 bar <b>016B</b> 16 bar <b>025B</b> 25 bar <b>040B</b> 40 bar <b>046B</b> 46 bar <b>060B</b> 60 bar <b>070B</b> 70 bar	<b>F1</b> 7/16-20 UNF 1/4 in 45° Flare Female Schrader (SAE J51.2) <b>F2</b> 7/16-20 UNF 45° Flare Male (SAE J51.3) <b>F3</b> 7/16-20 UNF 37° Flare Male (SAE J51.4) <b>G1</b> G1/4 (ISO 1179-3) <b>G2</b> G1/8 (ISO 1179-3) <b>M1</b> M12 x 1.5 (ISO 6149-3) <b>N1</b> 1/4-18 NPT <b>N2</b> 1/8-27 NPT <b>S1</b> 9/16-18 UNF (SAE J1926-3) <b>S2</b> 7/16-20 UNF (SAE J1926-3)	<b>E</b> Cable harness, 1 meter cable length <sup>3</sup> <b>F</b> Cable harness, 2 meter cable length <sup>3</sup> <b>G</b> Cable harness, 3 meter cable length <sup>3,4</sup> <b>H</b> Cable harness, 5 meter cable length <sup>3,4</sup> <b>J</b> Metri-Pack 150 (UL 94 V-0) <sup>2</sup>	

<sup>1</sup>Not all catalog listing combinations are available. Custom products are available. Please contact Honeywell.

<sup>2</sup>Metri-Pack 150 mating connectors with shielded cable and three 22 AWG wire are available from Honeywell. Order part no. 3685301 for 1 m (3.2 ft) cable length and part no. 3685302 for 3 m (9.8 ft) cable length.

<sup>3</sup>Three-wire cable is required for ratio metric and regulated outputs; two-wire cable is required for current output.

<sup>4</sup>Three meter and five meter cables are only available with Output Transfer Function CH = Current, 4 mA to 20 mA.

<sup>5</sup>Vented gage option only available in pressure ranges at or above 100 psi.

<sup>6</sup>Sealed gage option only available in pressure ranges between 100 psi and 667 psi (not available on cable harness configurations).

<sup>7</sup>Reserved for future use.

# HEAVY DUTY PRESSURE TRANSDUCERS, PX2 SERIES

**TABLE 6. ELECTRICAL CONNECTOR TYPE DIMENSIONS (FOR REFERENCE ONLY: MM/[IN.]**

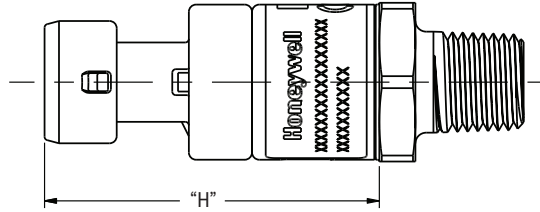

<b>A</b> <b>METRI-PACK 150, STANDARD</b> <b>(UL 94 HB)</b>			<b>B</b> <b>MICRO M12</b> <b>(IEC 61076-2)</b>			<b>C</b> <b>DIN</b> <b>(EN 175301-803C)</b>		
<b>J</b> <b>METRI-PACK 150</b> <b>(UL 94 V-0)</b>								
<b>Connector:</b> DELPHI 12078088 <b>Mating Connector:</b> DELPHI 12110192 <b>IP Rating<sup>1</sup>:</b> IP65 (all versions)			<b>Connector:</b> IEC 61076-2-101 <b>Mating Connector:</b> 4 POS TYPE D <b>IP Rating<sup>1</sup>:</b> IP65/IP67 (absolute, sealed gage versions) , IP65 (vented gage versions)			<b>Connector:</b> EN 175301-803C <b>Mating Connector:</b> EN 175301-803C DIN 43650C 8MM <b>IP Rating<sup>1</sup>:</b> IP65 (all versions)		
Pin	Voltage Output	Current Output	Pin	Voltage Output	Current Output	Pin	Voltage Output	Current Output
A	GND	RTN	1	V+	supply	1	GND	RTN
B	V+	supply	3	GND	RTN	2	V+	supply
C	Vout	NC	4	Vout	NC	3	Vout	NC
						PE	NC	NC

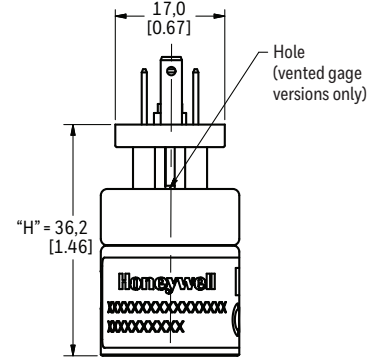
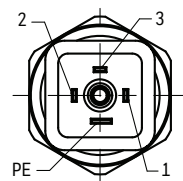
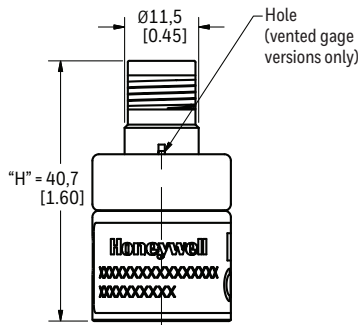
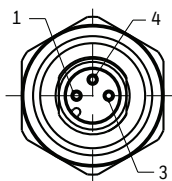
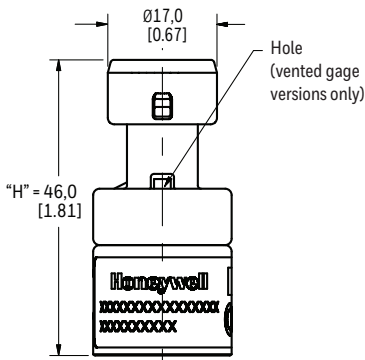
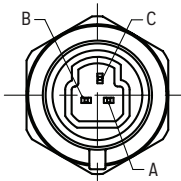

<sup>1</sup> IP rating is determined by the electrical connection chosen.

# HEAVY DUTY PRESSURE TRANSDUCERS, PX2 SERIES

**TABLE 6. ELECTRICAL CONNECTOR TYPE DIMENSIONS (CONTINUED)**

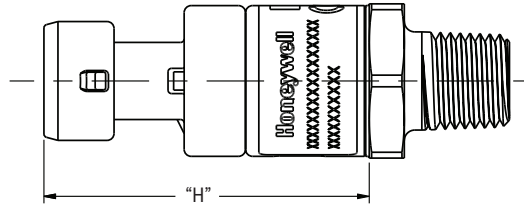

<b>D</b> <b>DEUTSCH</b> <b>(DTM04-3P)</b>	<b>E</b> CABLE HARNESS, 1 METER <sup>2</sup> <b>F</b> CABLE HARNESS, 2 METER <sup>2</sup> <b>G</b> CABLE HARNESS, 3 METER <sup>2,3</sup> <b>H</b> CABLE HARNESS, 5 METER <sup>2,3</sup>
---	--

**Connector:** Deutsch DTM04-3P  
**Mating Connector:** DTM06-3S  
**IP Rating<sup>1</sup>:** IP65, IP67, IP69K (absolute, sealed gage versions), IP65 (vented gage versions)

**Connector:** 24 AWG with TPE Jacket  
**Mating Connector:** Flying leads  
**IP Rating<sup>1</sup>:** IP65, IP67, IP69K (absolute, sealed gage versions)

Pin	Voltage Output	Current Output	Wire Color	Voltage Output	Wire Color	Current Output
1	GND	RTN	red	V+	red	supply
2	Vout	NC	black	GND	black	RTN
3	V+	supply	white	Vout		

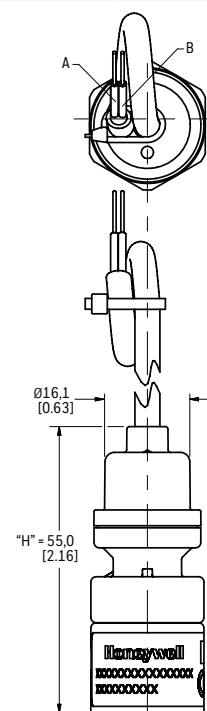
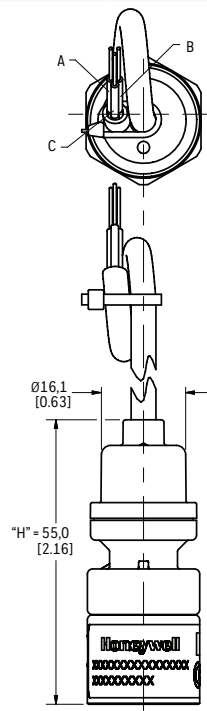
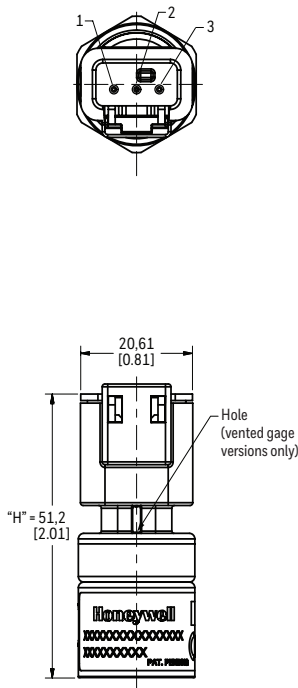

<sup>1</sup> IP rating is determined by the electrical connector type chosen.

<sup>2</sup> Three-wire cable is required for ratiometric and regulated outputs; two wire cable is required for current output.

<sup>3</sup> Three meter and five meter cables are only available with Output Transfer Function **CH** = Current, 4 mA to 20 mA.



# HEAVY DUTY PRESSURE TRANSDUCERS, PX2 SERIES

**TABLE 7. PRESSURE PORT TYPE DIMENSIONS (FOR REFERENCE ONLY: MM/[IN].)<sup>1</sup>**

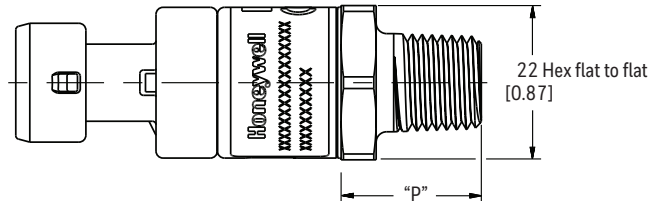

**F1 7/16-20 UNF 1/4 in 45° Flare Female Schrader (SAE J512)**

Seal: 45° cone

Mating geometry: SAE J512

Installation torque<sup>2</sup>: 17 N m [12.5 ft-lb]

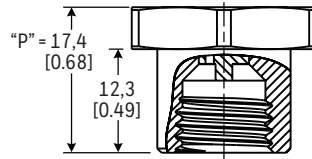

**F2 7/16-20 UNF 45° Flare Male (SAE J513)**

Seal: 45° cone

Mating geometry: SAE J513

Installation torque<sup>2</sup>: 1/4 Turn from finger tight

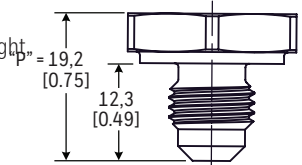

**F3 7/16-20 UNF 37° Flare Male (SAE J514)**

Seal<sup>3,4</sup>: 37° cone

Mating Geometry: SAE J514

Installation Torque<sup>2</sup>: 16 N m [11.8 ft-lb]

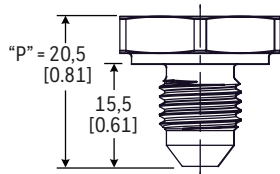

**G1 G1/4 (ISO 1179-3)**

Seal<sup>3,4</sup>: O-ring

Mating geometry: ISO 1179-1

Installation torque<sup>2</sup>: 50 N m [38.9 ft-lb]

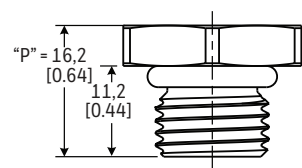

**G2 G1/8 (ISO 1179-3)**

Seal<sup>3,4</sup>: O-ring

Mating geometry: ISO 1179-1

Installation torque<sup>2</sup>: 25 N m [18.4 ft-lb]

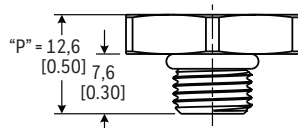

**M1 M12 X 1.5 (ISO 6149-3)**

Seal<sup>3</sup>: O-ring

Mating geometry: ISO 6149-1

Installation torque<sup>2</sup>: 25 N m [18.4 ft-lb]

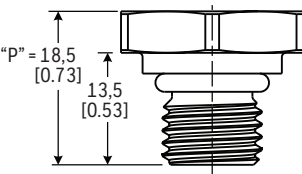

**N1 1/4-18 NPT**

Seal: pipe thread

Mating geometry: ANSI B1.20.1

Installation torque<sup>2</sup>: 2 to 3 turns from finger tight

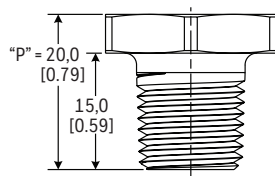

**N2 1/8-27 NPT**

Seal: pipe thread

Mating geometry: ANSI B1.20.1

Installation torque<sup>2</sup>: 2 to 3 turns from finger tight

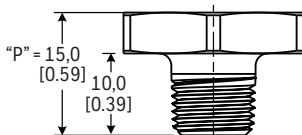

**S1 9/16-18 UNF (SAE J1926-3)**

Seal<sup>3,4</sup>: O-ring

Mating geometry: SAE J1926-1

Installation torque<sup>2</sup>: 30 N m [22.1 ft-lb]

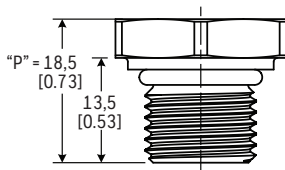

**S2 7/16-20 UNF (SAE J1926-3)**

Seal<sup>3,4</sup>: O-ring

Mating geometry: SAE J1926-1

Installation torque<sup>2</sup>: 18 N m [12.3 ft-lb]

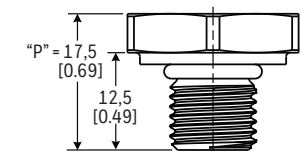

<sup>1</sup> See **CAUTION "PRODUCT DAMAGE DUE TO MECHANICAL ISSUES"** on page 5.

<sup>2</sup> Straight thread maximum torque is validated to 150% of installation torque.

<sup>3</sup> Seals for pressure port type order codes **S1**, **S2**, **M1**, **G1** and **G2** are included and assembled to the sensors.

<sup>4</sup> O-ring material is nitrile 70 durometer -30°C to 125°C [-22°F to 257°F].