

PXAE263708NB

Thermally-Enhanced High Power RF LDMOS FET
400 W (P_{3dB}), 28 V, 2620 – 2690 MHz

Description

The PXAE263708NB is a 400-watt (P_{3dB}) LDMOS FET intended for use in multi-standard cellular power amplifier applications in the 2620 to 2690 MHz frequency band. Features include input and output matching, high gain and a thermally-enhanced package with earless flange. Manufactured with Wolfspeed's advanced LDMOS process, this device provides excellent thermal performance and superior reliability.

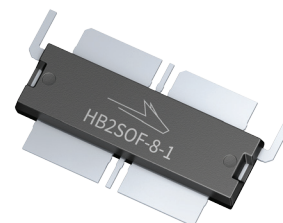

PXAE263708NB
Package PG-HB2SOF-8-1

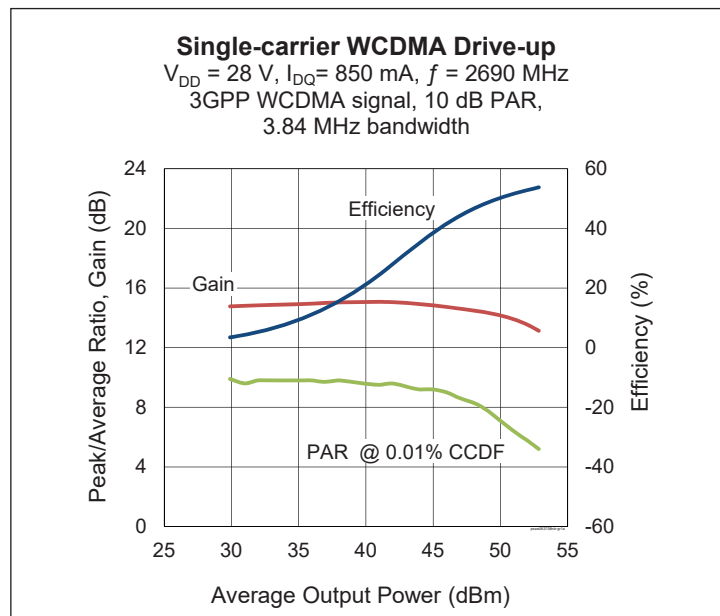

Features

- Broadband internal input and output matching
- Asymmetric Doherty design
 - Main: $P_{1dB} = 140\text{ W Typ}$
 - Peak: $P_{1dB} = 260\text{ W Typ}$
- Typical pulsed CW performance, 2655 MHz, 28 V, Doherty configuration, 10 μs , 10% duty cycle, class AB
 - Output power at $P_{1dB} = 200\text{ W}$
 - Output power at $P_{3dB} = 400\text{ W}$
 - Efficiency = 49% ($P_{OUT} = 57\text{ W avg}$)
 - Gain = 15 dB ($P_{OUT} = 57\text{ W avg}$)
- Capable of handling 10:1 VSWR @ 32 V, 100 W (CW) output power
- Integrated ESD protection
- Human Body Model Class 2 (per ANSI/ESDA/JEDEC JS-001)
- Low thermal resistance
- Pb-free and RoHS compliant

RF Characteristics

Single-carrier WCDMA Specifications (tested in Wolfspeed Doherty production test fixture)

$V_{DD} = 28\text{ V}$, $I_{DQ} = 850\text{ mA}$, $P_{OUT} = 57\text{ W avg}$, $V_{GSPK} = 1.5\text{ V}$, $f = 2690\text{ MHz}$, 3GPP signal, channel bandwidth = 3.84 MHz, peak/average = 10 dB @ 0.01% CCDF

Characteristic	Symbol	Min	Typ	Max	Unit
Gain	G_{ps}	12.5	13.5	—	dB
Drain Efficiency	η_D	42.5	46.5	—	%
Adjacent Channel Power Ratio	ACPR	—	-27	-23	dBc
Output PAR at 0.01% probability on CCDF	OPAR	7	7.7	—	dB

All published data at $T_{CASE} = 25^\circ\text{C}$ unless otherwise indicated

ESD: Electrostatic discharge sensitive device—observe handling precautions!



DC Characteristics

Characteristic	Conditions	Symbol	Min	Typ	Max	Unit
Drain-Source Breakdown Voltage	$V_{GS} = 0\text{ V}, I_{DS} = 10\text{ mA}$	$V_{(BR)DSS}$	65	—	—	V
Drain Leakage Current	$V_{DS} = 28\text{ V}, V_{GS} = 0\text{ V}$	I_{DSS}	—	—	1	μA
	$V_{DS} = 60\text{ V}, V_{GS} = 0\text{ V}$	I_{DSS}	—	—	10	μA
Gate Leakage Current	$V_{GS} = 10\text{ V}, V_{DS} = 0\text{ V}$	I_{GSS}	—	—	1	μA
On-State Resistance	(main) $V_{GS} = 10\text{ V}, V_{DS} = 0.1\text{ V}$	$R_{DS(on)}$	—	0.08	—	Ω
	(peak) $V_{GS} = 10\text{ V}, V_{DS} = 0.1\text{ V}$	$R_{DS(on)}$	—	0.04	—	Ω
Operating Gate Voltage	(main) $V_{DS} = 28\text{ V}, I_{DQ} = 850\text{ mA}$	V_{GS}	2.7	3.1	3.5	V
	(peak) $V_{DS} = 28\text{ V}, I_{DQ} = 0\text{ mA}$	V_{GS}	—	1.5	—	V

Maximum Ratings

Parameter	Symbol	Value	Unit
Drain-Source Voltage	V_{DSS}	65	V
Gate-Source Voltage	V_{GS}	-6 to +10	V
Operating Voltage	V_{DD}	0 to +32	V
Junction Temperature	T_J	225	$^{\circ}\text{C}$
Storage Temperature Range	T_{STG}	-65 to +150	$^{\circ}\text{C}$

Thermal Characteristics

$T_{CASE} = 70^{\circ}\text{C}, V_{DD} = 28\text{ V}, I_{DQ} = 850\text{ mA}, 2,655\text{ MHz}$

Characteristic	Symbol	Value	Unit	
Thermal Resistance	main - 57 W CW	$R_{\theta JC}$	0.61	$^{\circ}\text{C}/\text{W}$
	peak - 200 W CW	$R_{\theta JC}$	0.25	$^{\circ}\text{C}/\text{W}$

Moisture Sensitivity Level

Level	Test Standard	Package Temperature	Unit
3	IPC/JEDEC J-STD-020	260	$^{\circ}\text{C}$

Ordering Information

Type and Version	Order Code	Package and Description	Shipping
PXAE263708NB V1 R2	PXAE263708NB-V1-R2	PG-HB2SOF-8-1, overmold with earless flange	Tape & Reel, 250 pcs

Typical Performance (data taken in test fixture)

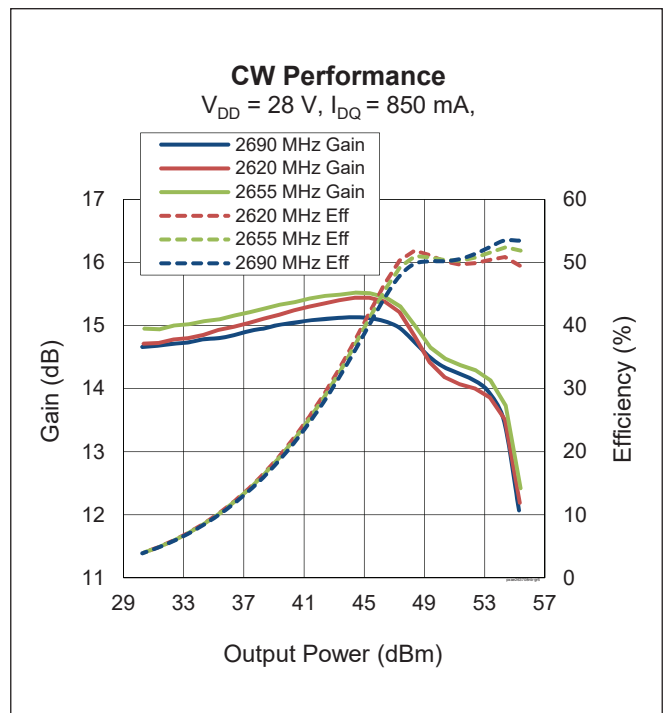
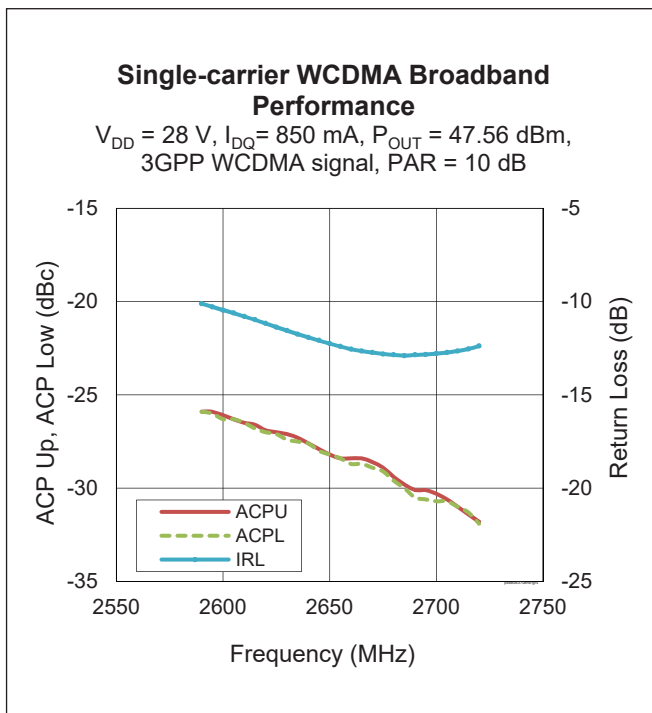
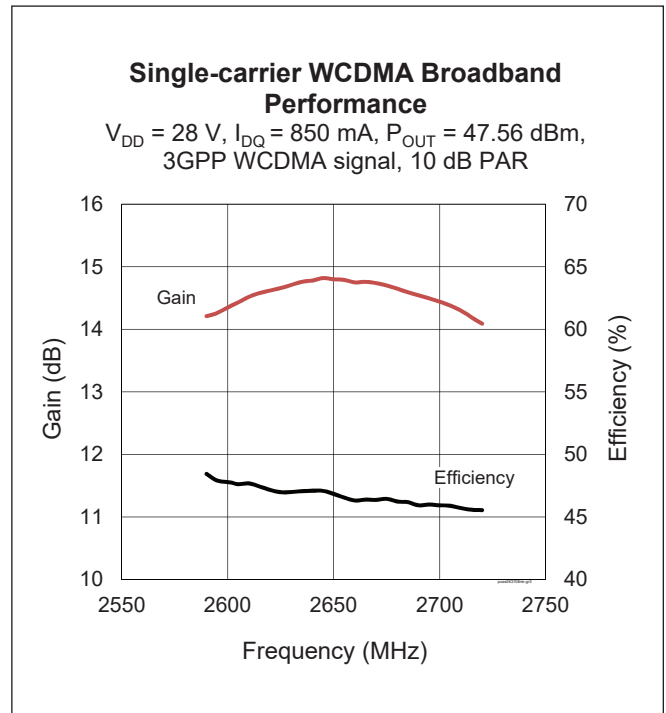
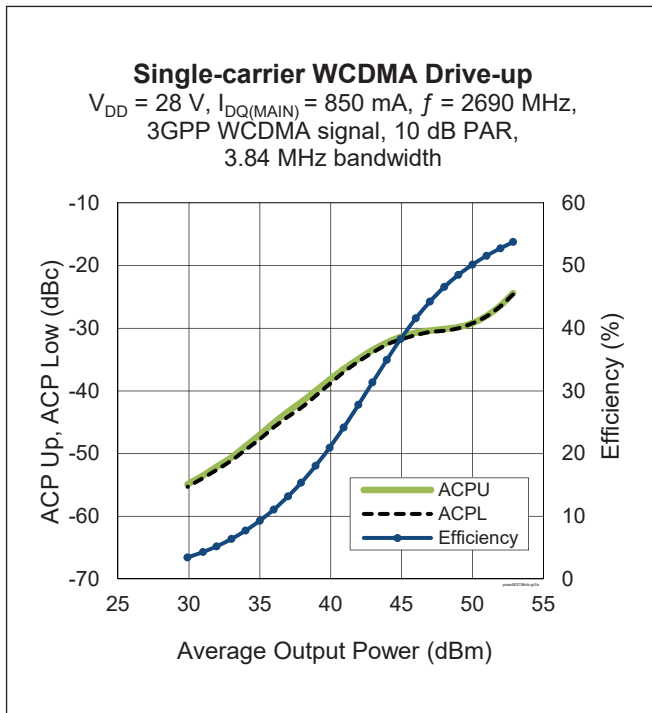



Typical Performance (cont.)

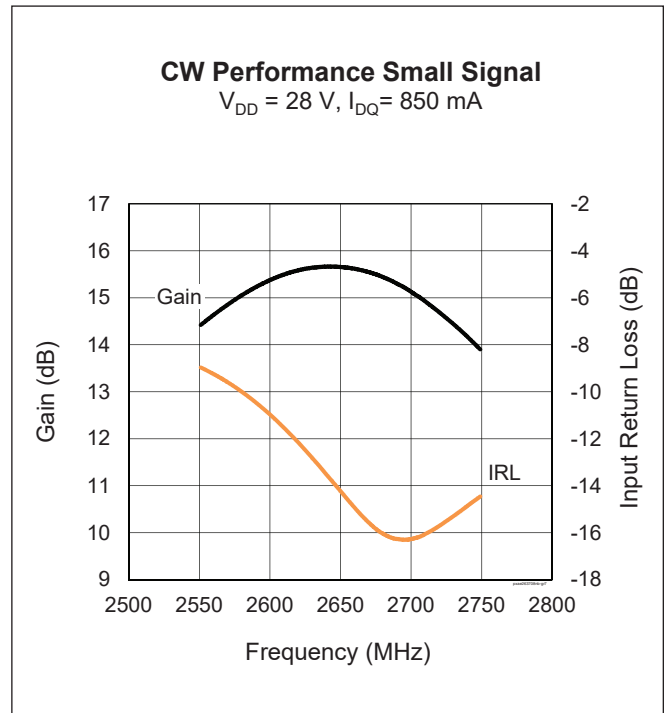
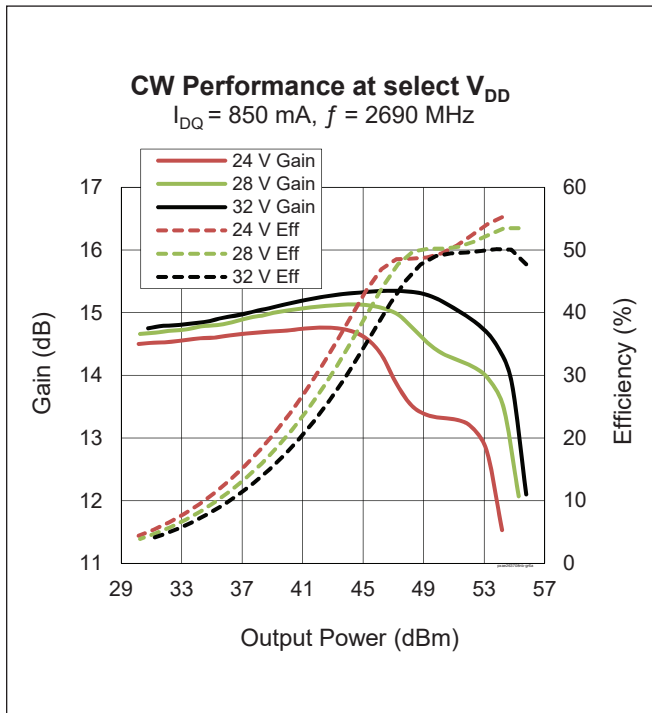

See next page for Load Pull Performance

Load Pull Performance

Main Side Load Pull Performance – Pulsed CW signal: 10 μ s, 10% duty cycle, 28 V, I_{DQ} = 850 mA, class AB

		P_{1dB}									
		Max Output Power					Max Drain Efficiency				
Freq [MHz]	Zs [Ω]	ZL [Ω]	Gain [dB]	P_{1dB} [dBm]	P_{1dB} [W]	η_D [%]	ZL [Ω]	Gain [dB]	P_{1dB} [dBm]	P_{1dB} [W]	η_D [%]
2620	6.9 – j11	1.5 – j4.9	16.2	51.8	152	51.0	3.1 – j3.5	18.5	50.1	103	63.6
2655	9.2 – j12	1.5 – j5.1	16.6	52.0	158	54.0	2.7 – j3.8	18.6	50.6	115	64.2
2690	12.8 – j11	1.5 – j5.1	16.6	51.8	152	52.4	2.8 – j3.9	18.6	50.2	105	62.6

		P_{3dB}									
		Max Output Power					Max Drain Efficiency				
Freq [MHz]	Zs [Ω]	ZL [Ω]	Gain [dB]	P_{3dB} [dBm]	P_{3dB} [W]	η_D [%]	ZL [Ω]	Gain [dB]	P_{3dB} [dBm]	P_{3dB} [W]	η_D [%]
2620	6.9 – j11	1.6 – j5.0	14.5	52.60	182	54.9	3.0 – j3.5	16.4	51.00	126	63.7
2655	9.2 – j12.1	1.4 – j5.2	14.3	52.80	191	54.0	2.5 – j3.9	16.5	51.50	141	64.8
2690	12.8 – j11.3	1.5 – j5.4	14.5	52.70	186	53.8	2.6 – j3.8	16.6	51.00	126	63.4

Peak Side Load Pull Performance – Pulsed CW signal: 10 μ s, 10% duty cycle, 28 V, V_{GSPK} = 1.7 V, class C

		P_{1dB}									
		Max Output Power					Max Drain Efficiency				
Freq [MHz]	Zs [Ω]	ZL [Ω]	Gain [dB]	P_{1dB} [dBm]	P_{1dB} [W]	η_D [%]	ZL [Ω]	Gain [dB]	P_{1dB} [dBm]	P_{1dB} [W]	η_D [%]
2620	2.9 – j7.1	3.3 – j7.9	12.2	54.70	295	53.0	3.2 – j4.6	13.2	52.90	195	63.7
2655	3.5 – j7.6	3.4 – j8.3	12.6	54.80	302	54.0	2.8 – j4.9	13.8	52.60	182	64.8
2690	4.7 – j7.9	4.5 – j9.0	12.6	54.70	295	53.7	3.2 – j5.3	13.7	52.60	182	63.6

		P_{3dB}									
		Max Output Power					Max Drain Efficiency				
Freq [MHz]	Zs [Ω]	ZL [Ω]	Gain [dB]	P_{3dB} [dBm]	P_{3dB} [W]	η_D [%]	ZL [Ω]	Gain [dB]	P_{3dB} [dBm]	P_{3dB} [W]	η_D [%]
2620	2.9 – j7.1	3.5 – j7.9	10.3	55.40	347	54.6	3.2 – j5.0	11.3	53.80	240	62.9
2655	3.5 – j7.6	3.7 – j8.6	10.5	55.40	347	54.3	3.2 – j5.7	11.7	54.10	257	64.0
2690	4.7 – j7.9	4.6 – j9.2	10.5	55.40	347	54.1	3.8 – j6.2	11.6	54.20	263	62.6

Reference Circuit, 2620 – 2690 MHz

Reference Circuit Assembly

DUT	PXAE263708NB V1
Test Fixture Part No.	LTA/PXAE263708NB-V1
PCB	Rogers 4350, 0.508 mm [0.020"] thick, 2 oz. copper, ϵ_r = 3.66

Find Gerber files for this test fixture on the Wolfspeed Web site at www.wolfspeed.com/RF

Reference Circuit (cont.)

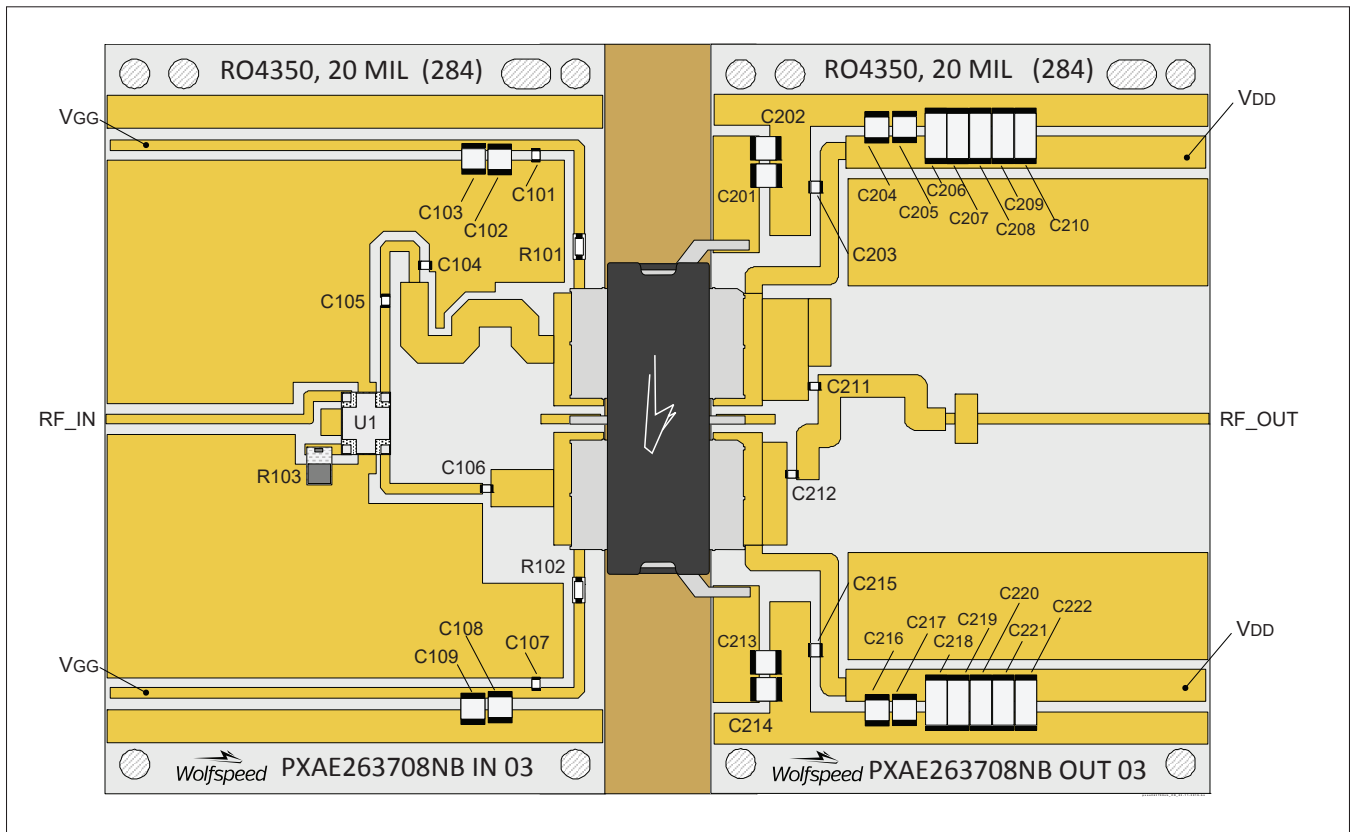

Reference circuit assembly diagram (not to scale)

Components Information

Component	Description	Manufacturer	P/N
Input			
C101, C105, C106, C107	Capacitor, 12 pF	ATC	ATC800A120JT250XT
C102, C103, C108, C109	Capacitor, 10 μ F, 50 V	Taiyo Yuden	UMK325C7106MM-T
C104	Capacitor, 0.5 pF	ATC	ATC800A0R5CT250XT
R101, R102	Resistor, 10 ohms	Panasonic Electronic Components	ERJ-8GEYJ100V
R103	Resistor, 50 ohms	Anaren	C8A50Z4A
U1	Hybrid coupler	Anaren	X3C25P1-05S
Output			
C201, C202, C204, C205, C213, C214, C216, C217	Capacitor, 10 μ F, 50 V	Taiyo Yuden	UMK325C7106MM-T
C203, C215	Capacitor, 12 pF	ATC	ATC800A120JT250XT
C206, C207, C208, C209, C210, C218, C219, C220, C221, C222	Capacitor, 10 μ F, 100 V	TDK Corporation	C5750X7S2A106M230KB
C211	Capacitor, 3.3 pF	ATC	ATC800A3R3CT250XT
C212	Capacitor, 8.2 pF	ATC	ATC800A8R2CT250T

Pinout Diagram (top view)

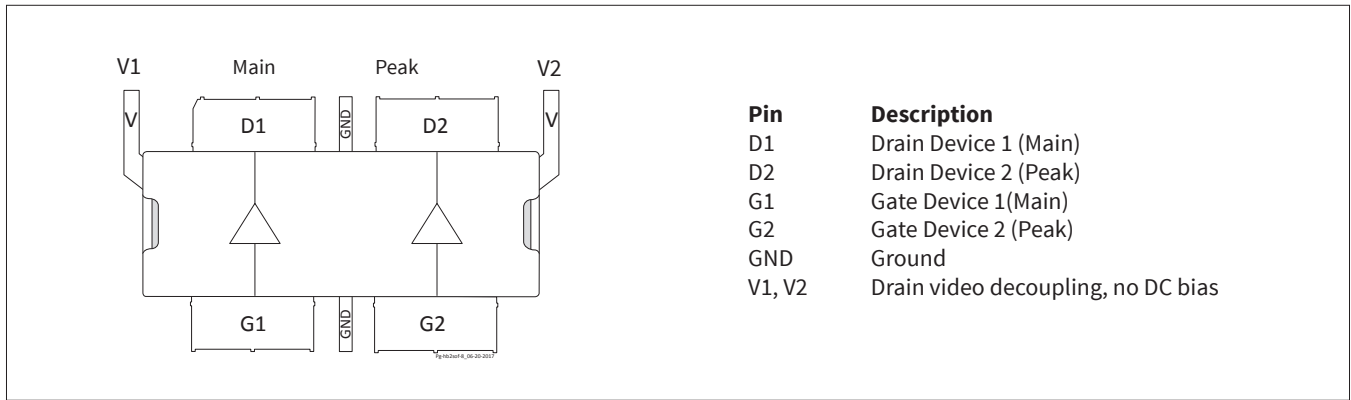

Lead connections for PXAE263708NB

See next page for Package Outline Specifications

Package Outline Specifications

Package PG-HB2SOF-8-1

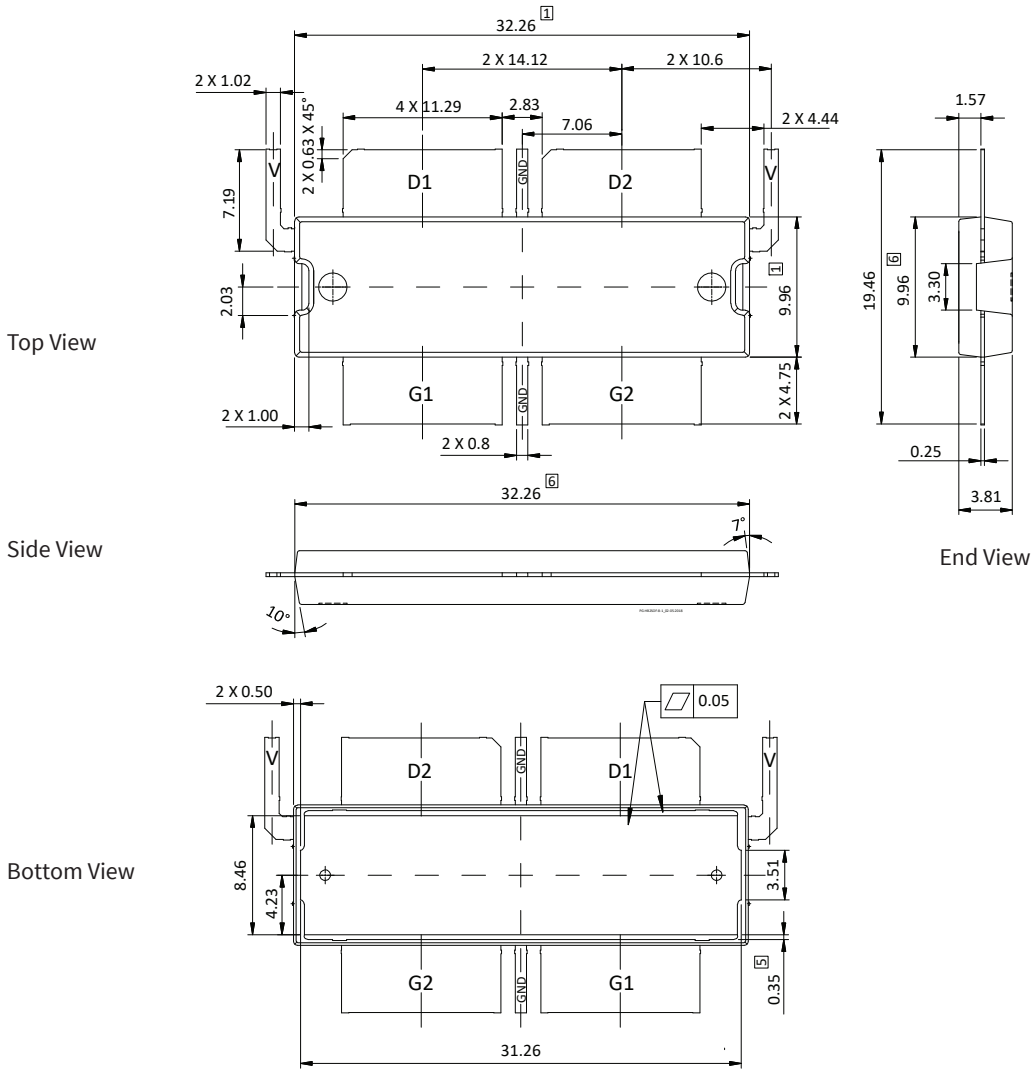

Diagram Notes—unless otherwise specified:

1. Mold/dam bar/metal protrusion of 0.30 mm max per side not included
2. Fillets and radii: all radii are 0.30 mm max unless specified otherwise
3. Interpret dimensions and tolerances per ISO 8015
4. Dimensions are mm
5. Exposed metal surface are tin plated, may not be covered by mold compound
6. Does not include mold/dam bar/metal protrusion.
7. All tolerances ± 0.1 mm unless specified otherwise
8. All metal surfaces pre-plated, except area of cut
9. Lead thickness: 0.25 mm
10. Pins: D1, D2 – drain; G1, G2 – gate; V – V_{DD}; GND – ground, (Source – bottom metallization)

Find the latest and most complete information about products and packaging at the Wolfspeed Internet page www.wolfspeed.com/RF