



PZ1AH3V6B-AU~PZ1AH75B-AU

SILICON ZENER DIODE

VOLTAGE

3.6V~75V

POWER

1Watt

Features

- Silicon planar Zener diode
- Low profile surface-mount package
- Low leakage current
- Excellent stability
- AEC-Q101 qualified
- High temperature soldering : 260 °C/10 seconds at terminals
- Lead free in compliance with EU RoHS 2.0
- Green molding compound as per IEC 61249 standard

Mechanical Data

- Case: SOD-123HE, plastic
- Terminals: Solderable per MIL-STD-750, Method 2026
- Polarity: Color band denotes cathode end
- Approx. Weight: 0.0006 ounces, 0.0184 grams

SOD-123HE

Unit: inch(mm)

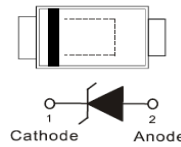
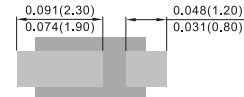
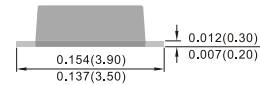
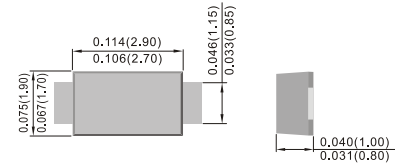

Maximum Ratings ($T_A=25^{\circ}\text{C}$ unless otherwise noted)

PARAMETER	SYMBOL	LIMIT	UNITS
Peak Pulse Power Dissipation at $T_A=25^{\circ}\text{C}$ (Notes 1)	P_D	1	W
ESD Voltage per IEC61000-4-2 (Air)	V_{ESD}	± 30	kV
ESD Voltage per IEC61000-4-2 (Contact)		± 30	
Typical Thermal Resistance (Notes 2)	$R_{\theta JA}$	185	$^{\circ}\text{C}/\text{W}$
Operating Junction Temperature Range	T_J	-55 to +150	$^{\circ}\text{C}$
Storage Temperature Range	T_{STG}	-55 to +150	$^{\circ}\text{C}$

NOTES :

1. Mounted on a 5mm^2 copper pads to each terminal.
2. Mounted on a FR-4 PCB, single-sided copper, mini pad .



PZ1AH3V6B-AU~PZ1AH75B-AU

Electrical Characteristics ($T_A=25^{\circ}\text{C}$ unless otherwise noted)

Part Number	Nominal Zener Voltage				Nominal Zener Impedance				Max. Reverse Leakage Current		Marking Code
	$V_Z@I_{ZT}$				$Z_{ZT}@I_{ZT}$		$Z_{ZK}@I_{ZK}$		$I_R@V_R$		
	Nom. V	Min. V	Max. V	mA	Ω	mA	Ω	mA	μA	V	
PZ1AH3V6B-AU	3.6	3.42	3.78	100	8	100	400	1	100	1	ACH
PZ1AH3V9B-AU	3.9	3.71	4.10	100	8	100	400	1	50	1	BCH
PZ1AH4V3B-AU	4.3	4.09	4.52	100	7	100	400	1	25	1	CCH
PZ1AH4V7B-AU	4.7	4.47	4.94	100	7	100	500	1	10	1	DCH
PZ1AH5V1B-AU	5.1	4.85	5.36	100	6	100	550	1	5	1	ECH
PZ1AH5V6B-AU	5.6	5.32	5.88	100	4	100	600	1	10	2	FCH
PZ1AH6V0B-AU	6	5.7	6.3	100	3	100	650	1	8	2	HCH
PZ1AH6V2B-AU	6.2	5.89	6.51	100	3	100	700	1	5	2	ICH
PZ1AH6V8B-AU	6.8	6.46	7.14	100	3	100	700	1	10	3	JCH
PZ1AH7V5B-AU	7.5	7.13	7.88	100	2	100	700	0.5	10	3	KCH
PZ1AH8V2B-AU	8.2	7.79	8.61	100	2	100	700	0.5	10	3	LCH
PZ1AH8V7B-AU	8.7	8.27	9.14	50	3	50	700	0.5	10	4	MCH
PZ1AH9V1B-AU	9.1	8.65	9.56	50	4	50	700	0.5	10	5	NCH
PZ1AH10B-AU	10	9.50	10.50	50	4	50	700	0.25	7	7.5	PCH
PZ1AH11B-AU	11	10.45	11.55	50	7	50	700	0.25	4	8.2	RCH
PZ1AH12B-AU	12	11.40	12.60	50	7	50	700	0.25	3	9.1	SCH
PZ1AH13B-AU	13	12.35	13.65	50	10	50	700	0.25	2	10	TCH
PZ1AH14B-AU	14	13.30	14.70	50	10	50	700	0.25	2	11	UCH
PZ1AH15B-AU	15	14.25	15.75	50	12	50	700	0.25	1	11	VCH
PZ1AH16B-AU	16	15.20	16.80	25	15	25	700	0.25	1	12	WCH
PZ1AH17B-AU	17	16.15	17.85	25	15	25	750	0.25	1	13	XCH
PZ1AH18B-AU	18	17.10	18.90	25	15	25	750	0.25	1	13	YCH
PZ1AH19B-AU	19	18.05	19.95	25	15	25	750	0.25	1	14	ZCH
PZ1AH20B-AU	20	19.00	21.00	25	15	25	750	0.25	1	15	2CH
PZ1AH22B-AU	22	20.90	23.10	25	15	25	750	0.25	1	16	3CH
PZ1AH24B-AU	24	22.80	25.20	25	15	25	750	0.25	1	18	4CH
PZ1AH25B-AU	25	23.75	26.25	25	15	25	750	0.25	1	19	6CH
PZ1AH27B-AU	27	25.65	28.35	25	15	25	750	0.25	1	20	7CH
PZ1AH28B-AU	28	26.60	29.40	25	15	25	850	0.25	1	21	9CH



PZ1AH3V6B-AU~PZ1AH75B-AU

Electrical Characteristics ($T_A=25^{\circ}\text{C}$ unless otherwise noted)

Part Number	Nominal Zener Voltage				Nominal Zener Impedance				Max. Reverse Leakage Current		Marking Code
	$V_Z@I_{ZT}$				$Z_{ZT}@I_{ZT}$		$Z_{ZK}@I_{ZK}$		$I_R@V_R$		
	Nom. V	Min. V	Max. V	mA	Ω	mA	Ω	mA	μA	V	
PZ1AH30B-AU	30	28.50	31.50	25	15	25	1000	0.25	1	22	AEH
PZ1AH33B-AU	33	31.35	34.65	25	15	25	1000	0.25	1	24	BEH
PZ1AH36B-AU	36	34.20	37.80	10	40	10	1000	0.25	1	27	CEH
PZ1AH39B-AU	39	37.05	40.95	10	40	10	1000	0.25	1	30	DEH
PZ1AH43B-AU	43	40.85	45.15	10	45	10	1500	0.25	1	33	EEH
PZ1AH47B-AU	47	44.65	49.35	10	45	10	1500	0.25	1	36	FEH
PZ1AH51B-AU	51	48.45	53.55	10	60	10	1500	0.25	1	39	HEH
PZ1AH56B-AU	56	53.20	58.80	10	60	10	2000	0.25	1	43	IEH
PZ1AH62B-AU	62	58.90	65.10	10	80	10	2000	0.25	1	47	JEH
PZ1AH68B-AU	68	64.60	71.40	10	80	10	2000	0.25	1	51	KEH
PZ1AH75B-AU	75	71.25	78.75	10	100	10	2000	0.25	1	56	LEH



PZ1AH3V6B-AU~PZ1AH75B-AU

TYPICAL CHARACTERISTIC CURVES

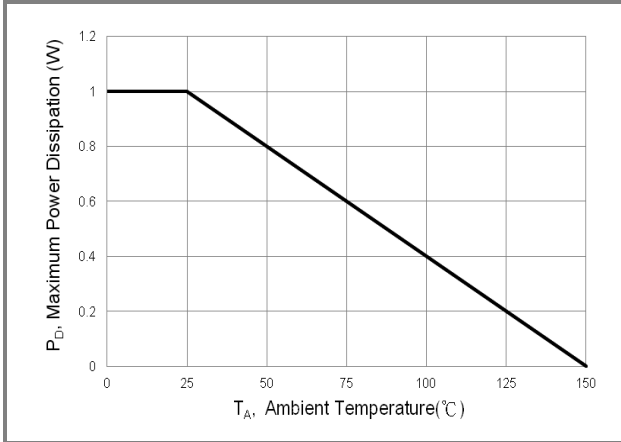

Fig.1 Steady-State Power Derating Curve

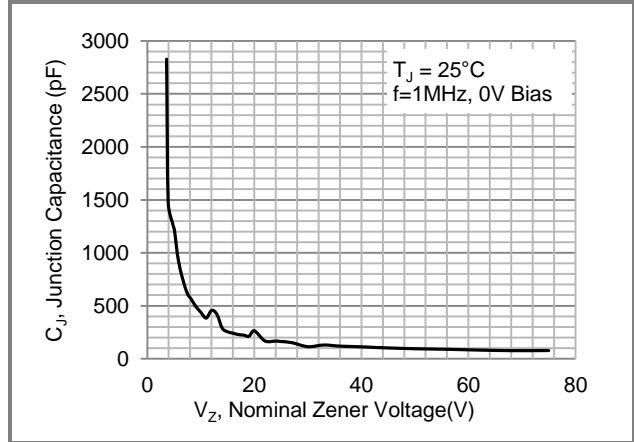

Fig.2 Typical Capacitance Versus V_Z

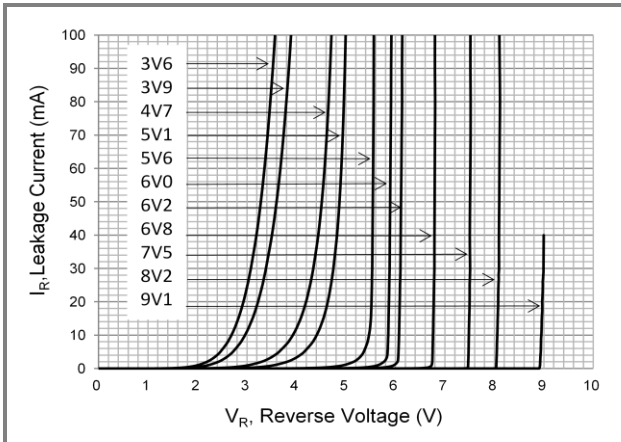

Fig.3 Typical Zener Breakdown Characteristics

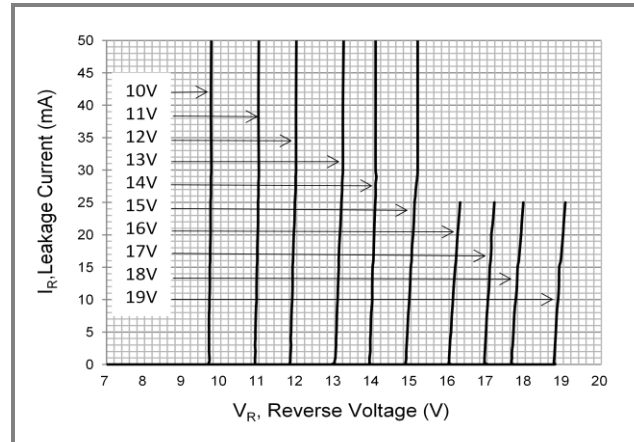

Fig.4 Typical Zener Breakdown Characteristics

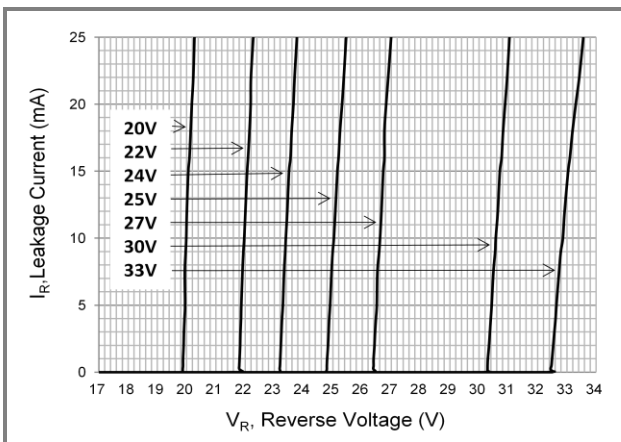

Fig.5 Typical Zener Breakdown Characteristics

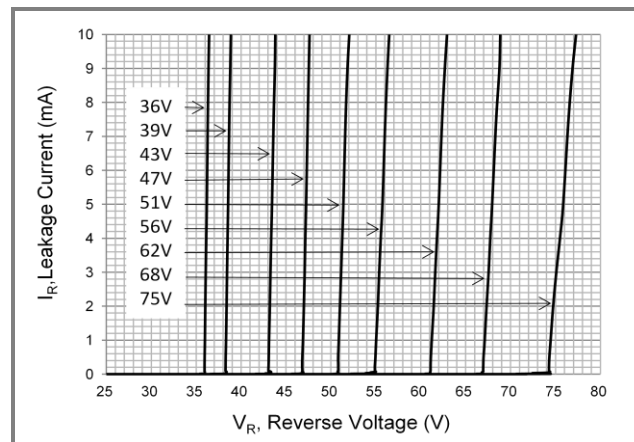

Fig.6 Typical Zener Breakdown Characteristics



PZ1AH3V6B-AU~PZ1AH75B-AU

Part No Packing Code Version

Part No Packing Code	Package Type	Packing Type	Marking	Version
PZ1AH3V6B-AU_R1_000A1	SOD-123HE	3K pcs / 7" reel	ACH	Halogen free
PZ1AH3V6B-AU_R2_000A1	SOD-123HE	10K pcs / 13" reel	ACH	Halogen free

Mounting Pad Layout

