

Agency Approval

Agency	Agency File Number
	L Package : E71639

Schematic Symbol

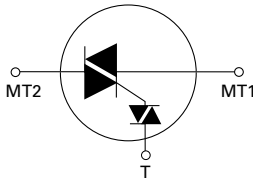

Main Features

Symbol	Value	Unit
$I_{T(RMS)}$	4 to 15	A
V_{DRM} / V_{RRM}	400 to 600	V
DIAC V_{BO}	33 to 43	V

Description

The Quadrac is an internally triggered Triac designed for AC switching and phase control applications. It is a Triac and DIAC in a single package, which saves user expense by eliminating the need for separate Triac and DIAC components.

Standard type devices normally operate in Quadrants I & III triggered from AC line.

Alternistor type Quadracs are used in circuits requiring high dv/dt capability.

Features & Benefits

- RoHS Compliant
- Glass – passivated junctions
- Voltage capability up to 600 V
- Surge capability up to 200 A

Applications

Excellent for AC switching and phase control applications such as lighting and heating. Typical applications are AC solid-state switches, light dimmers, power tools, home/ brown goods and white goods appliances.

Alternistor Quadracs (no snubber required) are used in applications with extremely inductive loads requiring highest commutation performance.

Internally constructed isolated package is offered for ease of heat sinking with highest isolation voltage.

Additional Information



Datasheet



Resources



Samples

Absolute Maximum Ratings

Symbol	Parameter	Value					Unit	
		Qxx04LT	Qxx06LT / Qxx06LTH	Qxx08LT / Qxx08LTH	Qxx10LT / Qxx10LTH	Qxx15LT / Qxx15LTH		
$I_{T(RMS)}$	RMS forward current	Qxx04LT: $T_C = 95^\circ\text{C}$ Qxx06LT/Qxx08LT/Qxx10LT: $T_C = 90^\circ\text{C}$ Qxx15LT: $T_C = 80^\circ\text{C}$					A	
I_{TSM}	Peak non-repetitive surge current	single half cycle; $f = 50\text{Hz}$; $T_J(\text{initial}) = 25^\circ\text{C}$	46	65	83	100	167	A
		single half cycle; $f = 60\text{Hz}$; $T_J(\text{initial}) = 25^\circ\text{C}$	55	80	100	120	200	
I^2t	I^2t value for fusing	$t_o = 8.3\text{ms}$	12.5	26.5	41	60	166	A^2s
di/dt	Critical rate-of-rise of on-state current	$f = 60\text{Hz}$; $T_J = 125^\circ\text{C}$	50	70		100		$\text{A}/\mu\text{s}$
I_{GM}	Peak gate current	$T_J = 125^\circ\text{C}$	1.5					A
T_{stg}	Storage temperature range		-40 to 150					$^\circ\text{C}$
T_J	Operating junction temperature range		-40 to 125					$^\circ\text{C}$

Note: xx = voltage

Electrical Characteristics ($T_J = 25^\circ\text{C}$, unless otherwise specified) – Standard Quadrac

Symbol	Test Conditions		Value					Unit	
			Qxx04LT	Qxx06LT	Qxx08LT	Qxx10LT	Qxx15LT		
I_H	$I_T = 200\text{mA}$ (initial)	MAX.	40	50	60	60	70	mA	
dv/dt	$V_D = V_{DRM}$; gate open; $T_J = 100^\circ\text{C}$	MIN.	400V	75	150	175	200	300	$\text{V}/\mu\text{s}$
		MIN.	600V	50	125	150	175	200	
dv/dt	$V_D = V_{DRM}$; gate open; $T_J = 125^\circ\text{C}$	MIN.	400V	50	100	120	150	200	$\text{V}/\mu\text{s}$
		MIN.	600V	50	85	100	120	150	
$dv/dt(c)$	$di/dt(c) = 0.54 \times I_{T(RMS)} / \text{ms}$; $T_J = 125^\circ\text{C}$	MIN.	3	4				$\text{V}/\mu\text{s}$	
t_{gt}	(note 1)	TYP.	3					μs	

(1) Reference test circuit in figure 10 and waveform in figure 11; $C_T = 0.1\mu\text{F}$ with 0.1 μs rise time.
Note: xx = voltage

Electrical Characteristics ($T_J = 25^\circ\text{C}$, unless otherwise specified) – Alternistor Quadrac

Symbol	Test Conditions		Value				Unit	
			Qxx06LTH	Qxx08LTH	Qxx10LTH	Qxx15LTH		
I_H	$I_T = 20\text{mA}$ (initial)	MAX.	50	50	60	70	mA	
dv/dt	$V_D = V_{DRM}$; gate open; $T_J = 100^\circ\text{C}$	MIN.	400V	575		925		$\text{V}/\mu\text{s}$
		MIN.	600V	425		775		
dv/dt	$V_D = V_{DRM}$; gate open; $T_J = 125^\circ\text{C}$	MIN.	400V	450		700		$\text{V}/\mu\text{s}$
		MIN.	600V	350		600		
$dv/dt(c)$	$di/dt(c) = 0.54 \times I_{T(RMS)} / \text{ms}$; $T_J = 125^\circ\text{C}$	MIN.	25		30		$\text{V}/\mu\text{s}$	
t_{gt}	(note 1)	TYP.	3				μs	

(1) Reference test circuit in figure 10 and waveform in figure 11; $C_T = 0.1\mu\text{F}$ with 0.1 μs rise time.
Note: xx = voltage

Trigger DIAC Specifications

Symbol	Test Conditions		Value	Unit
ΔV_{BO}	Breakover Voltage Symmetry	MAX.	3	V
V_{BO}	Breakover Voltage, forward and reverse	MIN.	33	V
		MAX.	43	
$[\Delta V_{\pm}]$	Dynamic Breakback Voltage, forward and reverse (note 1)	MIN.	5	V
I_{BO}	Peak Breakover Current	MAX.	25	μA
C_T	Trigger Firing Capacitance	MAX.	0.1	μF

(1) Reference test circuit in figure 10 and waveform in figure 11.

Static Characteristics

Symbol	Test Conditions		Value	Unit
V_{TM}	$I_T = 1.41 \times I_{T(rms)} A; t_p = 380\mu s$	MAX.	1.6	V
I_{DRM} / I_{RRM}	V_{DRM} / V_{RRM}	$T_J = 25^\circ C$	MAX.	10
		$T_J = 100^\circ C$		500
		$T_J = 125^\circ C$		2000

Thermal Resistances

Symbol	Parameter		Value	Unit
$R_{\theta(J-C)}$	Junction to case (AC)	Qxx04LT	3.6	$^\circ C/W$
		Qxx06LT / Qxx06LTH	3.3	
		Qxx08LT / Qxx08LTH	2.8	
		Qxx10LT / Qxx10LTH	2.6	
		Qxx15LT / Qxx15LTH	2.1	
$R_{\theta(J-A)}$	Junction to ambient		50	$^\circ C/W$

Note : xx = voltage

Figure 1: Normalized DC Holding Current vs. Junction Temperature

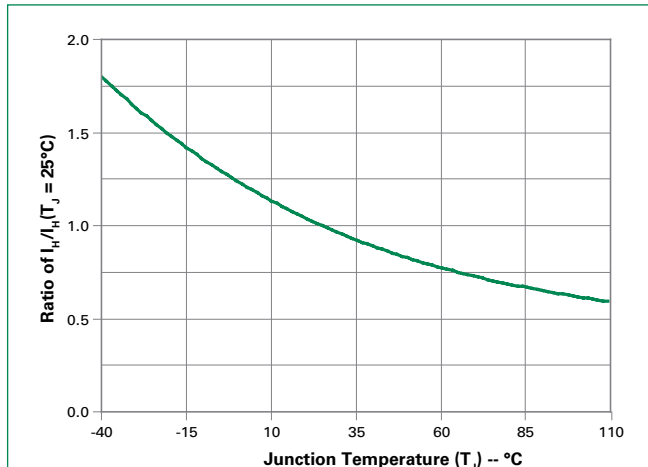

Figure 2: On-State Current vs. On-State Voltage (Typical) (4A)

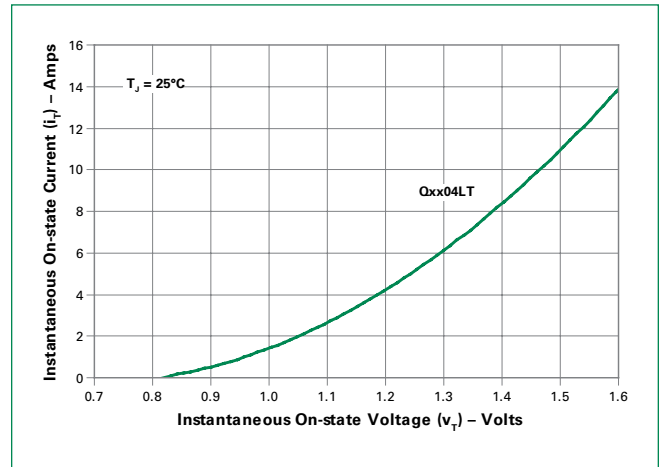

Figure 3: On-State Current vs. On-State Voltage (Typical) (6A to 15A)

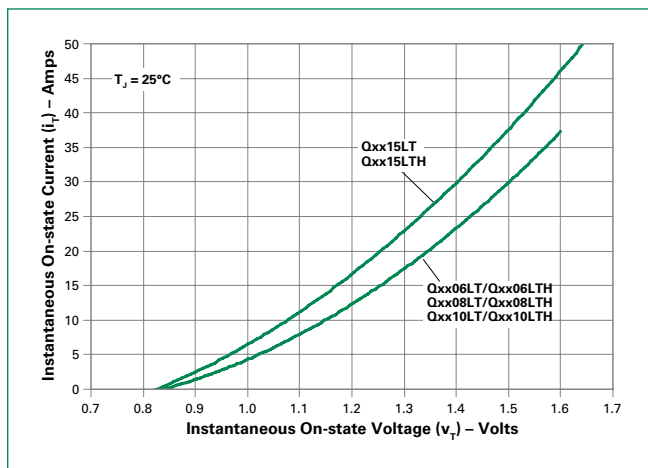

Figure 4: Power Dissipation vs. RMS On-State Current (Typical) (4A)

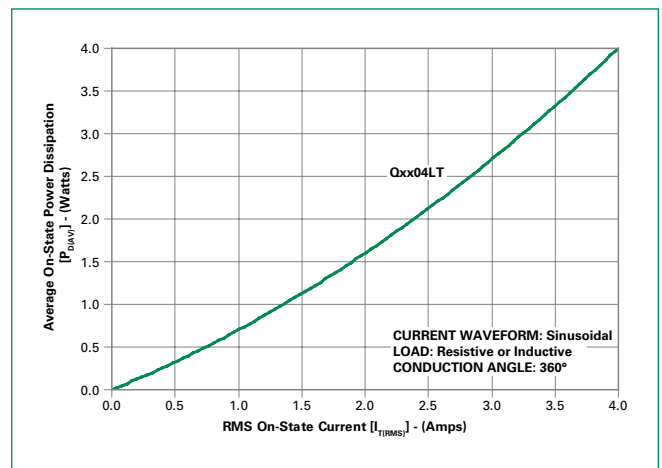

Figure 5: Power Dissipation vs. RMS On-State Current (Typical) (6A to 15A)

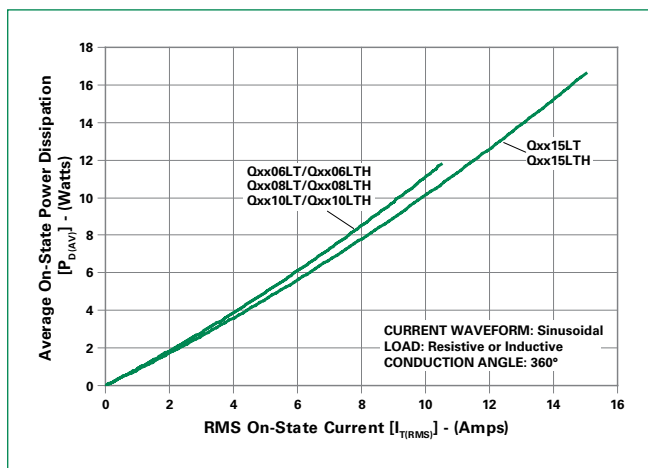

Figure 6: Maximum Allowable Case Temperature vs. RMS On-State Current

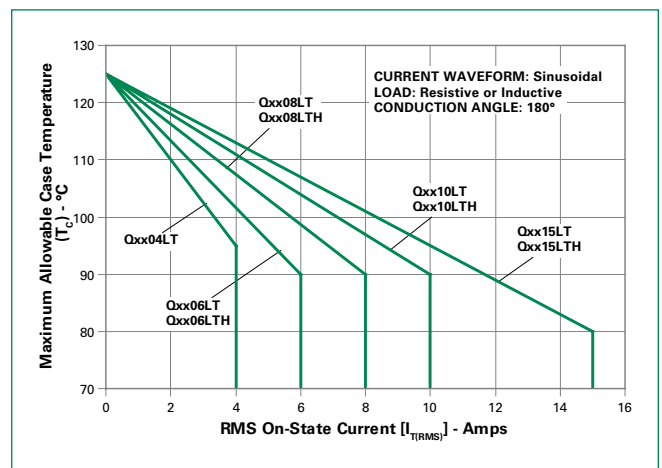
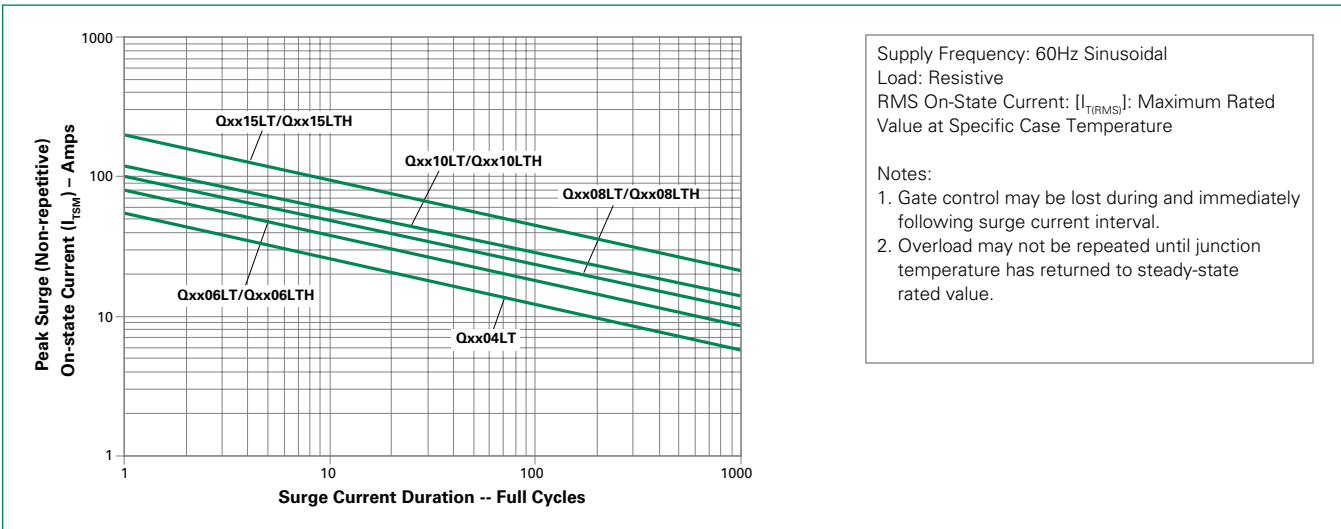

Figure 7: Surge Peak On-State Current vs. Number of Cycles



Note: xx = voltage

Figure 8: DIAC V_{BO} Change vs. Junction Temperature

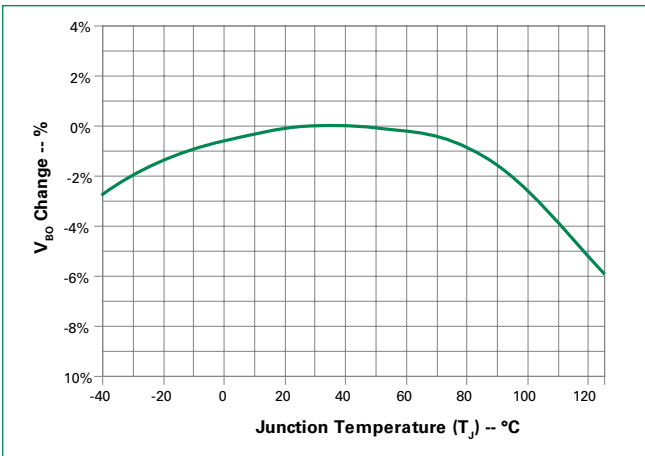

Figure 9: Test Circuit

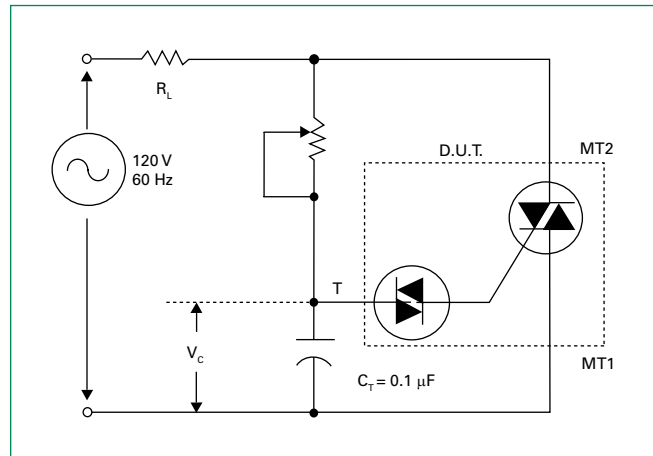

Figure 10: Test Circuit Waveform

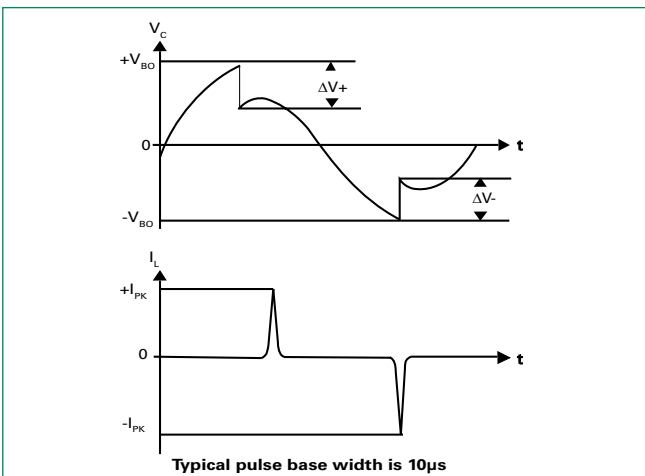
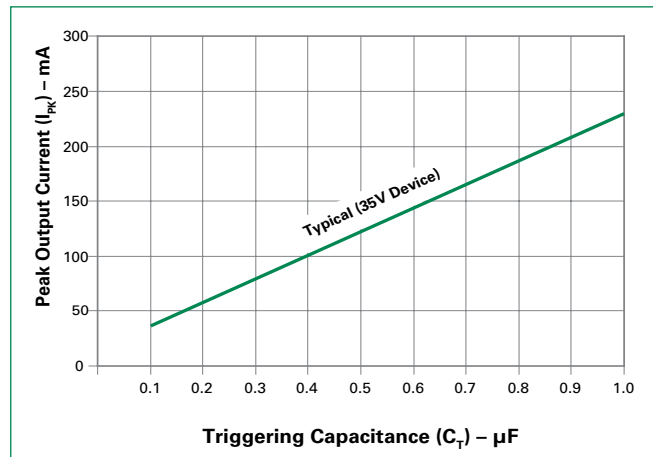
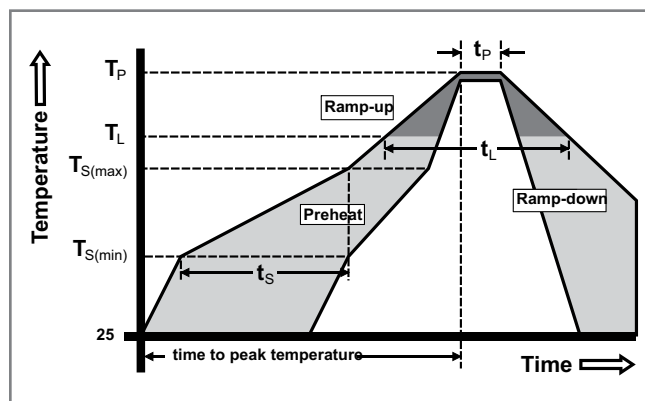

Figure 11: Peak Output Current vs Triggering Capacitance (Per Figure 9)



Soldering Parameters

Reflow Condition		Pb – Free assembly
Pre Heat	- Temperature Min ($T_{s(min)}$)	150°C
	- Temperature Max ($T_{s(max)}$)	200°C
	- Time (min to max) (t_s)	60 – 180 secs
Average ramp up rate (Liquidus Temp) (T_L) to peak		5°C/second max
$T_{s(max)}$ to T_L - Ramp-up Rate		5°C/second max
Reflow	- Temperature (T_L) (Liquidus)	217°C
	- Temperature (t_L)	60 – 150 seconds
Peak Temperature (T_p)		260 ^{+0/-5} °C
Time within 5°C of actual peak Temperature (t_p)		20 – 40 seconds
Ramp-down Rate		5°C/second max
Time 25°C to peak Temperature (T_p)		8 minutes Max.
Do not exceed		280°C



Physical Specifications

Terminal Finish	1005 Matte Tin-plated
Body Material	UL Recognized epoxy meeting flammability classification 94v-0
Lead Material	Copper Alloy

Design Considerations

Careful selection of the correct device for the application's operating parameters and environment will go a long way toward extending the operating life of the Thyristor. Good design practice should limit the maximum continuous current through the main terminals to 75% of the device rating. Other ways to ensure long life for a power discrete semiconductor are proper heat sinking and selection of voltage ratings for worst case conditions. Overheating, overvoltage (including dv/dt), and surge currents are the main killers of semiconductors. Correct mounting, soldering, and forming of the leads also help protect against component damage.

Environmental Specifications

Test	Specifications and Conditions
High Temperature Voltage Blocking	MIL-STD-750: Method 1040, Condition A Rated V_{DRM} (VAC-peak), 125°C, 1008 hours
Temperature Cycling	MIL-STD-750: Method 1051 -40°C to 150°C, 15-minute dwell, 100 cycles
Biased Temperature & Humidity	EIA/JEDEC: JESD22-A101 320VDC, 85°C, 85%RH, 1008 hours
High Temp Storage	MIL-STD-750: Method 1031 150°C, 1008 hours
Low-Temp Storage	-40°C, 1008 hours
Thermal Shock	MIL-STD-750: Method 1056 0°C to 100°C, 5-minute dwell, 10-second transfer, 10 cycles
Autoclave (Pressure Cooker Test)	EIA/JEDEC: JESD22-A102 121°C, 100%RH, 2atm, 168 hours
Resistance to Solder Heat	MIL-STD-750: Method 2031 260°C, 10 seconds
Solderability	ANSI/J-STD-002, Category 3, Test A
Lead Bend	MIL-STD-750: Method 2036, Condition E

Dimensions — TO-220AB (L-Package) — Isolated Mounting Tab

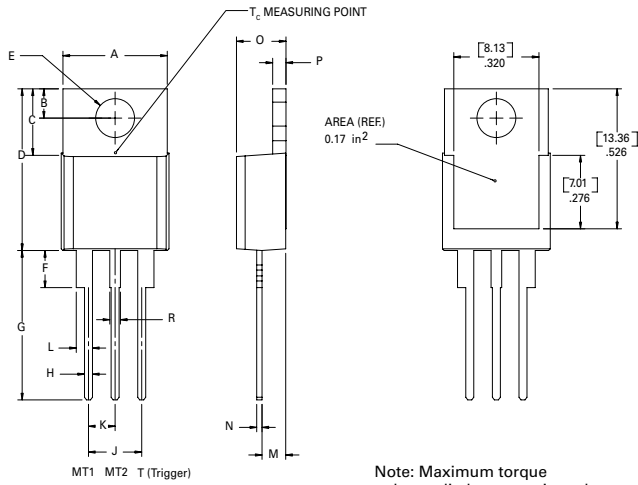

Note: Maximum torque to be applied to mounting tab is 8 in-lbs. (0.904 Nm).

Dimension	Inches		Millimeters	
	Min	Max	Min	Max
A	0.380	0.420	9.65	10.67
B	0.105	0.115	2.67	2.92
C	0.230	0.250	5.84	6.35
D	0.590	0.620	14.99	15.75
E	0.142	0.147	3.61	3.73
F	0.110	0.130	2.79	3.30
G	0.540	0.575	13.72	14.61
H	0.025	0.035	0.64	0.89
J	0.195	0.205	4.95	5.21
K	0.095	0.105	2.41	2.67
L	0.060	0.075	1.52	1.91
M	0.085	0.095	2.16	2.41
N	0.018	0.024	0.46	0.61
O	0.178	0.188	4.52	4.78
P	0.045	0.060	1.14	1.52
R	0.038	0.048	0.97	1.22

Product Selector

Part Number	Voltage				Type	Package
	400V	600V	800V	1000V		
Qxx04LT	X	X			Quadrac	TO-220L
Qxx06LT	X	X			Quadrac	TO-220L
Qxx06LTH	X	X			Alternistor Quadrac	TO-220L
Qxx08LT	X	X			Quadrac	TO-220L
Qxx08LTH	X	X			Alternistor Quadrac	TO-220L
Qxx10LT	X	X			Quadrac	TO-220L
Qxx10LTH	X	X			Alternistor Quadrac	TO-220L
Qxx15LT	X	X			Quadrac	TO-220L
Qxx15LTH	X	X			Alternistor Quadrac	TO-220L

Note: xx = Voltage