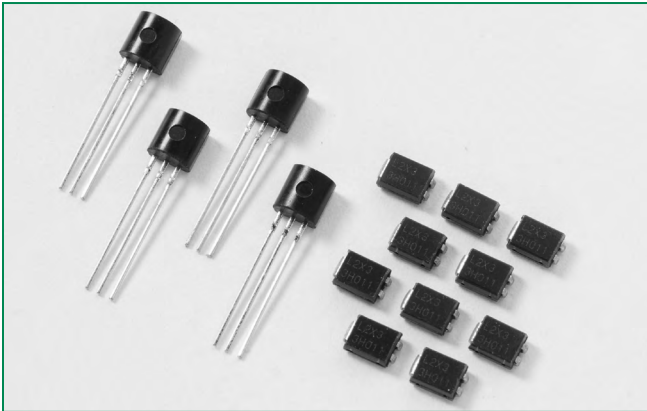


Lx01Ex & LxNx & Qx01Ex & QxNx Series

RoHS



**Description**

1 Amp bi-directional solid state switch series is designed for AC switching and phase control applications such as motor speed and temperature modulation controls, lighting controls, and static switching relays.

**Sensitive** type devices guarantee gate control in Quadrants I & IV needed for digital control circuitry.

**Standard** type devices normally operate in Quadrants I & III triggered from AC line.

**Features & Benefits**

- RoHS Compliant
- Glass – passivated junctions
- Voltage capability up to 600 V
- Surge capability up to 20 A

**Applications**

Excellent for lower current heating controls, water valves, and solenoids.

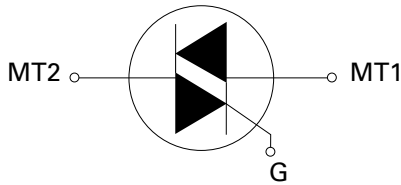
Typical applications are AC solid-state switches, home/brown goods and white goods appliances.

Sensitive gate Triacs can be directly driven by microprocessor or popular opto-couplers/isolators.

**Main Features**

Symbol	Value	Unit
$I_{T(RMS)}$	1	A
$V_{DRM}/V_{RRM}$	400 to 600	V
$I_{GT(Q1)}$	3 to 25	mA

**Schematic Symbol**



**Additional Information**



Datasheet



Resources



Samples

**Absolute Maximum Ratings – Sensitive Triacs (4 Quadrants)**

Symbol	Parameter	Value	Unit
$I_{T(RMS)}$	RMS on-state current (full sine wave)	Lx01Ey/LxNy $T_c = 50^\circ\text{C}$	1 A
$I_{TSM}$	Non repetitive surge peak on-state current (full cycle, $T_j$ initial = $25^\circ\text{C}$ )	f = 50 Hz t = 20 ms	16.7
		f = 60 Hz t = 16.7 ms	20
$I^2t$	$I^2t$ Value for fusing	$t_p = 8.3$ ms	1.6 $\text{A}^2\text{s}$
di/dt	Critical rate of rise of on-state current ( $I_G = 50\text{mA}$ with $\leq 0.1\mu\text{s}$ rise time)	f = 120 Hz $T_j = 110^\circ\text{C}$	20 $\text{A}/\mu\text{s}$
$I_{GTM}$	Peak gate trigger current	$t_p \leq 10$ $\mu\text{s}$ $T_j = 110^\circ\text{C}$	1 A
$P_{G(AV)}$	Average gate power dissipation	$T_j = 110^\circ\text{C}$	0.2 W
$T_{stg}$	Storage temperature range	Lx01Ey	-65 to 150
		LxNy	-40 to 125
$T_j$	Operating junction temperature range	Lx01Ey	-65 to 110
		LxNy	-40 to 110

Note: x = voltage, y = sensitivity

**Absolute Maximum Ratings — Standard Triacs**

Symbol	Parameter			Value	Unit
$I_{T(RMS)}$	RMS on-state current (full sine wave)	Qx01Ey/QxNy	$T_C = 60^\circ\text{C}$	1	A
$I_{TSM}$	Non repetitive surge peak on-state current (full cycle, $T_J$ initial = $25^\circ\text{C}$ )	f = 50 Hz	t = 20 ms	16.7	A
		f = 60 Hz	t = 16.7 ms	20	
$I^2t$	$I^2t$ Value for fusing	$t_p = 8.3$ ms		1.6	A <sup>2</sup> s
di/dt	Critical rate of rise of on-state current ( $I_G = 200\text{mA}$ with $\leq 0.1\mu\text{s}$ rise time)	f = 120 Hz	$T_J = 125^\circ\text{C}$	20	A/ $\mu\text{s}$
$I_{GTM}$	Peak gate trigger current	$t_p \leq 10 \mu\text{s};$ $I_{GT} \leq I_{GTM}$	$T_J = 125^\circ\text{C}$	1	A
$P_{G(AV)}$	Average gate power dissipation	$T_J = 125^\circ\text{C}$		0.2	W
$T_{stg}$	Storage temperature range	Qx01Ey		-65 to 150	°C
		QxNy		-40 to 150	
$T_J$	Operating junction temperature range	Qx01Ey		-65 to 125	°C
		QxNy		-40 to 125	

Note: x = voltage, y = sensitivity

**Electrical Characteristics ( $T_J = 25^\circ\text{C}$ , unless otherwise specified) — Sensitive Triac (4 Quadrants)**

Symbol	Test Conditions	Quadrant		Lx01E3 LxN3	Lx01E5 LxN5	Lx01E6 LxN6	Lx01E8 LxN8	Unit
		I – II – III	IV					
$I_{GT}$	$V_D = 12\text{V}$ $R_L = 60 \Omega$	I – II – III	MAX.	3	5	5	10	mA
		IV		3	5	10	20	
$V_{GT}$	$V_D = 12\text{V}$ $R_L = 60 \Omega$	ALL	MAX.	1.3				V
$V_{GD}$	$V_D = V_{DRM}$ $R_L = 3.3 \text{k}\Omega$ $T_J = 110^\circ\text{C}$	ALL	MIN.	0.2				V
$I_H$	$I_T = 100\text{mA}$		MAX.	5	10	10	15	mA
dv/dt	$V_D = V_{DRM}$ Gate Open $T_J = 100^\circ\text{C}$	400V	TYP.	20	20	30	35	V/ $\mu\text{s}$
		600V		10	10	20	25	
(dv/dt)c	(di/dt)c = 0.54 A/ms $T_J = 110^\circ\text{C}$		TYP.	0.5	1	1	1	V/ $\mu\text{s}$
$t_{gt}$	$I_G = 2 \times I_{GT}$ PW = 15 $\mu\text{s}$ $I_T = 1.41$ A(pk)		TYP.	2.8	3.0	3.0	3.2	$\mu\text{s}$

**Electrical Characteristics ( $T_J = 25^\circ\text{C}$ , unless otherwise specified) — Standard Triac**

Symbol	Test Conditions	Quadrant		Qx01E3 QxN3	Qx01E4 QxN4	Unit
		I – II – III	IV			
$I_{GT}$	$V_D = 12\text{V}$ $R_L = 60 \Omega$	I – II – III	MAX.	10	25	mA
		IV	TYP.	25	50	
$V_{GT}$	$V_D = 12\text{V}$ $R_L = 60 \Omega$	I – II – III	MAX.	1.3	1.3	V
$V_{GD}$	$V_D = V_{DRM}$ $R_L = 3.3 \text{k}\Omega$ $T_J = 125^\circ\text{C}$	ALL	MIN.	0.2	0.2	V
$I_H$	$I_T = 200\text{mA}$		MAX.	15	25	mA
dv/dt	$V_D = V_{DRM}$ Gate Open $T_J = 125^\circ\text{C}$	400V	MIN.	30	40	V/ $\mu\text{s}$
		600V		20	30	
(dv/dt)c	(di/dt)c = 0.54 A/ms $T_J = 125^\circ\text{C}$		TYP.	1	1	V/ $\mu\text{s}$
$t_{gt}$	$I_G = 2 \times I_{GT}$ PW = 15 $\mu\text{s}$ $I_T = 1.41$ A(pk)		TYP.	2.5	3.0	$\mu\text{s}$

Note: x = voltage, y = sensitivity

**Static Characteristics ( $T_J = 25^\circ\text{C}$ , unless otherwise specified)**

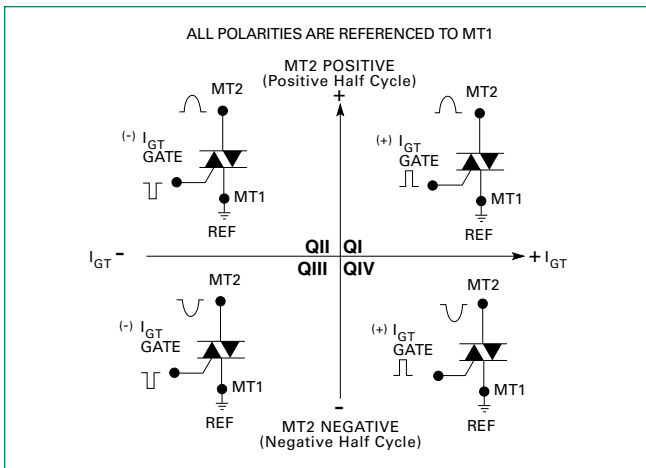
Symbol	Test Conditions	Value	Unit	
$V_{TM}$	$I_{TM} = 1.41\text{A}$ $t_p = 380\ \mu\text{s}$	MAX.	1.60 V	
$I_{DRM}$ $I_{RRM}$	$V_{DRM} = V_{RRM}$	MAX.	Lx01Ey / LxNy	
			$T_J = 25^\circ\text{C}$ 400-600V	2 $\mu\text{A}$
			$T_J = 110^\circ\text{C}$ 400-600V	0.1 mA
			Qx01Ey / QxNy	
$T_J = 25^\circ\text{C}$ 400-600V	5 $\mu\text{A}$			
$T_J = 125^\circ\text{C}$ 400-600V	1 mA			

**Thermal Resistances**

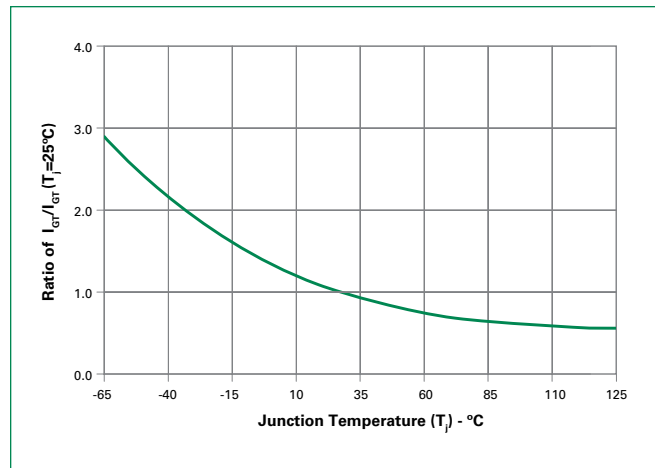
Symbol	Parameter	Value	Unit
$R_{\theta(J-C)}$	Junction to case (AC)	L/Qx01Ey	50
		L/QxNy	40*
$R_{\theta(J-A)}$	Junction to ambient	L/Qx01Ey	95

Note: \* = Mounted on 1 cm<sup>2</sup> copper (two-ounce) foil surface

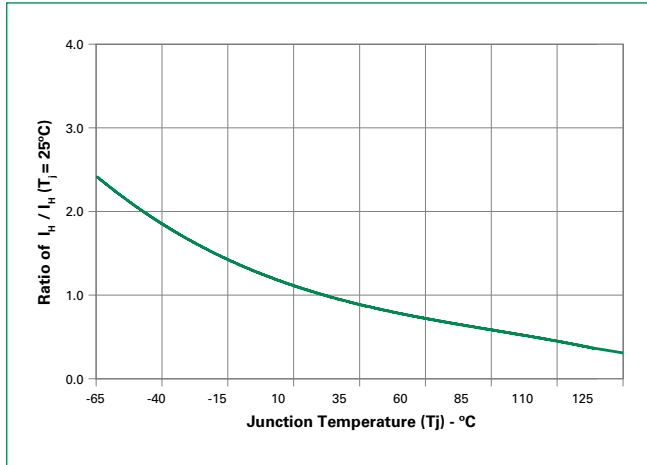
**Figure 1: Definition of Quadrants**



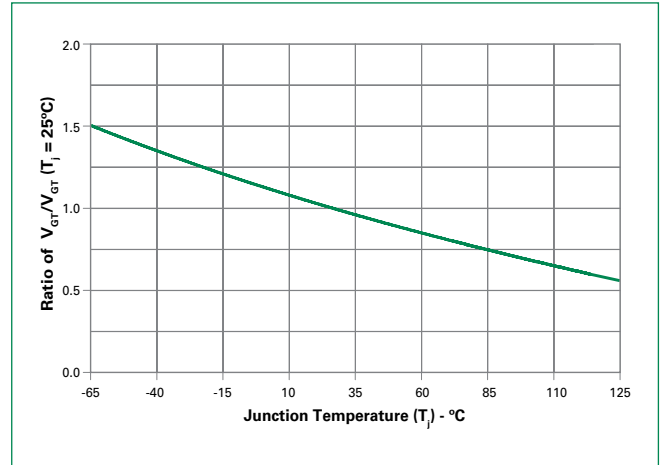
**Figure 2: Normalized DC Gate Trigger Current for All Quadrants vs. Junction Temperature**



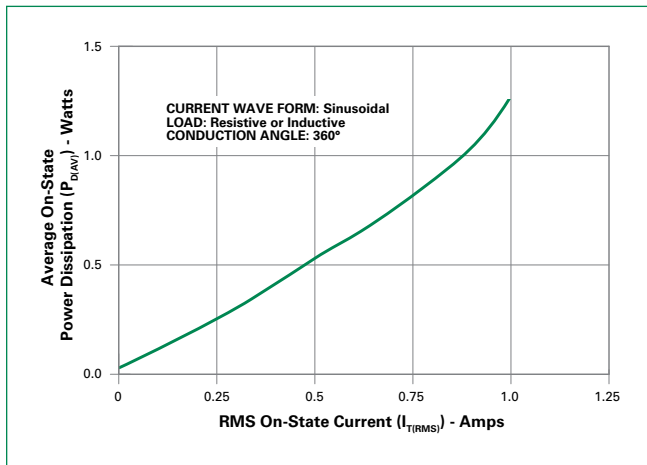
**Figure 3: Normalized DC Holding Current vs. Junction Temperature**



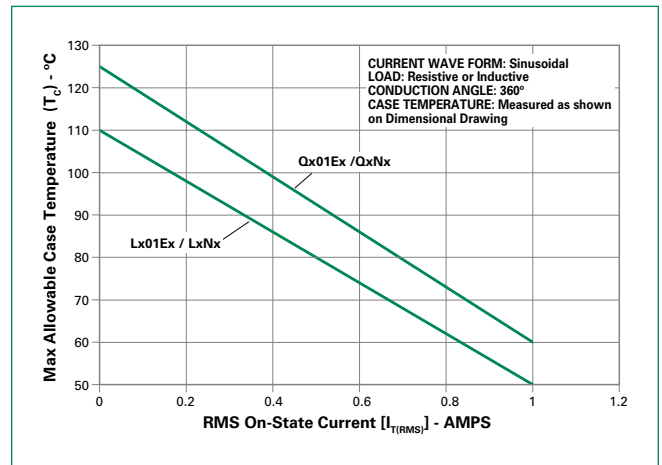
**Figure 4: Normalized DC Gate Trigger Voltage for All Quadrants vs. Junction Temperature**



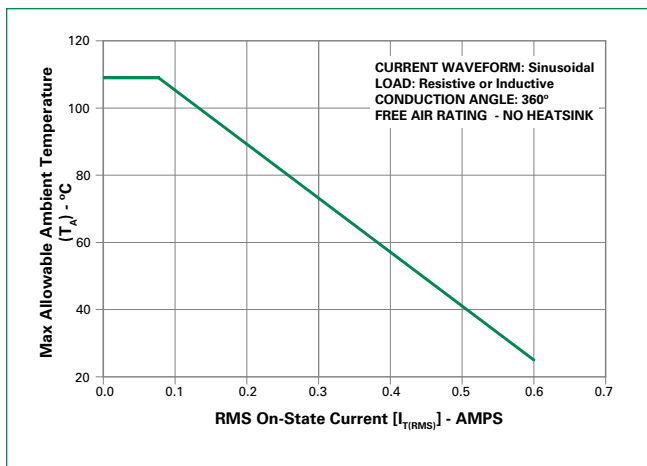
**Figure 5: Power Dissipation (Typical) vs. RMS On-State Current**



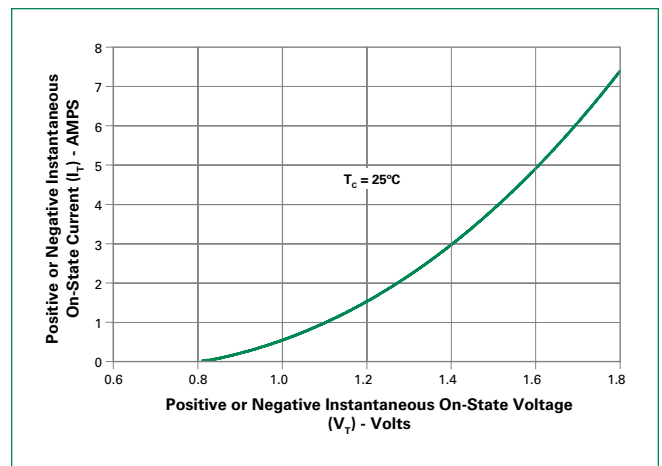
**Figure 6: Maximum Allowable Case Temperature vs. On-State Current**



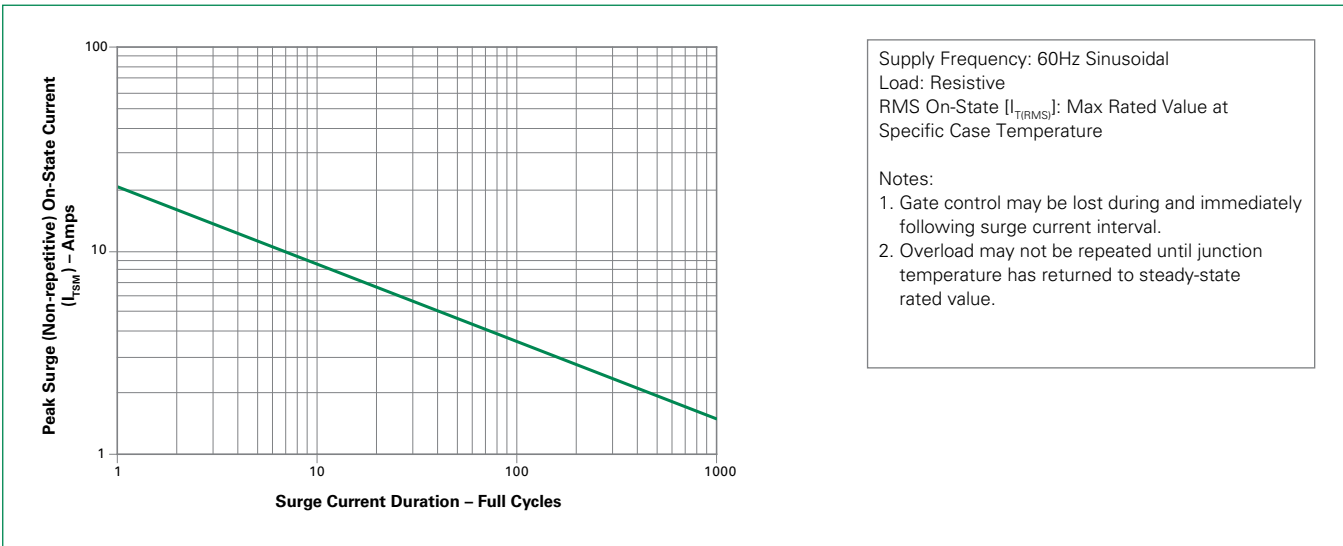
**Figure 7: Maximum Allowable Ambient Temperature vs. On-State Current**



**Figure 8: On-State Current vs. On-State Voltage (Typical)**

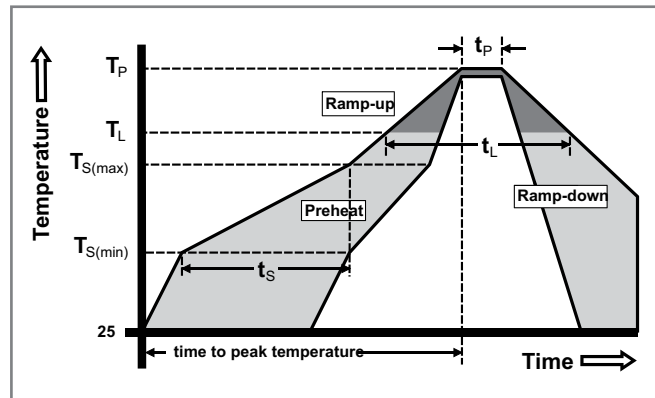


**Figure 9: Surge Peak On-State Current vs. Number of Cycles**



**Soldering Parameters**

Reflow Condition		Pb – Free assembly
Pre Heat	- Temperature Min ( $T_{s(min)}$ )	150°C
	- Temperature Max ( $T_{s(max)}$ )	200°C
	- Time (min to max) ( $t_s$ )	60 – 180 secs
Average ramp up rate (Liquidus Temp) ( $T_L$ ) to peak		5°C/second max
$T_{s(max)}$ to $T_L$ - Ramp-up Rate		5°C/second max
Reflow	- Temperature ( $T_L$ ) (Liquidus)	217°C
	- Temperature ( $t_L$ )	60 – 150 seconds
Peak Temperature ( $T_p$ )		260 <sup>+0/-5</sup> °C
Time within 5°C of actual peak Temperature ( $t_p$ )		20 – 40 seconds
Ramp-down Rate		5°C/second max
Time 25°C to peak Temperature ( $T_p$ )		8 minutes Max.
Do not exceed		280°C



### Physical Specifications

<b>Terminal Finish</b>	100% Matte Tin-plated
<b>Body Material</b>	UL recognized epoxy meeting flammability classification 94V-0
<b>Terminal Material</b>	Copper Alloy

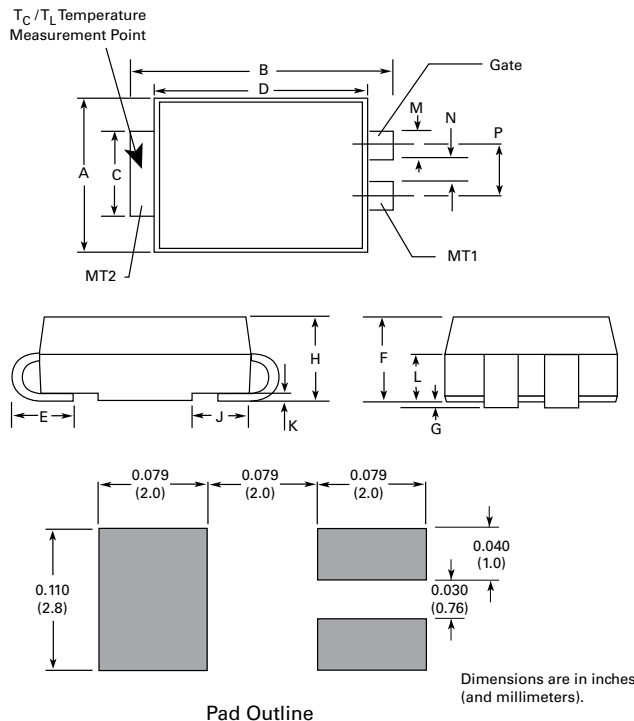
### Design Considerations

Careful selection of the correct device for the application's operating parameters and environment will go a long way toward extending the operating life of the Thyristor. Good design practice should limit the maximum continuous current through the main terminals to 75% of the device rating. Other ways to ensure long life for a power discrete semiconductor are proper heat sinking and selection of voltage ratings for worst case conditions. Overheating, overvoltage (including dv/dt), and surge currents are the main killers of semiconductors. Correct mounting, soldering, and forming of the leads also help protect against component damage.

### Environmental Specifications

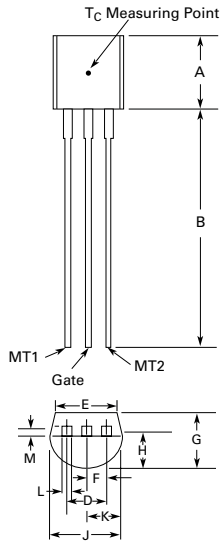
Test	Specifications and Conditions
<b>AC Blocking</b>	MIL-STD-750, M-1040, Cond A Applied Peak AC voltage @ 125°C for 1008 hours
<b>Temperature Cycling</b>	MIL-STD-750, M-1051, 100 cycles; -40°C to +150°C; 15-min dwell time
<b>Temperature/Humidity</b>	EIA / JEDEC, JESD22-A101 1008 hours; 320V - DC: 85°C; 85% rel humidity
<b>High Temp Storage</b>	MIL-STD-750, M-1031, 1008 hours; 150°C
<b>Low-Temp Storage</b>	1008 hours; -40°C
<b>Resistance to Solder Heat</b>	MIL-STD-750 Method 2031
<b>Solderability</b>	ANSI/J-STD-002, category 3, Test A
<b>Lead Bend</b>	MIL-STD-750, M-2036 Cond E

### Dimensions - Compak (C Package)



Dimension	Inches		Millimeters	
	Min	Max	Min	Max
A	0.130	0.156	3.30	3.95
B	0.201	0.220	5.10	5.60
C	0.077	0.087	1.95	2.20
D	0.159	0.181	4.05	4.60
E	0.030	0.063	0.75	1.60
F	0.075	0.096	1.90	2.45
G	0.002	0.008	0.05	0.20
H	0.077	0.104	1.95	2.65
J	0.043	0.053	1.09	1.35
K	0.006	0.016	0.15	0.41
L	0.030	0.055	0.76	1.40
M	0.022	0.028	0.56	0.71
N	0.027	0.033	0.69	0.84
P	0.052	0.058	1.32	1.47

### Dimensions - TO-92 (E Package)



Dimension	Inches		Millimeters	
	Min	Max	Min	Max
A	0.176	0.196	4.47	4.98
B	0.500	-	12.70	-
D	0.095	0.105	2.41	2.67
E	0.150	-	3.81	-
F	0.046	0.054	1.16	1.37
G	0.135	0.145	3.43	3.68
H	0.088	0.096	2.23	2.44
J	0.176	0.186	4.47	4.73
K	0.088	0.096	2.23	2.44
L	0.013	0.019	0.33	0.48
M	0.013	0.017	0.33	0.43

All leads insulated from case. Case is electrically nonconductive.

### Product Selector

Part Number	Voltage		Gate Sensitivity Quadrants		Type	Package
	400V	600V	I – II – III	IV		
Lx01E3	X	X	3 mA	3 mA	Sensitive Triac	TO-92
LxN3	X	X	3 mA	3 mA	Sensitive Triac	Compak
Lx01E5	X	X	5 mA	5 mA	Sensitive Triac	TO-92
LxN5	X	X	5 mA	5 mA	Sensitive Triac	Compak
Lx01E6	X	X	5 mA	10 mA	Sensitive Triac	TO-92
Lx01E8	X	X	10 mA	20 mA	Sensitive Triac	TO-92
Qx01E3	X	X	10 mA		Standard Triac	TO-92
QxN3	X	X	10 mA		Standard Triac	Compak
Qx01E4	X	X	25 mA		Standard Triac	TO-92
QxN4	X	X	25 mA		Standard Triac	Compak

Note: x- voltage

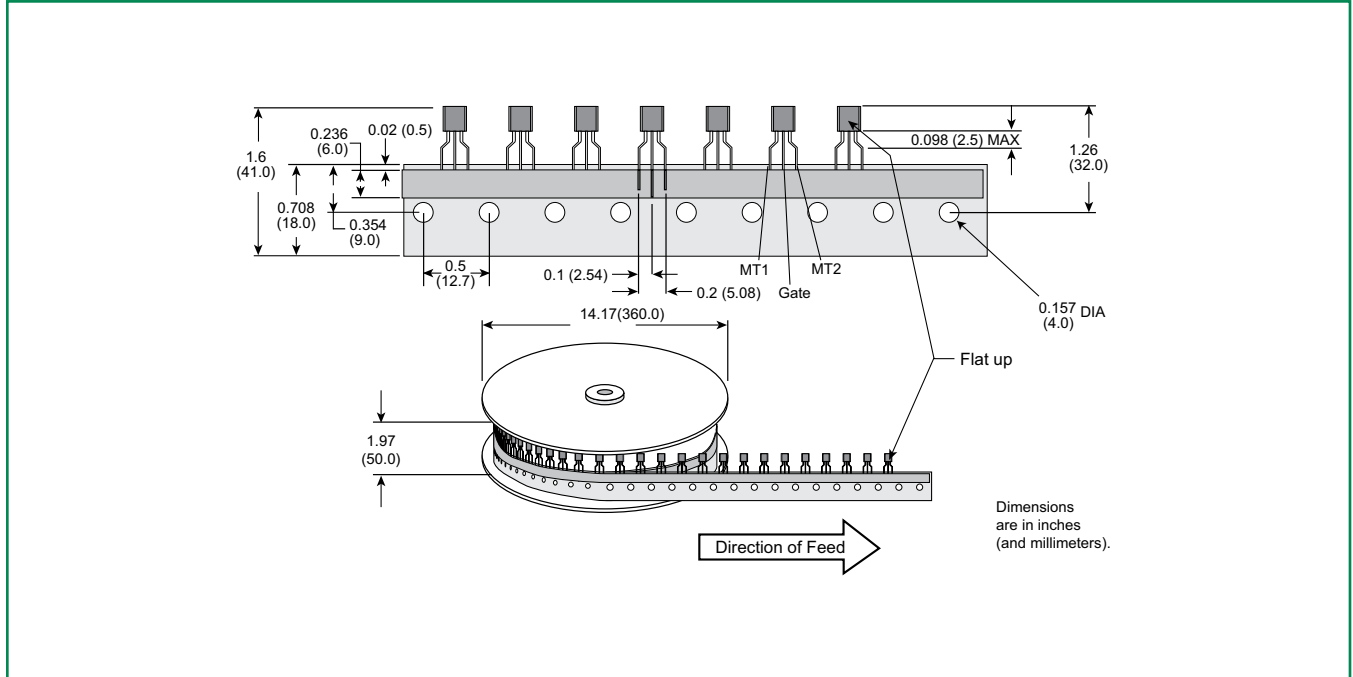
### Packing Options

Part Number	Marking	Weight	Packing Mode	Base Quantity
L/Qx01Ey	L/Qx01Ey	0.188 g	Bulk	2000
L/Qx01EyRP	L/Qx01Ey	0.188 g	Reel Pack	2000
L/Qx01EyAP	L/Qx01Ey	0.188 g	Ammo Pack	2000
L/QxNyRP	L/QxNy	0.081 g	Embossed Carrier	2500

Note: x = Voltage; y = Sensitivity

**TO-92 (3-lead) Reel Pack (RP) Radial Ledged**

Meets all EIA-468-C Standards



**TO-92 (3-lead) Ammo Pack (AP) Radial Ledged**

Meets all EIA-468-C Standards

