

## Quick Start Guide

Class 1 laser CMOS sensor with a discrete (PNP or NPN) output. Patent pending.

This guide is designed to help you set up and install the Q4X Sensor. For complete information on programming, performance, troubleshooting, dimensions, and accessories, please refer to the Instruction Manual at [www.bannerengineering.com](http://www.bannerengineering.com). Search for p/n 181483 to view the Instruction Manual. Use of this document assumes familiarity with pertinent industry standards and practices.

For illustration purposes, the threaded barrel model Q4X images are used throughout this document.



### WARNING:

- **Do not use this device for personnel protection**
- Using this device for personnel protection could result in serious injury or death.
- This device does not include the self-checking redundant circuitry necessary to allow its use in personnel safety applications. A device failure or malfunction can cause either an energized (on) or de-energized (off) output condition.

## Features

Figure 1. Sensor Features—Threaded Barrel Models

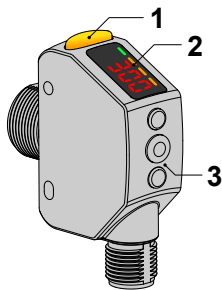

1. Output Indicator (Amber)
2. Display
3. Buttons

Figure 2. Sensor Features—Flush Mount Models

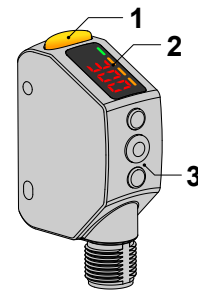

## Display and Indicators

The display is a 4-digit, 7-segment LED. The main screen is the Run mode screen.

For 2-pt, BGS, FGS, and DYN TEACH modes, the display shows the current distance to the target in millimeters. For dual TEACH mode, the display shows the percentage matched to the taught reference surface. A display value of **9999** indicates the sensor has not been taught.

Figure 3. Display in Run Mode



1. Stability Indicator (STB—Green)
2. Active TEACH Indicators
  - DYN—Dynamic (Amber)
  - FGS—Foreground Suppression (Amber)
  - BGS—Background Suppression (Amber)

### Output Indicator

- On—Outputs conducting (closed)
- Off—Outputs not conducting (open)

### Stability Indicator (STB)

- On—Stable signal within the specified sensing range
- Flashing—Marginal signal, the target is outside the limits of the specified sensing range, or a multiple peak condition exists
- Off—No target detected within the specified sensing range

### Active TEACH Indicators (DYN, FGS, and BGS)

- DYN, FGS, and BGS all off—Two-point TEACH mode selected (default)
- DYN on—Dynamic TEACH mode selected
- FGS on—Foreground suppression TEACH mode selected
- BGS on—Background suppression TEACH mode selected
- DYN, FGS, and BGS all on—Dual TEACH mode selected

## Buttons

Use the sensor buttons **(SELECT)(TEACH)**, **(+)(DISP)**, and **(-)(MODE)** to program the sensor.



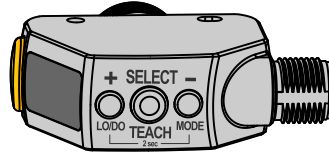

**(SELECT)(TEACH)**

- Press to select menu items in Setup mode
- Press and hold for longer than 2 seconds to start the currently selected TEACH mode (the default is two-point TEACH)

**(+)(DISP)**

- Press to navigate the sensor menu in Setup mode
- Press to change setting values; press and hold to increase numeric values
- Press and hold for longer than 2 seconds to switch between light operate (LO) and dark operate (DO)

**(-)(MODE)**

- Press to navigate the sensor menu in Setup mode
- Press to change setting values; press and hold to decrease numeric values
- Press and hold for longer than 2 seconds to enter Setup mode



**Note:** When navigating the menu, the menu items loop.

Laser Description and Safety Information



**CAUTION:**

- Return defective units to the manufacturer.
- Use of controls or adjustments or performance of procedures other than those specified herein may result in hazardous radiation exposure.
- Do not attempt to disassemble this sensor for repair. A defective unit must be returned to the manufacturer.

**≤ 510 mm Models - IEC 60825-1:2007 Class 1 Laser**

Class 1 lasers are lasers that are safe under reasonably foreseeable conditions of operation, including the use of optical instruments for intrabeam viewing.

COMPLIES WITH 21 CFR 1040.10 AND 1040.11 EXCEPT FOR DEVIATIONS PURSUANT TO LASER NOTICE No. 50, DATED JUNE 24, 2007.  BANNER ENGINEERING CORP. 9714 10TH AVENUE NORTH MINNEAPOLIS, MN 55441	<div style="border: 2px solid black; padding: 5px; width: fit-content; margin: 0 auto;">                     CLASS 1                      LASER PRODUCT                 </div> COMPLIES WITH IEC 60825-1:2007
---	---

**Laser wavelength:** 655 nm

**Output:** < 0.20 mW

**Pulse Duration:** 7 μs to 2 ms

**> 510 mm Models - IEC 60825-1:2014 Class 1 Laser**

Class 1 lasers are lasers that are safe under reasonably foreseeable conditions of operation, including the use of optical instruments for intrabeam viewing.

COMPLIES WITH 21 CFR 1040.10 AND 1040.11 EXCEPT FOR CONFORMANCE WITH IEC 60825-1:2014, AS DESCRIBED IN LASER NOTICE No. 56, DATED MAY 8, 2019.  BANNER ENGINEERING CORP. 9714 10TH AVENUE NORTH MINNEAPOLIS, MN 55441	<div style="border: 2px solid black; padding: 5px; width: fit-content; margin: 0 auto;">                     CLASS 1                      LASER PRODUCT                 </div> COMPLIES WITH IEC 60825-1:2014
--	---

**Laser wavelength:** 655 nm

**Output:** < 0.39 mW

**Pulse Duration:** 7 μs to 2 ms

## Installation

### Install the Safety Label

The safety label must be installed on Q4X sensors that are used in the United States.



**Note:** Position the label on the cable in a location that has minimal chemical exposure.

1. Remove the protective cover from the adhesive on the label.
2. Wrap the label around the Q4X cable, as shown.
3. Press the two halves of the label together.

Figure 4. Safety Label Installation

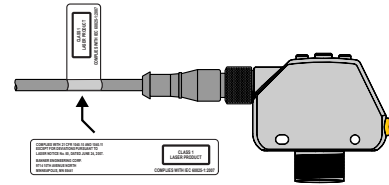

### Sensor Orientation

Optimize detection reliability and minimum object separation performance with correct sensor-to-target orientation. To ensure reliable detection, orient the sensor as shown in relation to the target to be detected.

Figure 5. Optimal Orientation of Target to Sensor

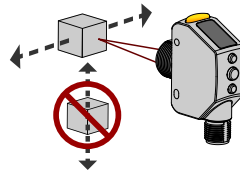

See the following figures for examples of correct and incorrect sensor-to-target orientation as certain placements may pose problems for sensing some targets. The Q4X can be used in the less preferred orientation and provide reliable detection performance; refer to the *Performance Curves* for the minimum object separation distance required for each case.

Figure 6. Orientation by a wall

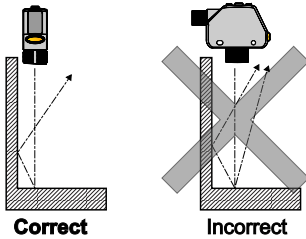

Figure 7. Orientation for a turning object

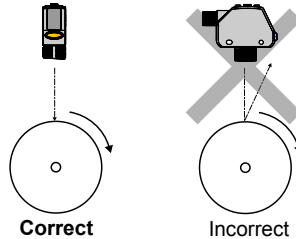

Figure 8. Orientation for a height difference

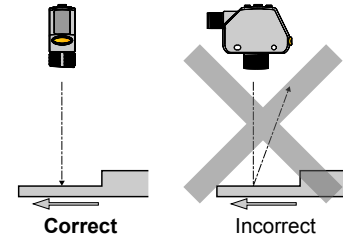

Figure 9. Orientation for a color or luster difference

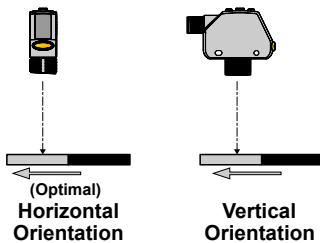
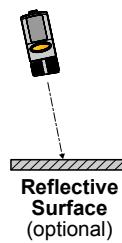

Figure 10. Orientation for highly reflective target <sup>¶</sup>



### Mount the Device

1. If a bracket is needed, mount the device onto the bracket.
2. Mount the device (or the device and the bracket) to the machine or equipment at the desired location. Do not tighten the mounting screws at this time.
3. Check the device alignment.
4. Tighten the mounting screws to secure the device (or the device and the bracket) in the aligned position.

<sup>¶</sup> Applying tilt to sensor may improve performance on reflective targets. The direction and magnitude of the tilt depends on the application, but a 15° tilt is often sufficient.

## Wiring Diagram—Threaded Barrel Models

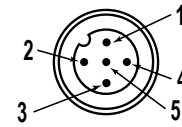
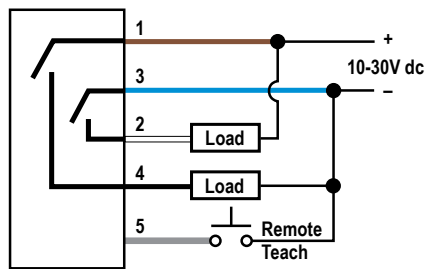

### Key

- 1 = Brown
- 2 = White
- 3 = Blue
- 4 = Black
- 5 = Gray



**Note:** Open lead wires must be connected to a terminal block.



**Note:** The input wire function is user-selectable; see the Instruction Manual for details. The default for the input wire function is off (disabled).

## Wiring Diagram—Flush Mount Models

### NPN Models

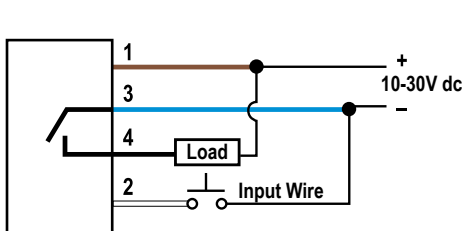

### PNP Models

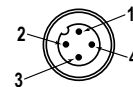
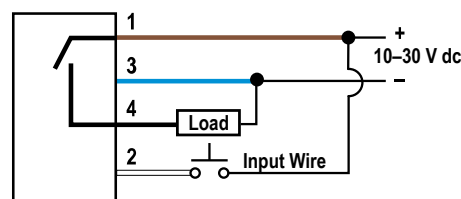

### Key

- 1 = Brown
- 2 = White
- 3 = Blue
- 4 = Black



**Note:** Open lead wires must be connected to a terminal block.



**Note:** The input wire function is user-selectable; see the Instruction Manual for details. The default for the input wire function is off (disabled).

## Cleaning and Maintenance

Clean the sensor when soiled and use with care.

Handle the sensor with care during installation and operation. Sensor windows soiled by fingerprints, dust, water, oil, etc. may create stray light that may degrade the peak performance of the sensor. Blow the window clear using filtered, compressed air, then clean as necessary using only water and a lint-free cloth.

## Sensor Programming

Program the sensor using the buttons on the sensor or the remote input (limited programming options).

In addition to programming the sensor, use the remote input to disable the buttons for security, preventing unauthorized or accidental programming changes. See the Instruction Manual, p/n 181483 for more information.

## Setup Mode

Access Setup mode and the sensor menu from Run mode by pressing and holding **MODE** for longer than 2 seconds. Use **+** and **-** to navigate through the menu. Press **SELECT** to select a menu option and access the submenus. Use **+** and **-** to navigate through the submenus. Press **SELECT** to select a submenu option and return to the top menu, or press and hold **SELECT** for longer than 2 seconds to select a submenu option and return immediately to Run mode.

To exit Setup mode and return to Run mode, navigate to **End** and press **SELECT**.

Figure 11. Sensor Menu Map—Channel 1

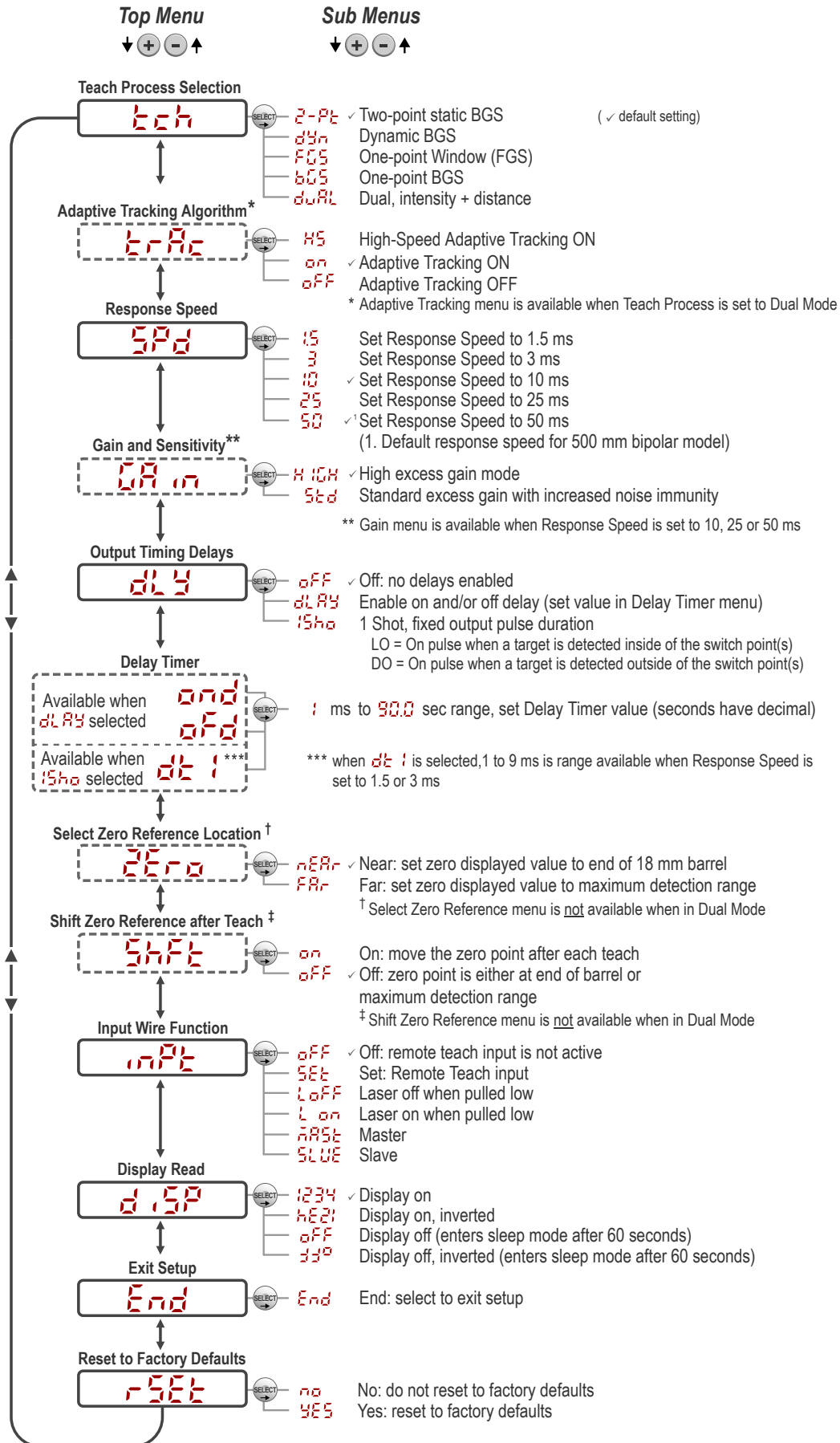

## Basic TEACH Instructions



Use the following instructions to teach the Q4X sensor. The instructions provided on the sensor display vary depending on the type of TEACH mode selected. Two-point TEACH is the default TEACH mode.





1. Press and hold **TEACH** for longer than 2 seconds to start the selected TEACH mode.
2. Present the target.
3. Press **TEACH** to teach the target. The target is taught and the sensor waits for the second target, if required by the selected TEACH mode, or returns to Run mode.  
Complete steps 4 and 5 only if required for the selected TEACH mode:
4. Present the second target.
5. Press **TEACH** to teach the target. The target is taught and the sensor returns to Run mode.

See the Instruction Manual for detailed instructions and other available TEACH modes. The TEACH modes include:

- Two-point static background suppression **2-PT** —Two-point TEACH sets a single switch point. The sensor sets the switch point between two taught target distances, relative to the shifted origin location.
- Dynamic background suppression **dYN** —Dynamic TEACH sets a single switch point during machine run conditions. The sensor takes multiple samples and the switch point is set between the minimum and the maximum sampled distances.
- One-point window (foreground suppression) **FGS** —One-point window sets a window (two switch points) centered around the taught target distance.
- One-point background suppression **BGS** —One-point background suppression sets a single switch point in front of the taught target distance. Objects beyond the taught switch point are ignored.
- Dual intensity + distance **dUAL** —Dual mode records the distance and amount of light received from the reference surface. See for more information about selecting a reference surface. The output switches when an object passing between the sensor and the reference surface changes the perceived distance or amount of returned light.

## Manual Adjustments



Manually adjust the sensor switch point using the  and  buttons.

1. From Run mode, press either  or  one time. The current switch point value flashes slowly.
2. Press  to move the switch point up or  to move the switch point down. After 1 second of inactivity, the new switch point value flashes rapidly, the new setting is accepted, and the sensor returns to Run mode.



**Note:** When FGS mode is selected (FGS indicator is on), manual adjustment moves both sides of the symmetrical threshold window simultaneously, expanding and collapsing the window size. Manual adjustment does not move the center point of the window.



**Note:** When dual mode is selected (DYN, FGS, and BGS indicators are on), after the TEACH process is completed, use the manual adjustment to adjust the sensitivity of the thresholds around the taught reference point. The taught reference point is a combination of the measured distance and returned signal intensity from the reference target. Manual adjustment does not move the taught reference point, but pressing  increases the sensitivity, and pressing  decreases the sensitivity. When re-positioning the sensor or changing the reference target, re-teach the sensor.

## Light Operate/Dark Operate

The default output configuration is light operate. To switch between light operate and dark operate, use the following instructions:

1. Press and hold **LO/DO** for longer than 2 seconds. The current selection displays.
2. Press **LO/DO** again. The new selection flashes slowly.
3. Press **SELECT** to change the output configuration and return to Run mode.



**Note:** If neither **SELECT** nor **LO/DO** are pressed after step 2, the new selection flashes slowly for a few seconds, then flashes quickly and the sensor automatically changes the output configuration and returns to Run mode.

## Locking and Unlocking the Sensor Buttons

Use the lock and unlock feature to prevent unauthorized or accidental programming changes.

Three settings are available:

- **uLoc** —The sensor is unlocked and all settings can be modified (default).
- **Loc** — The sensor is locked and no changes can be made.

- **Loc** —The switch point value can be changed by teaching or manual adjustment, but no sensor settings can be changed through the menu.

When in **Loc** mode, **Loc** displays when the **(SELECT)(TEACH)** button is pressed. The switch point displays when **(+)(DISP)** or **(-)(MODE)** are pressed, but **Loc** displays if the buttons are pressed and held.

When in **OLoc** mode, **Loc** displays when **(+)(DISP)** or **(-)(MODE)** are pressed and held. To access the manual adjust options, briefly press and release **(+)(DISP)** or **(-)(MODE)**. To enter TEACH mode, press the **(SELECT)(TEACH)** button and hold for longer than 2 seconds.

To enter **Loc** mode, hold **+** and press **-** four times. To enter **OLoc** mode, hold **+** and press **-** seven times. Holding **+** and pressing **-** four times unlocks the sensor from either lock mode and the sensor displays **wLoc**.

## Specifications

### Sensing Beam

Visible red Class 1 laser, 655 nm

### Supply Voltage (Vcc)

10 V DC to 30 V DC

### Power and Current Consumption, exclusive of load

< 675 mW

### Sensing Range—Threaded Barrel Models

**500 mm models:** 25 mm to 500 mm (0.98 in to 19.69 in)

**300 mm models:** 25 mm to 300 mm (0.98 in to 11.81 in)

**100 mm models:** 25 mm to 100 mm (0.98 in to 3.94 in)

### Sensing Range—Flush Mount Models

**310 mm models:** 35 mm to 310 mm (1.38 in to 12.20 in)

**110 mm models:** 35 mm to 110 mm (1.38 in to 4.33 in)

### Output Configuration

**Threaded Barrel Models:** Bipolar (1 PNP and 1 NPN) output

**Flush Mount Models:** PNP or NPN output, depending on model

### Output Rating

100 mA total maximum (protected against continuous overload and short circuit)

**Off-state leakage current:** < 5 µA at 30 V DC

**PNP On-state saturation voltage:** < 1.5 V DC at 100 mA load

**NPN On-state saturation voltage:** < 1.0 V DC at 100 mA load

### Discrete Output Distance Repeatability

Table 1: Discrete Output Repeatability—300/310 mm and 500 mm Models

Distance (mm)		Repeatability
Threaded Barrel Models	Flush Mount Models	
25 to 50 mm	35 to 60 mm	± 0.5 mm
50 to 300 mm	60 to 310 mm	± 1% of range
50 to 500 mm	60 to 510 mm	± 1.2% of range

Table 2: Discrete Output Repeatability—100/110 mm Models

Distance (mm)		Repeatability
Threaded Barrel Models	Flush Mount Models	
25 to 100 mm	35 to 110 mm	+/-0.2 mm

### Remote Input

**Allowable Input Voltage Range:** 0 to Vcc

**Active Low (internal weak pullup—sinking current):** Low State < 2.0 V at 1 mA max.

### Supply Protection Circuitry

Protected against reverse polarity and transient overvoltages

### Response Speed

User selectable:

- **15** —1.5 milliseconds
- **3** —3 milliseconds
- **10** —10 milliseconds
- **25** —25 milliseconds
- **50** —50 milliseconds

### Excess Gain—Threaded Barrel Models

Table 3: **HIGH** Excess Gain ( **Std** Excess Gain<sup>2)</sup>

Response Speed (ms)	Excess Gain—90% White Card			
	at 25 mm	at 100 mm	at 300 mm	at 500 mm
1.5	200	100	20	7
3	200	100	20	7
10	1000 (500)	500 (250)	100 (50)	36 (18)
25	2500 (1000)	1250 (500)	250 (100)	90 (36)
50	5000 (2500)	2500 (1250)	500 (250)	180 (90)

### Excess Gain—Flush Mount Models

Table 4: **HIGH** Excess Gain ( **Std** Excess Gain<sup>3)</sup>

Response Speed (ms)	Excess Gain—90% White Card		
	at 35 mm	at 110 mm	at 310 mm
1.5	200	100	20
3	200	100	20
10	1000 (500)	500 (250)	100 (50)
25	2500 (1000)	1250 (500)	250 (100)
50	5000 (2500)	2500 (1250)	500 (250)

<sup>2</sup>

- **Std** excess gain available in 10 ms, 25 ms, and 50 ms response speeds only
- **Std** excess gain provides increased noise immunity

<sup>3</sup>

- **Std** excess gain available in 10 ms, 25 ms, and 50 ms response speeds only
- **Std** excess gain provides increased noise immunity

**Beam Spot Size—300/310 mm and 500 mm Models**

Table 5: Beam Spot Size—300/310 mm and 500 mm Models

Distance (mm)		Size (Horizontal × Vertical)
Threaded Barrel Models	Flush Mount Models	
25	35	2.6 mm × 1.0 mm
150	160	2.3 mm × 0.9 mm
300	310	2.0 mm × 0.8 mm
500	-	1.9 mm × 1.0 mm

**Beam Spot Size—100/110 mm Models**

Table 6: Beam Spot Size—100/110 mm Models

Distance (mm)		Size (Horizontal × Vertical)
Threaded Barrel Models	Flush Mount Models	
25	35	2.4 mm × 1.0 mm
50	60	2.2 mm × 0.9 mm
100	110	1.8 mm × 0.7 mm

**Delay at Power Up**

< 750 ms

**Maximum Torque**

**Side mounting:** 1 N·m (9 in·lbs)  
**Nose mounting:** 20 N·m (177 in·lbs)

**Ambient Light Immunity**

> 5,000 lux at 300 mm  
 > 2,000 lux at 500 mm

**Connector**

**Threaded Barrel Models:** Integral 5-pin M12 male quick-disconnect connector  
**Flush Mount Models:** Integral 4-pin M12 male quick-disconnect connector

**Construction**

**Housing:** 316 L stainless steel  
**Lens cover:** PMMA acrylic  
**Lightpipe and display window:** polysulfone

**Environmental Rating**

IP67 per IEC60529  
 IP68 per IEC60529  
 IP69K per DIN 40050-9 per DIN40050-9

**Vibration**

MIL-STD-202G, Method 201A (Vibration: 10 Hz to 60 Hz, 0.06 inch (1.52 mm) double amplitude, 2 hours each along X, Y and Z axes), with device operating

**Shock**

MIL-STD-202G, Method 213B, Condition I (100G 6x along X, Y, and Z axes, 18 shocks), with device operating

**Required Overcurrent Protection**



**WARNING:** Electrical connections must be made by qualified personnel in accordance with local and national electrical codes and regulations.

Overcurrent protection is required to be provided by end product application per the supplied table.  
 Overcurrent protection may be provided with external fusing or via Current Limiting, Class 2 Power Supply.  
 Supply wiring leads < 24 AWG shall not be spliced.  
 For additional product support, go to [www.bannerengineering.com](http://www.bannerengineering.com).

Supply Wiring (AWG)	Required Overcurrent Protection (Amps)
20	5.0
22	3.0
24	2.0
26	1.0
28	0.8
30	0.5

**Typical Temperature Effect<sup>‡</sup>**

0.05 mm/°C at <125 mm (threaded barrel models)/< 135 mm (flush mount models)  
 0.35 mm/°C at 300 mm (threaded barrel models)/< 310 mm (flush mount models)  
 1 mm/°C at 500 mm (threaded barrel models)

**Chemical Compatibility**

Compatible with commonly used acidic or caustic cleaning and disinfecting chemicals used in equipment cleaning and sanitation. ECOLAB® certified. Compatible with typical cutting fluids and lubricating fluids used in machining centers

**Application Note**

For optimum performance, allow 10 minutes for the sensor to warm up

**Operating Conditions**

-10 °C to +50 °C (+14 °F to +122 °F)  
 35% to 95% relative humidity

**Storage Temperature**

-25 °C to +75 °C (-13 °F to +167 °F)

**Certifications**



**Banner Engineering Europe** Park Lane, Culliganlaan 2F bus 3, 1831 Diegem, BELGIUM

**Turck Banner LTD** Blenheim House, Blenheim Court, Wickford, Essex SS11 8YT, Great Britain



Class 2 power  
 UL Environmental Rating: Type 1



chemical compatibility certified

ECOLAB is a registered trademark of Ecolab USA Inc. All rights reserved.

**FCC Part 15**

This device complies with Part 15 of the FCC Rules. This equipment generates, uses, and can radiate radio frequency energy and, if not installed and used in accordance with the instruction manual, may cause harmful interference to radio communications. Operation is subject to the following two conditions: 1) This device may not cause harmful interference; and 2) This device must accept any interference received, including interference that may cause undesired operation.

**Industry Canada**

This device complies with CAN ICES-3 (A)/NMB-3(A). Operation is subject to the following two conditions: 1) This device may not cause harmful interference; and 2) This device must accept any interference received, including interference that may cause undesired operation.

<sup>‡</sup> Calculated as an average temperature effect across the sensor's full operating temperature.



Cet appareil est conforme à la norme NMB-3(A). Le fonctionnement est soumis aux deux conditions suivantes : (1) ce dispositif ne peut pas occasionner d'interférences, et (2) il doit tolérer toute interférence, y compris celles susceptibles de provoquer un fonctionnement non souhaité du dispositif.

### Performance Curves—Threaded Barrel Models

Figure 12. Minimum Object Separation Distance (90% to 6% reflectance)

#### Minimum Separation Distance Between Target and Background for: Uniform and Non-Uniform Targets

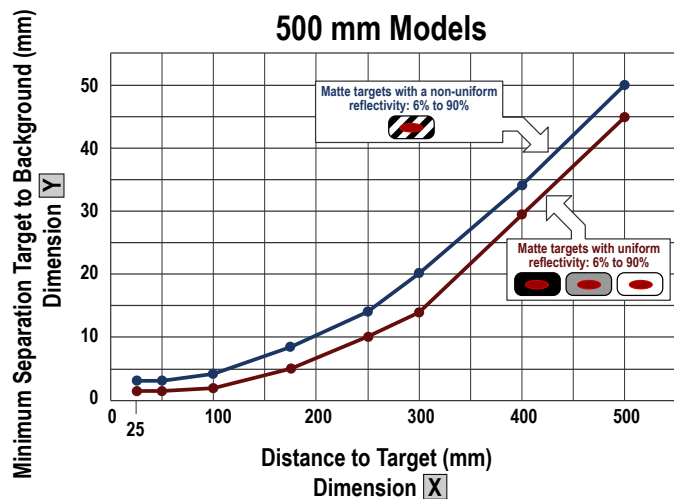
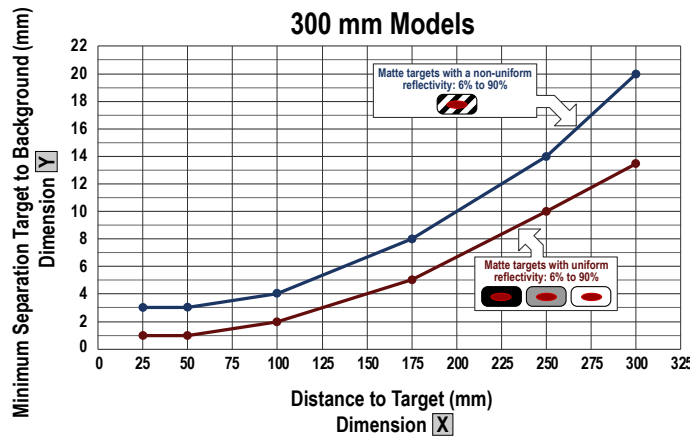
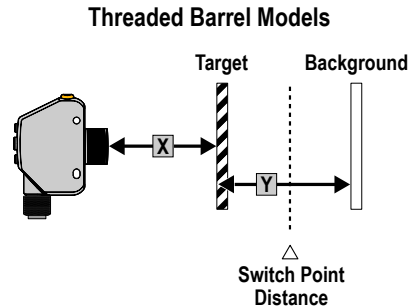
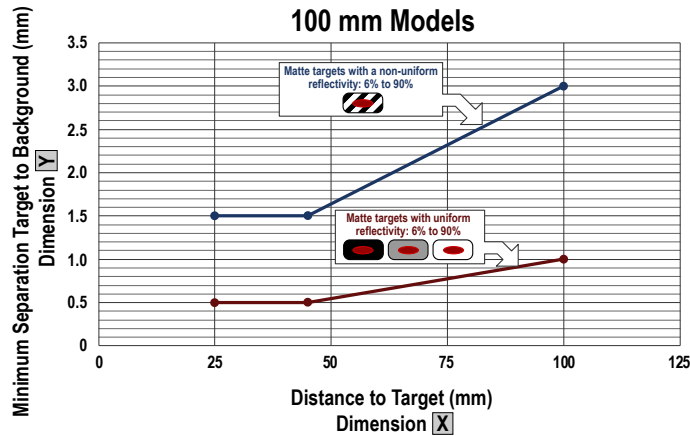

## Performance Curves—Flush Mount Models

Figure 13. Minimum Object Separation Distance (90% to 6% reflectance)

## Minimum Separation Distance Between Target and Background for: Uniform and Non-Uniform Targets

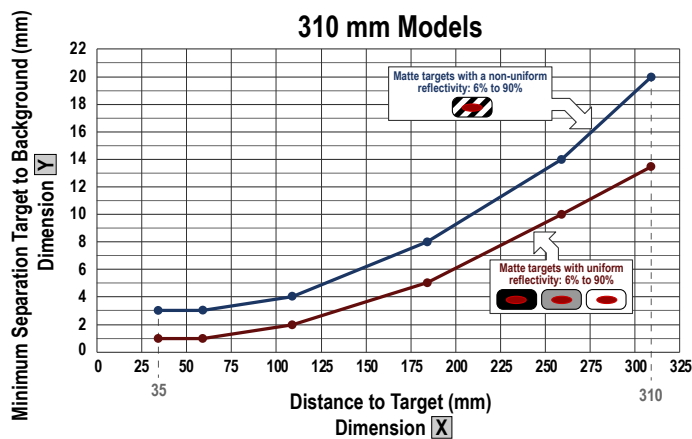
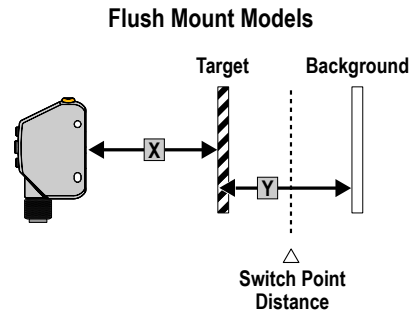
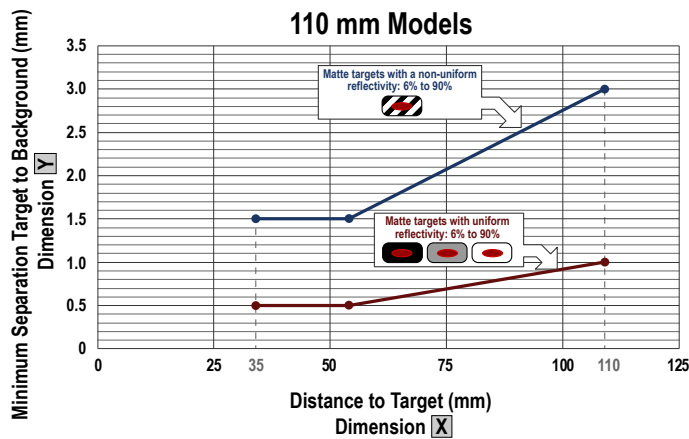

## Dual Mode Reference Surface Considerations

Optimize reliable detection by applying these principals when selecting your reference surface, positioning your sensor relative to the reference surface, and presenting your target. The robust detection capabilities of the Q4X allows successful detection even under non-ideal conditions in many cases. Typical reference surfaces are metal machine frames, conveyor side rails, or mounted plastic targets. Contact Banner Engineering if you require assistance setting up a stable reference surface in your application. For detailed instructions for detecting clear or transparent objects, refer to the Instruction Manual, p/n 181483.

- Select a reference surface with these characteristics where possible:
  - Matte or diffuse surface finish
  - Fixed surface with no vibration
  - Dry surface with no build-up of oil, water, or dust
- Position the reference surface between 50 mm and the maximum sensing range for threaded barrel models or between 60 mm and the maximum sensing range for flush mount models.
- Position the target to be detected as close to the sensor as possible, and as far away from the reference surface as possible.
- Angle the sensing beam relative to the target and relative to the reference surface 10 degrees or more.