

ZUD-CD-08-0190-1 (1/55)

October 30, 2008

Yoshinari Ando, Team Manager
Development Tool Solution Group
Multipurpose Microcomputer Systems Division
Microcomputer Operations Unit
NEC Electronics Corporation

User's Manual (Preliminary)

QB-V850ESX3H

In-Circuit Emulator

Target Devices

V850E/SJ3-H

V850E/SK3-H

Contents

INTRODUCTION	7
CHAPTER 1 GENERAL	9
1.1 Hardware Specifications	10
1.2 System Specifications.....	11
1.3 Functional Overview	12
1.3.1 Program execution function (real-time execution function).....	12
1.3.2 Step execution function (non-real-time execution function).....	12
1.3.3 Break functions (program execution stop).....	12
1.3.4 Trace function (program execution history)	14
1.3.5 Real-time RAM monitoring function (checking RAM values during program execution).....	16
1.3.6 Time measurement function	16
1.3.7 Event function (specific CPU operation detection).....	17
1.3.8 Event link function (event combinations).....	17
1.3.9 Peripheral break function.....	17
1.3.10 Mask function	18
1.3.11 Optional functions.....	18
1.3.12 Function to control reset when power of target system is turned off.....	18
1.4 System Configuration	19
1.5 Package Contents	22
1.6 AC Adapter for IECUBE.....	23
CHAPTER 2 SETUP PROCEDURE	24
2.1 Names and Functions of Hardware	25
2.2 Removal of Acrylic Board	26
2.3 Clock Settings	27
2.4 Software Settings.....	27
2.4.1 When using ID850QB as debugger	27
2.4.2 When using other than ID850QB (MULTI™, etc.) as debugger.....	27
2.5 Mounting and Connecting Connectors (When Using S Type)	28
2.5.1 Mounting TC to target system	28
2.5.2 Inserting EA into TC	28
2.5.3 Precautions for handling TC, EA, MA, CA, and SA	29
2.5.4 Precautions for mounting IC using MA	30
2.6 Mounting and Connecting Connectors (When Using T Type).....	31
2.6.1 Mounting TC in target system.....	31
2.6.2 Connecting YQ on TC	31
2.6.3 Inserting EA into YQ.....	32
2.6.4 Precautions for handling TC, YQ, and SA	32
2.6.5 Precautions for mounting IC using TC and MA	33
2.7 Connecting QB-V850ESX3H to Target System	34
2.7.1 When not using extension probe (QB-xxx-EP-0xS).....	34
2.7.2 When using extension probe (QB-xxx-EP-0xS).....	35

2.8	Connecting USB Interface Cable and AC Adapter	39
2.9	Switching Power On and Off.....	39
CHAPTER 3	SETTINGS AT PRODUCT SHIPMENT.....	40
CHAPTER 4	NOTES	41
4.1	Cautions Regarding Differences Between Actual Device And Emulator	41
4.1.1	Real time operation in 1MB or upper internal ROM area.....	41
4.1.2	Operation after power application to target system	41
4.1.3	Oscillator	41
4.1.4	Pin characteristics	41
4.1.5	Notes on ROM correction function.....	41
4.1.6	Notes on flash self programming function	42
4.1.7	Notes on DBTRAP instruction	42
4.1.8	On-chip debug function	42
4.1.9	Current consumption	42
4.1.10	Cautions when using extension probe.....	42
4.1.11	RAM retention flag.....	42
4.2	Notes On Debugging	43
4.2.1	Notes on Non-map Break	43
4.2.2	PSC Register Access	43
4.2.3	Notes on DBPC, DBPSW, and ECR Registers	43
4.2.4	Notes on Trace Display Sequence	43
4.2.5	Notes on Starting Debugger	43
4.2.6	Simultaneously Executing Two Instructions When Hardware Break Is Set	44
4.2.7	Operation during Break	45
4.2.8	When an Illegal Break Occurs during Program Execution in Internal RAM	45
4.2.9	Conflict between program execution for internal RAM and DMA transfer.....	45
4.2.10	Watchdog timer during break	46
4.2.11	16-bit timer M during break	46
4.2.12	Accessing UAnRX register during break	46
4.2.13	Accessing DR register during break	47
4.2.14	Accessing CnRX register during break	47
4.2.15	Accessing CnRGPT register during break.....	47
4.2.16	Accessing C0TGPT register during break	48
4.2.17	Accessing CnGNCTRL register during break.....	48
4.2.18	Entering and releasing STOP mode when RESET pin is masked.....	49
4.2.19	A/D conversion function during a break.....	49
4.2.20	Cautions fail safe break.....	51
CHAPTER 5	OPTIONAL FUNCTIONS.....	52
5.1	Coverage Measurement Function	52
5.1.1	Functional outline	52
5.2.2	Differences from hardware specifications	53
5.3	TimeMachine Function	53

5.4 Changes to Top Side of Product Consequent to Addition of Optional Functions 53

5.5 How to Add Optional Functions 54

IECUBE is a registered trademark of NEC Electronics Corporation in Japan and Germany.

MULTI, Green Hills Software, TimeMachine, and SuperTrace are trademarks of Green Hills Software, Inc.

- **The information in this document is current as of October 2008. The information is subject to change without notice. For actual design-in, refer to the latest publications of NEC Electronics data sheets or data books, etc., for the most up-to-date specifications of NEC Electronics products. Not all products and/or types are available in every country. Please check with an NEC Electronics sales representative for availability and additional information.**
- No part of this document may be copied or reproduced in any form or by any means without the prior written consent of NEC Electronics. NEC Electronics assumes no responsibility for any errors that may appear in this document.
- NEC Electronics does not assume any liability for infringement of patents, copyrights or other intellectual property rights of third parties by or arising from the use of NEC Electronics products listed in this document or any other liability arising from the use of such products. No license, express, implied or otherwise, is granted under any patents, copyrights or other intellectual property rights of NEC Electronics or others.
- Descriptions of circuits, software and other related information in this document are provided for illustrative purposes in semiconductor product operation and application examples. The incorporation of these circuits, software and information in the design of a customer's equipment shall be done under the full responsibility of the customer. NEC Electronics assumes no responsibility for any losses incurred by customers or third parties arising from the use of these circuits, software and information.
- While NEC Electronics endeavors to enhance the quality, reliability and safety of NEC Electronics products, customers agree and acknowledge that the possibility of defects thereof cannot be eliminated entirely. To minimize risks of damage to property or injury (including death) to persons arising from defects in NEC Electronics products, customers must incorporate sufficient safety measures in their design, such as redundancy, fire-containment and anti-failure features.
- NEC Electronics products are classified into the following three quality grades: "Standard", "Special" and "Specific".
 - The "Specific" quality grade applies only to NEC Electronics products developed based on a customer-designated "quality assurance program" for a specific application. The recommended applications of an NEC Electronics product depend on its quality grade, as indicated below. Customers must check the quality grade of each NEC Electronics product before using it in a particular application.
 - "Standard": Computers, office equipment, communications equipment, test and measurement equipment, audio and visual equipment, home electronic appliances, machine tools, personal electronic equipment and industrial robots.
 - "Special": Transportation equipment (automobiles, trains, ships, etc.), traffic control systems, anti-disaster systems, anti-crime systems, safety equipment and medical equipment (not specifically designed for life support).
 - "Specific": Aircraft, aerospace equipment, submersible repeaters, nuclear reactor control systems, life support systems and medical equipment for life support, etc.

The quality grade of NEC Electronics products is "Standard" unless otherwise expressly specified in NEC Electronics data sheets or data books, etc. If customers wish to use NEC Electronics products in applications not intended by NEC Electronics, they must contact an NEC Electronics sales representative in advance to determine NEC Electronics' willingness to support a given application.

(Note)

- (1) "NEC Electronics" as used in this statement means NEC Electronics Corporation and also includes its majority-owned subsidiaries.
- (2) "NEC Electronics products" means any product developed or manufactured by or for NEC Electronics (as defined above).

1. Circumstances not covered by product guarantee

- If the product was disassembled, altered, or repaired by the customer
- If it was dropped, broken, or given another strong shock
- Use at overvoltage, use outside guaranteed temperature range, storing outside guaranteed temperature range
- If power was turned on while the AC adapter, USB interface cable, or connection to the target system was in an unsatisfactory state
- If the cable of the AC adapter, the USB interface cable, the extension probe, or the like was bent or pulled excessively
- When using an AC adapter (QB-COMMON-PW-xx) not supported in the region of use
- If the product got wet
- If this product is connected to the target system when there is a potential difference between the GND of this product and GND of the target system.
- If the connectors or cables are plugged/unplugged while this product is in the power-on state.
- If excessive load is applied to the connectors or sockets. ^{Note}
- If a metal part of the power switch, cooling fan, or another such part comes in contact with an electrostatic charge
- If the product is used or stored in an environment where it may likely be exposed to electrostatic discharge or electrical noise

Note For handling, see **2.6 Mounting and Connecting Connectors (When Using S Type)**, **2.7 Mounting and Connecting Connectors (When Using T Type)** .

2. Safety precautions

- If used for a long time, the product may become hot (50°C to 60°C). Be careful of low temperature burns and other dangers due to the product becoming hot.
- Be careful of electrical shock. There is a danger of electrical shock if the product is used as described above in **1 Circumstances not covered by product guarantee**.

INTRODUCTION

Readers	This manual is intended for users who wish to perform debugging using the QB-V850ESX3H. The readers of this manual are assumed to be familiar with the device functions and usage, and to have knowledge of debuggers.	
Purpose	This manual is intended to give users an understanding of the basic specifications and correct usage of the QB-V850ESX3H.	
Organization	<p>This manual is divided into the following sections.</p> <ul style="list-style-type: none"> • General • Setup procedure • Settings at product shipment • Notes • Optional functions 	
How to Read This Manual	<p>It is assumed that the readers of this manual have general knowledge in the fields of electrical engineering, logic circuits, and microcontrollers.</p> <p>This manual describes the basic setup procedures and how to set switches.</p> <p>To understand the overall functions and usages of the QB-V850ESX3H → Read this manual in the order of the CONTENTS.</p> <p>To know the manipulations, command functions, and other software-related settings of the QB-V850ESX3H → See the user's manual of the debugger (supplied with the QB-V850ESX3H) to be used.</p>	
Conventions	<p>Note:</p> <p>Caution:</p> <p>Remark:</p> <p>Numeric representation:</p> <p>Prefix indicating power of 2 (address space, memory capacity):</p>	<p>Footnote for item marked with Note in the text</p> <p>Information requiring particular attention</p> <p>Supplementary information</p> <p>Binary ... xxxx or xxxxB</p> <p>Decimal ... xxxx</p> <p>Hexadecimal ... xxxxH</p> <p>K (kilo): $2^{10} = 1,024$</p> <p>M (mega): $2^{20} = 1,024^2$</p>

Terminology

The meanings of the terms used in this manual are described in the table below.

Term	Meaning
Target device	This is the device to be emulated.
Target system	This is the system to be debugged (system provided by the user). This includes the target program and the hardware provided by the user.
IECUBE [®]	Generic name for NEC Electronics' high-performance, compact in-circuit emulator.

Related Documents

Please use the following documents in combination with this manual.

The related documents listed below may include preliminary versions. However, preliminary versions are not marked as such.

Documents Related to Development Tools (User's Manuals)

Document Name		Document Number
CA850 Ver. 3.00 C Compiler Package	Operation	U17293E
	C Language	U17291E
	Assembly Language	U17292E
	Link Directives	U17294E
ID850QB Ver. 3.40 Integrated Debugger	Operation	U18604E
SM+ System Simulator	Operation	U18010E
	User Open Interface	U17663E
RX850 Ver. 3.20 Real-Time OS	Basics	U13430E
	Installation	U17419E
	Technical	U13431E
	Task Debugger	U17420E
RX850 Pro Ver. 3.20 Real-Time OS	Basics	U13773E
	Installation	U17421E
	Technical	U13772E
	Task Debugger	U17422E
RX850V4 Ver. 4.22 Real-Time OS	Functionalities	U16643E
	Task Debugger	U16811E
AZ850 Ver. 3.30 System Performance Analyzer		U17423E
AZ850V4 Ver. 4.10 System Performance Analyzer		U17093E
PM+ Ver. 6.00 Project Manager		U17178E

Caution The related documents listed above are subject to change without notice. Be sure to use the latest version of each document for designing, etc.

CHAPTER 1 GENERAL

The QB-V850ESX3H is an in-circuit emulator for emulating the target device shown below.

Hardware and software can be debugged efficiently in the development of systems in which the target device is used. This manual describes basic setup procedures, hardware specifications, system specifications, and how to set switches.

Target device : V850E/SJ3-H , V850E/SK3-H

1.1 Hardware Specifications

Table 1-1. QB-V850ESX3H Hardware Specifications

Parameter		Specification			
Target system interface voltage		$BV_{DD} \leq V_{DD} = EV_{DD} = AV_{REF0} = AV_{REF1}$ $V_{SS} = EV_{SS} = BV_{SS} = AV_{SS} = 0\text{ V}$			
		V_{DD}	EV_{DD}	BV_{DD}	AV_{REF0}, AV_{REF1}
When A/D converter or D/A converter is used		3.0 to 3.6 V	3.0 to 3.6 V	2.7 to 3.6 V	3.0 to 3.6 V
When both A/D converter and D/A converter are not used		2.85 to 3.6 V	2.85 to 3.6 V	2.7 to 3.6 V	2.85 to 3.6 V
Maximum operating frequency		48 MHz			
Operating temperature range		0 to 40°C (No condensation)			
Storage temperature range		-15 to 60°C (No condensation)			
External dimensions		See Figure 1-1			
Power consumption	AC adapter	15 V, 1 A			
	Target system power supply	Same level or lower than target device (Except for standby mode)			
Weight		Approx. 500 g			
Host interface		USB interface (1.1, 2.0)			

Figure 1-1. External Dimensions

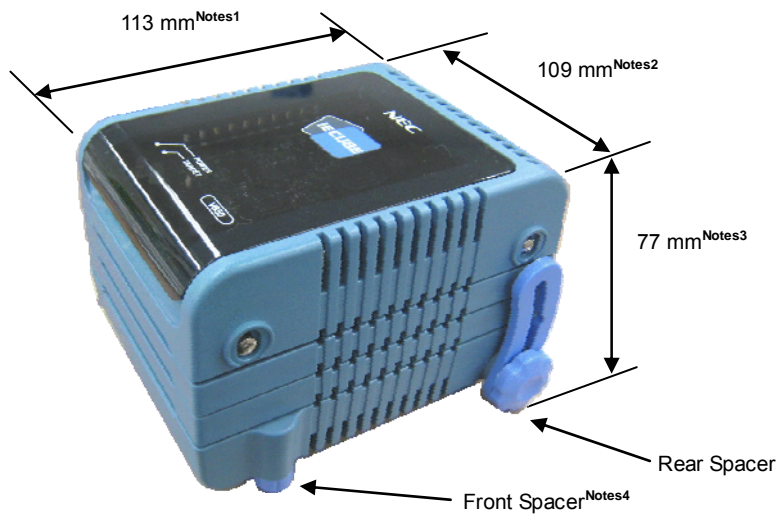

- Notes 1** Does not include projection of power switch
- 2** Includes projection of screw that fixes rear spacer
- 3** Dimension when rear spacer is made shortest (107 mm when longest)
- 4** Front spacer can vary from 20 mm (longest) to 5 mm (shortest)

1.2 System Specifications

This section shows the QB-V850ESX3H system specifications. For the usage of the debugging function, refer to **ID850QB Ver. 3.40 Operation User's Manual (U18604E)**.

Table 1-2. QB-V850ESX3H System Specifications

	Parameter	Specification
Emulation memory capacity	Internal ROM	1.5 MB max.
	Internal RAM	92 KB max.
	External memory	None
Program execution functions	Real-time execution function	Go, Start from Here, Go & Go, Come Here, Restart, Return Out
	Non-real-time execution function	Step In, Next Over, Slowmotion
Break functions	Hardware break	Execution: 10 points Access: 6 points
	Software break	2000 points
	Fail-safe break	Non-map, I/O illegal, write protect
	Other	Trace full break, forced break, timer overflow break
Trace functions	Trace data types	Branch-source PC, branch-destination PC, all PCs, all execution data, access data, access address, R/W status, time stamp, DMA point (start/end)
	Trace modes	Real-time trace, Complete trace
	Trace events	Delay trigger, section, qualify
	Memory capacity	256K frames
Real-time RAM monitoring function		256 bytes × 8 points
Time measurement functions	Measurement clock	50 MHz
	Measurement objects	Beginning through end of program execution Start event through end event (7 sections)
	Maximum measurement time	Approximately 195 hours (When using measurement-dedicated clock divided by 32)
	Minimum resolution	20 ns
	Number of timers for measurement	8
	Measurement results	Execution time (Start through end of execution) Maximum, minimum, average, pass count (between events)
	Other	Timer overflow break function (1 point)
Time Machine function (optional ^{Note})		Contact a GHS tool dealer.
Coverage function (optional ^{Note})		Detection of execution or pass (optional)
	Measured range	Internal ROM space + arbitrary 1 MB space
Other functions		Mapping function, event function, register manipulation function, memory manipulation function

Note Refer to **CHAPTER 5 OPTIONAL FUNCTIONS**.

Caution Depending on the debugger, some functions are not supported.

1.3 Functional Overview

IECUBE is provided with a wealth of debug functions to enable efficient program debugging, in addition to being used to emulate the operation of a target device. An overview of the functions is provided in this section.

Some functions are not supported, depending on the debugger to be used. See also the manual of the debugger to be used to confirm.

1.3.1 Program execution function (real-time execution function)

The program execution function enables program execution equivalent to that of the target device. The executed program can be stopped under various conditions by using the break functions (1.3.3 Break functions (program execution stop)). The operation of only a function can be checked by executing a program, because a program can be executed from any address.

1.3.2 Step execution function (non-real-time execution function)

The step execution function can be used to execute instructions one by one, in assemble instruction units. Only instructions to be executed purely in steps can be executed, because interrupts are not acknowledged during step execution.

Caution Step execution to be performed at the C language level is performed by a debugger using the break function. In this case, interrupts are acknowledged in step execution. Consequently, if processing at the interrupt destination cannot be completed, step execution may not be completed. For handling such a case, see the manual of the debugger.

1.3.3 Break functions (program execution stop)

The break functions are used to stop program execution. With IECUBE, program execution can be stopped under the following various conditions. See (1) to (5) for an overview of each break function.

- An address has been executed → Hardware break function, software break function
- A variable has been accessed → Hardware break function
- An access-prohibited space has been accessed → Fail-safe break function
- A specific time has elapsed → Timer overflow break function

Figure 1-2. Image of Having Set Break Function by Using Debugger ID850QB

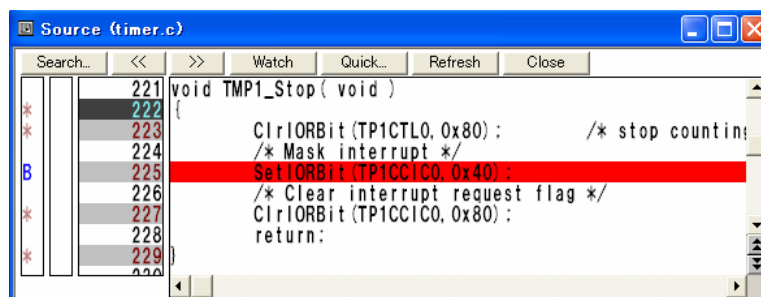

Variable values can be checked during a break and a program can be executed again by changing register values, because the CPU operates even during a break (while the program is stopped). Interrupts generated during the break are suspended, because basically peripheral functions also operate during the break. Use the peripheral break function (1.3.9 Peripheral break function) to stop peripheral functions during the break.

(1) Hardware break function

The hardware break function is used to observe the CPU bus cycles and set a break for a specific fetch or access operation. For example, a break can be set by detecting a state where an address has been executed or a variable has been accessed. For states that can be set, see **1.3.7 Event function (specific CPU operation detection)**.

Caution The address for which a break has been set is at a position ahead of the address where an actual access has occurred, because the break set for the access (write, read) is detected at an MEM stage or a WB stage on the CPU pipeline.

(2) Software break function

The software break function is used to set a break when a specific address has been executed (fetched). The feature of the software break function is the large number of break points that can be set, because the function is performed by replacing with a break instruction (DBTRAP instruction) the instruction of an address for which a break is to be set.

Caution When obtaining the checksum of a memory space, the actual theoretical value will be different from the result due to the replacement of the instruction. Furthermore, break points cannot be set for a ROM that has been connected to an external bus. Use the hardware break function to solve such problems.

(3) Fail-safe break function

This function is used to set a break when the CPU has performed an illegal operation. For example, a break is set when a peripheral I/O register, that has written to a ROM area and is to be accessed in 8-bit units, is accessed in 16-bit units. The following illegal operations can be detected by using the fail-safe break function.

- Accesses (fetching, reading, writing) to areas that are not mapped (prohibited areas)
- A write operation for the ROM area
- The following illegal operations for a peripheral I/O register
 - Accesses with different access bit widths
 - A write operation for a read-only register
 - A read operation for a write-only register

(4) Timer overflow break function

This function is used to set a break when a time set by using the time measurement function (**1.3.6 Time measurement function**) has elapsed. For example, if the execution time of a function must be 2 ms, a break can be set when at least 2 ms have elapsed between starting and ending the function. This function and the trace function (**1.3.4 Trace function (program execution history)**) can be used together to find the source that has taken time.

(5) Forcible break function

This function is used to forcibly stop a program when it is desired to be stopped.

1.3.4 Trace function (program execution history)

The trace function can be used to check the CPU execution history (trace). Items (1) to (9) can be recorded in the execution history.

Figure 1-3. Image of Execution History (Trace) with Debugger ID850QB

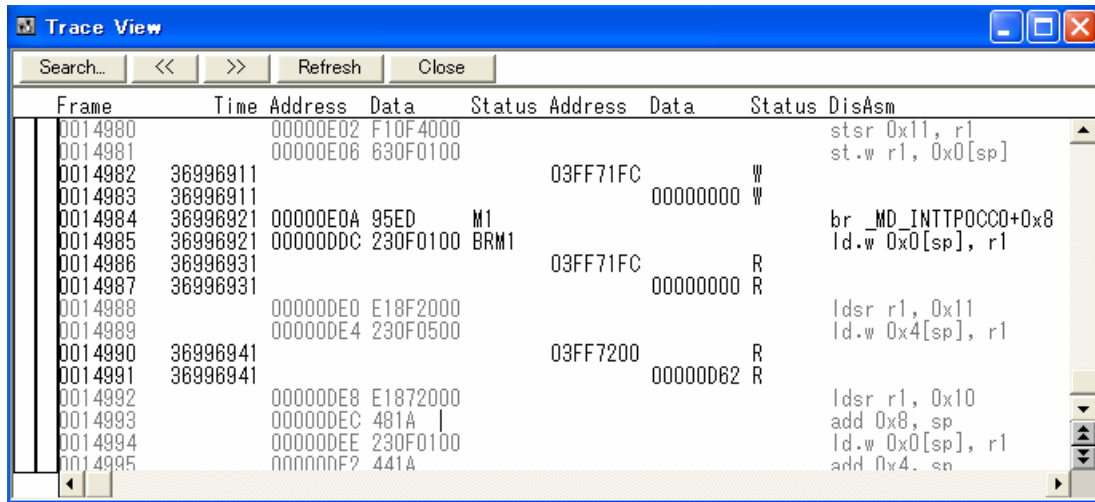

Frame	Time	Address	Data	Status	Address	Data	Status	DisAsm
0014980		00000E02	F10F4000					str 0x11, r1
0014981		00000E06	630F0100					st.w r1, 0x0[sp]
0014982	36996911				03FF71FC		W	
0014983	36996911					00000000	W	
0014984	36996921	00000E0A	95ED	M1				br _MD_INTTPOCCD+0x8
0014985	36996921	00000DDC	230F0100	BRM1				ld.w 0x0[sp], r1
0014986	36996931				03FF71FC		R	
0014987	36996931					00000000	R	
0014988		00000DE0	E18F2000					ldsr r1, 0x11
0014989		00000DE4	230F0500					ld.w 0x4[sp], r1
0014990	36996941				03FF7200		R	
0014991	36996941					00000062	R	
0014992		00000DE8	E1872000					ldsr r1, 0x10
0014993		00000DEC	481A					add 0x8, sp
0014994		00000DEE	230F0100					ld.w 0x0[sp], r1
0014995		00000DF2	441A					add 0x4, sp

(1) Program counter (PC) of branch source and branch destination

The PCs of a branch source and a branch destination can be recorded in the history.

Consequently, practically all executed programs can be checked, because programs executed between branch points also will be clarified. The amount of trace memory used can be saved and more history items can be traced by that amount, by recording only branch information. (The amount of traces that can be traced back depends on the number of branches.)

(2) All executed addresses

All executed address can be recorded in the history.

Normally, the programs that have been executed can be traced back if branch PC information described in (1) is available. This trace information is mainly used by the coverage function (5.2 Coverage Measurement Function).

(3) Access data/access address

Access addresses for memories and peripheral I/O registers, and access data can be recorded in the history. Read and write operations can also be recorded in the history.

Caution Accesses to CPU program registers (such as r1 and r2) and system registers (such as PSW and EIPC) cannot be recorded in the history. Furthermore, if an internal RAM is successively accessed for at least 32 times, some trace information may be omitted. (Whether trace information has been omitted can be checked in the debugger display.)

To prevent such omissions, IECUBE is provided with a mode (trace priority mode) in which the CPU execution cycle is stopped and the acquisition of traces is prioritized. Note that, when the trace priority mode is executed, however, operation may not be performed in real-time.

(4) Access program counter (PC)

PCs that have accessed memories and peripheral I/O registers can be recorded in the history.

(5) Time stamp

The time elapsed from the trace start point can be added to each trace information. The timer performance for time stamps is the same as that of the time measurement function (**1.3.6 Time measurement function**). For the timer performance, see the time measurement function column in **Table 1-2. QB-V850ESX3H System Specifications**.

Caution The addition of a time stamp is not suited for accurately measuring time in 1-instruction units, because only one time stamp is added to four pieces of trace information at most. If all execution addresses are left as trace information, only one time stamp is added to four instructions. The same applies when the timer resolution is slower than the CPU operation frequency. Use the time measurement function (**1.3.6 Time measurement function**) to accurately measure time.

(6) DMA start and end points (DMA points)

When the DMA function of the target microcontroller is being used, the DMA start and end points can be recorded in the history.

(7) History of specific sections (section trace)

Only specific sections can be recorded in the history by using the event function (**1.3.7 Event function (specific CPU operation detection)**) in combination. For example, the execution history of from the start to the end of a function can be recorded.

(8) History of specific phenomenon occurred (qualify trace)

Only the occurrence of specific phenomena can be recorded in the history by using the event function (**1.3.7 Event function (specific CPU operation detection)**) in combination. For example, a history of having accessed to only a variable can be recorded.

(9) Recording histories before and after specific phenomenon has occurred (delay trigger trace)

The history after a specific phenomenon has occurred can be recorded by using the event function (**1.3.7 Event function (specific CPU operation detection)**) in combination. This is similar to being able to observe a signal waveform by assuming an edge as a trigger, when using an oscilloscope to observe a signal.

For example, the program execution histories before and after a write access has been performed for a variable can be viewed.

1.3.5 Real-time RAM monitoring function (checking RAM values during program execution)

The real-time RAM monitoring function can be used to check RAM values during program execution. Real-time operation is guaranteed so that program execution is not affected when reading RAM values. Furthermore, whether the RAM has been read or written can be checked.

Figure 1-4. Image of Having Displayed Memory Space by Using Debugger ID850QB

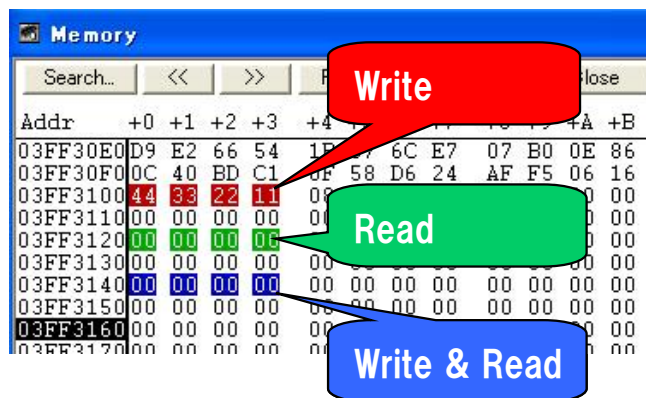

Caution When a RAM to be monitored has been changed during a break or changed by the DMA function of the target microcontroller, the changed values cannot be monitored. Only RAM values that have been changed by CPU accesses can be monitored during program execution.

1.3.6 Time measurement function

This function is used to measure the execution time of a specific section. The measurement start and end points can be set by using the event function (1.3.7 Event function (specific CPU operation detection)).

In addition, the maximum, minimum, and average execution time and the number by which the measurement section has been passed can be measured. For the performance of the time measurement function, see Table 1-2. QB-V850ESX3H System Specifications.

Figure 1-5. Image of Having Displayed Time Measurement Result by Using Debugger ID850QB

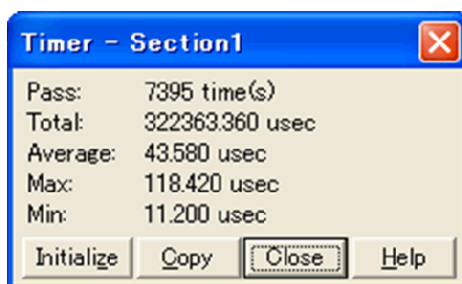

1.3.7 Event function (specific CPU operation detection)

The event function is used to detect specific fetch and access operations by observing the CPU bus cycle. CPU operations, such as of an address being executed and a variable being accessed can be detected. Such specific CPU operations are called events. Use the event function together with the following functions.

- Hardware break function
- Trace function
- Time measurement function

The events that can be registered by using the event function are as follows.

(1) Pre-execution event

A pre-execution event is detected when execution of an address is attempted. It can be used only with the hardware break function. Two pre-execution event points can be specified.

[Detection conditions that can be specified]

- Execution address

(2) Post-execution event

A post-execution event is detected when an address has been executed. The address of a post-execution event can be specified as a range. Up to eight post-execution event points can be specified, but if the execution address has been specified as a range, two points will be consumed. When the execution address has been specified as a range for all events, four event points can be specified.

[Detection conditions that can be specified]

- Execution address (can be specified as a range)

(3) Access event

An access event is detected when an address has been accessed (read or written). The following detection conditions can be specified for an access event.

Up to six access event points can be specified, but if the access address has been specified as a range, two points will be consumed. When the access address has been specified as a range for all events, three event points can be specified.

[Detection conditions that can be specified]

- Access address (can be specified as a range)
- Access data
- Access size
- Access status (read, write, both read and write)

1.3.8 Event link function (event combinations)

The event link function is used to combine into one event, events that have been registered by using the event function (1.3.7 Event function (specific CPU operation detection)). It is used to detect a specific sequence, such as when an address has been executed after a variable was accessed.

1.3.9 Peripheral break function

When the break function has been used to stop program execution, peripheral functions other than the watchdog timer continue to operate in general, but some peripheral functions can be stopped by using the peripheral break function. See 4.2.7 Operation during Break for details.

1.3.10 Mask function

The mask function can be used to mask the following sources.

- Reset (external reset, Internal reset)
- Non-maskable interrupt
- Bus hold request input (HLDRQ pin)
- External wait input (WAIT pin)

1.3.11 Optional functions

The following optional functions can be added to IECUBE. See **CHAPTER 5 OPTIONAL FUNCTIONS** for details.

- Coverage function
- TimeMachineTM function

1.3.12 Function to control reset when power of target system is turned off

When the power supply voltage of the target interface is decreased by 10% from the value stated in Table 1-1 when the target system is connected and a program is being executed, a state equivalent to a reset state of the target device is entered. When the power supply voltage of the target interface has been restored, the reset will be released and program execution will be started.

Consequently, the operation of the target system when its power is turned on can be pseudo-checked.

Caution The operation performed after a reset by this function will not be completely equivalent to an operation of the target device. Mount an actual device and perform final verification of the operation when starting the power supply.

1.4 System Configuration

There are two configuration types: S Type and T Type.

This section shows each system configuration when using the QB-V850ESX3H connected to a PC (a computer equipped with a USB port). Connection is possible even without optional products.

Connectors <9> to <13> differ depending on the target device to be emulated.

Figure 1-6. System Configuration (S Type)

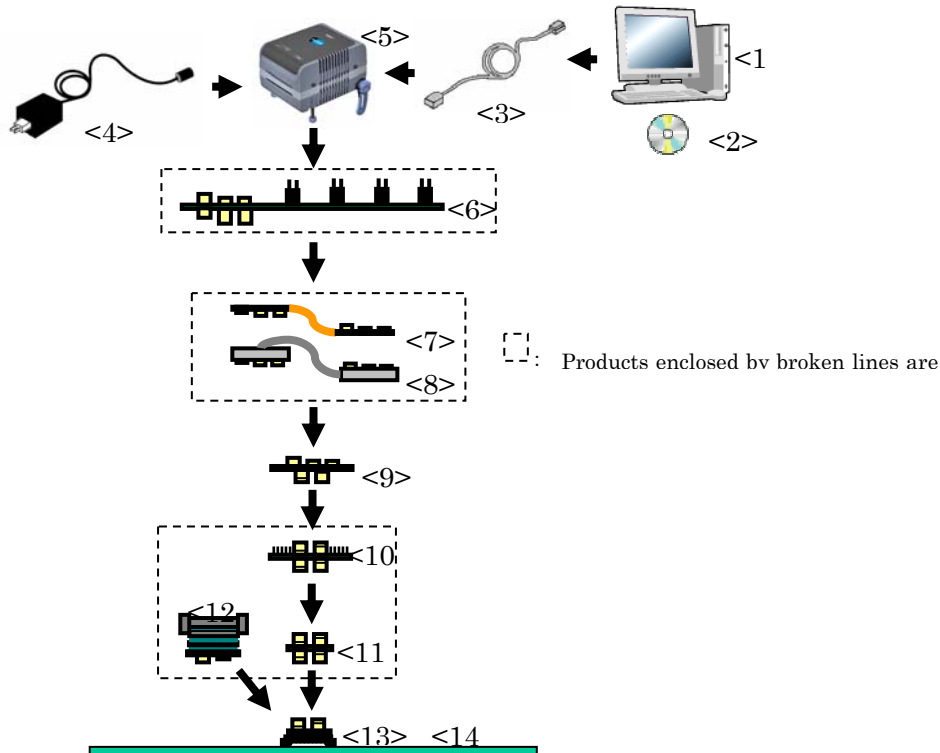

- | | |
|---|---|
| <1> Host machine: | Computer equipped with a USB port |
| <2> ID850QB Disk/Accessory Disk ^{Note 1} : | Debugger, USB drivers, manual, etc. |
| <3> USB interface cable: | Cable used for connecting QB-V850ESX3H to host machine |
| <4> AC adapter: | AC adapters classified by region |
| <5> QB-V850ESX3H: | This product |
| <6> Check pin adapter (optional): | Adapter used for monitoring waveforms with oscilloscope |
| <7> Extension probe flexible type (optional) | |
| <8> Extension probe coaxial type (optional) | |
| <9> Exchange adapter: | Adapter that performs pin conversion |
| <10> Check pin adapter (optional): | Adapter used for monitoring waveforms with oscilloscope ^{Note 2} |
| <11> Space adapter (optional): | Adapter used for height adjustment ^{Note 2} |
| <12> Mount adapter (optional): | Adapter used for mounting target device |
| <13> Target connector: | Connector to be soldered to target system |
| <14> Target system | |

Notes 1. Download the device file from the NEC Electronics website.

<http://www.necel.com/micro/en/development/index.html>

2. If both <10> and <11> are used, connection sequence of <10> and <11> may be reversed.

Remark For notes on target system design and package drawings, refer to **[Related Content]** on the following URL.

<http://www.necel.com/micro/en/development/asia/v850/icemulator.html>

Figure 1-7. System Configuration (T Type)

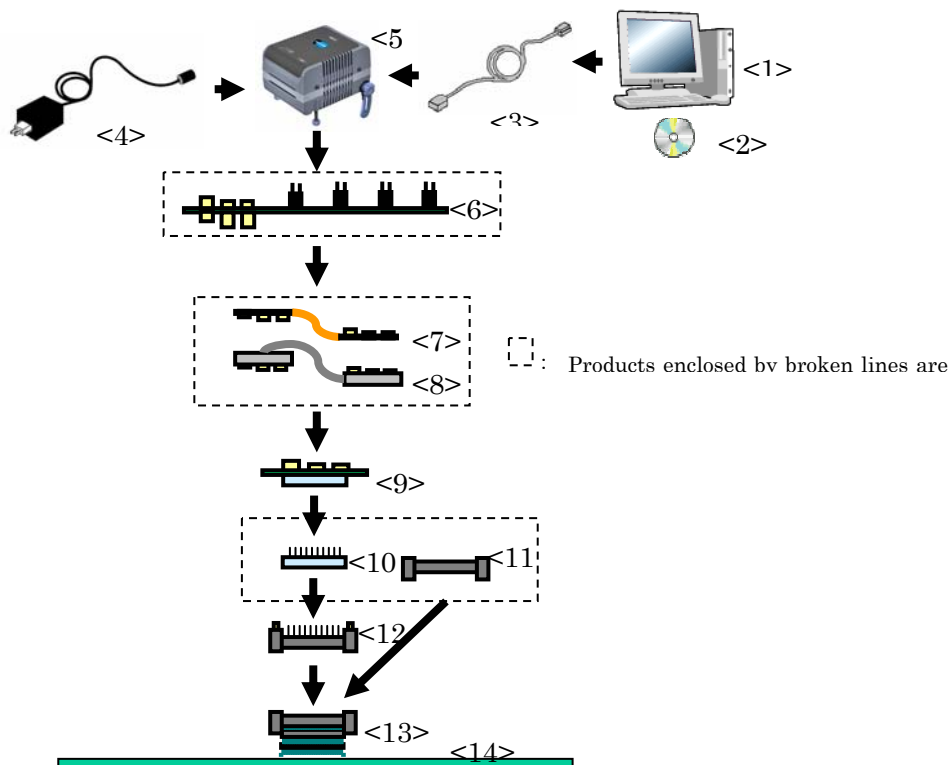

- <1> Host machine: Computer equipped with a USB port
- <2> ID850QB Disk/Accessory Disk^{Note}: Debugger, USB drivers, manual, etc.
- <3> USB interface cable: Cable used for connecting QB-V850ESX3H to host machine
- <4> AC adapter: AC adapters classified by region
- <5> QB-V850ESX3H: This product
- <6> Check pin adapter (optional): Adapter used for monitoring waveforms with oscilloscope
- <7> Extension probe flexible type (optional)
- <8> Extension probe coaxial type (optional)
- <9> Exchange adapter: Adapter that performs pin conversion
- <10> Space adapter (optional): Adapter used for height adjustment
- <11> Mount adapter (optional): Adapter used for mounting target device
- <12> YQ connector: Connector used for connecting emulator
- <13> Target connector: Connector to be soldered to target system
- <14> Target system

Note Download the device file from the NEC Electronics website.

http://www.necel.com/micro/index_e.html

Remark For notes on target system design and package drawings, refer to **[Related Content]** on the following URL.

<http://www.necel.com/micro/en/development/asia/v850/icemulator.html>

Table 1-3. List of Probe/Connector for Each Target Device (S Type)

No.	Name	Target Device to Be Emulated	
		V850E/SJ3-H (144-pin GJ)	V850E/SK3-H (176-pin GM)
<6>	Check pin adapter	QB-144-CA-01(sold separately)	なし
<7>	Extension probe (flexible type)	QB-144-EP-02S(sold separately)	QB-208-EP-02S(sold separately)
<8>	Extension probe (coaxial type)	QB-144-EP-01S(sold separately)	なし
<9>	Exchange adapter	QB-144GJ-EA-01S(sold separately) ^{Notes}	QB-176GM-EA-02S (sold separately) ^{Notes}
<10>	Check pin adapter	QB-144-CA-01S(sold separately)	QB-176-CA-01S(sold separately)
<11>	Space adapter	QB-144-SA-01S(sold separately)	QB-176-SA-01S(sold separately)
<12>	Mount adapter	QB-144GJ-MA-01S(sold separately)	QB-176GM-MA-01S(sold separately)
<13>	Target connector	QB-144GJ-TC-01S(sold separately) ^{Notes}	QB-176GM-TC-01S (sold separately) ^{Notes}

Table 1-4. List of Probe/Connector for Each Target Device (T Type)

No.	Name	Target Device to Be Emulated	
		V850E/SJ3-H (144-pin GJ)	V850E/SJ3-H (144-pin GJ)
<6>	Check pin adapter	QB-144-CA-01(sold separately)	なし
<7>	Extension probe (flexible type)	QB-144-EP-02S(sold separately)	QB-208-EP-02S(sold separately)
<8>	Extension probe (coaxial type)	QB-144-EP-01S(sold separately)	なし
<9>	Exchange adapter	QB-144GJ-EA-01T(sold separately) ^{Notes}	QB-176GM-EA-02T(sold separately) ^{Notes}
<10>	Space adapter	QB-144GJ-YS-01T(sold separately)	QB-176GM-YS-01T(sold separately)
<11>	Mount adapter	QB-144GJ-HQ-01T(sold separately)	QB-176GM-HQ-01T(sold separately)
<12>	YQ connector	QB-144GJ-YQ-01T(sold separately) ^{Notes}	QB-176GM-YQ-01T(sold separately) ^{Notes}
<13>	Target connector	QB-144GJ-NQ-01T(sold separately) ^{Notes}	QB-176GM-NQ-01T(sold separately) ^{Notes}

Note These accessories are supplied depending on the part number ordered (Refer to 1.5 Package Contents).

1.5 Package Contents

The following items have been placed in the QB-V850ESX3H packing box. Please check the contents.

Products supplied with QB-V850ESX3H-ZZZ

- 1: QB-V850ESX3H
- 2: USB interface cable
- 3: ID850QB Disk (CD-ROM)
- 4: Accessory Disk (CD-ROM)
- 5: IECUBE Setup Manual (J/E)
- 6: User registration (Guarantee card and software contract in one)
- 7: Simple flash memory programmer QB-MINI2
- 8: Probe holder
- 9: Parts board (for clock)

Products supplied with QB-V850ESX3H-S144GJ

- 1 to 9
- | | | |
|-----|------------------|-----------------|
| 10: | Exchange adapter | QB-144GJ-EA-01S |
| 11: | Target connector | QB-144GJ-TC-01S |

Products supplied with QB-V850ESX3H-T144GJ

- 1 to 9
- | | | |
|-----|------------------|-----------------|
| 10: | Exchange adapter | QB-144GJ-EA-01T |
| 11: | YQ connector | QB-144GJ-YQ-01T |
| 12: | Target connector | QB-144GJ-NQ-01T |

Products supplied with QB-V850ESX3H-S176GM

- 1 to 9
- | | | |
|-----|------------------|-----------------|
| 10: | Exchange adapter | QB-176GM-EA-02S |
| 11: | YQ connector | QB-176GM-TC-01S |

Products supplied with QB-V850ESX3H-T176GM

- 1 to 10
- | | | |
|-----|------------------|-----------------|
| 11: | Exchange adapter | QB-176GM-EA-02T |
| 12: | YQ connector | QB-176GF-YQ-01T |
| 13: | Target connector | QB-176GF-NQ-01T |

1.6 AC Adapter for IECUBE

The specifications of the AC adapter for IECUBE differ depending on the region of use.
Be sure to use an AC adapter corresponding to the region of use.

The IECUBE is not provided with an AC adapter.
It must be purchased separately.

Table 1-5. Part Numbers of AC Adapter for IECUBE Classified by Region

Product	Destination (Region) ^{Notes 1, 2}	Part Number ^{Note 3}
AC adapter (sold separately)	Japan	QB-COMMON-PW-JP
	USA	QB-COMMON-PW-EA
	China	QB-COMMON-PW-CH
	Hong Kong	QB-COMMON-PW-HK
	South Korea	QB-COMMON-PW-KR
	Singapore	QB-COMMON-PW-SG
	Taiwan	QB-COMMON-PW-TW

Notes 1. Products are shipped only on order from each region.

2. Contact a distributor or an NEC Electronics sales representative for information on regions other than the above.

3. Only the AC adapter usable in each region can be ordered.

CHAPTER 2 SETUP PROCEDURE

This chapter explains the QB-V850ESX3H setup procedure.

Setup can be completed by performing installation/setup in the order in which it appears in this chapter.

Perform setup along the lines of the following procedure.

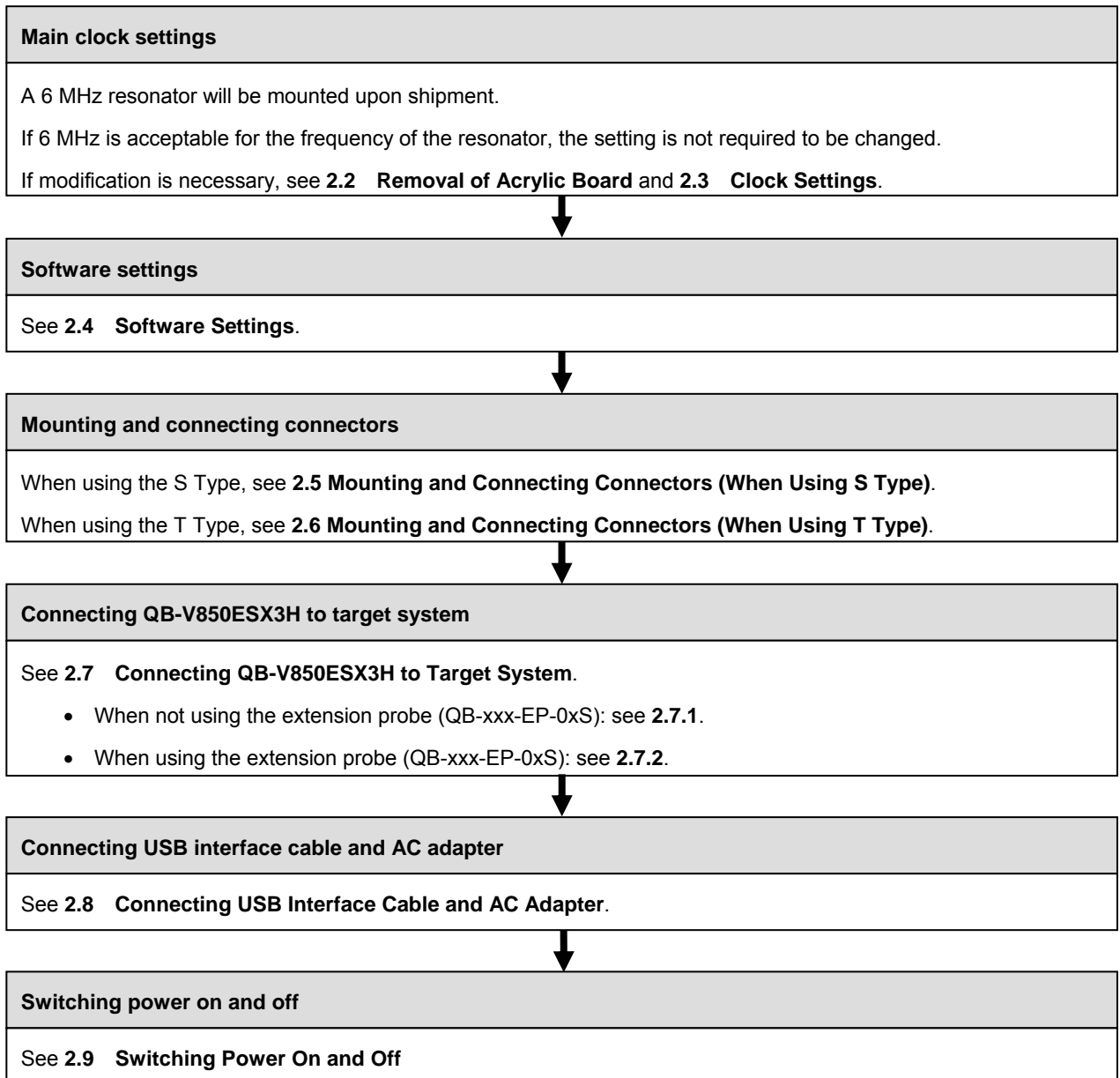

2.1 Names and Functions of Hardware

Figure 2-1. Names of Parts of QB-V850ESX3H

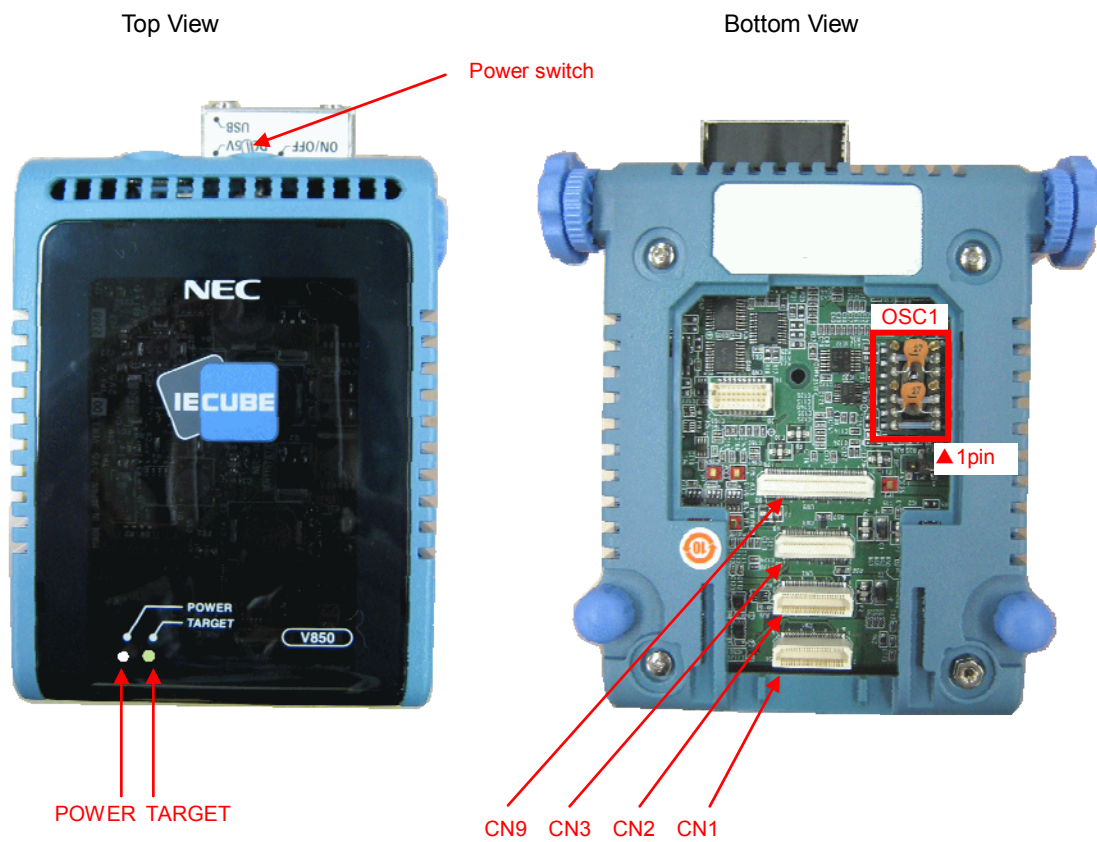

(1) CN1, CN2, CN3, CN9

These connectors are used to connect the exchange adapter or extension probe.

(2) OSC (Parts board connector)

This connector is used to mount an oscillator for the main clock.

(For details, refer to **2.3 Clock Settings**.)

(3) POWER (Red LED)

This is an LED that shows whether or not the power supply of the QB-V850ESX3H is switched on.

LED State	QB-V850ESX3H State
Lit	Power switch ON
Not lit	Power switch OFF or AC adapter not connected to QB-V850ESX3H
Blinking	Internal error occurred (Contact an NEC Electronics sales representative or distributor)

(4) TARGET (Green LED)

This is an LED that shows whether or not the power supply of the target system is switched on.

LED State	Target System State
Lit	Target system power supply ON
Not lit	Target system power supply OFF or target system not connected

(5) Power switch

This is the power switch of the QB-V850ESX3H.
It is OFF at shipment.

2.2 Removal of Acrylic Board

To change the jumper or clock setting, the acrylic board on the bottom of the QB-V850ESX3H must be removed. The acrylic board can be removed by lifting it up.

Figure 2-2. Acrylic Board Removal Method

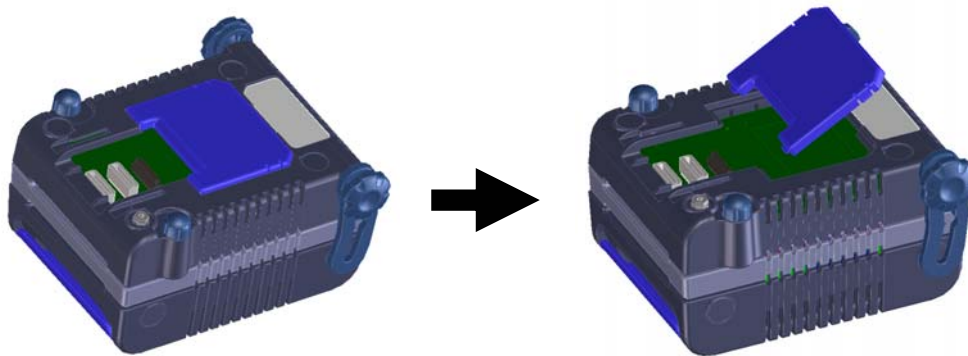

2.3 Clock Settings

The main clock is generated from the oscillator mounted in the QB-V850ESX3H. It oscillates at 4 MHz with the factory setting. To change the oscillation clock frequency, perform settings with the following procedures.

Caution This product does not support clock input from the target system.

- (1) Removing parts board on MAIN CLOCK socket
- (2) Solder a resonator and a capacitor to the parts board supplied with the QB-V850ESX3H.

The setting is as follows.

Pins 1 and 14: Be sure to short these pins.

Pins 2 and 13: Connect a capacitor.

Pins 3 and 12: Connect a resonator.

Pins 4 and 11: Leave open.

Pins 5 and 10: Connect a capacitor.

Pins 6 and 9: Be sure to short these pins.

Pins 7 and 8: Be sure to leave open.

Figure 2-3. Setting Parts Board

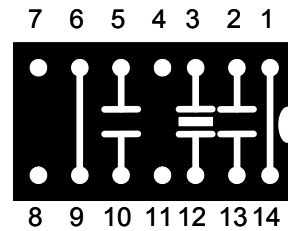

- (3) Insert the parts board into MAIN CLOCK socket of the QB-V850ESX3H.

Figure 2-4. Inserting Parts Board

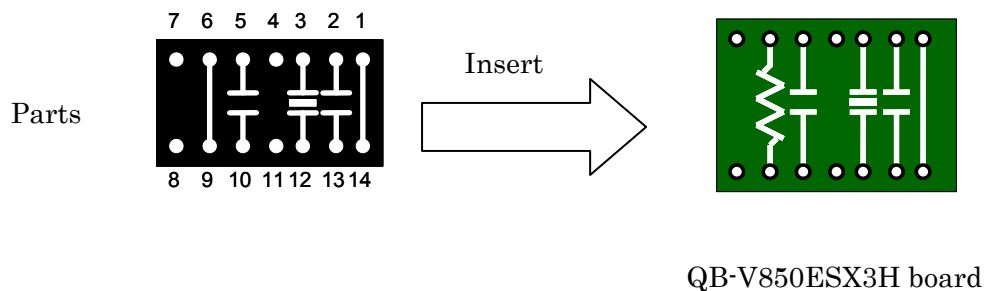

2.4 Software Settings

2.4.1 When using ID850QB as debugger

Be sure to use ID850QB of V3.51 or later.

For details of setting up ID850QB, refer to the **V850 Series Integrated Debugger ID850QB Operating Precautions** supplied with the debugger (ID850QB).

2.4.2 When using other than ID850QB (MULTI™, etc.) as debugger

Refer to the user's manual of the debugger used and the **V850 IECUBE Setup Manual** (supplied).

2.5 Mounting and Connecting Connectors (When Using S Type)

This section describes the methods for connecting the QB-V850ESX3H to the target system when using the S Type.

Make connections with both the QB-V850ESX3H and target system powered off.

The following abbreviations are used in this section.

- TC: Target connector
- EA: Exchange adapter
- MA: Mount adapter
- CA: Check pin adapter
- SA: Space adapter

2.5.1 Mounting TC to target system

- (1) Apply cream solder to the foot pattern of the target system for mounting an IC.
- (2) A circular projection is at the center of the bottom side of the TC (refer to **Figure 2-5**). Sparingly apply two-liquid hardening epoxy adhesive (type that hardens in 15 to 30 minutes is recommended) to temporarily secure the connector at the specified position on the target system. At this time, match the position of pin 1 (position where a corner is cut) with the position of pin 1 from the target system.
- (3) Soldering condition of TC
 - (a) Reflow soldering
 - At 245°C for a maximum of 20 seconds (main heating)
 - (b) Manual soldering
 - At 330°C for a maximum of 3 seconds (per pin)

Figure 2-5. TC Projection

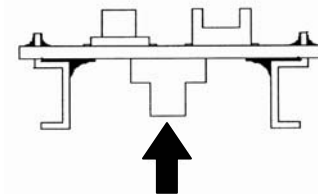

- (4) Precautions on flux splatter

If the solder flux splatters when the connector is soldered, faulty contact may occur. Be sure to cover the upper part of the connector with aluminum foil. Do not clean the connector because the flux solvent may remain inside the connector.

2.5.2 Inserting EA into TC

Match the pin 1 position of the EA, MA, CA, or SA to the pin 1 position of the TC and insert it (corner cuts match in both).

- (a) When inserting or removing, hold down the TC with your fingers so that there is no force on the TC.
- (b) When inserting or removing, be careful of the direction of wiggling (refer to **Figure 2-6**).

As a tool when removing, insert some kind of thin non-conductive material such as a wooden stick in between the TC and EA and wiggle it in the direction shown in **Figure 2-6** while slowly removing. Be careful since the connector will be damaged if this is done in the wrong direction.

Figure 2-6. Inserting and Removing

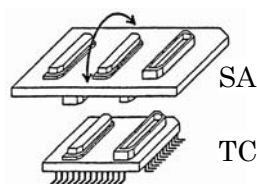

2.5.3 Precautions for handling TC, EA, MA, CA, and SA

- (1) Cause of faulty contact of connector
 - (a) If flux gets inside the connector when the TC is soldered

It is easy for flux to get inside of the connector. Clean the connector several times with a solvent such as alcohol if flux gets inside.

If conduction is still unstable, repeat cleaning.
 - (b) If dust gets inside the connector

Faulty contact occurs if dust such as a thread gets inside the connector. Remove dust with a brush.
 - (c) Cautions on using the CA or SA

When the CA or SA is used, a fractional delay time of signal propagation and a little capacitance are generated as a result of inserting the adapter. Make a thorough evaluation by connecting the target system.

- (2) Cautions on inserting and removing the connector
 - (a) When inserting or removing the connector, be sure to hold down the lower (mating) connector or board with your fingers.
 - (b) Before inserting a connector, make sure that the connectors are correctly positioned.

If the connector is inserted incorrectly positioned, it may be damaged.
 - (c) When removing a connector, insert some kind of thin non-conductive material such as a wooden stick beneath the connector to protect the board from being damaged. Do not remove the connector all at once. Remove it slowly.

If only a metallic object such as a screwdriver is available, wind a soft cloth around its tip.

- (3) Check pin adapter QB-144-CA-01

The check pin adapter QB-144-CA-01 is an optional product for IECUBE, and can be used to measure the waveform between IECUBE and the target system.

Since the pins on the QB-144-CA-01 do not correspond to the pin layout in each device, the pin header cover must be mounted according to the device to be used.

For mounting methods of the pin header cover, refer to **[Related Content]** on the following webpage.

URL: <http://www.necel.com/micro/english/iecube/index.html>

- (4) Check pin adapter (QB-xxx-CA-01S)

When using a check pin adapter (QB-xxx-CA-01S), connect a extension probe (QB-xxx-EP-0xS) (sold separately).

2.5.4 Precautions for mounting IC using MA

- (1) Confirm that there is no weld flash in the resin (sealant part) of the IC. If there is weld flash, remove it using a knife or the like.
- (2) Confirm that there is no weld flash breaking or bending of IC leads. In particular, confirm the planarity of IC leads. If there is abnormality in the planarity, correct that portion.
- (3) Viewing the contact pins on the bottom of the MA (IC mounting part) from the top, if there are foreign bodies on them, remove them using a brush or the like.
After confirming (1) to (3), fit the IC to the bottom of the MA. Also fit the top (cover) of the MA.
- (4) Put the supplied M2 × 6 mm screws in the four accessory holes on the top (cover) of the MA and fasten the screws in opposite corners. At that time, use either the dedicated screwdriver that is supplied or a torque driver to fasten them equally in turn with a tightening torque of 0.054 Nm (MAX.). Since the contact is poor if tightening is too great, once you have lightly fastened the screws on the top of the MA, tighten them again.
- (5) Depending on the use environment, when starting up a device that has been left for a long time, starting it may be difficult. In this case, loosen the screws slightly and then retighten them.
- (6) If startup still is difficult after (5) above, check (1) to (3) again.
- (7) Tightening the screws on the top of the MA too much may give rise to cracks in the molded part of the MA (plastic part) and bend the mold into a bowed shape, making contact poor.
- (8) After soldering the MA, do not perform cleaning by flux immersion or vapor.

- (2) Fasten YQ to the TC on the target system using the supplied YQGUIDE. Fasten the screws equally in the four corners using the supplied flat-blade screwdriver or a torque driver. The tightening torque of YQGUIDE is 0.054 Nm (MAX.). Too great tightening causes bad connections. Four screws for fitting to the MA (M2 x 10 mm / 4 units) are included with YQ.

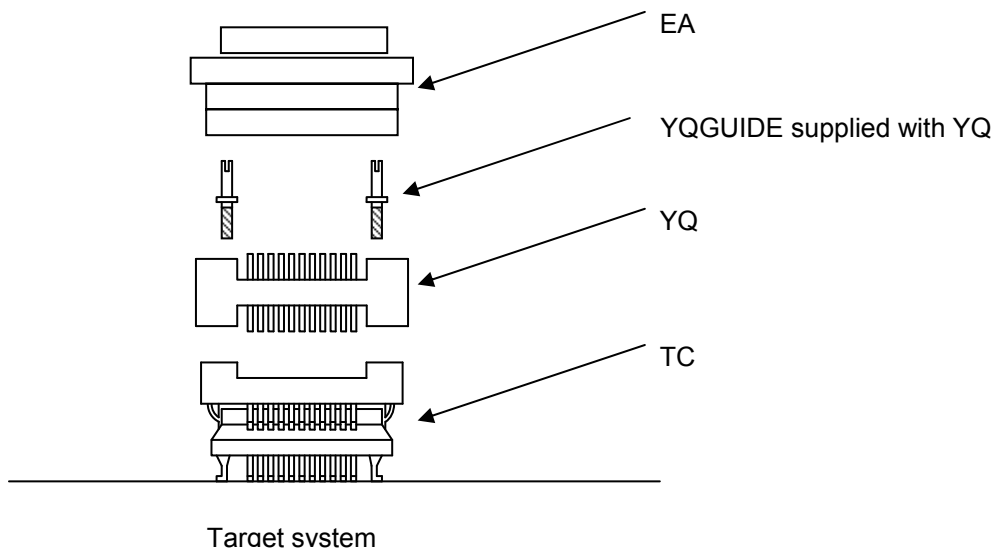

2.6.3 Inserting EA into YQ

Match the pin 1 position of the YQ or SA (corner cuts match in both) to the pin 1 position of the EA and insert it.

- When inserting or removing, press on the TC, YQ, and SA with a finger so that there is no force on the TC.
- When inserting or removing, be careful of the direction of wiggling.

As a tool when removing, insert some kind of thin non-conductive material such as a wooden stick between the YQ (SA) and EA and wiggle it while slowly removing. Be careful since the connector will be damaged if this is done in the wrong direction.

2.6.4 Precautions for handling TC, YQ, and SA

- (1) When taking the TC from the box, press down on the body and take out the sponge first.
- (2) Since the pins of the YQ are thin and easily bent, be careful. When inserting it in the TC, confirm that there are no bent pins.
- (3) When screwing a YQ soldered to a board to the TC, fasten the screws in four places in turn using a #0 or #1 Phillips precision screwdriver or torque driver after tentatively tightening them. Fix the torque at 0.054 Nm (MAX.). If just one place is overtightened, it may cause poor contact. Moreover, a board being connected to the YQ must have accessory holes in prescribed positions (4 places: $\phi 2.3$ mm or $\phi 3.3$ mm). The $\phi 3.8$ mm or $\phi 4.3$ mm that is the screw head size is an area where wiring is prohibited.
- (4) In YQ and SA removal, since there is a danger of YQ pins being bent or broken when prying and wiggling, remove them gradually using a flatbladed screwdriver from four directions. Moreover, to connect and use the YQ and SA, screw the YQ to the TC according to the YQGUIDE (included with the YQ) using a 2.3 mm flatbladed screwdriver and then connect it to the SA. Fix the torque at 0.054 Nm (MAX.). If even one place is overtightened, it may cause poor contact.
- (5) For the TC, YQ, and SA, since there is a danger that cleaning fluid on the structure will remain in the connector, do not perform cleaning.
- (6) TC, IC, and YQ cannot be used in combination.
- (7) An TC/YQ system cannot be used in an environment of vibrations or shocks.

- (8) It is assumed that this product will be used in system development and evaluation. Moreover, when used in Japan, these are not satisfactory for domestic electrical safety rules or EMI requirements.
- (9) Since there are rare cases of shape change if the box is left for a long time in a place where it is 50°C or higher, for safekeeping, store it in a place where it is no higher than 40°C and direct sunlight does not hit it.
- (10) For details about handling the TC, YQ, and SA, see the NQPACK series technical materials at the website of Tokyo Eletech Corporation.
Tokyo Eletech Corporation website: <http://www.tetc.co.jp/>
- (11) The check pin adapter QB-144-CA-01 is an optional product for IECUBE, and can be used to measure the waveform between IECUBE and the target system.
Since the pins on the QB-144-CA-01 do not correspond to the pin layout in each device, the pin header cover must be mounted according to the device to be used.
For mounting methods of the pin header cover, refer to **[Related Content]** on the following webpage.
URL: <http://www.necel.com/micro/en/development/asia/v850/icemulator.html>

2.6.5 Precautions for mounting IC using TC and MA

- (1) Confirm that there is no weld flash in the resin (sealant part) of the IC. If there is weld flash, remove it using a knife or the like.
- (2) Confirm that there is no weld flash breaking or bending of IC leads. In particular, confirm the planarity of IC leads. If there is abnormality in the planarity, correct that portion.
- (3) Viewing the TC contact pins from the top, if there are foreign bodies on them, remove them using a brush or the like.
After confirming (1) to (3), fit the IC to the TC. Also fit the MA.
- (4) Put the supplied M2 × 6 mm screws in the four accessory holes of the MA and fasten the screws in opposite corners. At that time, use either the dedicated screwdriver that is supplied or a torque driver to fasten them equally in turn with a tightening torque of 0.054 Nm (MAX.). Since the contact is poor if tightening is too great, once you have lightly fastened the MA screws, tighten them again.
- (5) Depending on the use environment, when starting up a device that has been left for a long time, starting it may be difficult. In this case, loosen the screws slightly and then retighten them.
- (6) If startup still is difficult after (5) above, check (1) to (3) again.
- (7) Tightening the screws of the MA too much may give rise to cracks in the molded part of the MA (plastic part) and bend the mold into a bowed shape, making contact poor.
- (8) After soldering the TC, do not perform cleaning by flux immersion or vapor.

2.7 Connecting QB-V850ESX3H to Target System

2.7.1 When not using extension probe (QB-xxx-EP-0xS)

The QB-V850ESX3H can be connected to the target system without using an extension probe.

Adjust the height by using the spacer at the rear part of the QB-V850ESX3H, so that no stress is applied to the exchange adapter, the target connector, and other connectors.

Sufficiently insulate the target system.

Figure 2-7. Connection Without Extension Probe

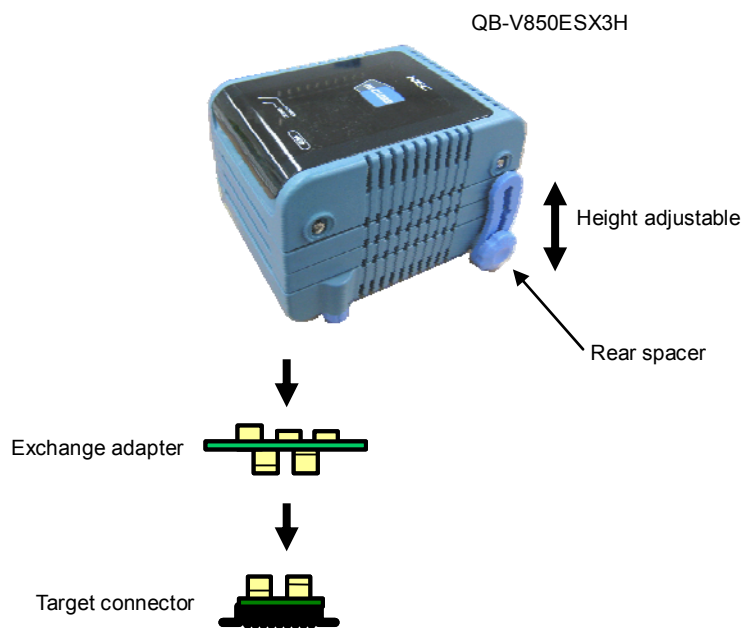

Remark The connector shown in the above figure is the connector used with the S Type. When used with the T Type, read this connector as that of the T Type.

2.7.2 When using extension probe (QB-xxx-EP-0xS)

When using the extension probe (QB-xxx-EP-0xS), connect the QB-V850ESX3H to the target system using the following procedure.

(a) Connecting probe holder

Use the probe holder (supplied with the QB-V850ESX3H) to connect the extension probe to the QB-V850ESX3H, as shown below.

Figure 2-8. Using Probe Holder

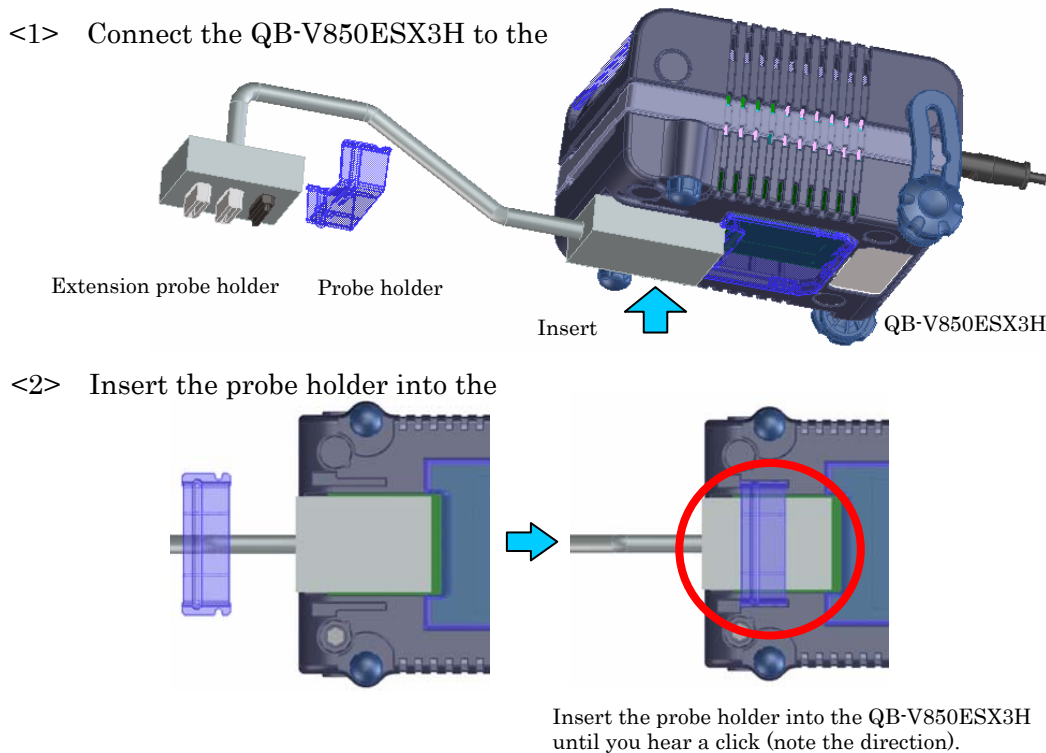

(b) Connection of extension probe GND wire

There are three GND wires in the extension probe. Connect them to the QB-V850ESX3H and target system.

<1> Fasten the GND wire on the QB-V850ESX3H side of the extension probe to the nut on the bottom of the QB-V850ESX3H using a #0 or #1 Phillips precision screwdriver (connection of B to A in **Figure 2-9**).

<2> Next insert the connector on the top of the extension probe into the connector at the opening on the bottom of the QB-V850ESX3H from below being careful of the insertion direction (connection of C in **Figure 2-9** to QB-V850ESX3H).

Figure 2-9. GND Wire

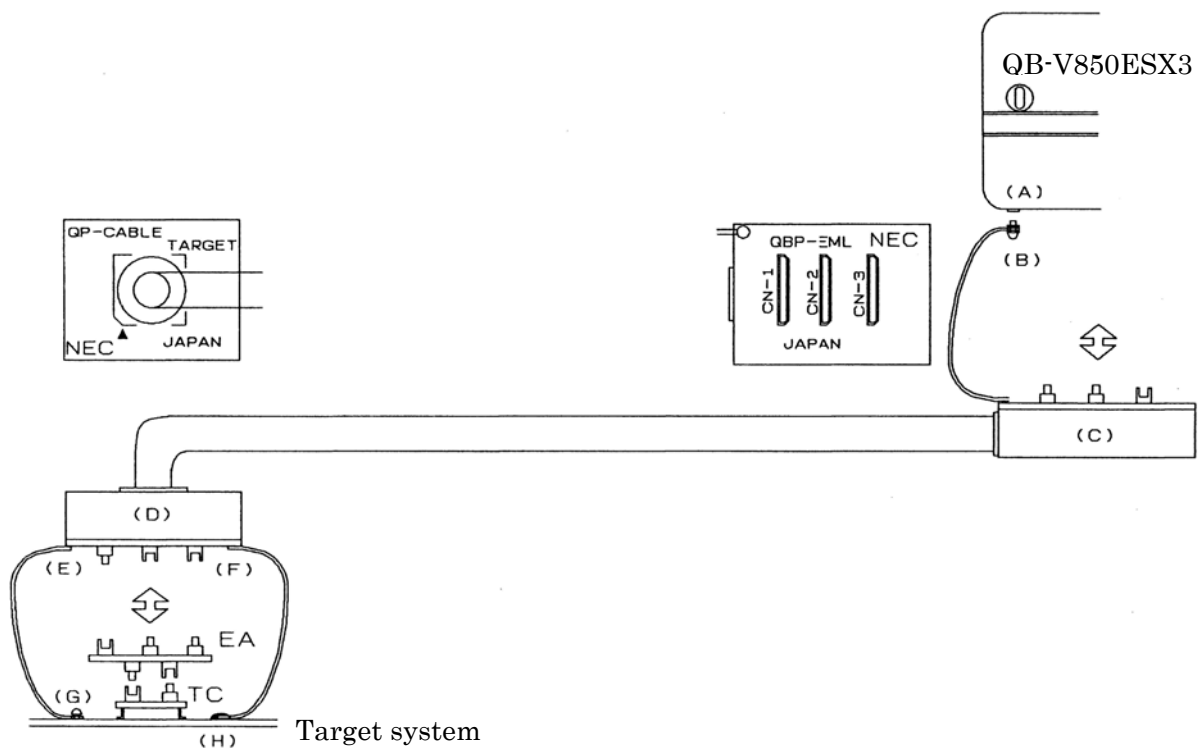

Remark The connector shown in the above figure is the connector used with the S Type. When used with the T Type, read this connector as that of the T Type.

- <3> Connect two GND wires on the target system side of the extension probe to the target system GND.
- <4> If a pin or screw is fastened to the target system GND, remove the transparent terminal cover on the end of the GND wire and fasten the Y type pin of the GND wire to the target system (G in **Figure 2-9**). If the GND on the target system is an exposed pad, likewise fasten the Y type pin to the pad on the target system by soldering (H in **Figure 2-9**) (recommended soldering iron temperature setting: 300°C).
- <5> If the target system has only one GND, connect only one of the GND wires of the extension probe. Cut off the other GND wires with a nipper or leave it as is without removing the pin cover.

<6> Since the length of the GND wire below the head (insulated part) is approximately 60 mm, there must be at least a GND to which it can be connected to within the range of the three approximately 60 mm radius sections of the target system for connecting the extension probe, as shown in **Figure 2-10**. The GND wire of the extension probe is soldered to positions J and K in **Figure 2-10**. To connect it to position L, remove the wire soldered to J or K and then solder it to L.

Figure 2-10. Where GND Wire Can Be Connected

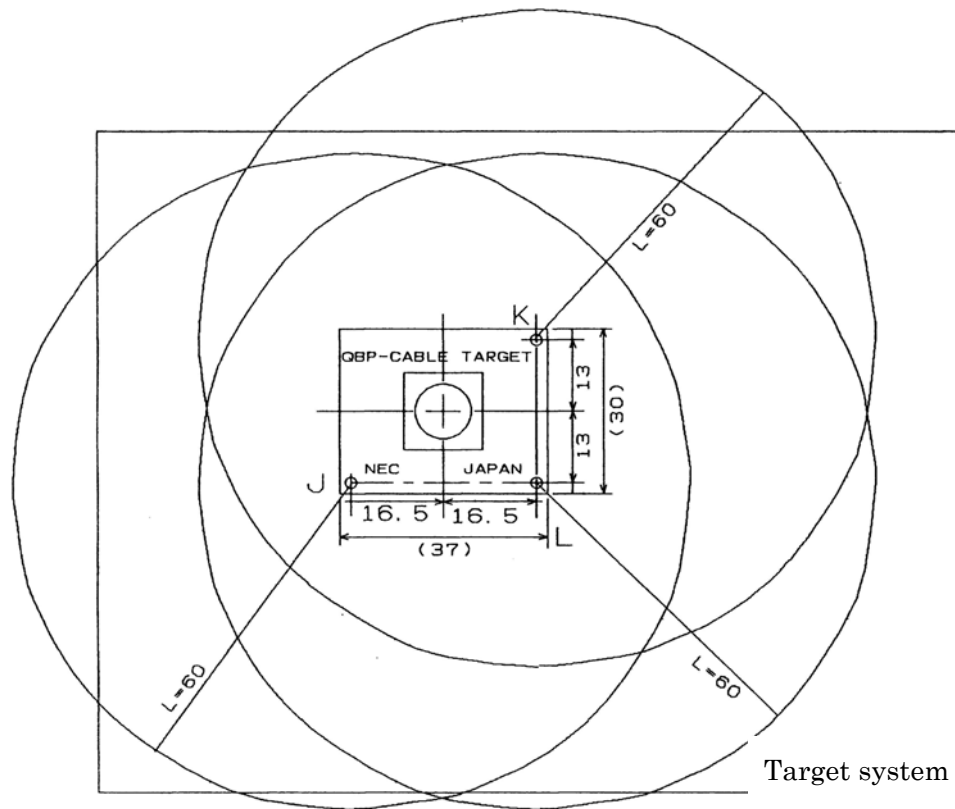

(c) Ensuring isolation

When connecting the target system to the QB-V850ESX3H using an extension probe, adjust the height using the front spacer or rear spacer of the QB-V850ESX3H to ensure isolation from the target system.

Figure 2-11. Connection Using Emulation Probe

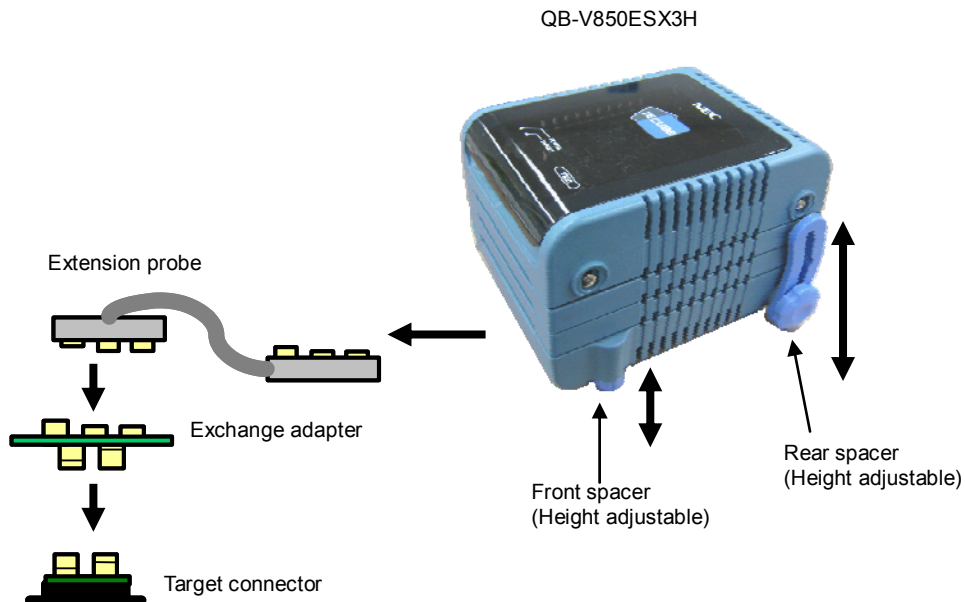

Remark The connector shown in the above figure is the connector used with the S Type. When used with the T Type, read this connector as that of the T Type.

(d) Cautions related to extension probe

The following cautions pertain to using the extension probe.

- <1> Be careful that stress of the extension probe is not placed on the target connector. Moreover, when removing the extension probe, remove it slowly while holding down on the exchange adapter with a finger so that there is no stress on the target connector.
- <2> Be sure to connect the GND wire of the extension probe to the QB-V850ESX3H and the target system. If not, the impedance of the cable becomes unstable, resulting in the lowering of signal transmission characteristics or distortion of the output waveform for an input waveform.
- <3> When using the external bus interface with the extension probe, add a data wait state by increasing the set value of the DWC register by one.

2.8 Connecting USB Interface Cable and AC Adapter

Plug the USB interface cable supplied with the QB-V850ESX3H into the USB connector of the host machine, and plug the other side into the USB connector on the rear of the QB-V850ESX3H.

Plug the AC adapter supplied with the QB-V850ESX3H into a receptacle and plug the other side into the power supply connector on the rear of the QB-V850ESX3H.

For QB-V850ESX3H connector positions, see **Figure 2-12**.

Figure 2-12. Connector Positions

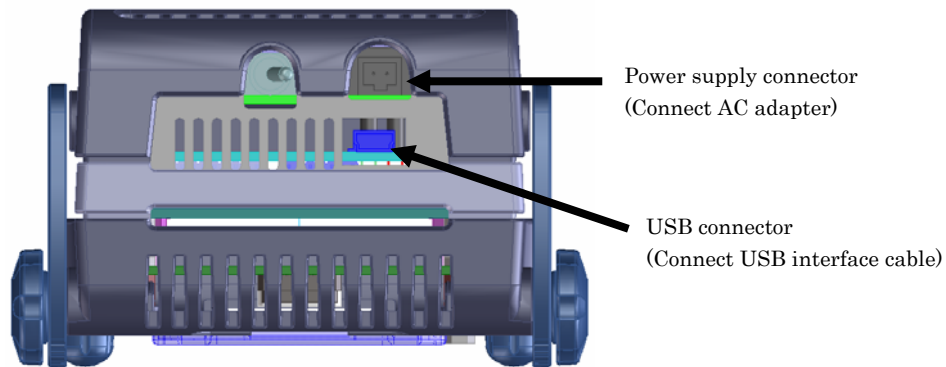

2.9 Switching Power On and Off

Be sure to switch the power on and off according to the following procedures.



- Switching power on
 - <1> QB-V850ESX3H power on
 - <2> Target system power on^{Note}
 - <3> Debugger startup
- Switching power off
 - <1> Debugger termination
 - <2> Target system power off^{Note}
 - <3> QB-V850ESX3H power off

Note In the procedures, <2> is unnecessary if the target system is not connected.

Caution If the wrong sequence was used for the operation, the target system or QB-V850ESX3H may fail.

CHAPTER 3 SETTINGS AT PRODUCT SHIPMENT

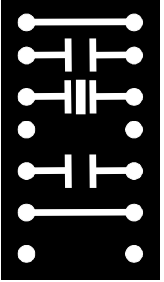
Table 3-1. Settings at Shipment

Item	Setting	Remarks
Parts board		<p>Pins 3 to 12 are equipped with 4 MHz resonators. Pins 2 to 13 and 5 to 10 are equipped with 27 pF capacitors. The frequency can be changed by mounting an oscillator onto the component board included with IECUBE.</p> <p>For details, refer to 2.3 Clock Settings.</p>
Power switch		<p>Set to OFF at shipment.</p>

CHAPTER 4 NOTES

4.1 Cautions Regarding Differences Between Actual Device And Emulator

When debugging is performed with QB-V850ESX3H connected to the target system, QB-V850ESX3H performs emulation as if the actual device operates in the target system, although operations of the actual device and QB-V850ESX3H differ in the following points. Therefore, the user is responsible for using the actual device for the final evaluation before starting mass production and judging its applicability.

4.1.1 Real time operation in 1MB or upper internal ROM area

The real time operation can not be done, because the time of execution and data access is different from actual device in area from 0x10_10000 to 0x17_FFFF. The memory in this area is connected with external bus in IECUBE. The following setting is necessary to access this area, in case reset is input when program is running. .

- BSC register : bit1="1", bit0="0"
- DWC0 register ^{Note} : bit2="0", bit1="0", bit0="0"^注
- AWC register : bit1="0", bit0="0"
- BCC register : bit1="0"

Note DWC0 setting is following, when the frequency of CPU is 32MHz or higher and EXIMC register is set to 0x01.

- DWC0 register : bit2="0", bit1="0", bit0="1"

.

4.1.2 Operation after power application to target system

The target device mounted in the target system starts program execution when reset is released after power application. With QB-V850ESX3H, however, the program will not be executed until manipulation to start the program downloaded with the debugger is performed.

QB-V850ESX3H can download and execute objects even before their initial value information of a variable is ROMized, but the actual device does not operate normally if the objects have not been ROMized. For details on ROMization, refer to the user's manual of the compiler.

4.1.3 Oscillator

QB-V850ESX3H does not support clock input from the oscillator in the target system. The operating clock frequency may therefore vary between when the target device is mounted and when QB-V850ESX3H is connected.

4.1.4 Pin characteristics

Since the connectors, adapters and circuit board are placed between QB-V850ESX3H and the target system, unlike when the target device is mounted in the target system, the electrical characteristics of the pins differ. In particular, note that the A/D converter conversion results can easily be affected.

4.1.5 Notes on ROM correction function

QB-V850ESX3H does not support emulation of the ROM correction function. To use this function, make an evaluation by using the target device.

4.1.6 Notes on flash self programming function

The flash self programming function cannot be emulated. To use this function, make an evaluation by using an on-chip debug emulator or the target device.

4.1.7 Notes on DBTRAP instruction

The DBTRAP instruction cannot be used in the user program because it is used for software breaks.

4.1.8 On-chip debug function

Emulation of the on-chip debug function is not possible.

4.1.9 Current consumption

Current consumption of the QB-V850ESX3H differs from that of an actual device.

Current consumption may be up to about 80 mA. The same amount will be consumed when in standby mode.

4.1.10 Cautions when using extension probe

When an extension probe is used, signal response will be delayed by about 5 ns. Consequently, when an external bus is used, numerous wait operations will be required in contrast to the actual device..

4.1.11 RAM retention flag

RAMF register can not be emulated.

4.2 Notes On Debugging

4.2.1 Notes on Non-map Break

If a program is fetched from an area not used by a program (unused area) with an emulator, a non-map break usually occurs. However, a non-map break does not occur in the first 16-byte space of each unused area (refer to **Figure 4-1**).

4.2.2 PSC Register Access

Data is written to the PSC register in the following sequence. If a software break is set to the NOP instruction immediately after the register has been accessed, the debugger hangs up.

Example:

```
mov 0x2,r1
st.b r1,prcmd
st.b r1,psc
```

nop ← Debugger hangs up if a software break is set here.

nop ← There is no problem if a software break is set here or later.

To set a break immediately after the PSC register has been written, use a hardware break.

4.2.3 Notes on DBPC, DBPSW, and ECR Registers

The DBPC, DBPSW, and ECR registers cannot be accessed during a break.

If a value is written to any of these registers during a break, the written value is ignored.

If these registers are read, 0 is always read.

4.2.4 Notes on Trace Display Sequence

When the trace mode that displays the access history is used, the display sequence may be reversed.

- If read and write instructions are successively executed
- If a bit manipulation instruction that executes read-modify-write is executed (such as SET, NOT, or CLR)

In both the cases, the trace results of write and read are displayed in that order.

4.2.5 Notes on Starting Debugger

When the debugger is started, the following warning or error may occur depending on the setting of the debugger and the status of the target system. This is because the status of the target system is not in accordance with the setting of the debugger. If a warning or error occurs, check the status of the target system or the setting of the debugger.

It is recommended that the conversion adapter be connected to the QB-V850ESX3H even when the target system is not connected. If the conversion adapter is not connected, the value of the input port may not be correctly read.

Figure 4-1. Break at Fetching Unused Area

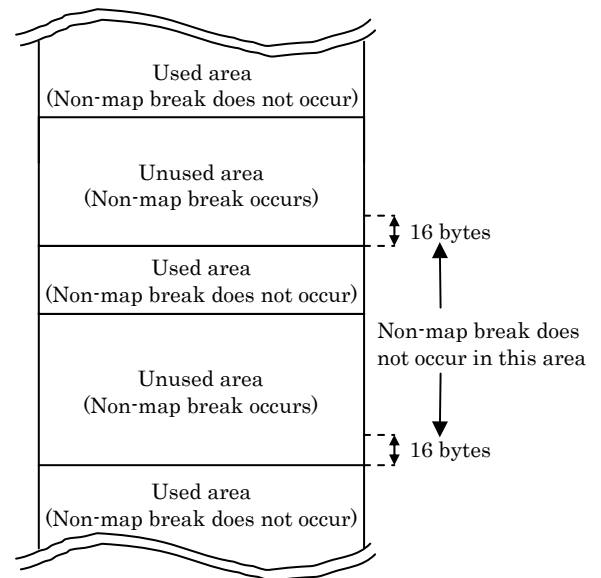

• ID850QB

Error No.	Error Message	"Target" Field of ID850QB Configuration Window		Target System Connection		Exchange Adapter		Target System Power	
		Connect	Not Connect	Connecte d	Not Connecte d	Us ed	Not Us ed	ON	OF F
Ff606	Check connection with the target and turn on power to the target.	√							√
Wf607	Check the connection of the conversion adapter.		√		√		√		√
Ff608	Disconnect the target.		√	√					√
Ff609	Turn off power to the target and disconnect the target.		√					√	

• MULTI

Error Message	"-tc" of 850eserv Start Option		Target System Connection		Exchange Adapter		Target System Power	
	With -tc	Without -tc	Connecte d	Not Connecte d	Use d	Not Use d	ON	OFF
Check the target power on. Or please delete "-tc" option.	√							√
Check the exchange adapter is connected.		√		√		√		√
Remove the target. Or please add "-tc" option and power on the target.		√	√					√
Power off and remove the target. Or please add "-tc" option.		√					√	

4.2.6 Simultaneously Executing Two Instructions When Hardware Break Is Set

If a hardware break is set at the first or the next of two instructions that are executed at the same time, the following phenomena may occur.

- Break occurs at a place different from where it has been set.
- The set break does not occur.

To prevent these phenomena, set a software break.

The conditions under which two instructions are simultaneously executed are shown on the following pages.

4.2.7 Operation during Break

Since various peripheral functions operate even during breaks in the in-circuit emulator, interrupts due to peripheral functions, generated during breaks, are suspended and, when re-executing after the breaks, execution may occur after processing of suspended interrupts. The watchdog timer counter, however, stops during the breaks.

The following peripheral functions can be stopped when using the peripheral break functions. When using the ID850QB, this setting can be made in the Configuration dialog box.

- 16-bit timer/counter TMQ
- 16-bit timer/counter TMP
- 16-bit timer/counter TMT
- 16-bit timer/counter TMM
- Watch timer
- Real time counter (RTC)
- A/D converter

4.2.8 When an Illegal Break Occurs during Program Execution in Internal RAM

An illegal break may occur when a peripheral I/O register is accessed during program execution in the internal RAM.

A non-map break occurs if all of the following conditions are satisfied, even if the program itself is correct.

A program is executed in the internal RAM area.

Data access for the internal RAM area is performed twice in succession.

An execution branches to the internal ROM area using a JR or JARL instruction immediately after the above successive data access, or one NOP instruction after the above successive data access.

In order not to generate the break, cancel the fail-safe break setting for the internal RAM in the debugger.

<When using ID850QB>

Click the [Detail] button in the Fail-safe Break field in the Configuration window and clear the check in the check box for "Internal RAM".

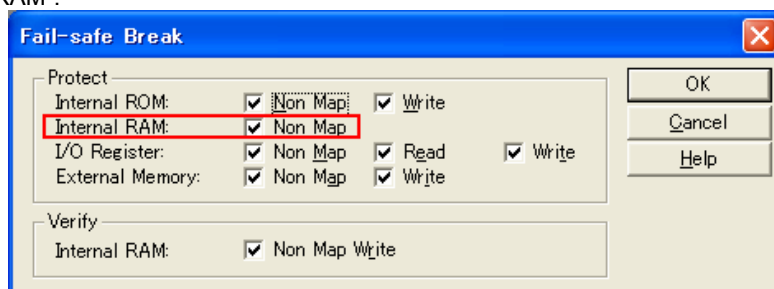

<When using MULTI>

Cancel the fail-safe break for "ramgrd" and "ramgrdv" using the Target flsf command.

4.2.9 Conflict between program execution for internal RAM and DMA transfer

If the following two operations are executed at the same time, the CPU may deadlock due to an internal bus conflict.

- Instruction for accessing data at addresses mis-aligned in the internal RAM
- DMA transfer for the internal RAM

4.2.10 Watchdog timer during break

When both the following conditions (a) and (b) are satisfied and a break occurs, the watchdog timer does not stop and a reset or a non-maskable interrupt occurs. If a reset occurs, the debugger hangs up.

- (a) The main clock or subclock is selected as the source clock for the watchdog timer
- (b) The internal oscillator is stopped (RSTOP flag =1)

[Workaround]

Implement (a) or (b) below.

- (a) Use the internal oscillation clock as the source clock.
- (b) Do not stop internal oscillator.

4.2.11 16-bit timer M during break

When a break occurs while the following both (a) and (b) are satisfied, timer M does not stop even if the Peripheral Break function has been set to "Break".

- (a) INTWT, internal oscillation clock ($f_{R/8}$), or subclock is selected as the source clock of timer M.
- (b) The main clock is stopped by setting the MCK flag.

[Workaround]

Implement (a) or (b) below to stop timer M during a break using the Peripheral Break function.

- (a) Use the main clock (f_{xx} , $f_{xx}/2$, $f_{xx}/4$, $f_{xx}/64$, or $f_{xx}/512$) as the source clock.
- (b) Do not stop main clock oscillation.

4.2.12 Accessing UAnRX register during break

An overrun error occurs under the following conditions (a) to (c).

- (a) If a break occurs after reading the UART receive buffer register (UAnRX) and the UAnRX register is displayed in the I/O register window of the debugger, an overrun error occurs when UART reception is performed next time.
- (b) If a software break occurs immediately after reading the UART receive buffer register (UAnRX), an overrun error occurs when UART reception is performed next time regardless of whether or not the UAnRX register is displayed in the I/O register window.
- (c) If a DMA transfer from the UART receive buffer register (UAnRX) is performed during a break^{Note}, an overrun error occurs when UART reception is performed next time.

Note Including breaks by the RAM monitor function or DMM function. However, the real-time RAM monitor function does not cause this matter because it does not set breaks.

Remark An overrun error also occurs when UART receives data multiple times during a break. This is an emulator specification.

[Workaround]

- (a) Do not display the UAnRX register in the I/O register window.
- (b) Set a hardware break when setting a break immediately after reading the UAnRX register.

- (c) There is no workaround.

4.2.13 Accessing DR register during break

An overrun error occurs under the following conditions (a) and (b).

- (a) If a software break occurs immediately after reading the IEBus data register (DR), an overrun error occurs when IEBus reception is performed next time regardless of whether or not the UAnRX register is displayed in the I/O register window.
- (b) If a DMA transfer from the IEBus data register (DR) is performed during a break^{Note}, an overrun error occurs when IEBus reception is performed next time.

Note Including breaks by the RAM monitor function or DMM function. However, the real-time RAM monitor function does not cause this matter because it does not set breaks.

Remark An overrun error also occurs when UART receives data multiple times during a break. This is an emulator specification.

[Workaround]

- (a) Set a hardware break when setting a break immediately after reading the DR register.
- (b) There is no workaround.

4.2.14 Accessing CBnRX register during break

When the CSIBn receive data register (CBnRX) is read, it usually starts the next reception operation. Under the following conditions (a) and (b), however, the next reception operation is not started even if CBnRX is read.

- (a) If a software break occurs immediately after reading the CSIBn receive data register (CBnRX).
- (b) If a DMA transfer from the CSIBn receive data register (CBnRX) is performed during a break^{Note}.

As a result, communication stops or the DMA controller stops.

Note Including breaks by the RAM monitor function or DMM function. However, the real-time RAM monitor function does not cause this matter because it does not set breaks.

[Workaround]

- (a) Set a hardware break when setting a break immediately after reading the CBnRX register.
- (b) There is no workaround.

4.2.15 Accessing CnRGPT register during break

Under the following conditions (a) and (b), the read pointer (RGPT) that should be incremented is not incremented, and the same data as previously read is read.

- (a) If a software break occurs immediately after reading the CAN0 module receive history list register (CnRGPT).

- (b) If a DMA transfer from the CAN0 module receive history list register (C0RGPT) is performed during a break^{Note}.

Note Including breaks by the RAM monitor function or DMM function. However, the real-time RAM monitor function does not cause this matter because it does not set breaks.

[Workaround]

- (a) Set a hardware break when setting a break immediately after reading the C0RGPT register.
- (b) There is no workaround.

4.2.16 Accessing C0TGPT register during break

Under the following conditions (a) and (b), the read pointer (TGPT) that should be incremented is not incremented, and the same data as previously transmitted is transmitted.

- (a) If a software break occurs immediately after reading the CAN0 module transmit history list register (C0TGPT).
- (b) If a DMA transfer from the CAN0 module transmit history list register (C0TGPT) is performed during a break^{Note}.

Note Including breaks by the RAM monitor function or DMM function. However, the real-time RAM monitor function does not cause this matter because it does not set breaks.

[Workaround]

- (a) Set a hardware break when setting a break immediately after reading the C0TGPT register.
- (b) There is no workaround.

4.2.17 Accessing CnGNCTRL register during break

When a register access is performed in the following sequence, a forcible shutdown that should not take place normally may occur after the sequence is complete.

[Sequence]

- (1) The EFSD bit of the CAN0 module control register (C0GMCTRL) is set.
- (2) The I/O register^{Note} is accessed.
- (3) The GOM bit of the CAN0 module control register (C0GMCTRL) is cleared.

Note I/O register access except for clearing the GOM bit of the C0GMCTRL register

Conditions under which a forcible shutdown takes place are shown below.

- (a) If a break occurs immediately after the I/O register access in (2) occurs
- (b) If a break by the RAM monitor function or DMM function occurs immediately after the I/O register access in (2) occurs
- (c) Stepwise execution is performed for the I/O register access in (2)

[Workaround]

Be sure to set the EFSD bit and clear the GOM bit successively when executing a forcible shutdown.

Do not perform register access in the above sequence when not performing a forcible shutdown.

4.2.18 Entering and releasing STOP mode when RESET pin is masked

When the RESET pin is masked using the pin mask function of the debugger and watchdog timer 2 is used in reset mode, the CPU's operating clock is switched to the internal oscillation clock after STOP mode is released, depending on the timing for entering and releasing STOP mode (one of (1) to (4) in the following table). After the clock is switched to the internal oscillation clock, the CPU continues the operation with the internal oscillation clock until the CPU reset button on the debugger is pressed.

No.	Operating Clock for Watchdog Timer 2	Timing at Which This matter occurs
(1)	Main clock	STOP mode is entered during the period from when a reset of watchdog timer 2 occurs until the reset is released ^{Note}
(2)	Subclock	STOP mode is entered during the period from when a reset of watchdog timer 2 occurs until the reset is released ^{Note}
(3)	Internal oscillation clock	STOP mode is entered during the period from when a reset of watchdog timer 2 occurs until the reset is released ^{Note}
(4)		The internal oscillation clock is stopped during the period from when a reset of watchdog timer 2 occurs until the reset is released ^{Note} , and then STOP mode is entered

Note The reset signal for watchdog timer 2 is held for the period " $2^7 \times$ watchdog timer input clock" after a reset of watchdog timer 2 occurs.

[Workaround]

Implement either of the following workarounds.

- To prevent a reset of watchdog timer 2 from occurring, stop watchdog timer 2 by using software before the reset occurs.
- To generate a reset of watchdog timer 2, do not mask the RESET pin using the pin mask function of the debugger.

4.2.19 A/D conversion function during a break

(1) A/D conversion does not start if any one of the following conditions <a> to <c> is satisfied in peripheral break mode (mode in which peripheral functions are stopped during a break). In addition, no interrupt requests are generated upon completion of the A/D conversion.

<a> A break occurs from when an A/D conversion start trigger is generated^{Note 1} until the execution of two instructions ends^{Note 2}.

Example: In software trigger mode

```
* set1 0x7, ADA0M0 }
* nop                } A/D conversion does not start if a break occurs
* nop                } during this period.
* nop                }
* nop                } If a break occurs after this point, A/D conversion starts normally.
                    } (Caution must still be exercised for the matters described in (2)
                    } and (3).)
```

 If execution is started using an A/D conversion start instruction in software trigger mode, and a software break or a break before execution is set to the instruction.

Example:

B set1 0x7, ADA0M0 ← A/D conversion does not start if an attempt is made to start A/D conversion using the instruction in this

<c> A break occurs while an A/D conversion operation is stopped, and an attempt is made to start A/D conversion during this break^{Note 3}.

(2) If a break occurs^{Note 2} during A/D conversion in peripheral break mode, a write is performed^{Note 5} on an A/D-related register^{Note 4}, and the A/D conversion is re-executed, then conversion is performed once or twice with the values before the writing. (If the break occurs in normal conversion operation mode, A/D conversion may be performed twice with the values before the writing.) After this conversion is completed, A/D conversion starts with the values after the writing. Consequently, an invalid A/D conversion result is obtained and it seems as though invalid interrupts occur once or twice for the operation. (Normally, re-conversion is performed immediately after re-execution with values newly set to the A/D-related register.)

(3) If a break occurs during A/D conversion in peripheral break mode, the A/D conversion result immediately after re-execution is invalid. Moreover, if a break occurs during A/D conversion in high-speed conversion mode, and the ADA0CE bit is cleared and re-set during the break, then the result of the subsequent one A/D conversion operation is invalid.

Notes 1. Starting conversion by DMA transfer, external trigger, and timer trigger are included in this condition, in addition to starting conversion triggered by instruction execution.

2. Includes the following break sources.

- Step execution
- Fail-safe break
- RAM monitoring (real-time RAM monitoring does not apply)
- DMM
- Change of event while the program is running

Among these sources, RAM monitoring, DMM, and a change of event while the program is running is implemented through an instantaneous break, so the actual break point cannot be specified, and thus the A/D conversion unexpectedly becomes invalid.

3. DMA transfer, external trigger, and timer trigger are included in this condition, in addition to a write access to the ADA0CE bit in the IO register window.

4. A/D-related registers: ADA0M0, ADA0M1, ADA0M2, ADA0S, ADA0PFT, and ADA0PFM

5. Cases such that the write setting is applied in the IO register window, or through DMA transfer.

[Workaround]

Do not set peripheral break mode if you want to avoid this matter entirely, or observe all of the

following.

- Do not set breaks between the A/D conversion start trigger and the end of A/D conversion.
- Do not perform step execution of an A/D conversion start instruction in software trigger mode.
- Do not perform write accesses to A/D-related registers during a break.
- Disable the RAM monitoring function.
- Do not use DMM.
- Do not change events while the program is running.

4.2.20 Notes on Fail Safe Break

The following fail safe break does not occur

- Read access to area from 0x18_0000 to 0x1F_FFFF
- Read/Write access to area from 0x3E0_0000 to 3FE_3FFFH

And when write access to area from 0x10_0000 to 0x17_FFFF occurs, the fail safe break occurs, but the data may be changed. So then it is need to download the load module.

CHAPTER 5 OPTIONAL FUNCTIONS

The following functions can be added to the QB-V850ESX3H. This chapter explains the functional outline and specifications of the optional functions, and how to obtain them.

- Coverage measurement function
- TimeMachine™ function

5.1 Coverage Measurement Function

This section explains the functional outline of the coverage measurement function and differences in specifications that occur after the addition of this function.

5.1.1 Functional outline

The coverage measurement function is used to measure the percentage of the executed code in a load module, section, or other such area. After the addition of this function, the Code Coverage window will be added and the Source and Assemble windows will be modified in the debugger ID850QB, as follows.

- Code Coverage window

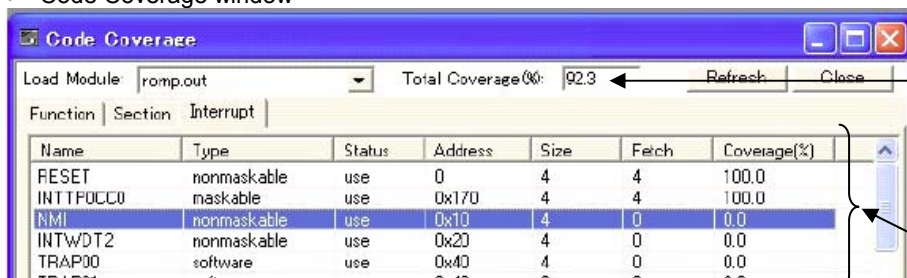

Displays the coverage (%) of the executed code for total code in a load module.

Displays the coverage (%) of the executed code separately by functions, sections and vectors.

- Source window and Assemble window

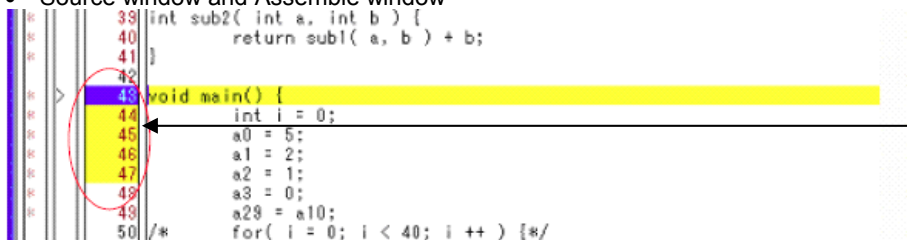

The executed lines are highlighted.

Refer to the user's manual for the debugger for details on use of the coverage measurement function.

5.2.2 Differences from hardware specifications

After addition of the coverage measurement function, differences from the hardware specifications described in this manual are as follows.

- External dimensions
The height increases by 9 mm.

Note When the rear spacer is adjusted to the lowest height (107 mm max.)

- Weight
The weight increases by approximately 70 g.

5.3 TimeMachine Function

This function is supported by the Green Hills Software (GHS) debugger. For details on the functional outline and specifications, consult a GHS tool distributor.

5.4 Changes to Top Side of Product Consequent to Addition of Optional Functions

After the addition of the optional functions, the following stickers will be attached to the top of the QB-V850ESX3H. The addition of the optional functions can be confirmed through the presence of these stickers.

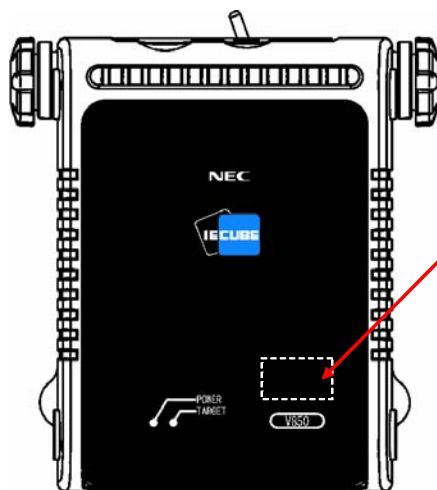

QB-V850ESX3H Top

A sticker is attached to this position according to the function added, as follows.

For the coverage measuring function:



For the TimeMachine function:

