

# QMot QBL4208 family



## Manual

V1.04  
2019-JAN-14



# TRINAMIC

MOTION CONTROL

Trinamic Motion Control GmbH & Co. KG  
Waterloohain 5  
D – 22769 Hamburg, Germany  
<http://www.trinamic.com>

## Table of Contents

1	Life support policy.....	3
2	Features .....	4
3	Order codes.....	5
4	Mechanical dimensions.....	6
4.1	Dimensions .....	6
4.2	Leadwire configuration .....	6
5	Torque figures.....	7
5.1	Motor QBL4208-41-04-006 .....	7
5.2	Motor QBL4208-61-04-013 .....	8
5.3	Motor QBL4208-81-04-019 .....	9
5.4	Motor QBL4208-100-04-025 .....	10
6	Motor sizing .....	12
6.1	Peak torque requirement.....	12
6.2	RMS torque requirement .....	12
6.3	Motor velocity .....	13
7	Revision history.....	14
7.1	Document revision .....	14

## List of Figures

Figure 4.1:	Dimensions (all values in mm).....	6
Figure 5.1:	QBL4208-41-04-006 velocity vs. torque characteristics.....	7
Figure 5.2:	QBL4208-61-04-013 velocity vs. torque characteristics.....	8
Figure 5.3:	QBL4208-81-04-019 velocity vs. torque characteristics.....	9
Figure 5.4:	QBL4208-100-04-025 velocity vs. torque characteristics.....	10
Figure 5.5:	QBL4208-100-04-025 torque vs. current characteristics .....	11
Figure 6.1:	Trapezoidal move and triangular move .....	13

## List of Tables

Table 2.1:	Motor technical data .....	4
Table 3.1:	Order codes .....	5
Table 4.1:	Leadwire configuration.....	6
Table 7.1:	Document revision .....	14

---

# 1 Life support policy

TRINAMIC Motion Control GmbH & Co. KG does not authorize or warrant any of its products for use in life support systems, without the specific written consent of TRINAMIC Motion Control GmbH & Co. KG.

Life support systems are equipment intended to support or sustain life, and whose failure to perform, when properly used in accordance with instructions provided, can be reasonably expected to result in personal injury or death.

© TRINAMIC Motion Control GmbH & Co. KG 2010-2019

Information given in this data sheet is believed to be accurate and reliable. However neither responsibility is assumed for the consequences of its use nor for any infringement of patents or other rights of third parties, which may result from its use.

Specifications are subject to change without notice.

## 2 Features

QMOT BLDC motors are quality motors for universal use. They feature a long life due to ball bearings and no wearing out parts. These BLDC motors give a good fit to the TRINAMIC family of medium and high current BLDC motor modules.

### Main characteristics:

- Hall Effect Angle: 120° electric angle
- Shaft run out: 0,025 mm
- Insulation Class: B
- Radial Play: 0,02 mm 450G load
- Max Radial Force: 28N (10mm from flange)
- Max Axial Force: 10N
- Dielectric Strength: 500 VDC For One Minute
- Insulation Resistance: 100M Ohm min. 500VDC
- Recommended Ambient Temp.: -20 to +40°C
- Bearing: Brushless motors fitted with ball bearings
- Coil windings in delta topology

Specifications		QBL 4208			
		-41-04-006	-61-04-013	-81-04-019	-100-04-025
No. of Pole		8	8	8	8
No. of Phase		3	3	3	3
Rated Voltage	V	24	24	24	24
Rated Phase Current	A	1.79	3.47	5.14	6.95
Rated Speed	RPM	4000	4000	4000	4000
Rated Torque	Nm	0.0625	0.125	0.185	0.25
Max Peak Torque	Nm	0.19	0.38	0.56	0.75
Torque Constant	Nm/A	0.035	0.036	0.036	0.036
Line to Line Resistance	Ohm	1.8	0.72	0.55	0.28
Line to Line Inductance	mH	2.6	1.2	0.8	0.54
Max Peak Current	A	5.4	10.6	15.5	20
Length (L <sub>MAX</sub> )	mm	41	61	81	100
Rotor Inertia	kgm <sup>2</sup> x 10 <sup>-6</sup>	24	48	72	96
Mass	kg	0.3	0.45	0.65	0.8

**Table 2.1: Motor technical data**

## 3 Order codes

Order code	Description	Dimensions (mm)
QBL4208-41-04-006	QMot BLDC motor 42 mm, 4000RPM, 0.06Nm	42 x 42 x 41
QBL4208-61-04-013	QMot BLDC motor 42 mm, 4000RPM, 0.13Nm	42 x 42 x 61
QBL4208-81-04-019	QMot BLDC motor 42 mm, 4000RPM, 0.19Nm	42 x 42 x 81
QBL4208-100-04-025	QMot BLDC motor 42 mm, 4000RPM, 0.25Nm	42 x 42 x 100

**Table 3.1: Order codes**

## 4 Mechanical dimensions

### 4.1 Dimensions

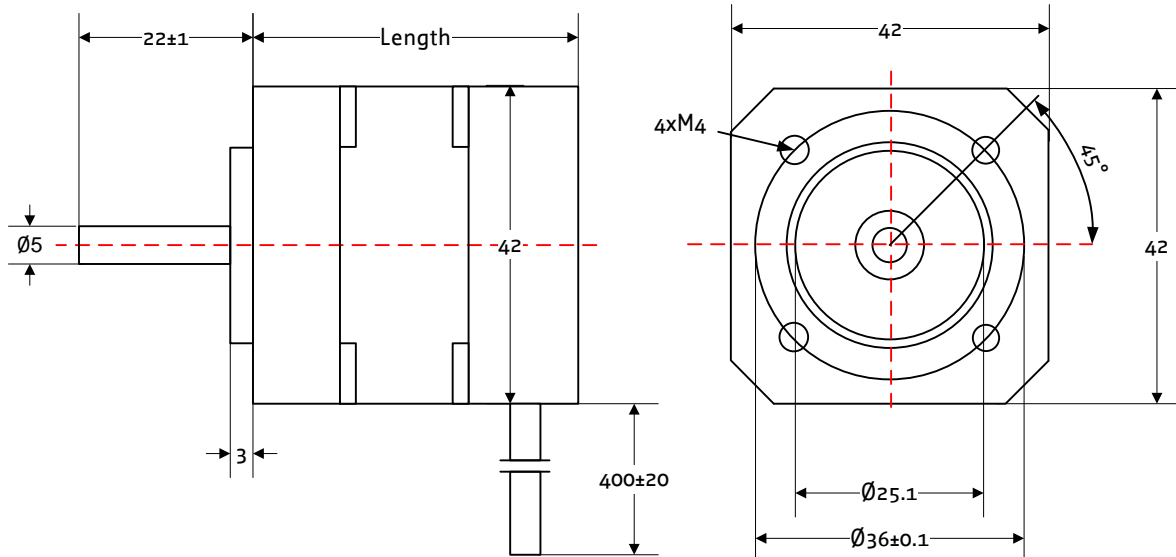

Figure 4.1: Dimensions (all values in mm)

### 4.2 Leadwire configuration

Cable type 1		Gauge	Function
Red	■	UL1007 AWG26	Vcc Hall Sensor +5VDC to +24VDC
Blue	■	UL1007 AWG26	Hall A
Green	■	UL1007 AWG26	Hall B
White	□	UL1007 AWG26	Hall C
Black	■	UL1007 AWG26	GND Hall Sensor Ground
Yellow	■	UL1007 AWG20	Phase U
Red	■	UL1007 AWG20	Phase V
Black	■	UL1007 AWG20	Phase W

Table 4.1: Leadwire configuration

## 5 Torque figures

The torque figures detail motor torque characteristics measured in block commutation. Please be careful not to operate the motors outside the blue field. This is possible for short times only because of a resulting high coil temperature. The motors have insulation class B.

The blue field is described by rated speed and rated torque.

### 5.1 Motor QBL4208-41-04-006

Velocity vs. torque measured with 24V supply voltage

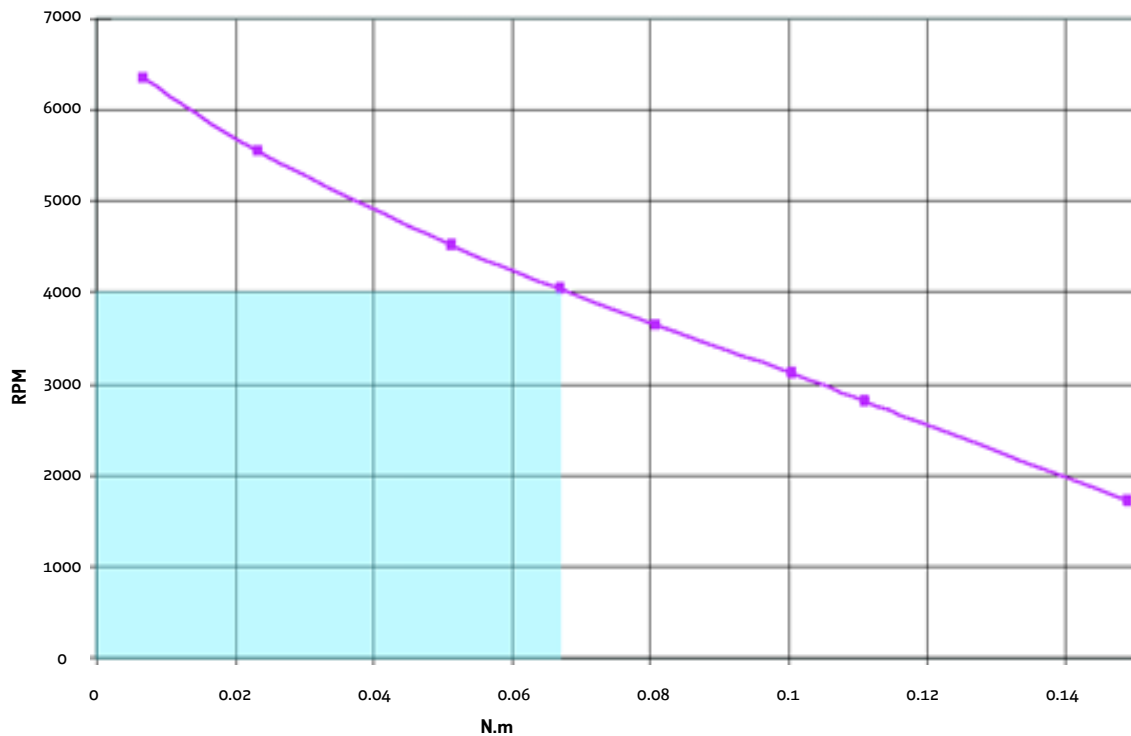

Figure 5.1: QBL4208-41-04-006 velocity vs. torque characteristics

## 5.2 Motor QBL4208-61-04-013

Velocity vs. torque measured with 24V supply voltage

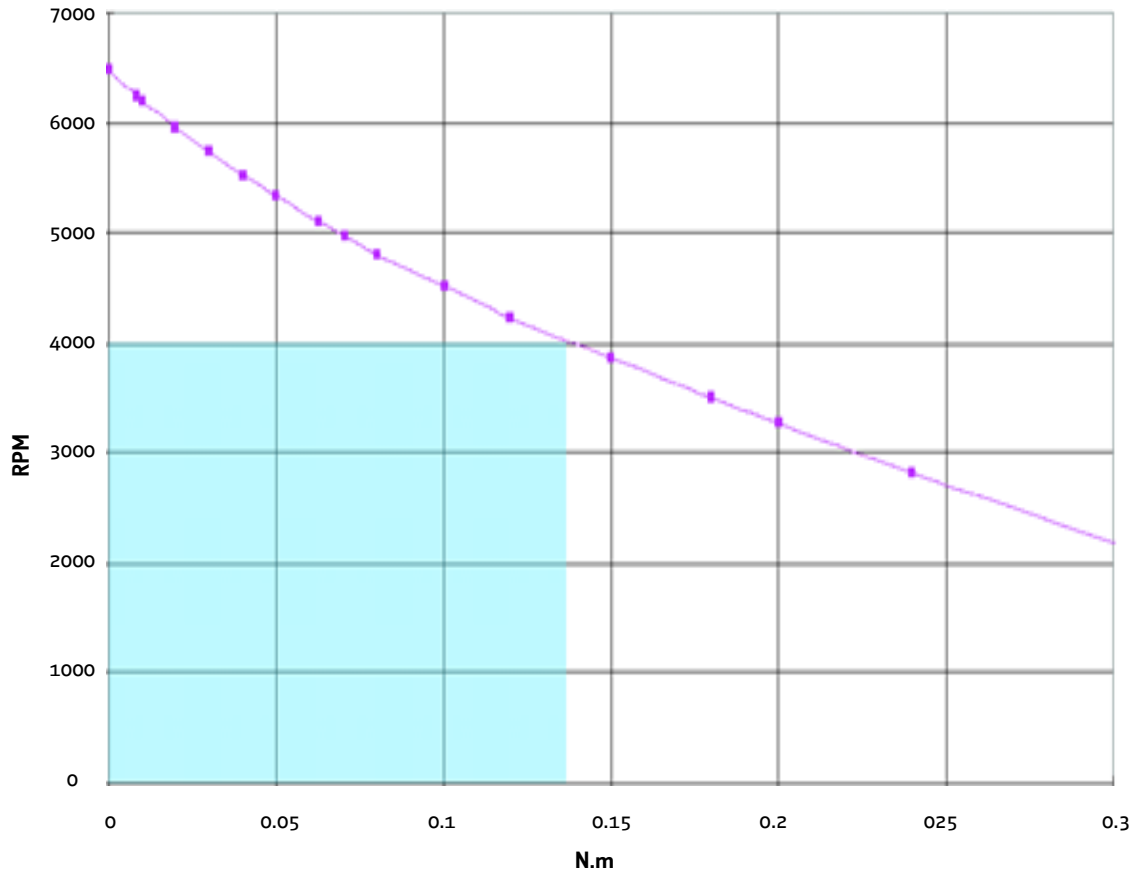

Figure 5.2: QBL4208-61-04-013 velocity vs. torque characteristics



### 5.3 Motor QBL4208-81-04-019

Velocity vs. torque measured with 24V supply voltage

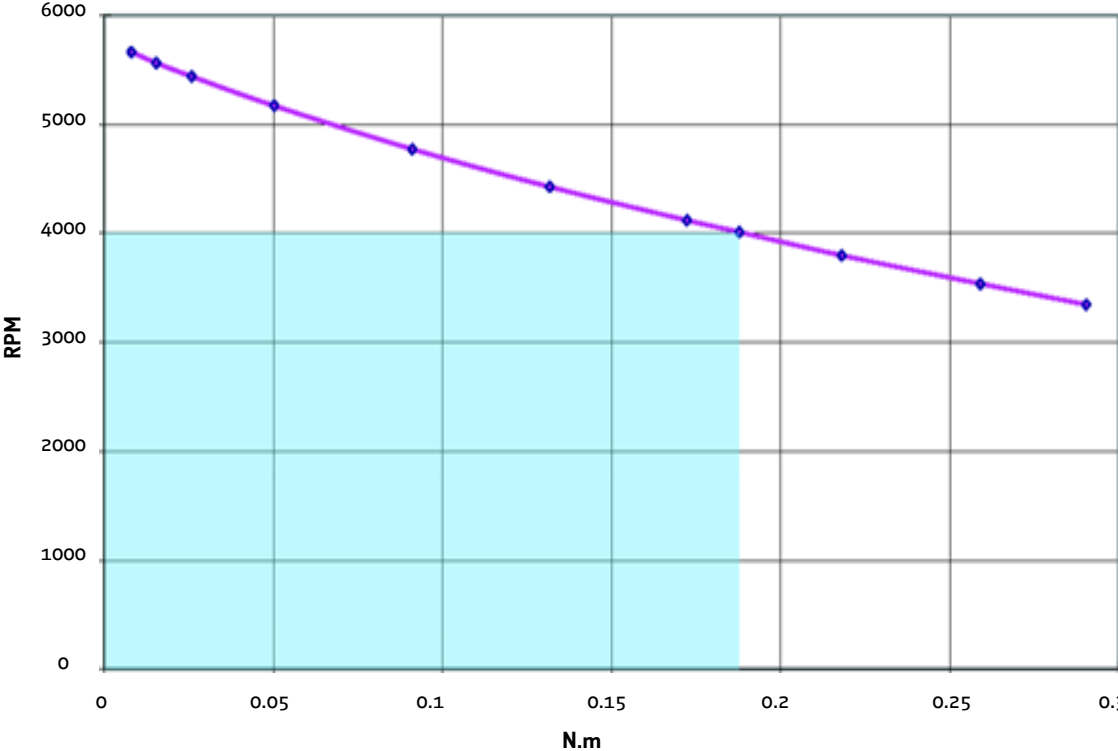

Figure 5.3: QBL4208-81-04-019 velocity vs. torque characteristics

### 5.4 Motor QBL4208-100-04-025

Velocity vs. torque measured with 24V supply voltage

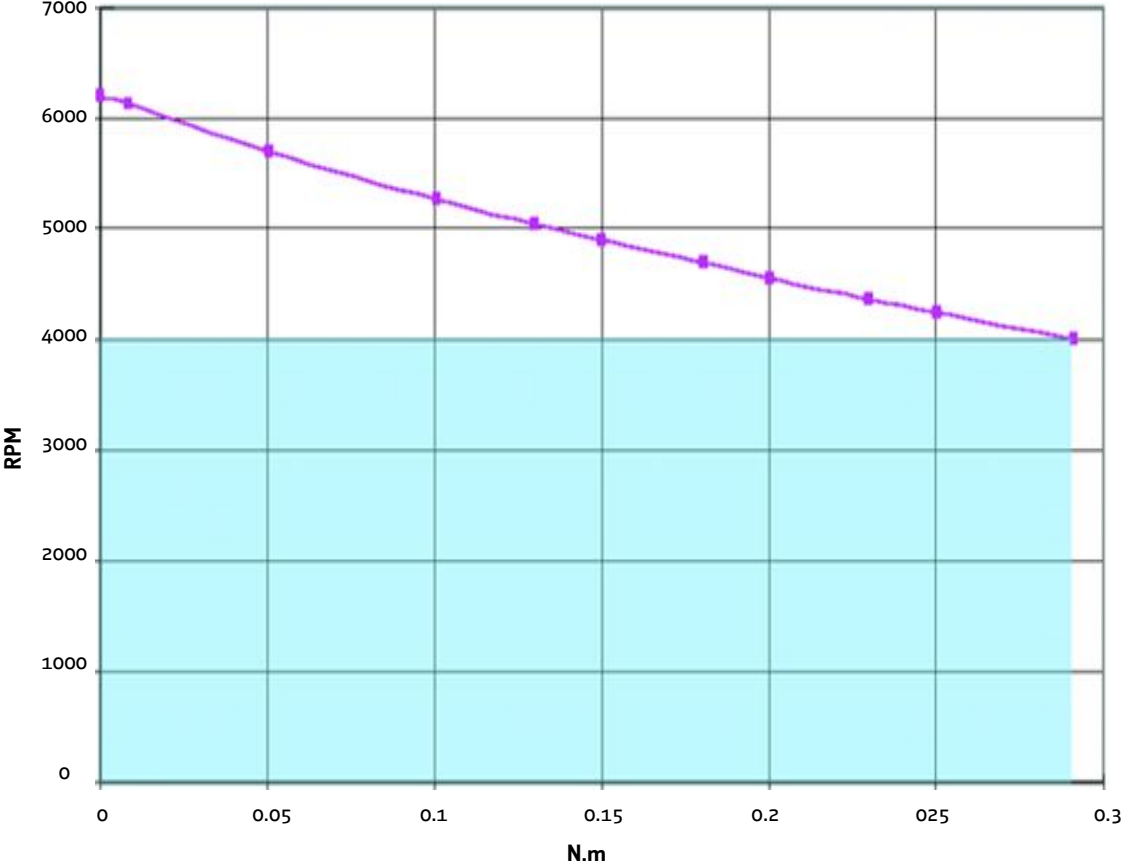

Figure 5.4: QBL4208-100-04-025 velocity vs. torque characteristics

Torque vs. current measured with 24V supply voltage

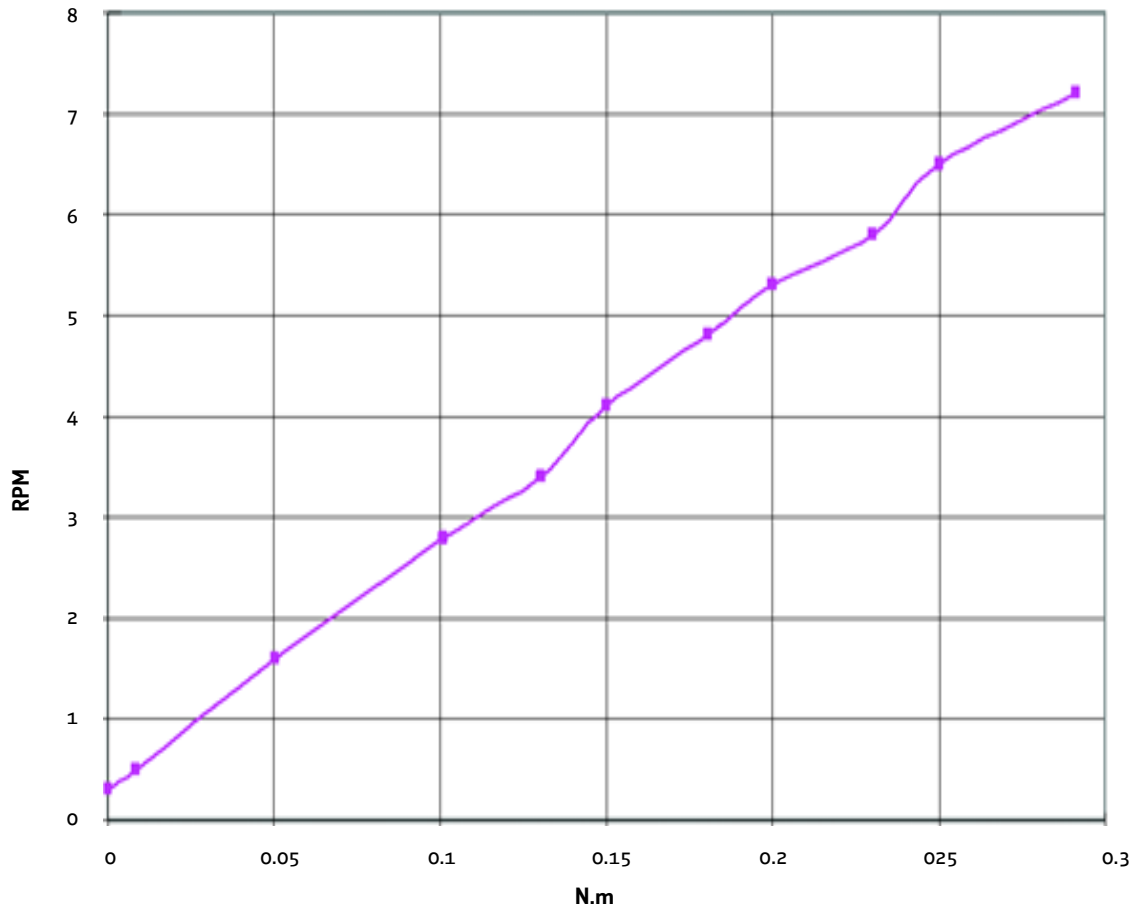

Figure 5.5: QBL4208-100-04-025 torque vs. current characteristics

## 6 Motor sizing

For the optimum solution it is important to fit the motor to the application. The three key parameters are peak torque requirement, RMS torque requirement and motor velocity.

### 6.1 Peak torque requirement

Peak torque  $T_P$  is the sum of the torque due to acceleration of inertia ( $T_J$ ), load ( $T_L$ ) and friction ( $T_F$ ):

$$T_P = T_J + T_L + T_F$$

The torque due to inertia is the product of the load (including motor rotor) inertia and the load acceleration:

$$T_J = J \cdot a$$

The torque due to the load is defined by the configuration of the mechanical system coupled to the motor. The system also determines the amount of torque required to overcome the friction.

### 6.2 RMS torque requirement

Root-Mean-Square or RMS torque is a value used to approximate the average continuous torque requirement. Its statistical approximation is with

t1: acceleration time    t2: run time    t3: deceleration time    t4: time in a move

$$T_{RMS} = \sqrt{\frac{T_P^2 \cdot t_1 + (T_L + T_F)^2 \cdot t_2 + (T_J - T_L - T_F)^2 \cdot t_3}{t_1 + t_2 + t_3 + t_4}}$$

### 6.3 Motor velocity

The motor velocity is also dictated by the configuration of the mechanical system that is coupled to the motor shaft, and by the type of move that is to be affected. For example, a single velocity application would require a motor with rated velocity equal to the average move velocity. A point to point positioning would require a motor with a rated velocity higher than the average move velocity. (The higher velocity would account for acceleration, deceleration and run times of the motion profile). Figure 6.1: Trapezoidal move and triangular move relates rated motor velocity to average move velocity for two point to point positioning move profiles.

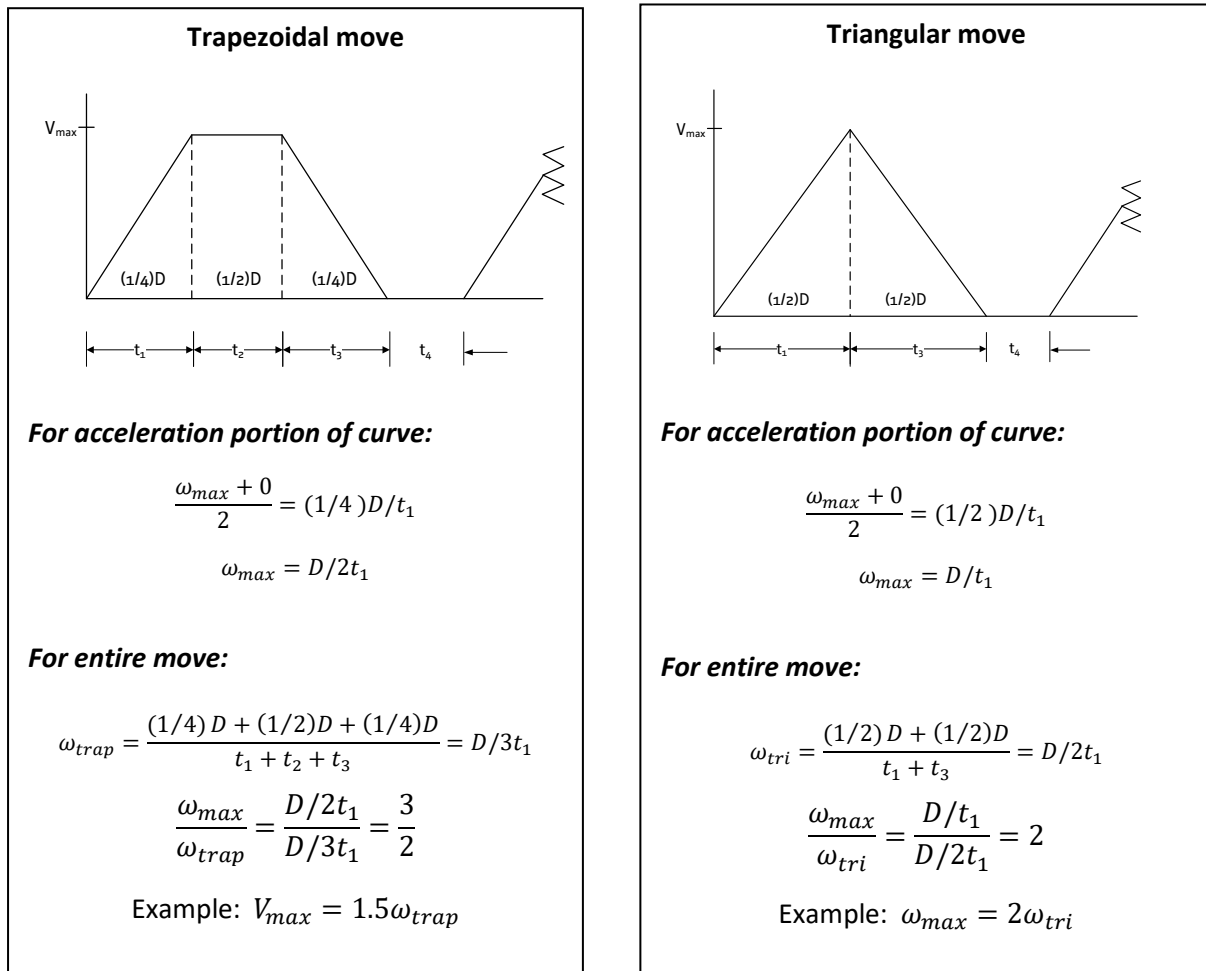

$\omega_{max}$	rated operating speed of motor RPM
$\omega_{trap}$	average speed of motor required for a specified trapezoidal move, RPM
$\omega_{tri}$	average speed of motor required for a specified triangular move, RPM
D	total distance traveled, motor shaft revolutions
$t_1$	acceleration time, seconds
$t_2$	run time, seconds
$t_3$	deceleration time, seconds
$t_4$	dwel time, seconds

Figure 6.1: Trapezoidal move and triangular move