

# LJxx04xx & QJxx04xx Series

## 4 Amp High Temperature Sensitive & Standard Triacs

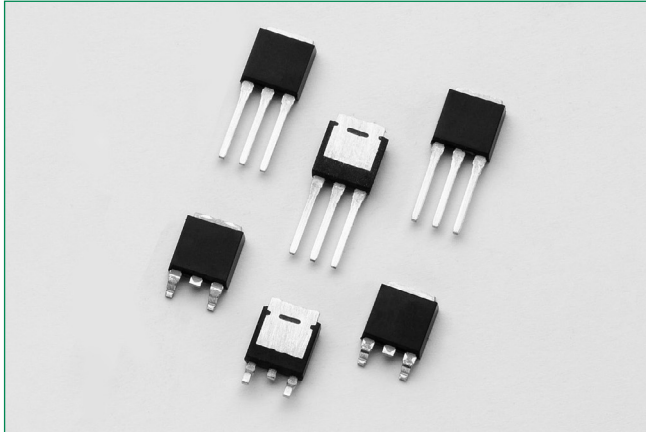

### Additional Information



Resources



Accessories



Samples

### Main Features

Symbol	Value	Unit
$I_{T(RMS)}$	4	A
$V_{DRM}/V_{RRM}$	400 or 600	V
$I_{GT(Q1)}$	10 to 25	mA

### Description

This 4 A High Temperature Triac solid state switch series is designed for AC switching and phase control applications such as motor speed and temperature modulation controls, lighting controls, and static switching relays.

**Sensitive** type components guarantee gate control in Quadrants I & IV needed for digital control circuitry.

**Standard** type components normally operate in Quadrants I & III triggered from AC line.

### Features & Benefits

- 150°C maximum junction temperature
- Voltage capability up to 600V
- Surge capability up to 48A at 60HZ half cycle
- Solid-state switching eliminates arcing or contact bounce that create voltage transients
- No contacts to wear out from reaction of switching events
- Restricted (or limited) RFI generation, depending on activation point of sine wave
- Requires only a short gate activation pulse in each half-cycle
- Halogen free and RoHS compliant

### Applications

Typical applications are AC solid-state switches, power tools, home/brown goods and white goods appliances.

Sensitive gate Triacs can be directly driven by microprocessor or popular opto-couplers/isolators.

Internally constructed isolated packages are offered for ease of heat sinking with highest isolation voltage.

### Schematic Symbol

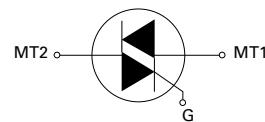

### Absolute Maximum Ratings – Sensitive Triacs (4 Quadrants)

Symbol	Parameter	Value	Unit
$V_{DSM}/V_{RSM}$	Peak non-repetitive blocking voltage	PW=100 $\mu$ s	700 V
$I_{T(RMS)}$	RMS on-state current (full sine wave)	LJxx04Vy/LJxx04Dy $T_c = 135^\circ\text{C}$	4 A
$I_{TSM}$	Non repetitive surge peak on-state current (full cycle, $T_j$ initial = 25°C)	f = 50 Hz t = 20 ms	40 A
		f = 60 Hz t = 16.7 ms	48 A
$I^2t$	$I^2t$ Value for fusing	$t_p = 8.3$ ms	9.5 A <sup>2</sup> s
di/dt	Critical rate of rise of on-state current ( $I_G = 50$ mA with $\leq 0.1$ $\mu$ s rise time)	f = 60 Hz $T_j = 150^\circ\text{C}$	50 A/ $\mu$ s
$I_{GTM}$	Peak gate trigger current	$t_p = 20$ $\mu$ s $T_j = 150^\circ\text{C}$	4 A
$P_{G(AV)}$	Average gate power dissipation	$T_j = 150^\circ\text{C}$	0.3 W
$T_{stg}$	Storage temperature range		-40 to 150 °C
$T_j$	Operating junction temperature range		-40 to 150 °C

Note: xx=voltage/10, y = sensitivity

# LJxx04xx & QJxx04xx Series

## 4 Amp High Temperature Sensitive & Standard Triacs

### Absolute Maximum Ratings – Standard Triacs

Symbol	Parameter	Value	Unit
$V_{DSM}/N_{RSM}$	Peak non-repetitive blocking voltage	PW=100 $\mu$ s	700 V
$I_{T(RMS)}$	RMS on-state current (full sine wave)	QJxx04Vy/QJxx04Dy $T_C = 135^\circ\text{C}$	4 A
$I_{TSM}$	Non repetitive surge peak on-state current (full cycle, $T_J$ initial = $25^\circ\text{C}$ )	f = 50 Hz t = 20 ms	40 A
		f = 60 Hz t = 16.7 ms	48 A
$I^2t$	$I^2t$ Value for fusing	$t_p = 8.3$ ms	9.5 A <sup>2</sup> s
di/dt	Critical rate of rise of on-state current ( $I_G = 50\text{mA}$ with $\leq 0.1\mu\text{s}$ rise time)	f = 60 Hz $T_J = 150^\circ\text{C}$	50 A/ $\mu$ s
$I_{GTM}$	Peak gate trigger current	$t_p = 20\mu\text{s}$ $T_J = 150^\circ\text{C}$	4 A
$P_{G(AV)}$	Average gate power dissipation	$T_J = 150^\circ\text{C}$	0.3 W
$T_{stg}$	Storage temperature range		-40 to 150 $^\circ\text{C}$
$T_J$	Operating junction temperature range		-40 to 150 $^\circ\text{C}$

Note: xx=voltage/10,  $\gamma$  = sensitivity

### Electrical Characteristics ( $T_J = 25^\circ\text{C}$ , unless otherwise specified) – Sensitive Triac (4 Quadrants)

Symbol	Test Conditions	Quadrant	LJxx04x8	Unit
$I_{GT}$	$V_D = 12\text{V}$ $R_L = 60\ \Omega$	I – II – III	10	mA
		IV	20	
$V_{GT}$	$V_D = 12\text{V}$ $R_L = 60\ \Omega$	ALL	MAX.	1.3 V
$V_{GD}$	$V_D = V_{DRM}$ $R_L = 3.3\ \text{k}\Omega$ $T_J = 150^\circ\text{C}$	ALL	MIN.	0.2 V
$I_H$	$I_T = 100\text{mA}$		MAX.	20 mA
dv/dt	$V_D = V_{DRM}$ Gate Open $T_J = 150^\circ\text{C}$	400V	TYP.	75 V/ $\mu$ s
		600V		45 V/ $\mu$ s
(dv/dt)c	(di/dt)c = 2.16 A/ms $T_J = 150^\circ\text{C}$		TYP.	1 V/ $\mu$ s
$t_{gt}$	$I_G = 2 \times I_{GT}$ PW = 15 $\mu$ s $I_T = 5.6$ A(pk)		TYP.	10 $\mu$ s

Note: xx=voltage/10, x = package

### Electrical Characteristics ( $T_J = 25^\circ\text{C}$ , unless otherwise specified) – Standard Triac

Symbol	Test Conditions	Quadrant	QJxx04x3	QJxx04x4	Unit
$I_{GT}$	$V_D = 12\text{V}$ $R_L = 60\ \Omega$	I – II – III	MAX.	10	mA
		IV	TYP.	25	
$V_{GT}$	$V_D = 12\text{V}$ $R_L = 60\ \Omega$	I – II – III	MAX.	1.3	V
$V_{GD}$	$V_D = V_{DRM}$ $R_L = 3.3\ \text{k}\Omega$ $T_J = 150^\circ\text{C}$	ALL	MIN.	0.2	V
$I_H$	$I_T = 200\text{mA}$		MAX.	20	30 mA
dv/dt	$V_D = V_{DRM}$ Gate Open $T_J = 150^\circ\text{C}$	400V	MIN.	75	150 V/ $\mu$ s
		600V		45	100 V/ $\mu$ s
(dv/dt)c	(di/dt)c = 2.16 A/ms $T_J = 150^\circ\text{C}$		TYP.	2	V/ $\mu$ s
$t_{gt}$	$I_G = 2 \times I_{GT}$ PW = 15 $\mu$ s $I_T = 5.6$ A(pk)		TYP.	10	15 $\mu$ s

Note: xx=voltage/10, x = package

# LJxx04xx & QJxx04xx Series

## 4 Amp High Temperature Sensitive & Standard Triacs

### Static Characteristics ( $T_J = 25^\circ\text{C}$ , unless otherwise specified)

Symbol	Test Conditions		Value	Unit		
$V_{TM}$	$I_{TM} = 5.6\text{A}$ $t_p = 380\ \mu\text{s}$	MAX.	1.40	V		
$I_{DRM}$ $I_{RRM}$	$V_{DRM} = V_{RRM}$	MAX.	LJxx04xy	$T_J = 25^\circ\text{C}$	5	$\mu\text{A}$
				$T_J = 125^\circ\text{C}$	0.5	mA
			$T_J = 150^\circ\text{C}$	3		
			QJxx04xy	$T_J = 25^\circ\text{C}$	5	$\mu\text{A}$
				$T_J = 125^\circ\text{C}$	0.5	mA
				$T_J = 150^\circ\text{C}$	3	

Note: xx=voltage/10, x = package, y = sensitivity

### Thermal Resistances

Symbol	Parameter	Value	Unit
$R_{\theta(JC)}$	Junction to case (AC)	LJ/QJxx04Dy	1.5
		LJ/QJxx04Vy	1.5
$R_{\theta(JA)}$	Junction to ambient	LJ/QJxx04Vy LJ/QJxx04Dy	70

Note: xx=voltage/10, y = sensitivity

**Figure 1:**  
Definition of Quadrants

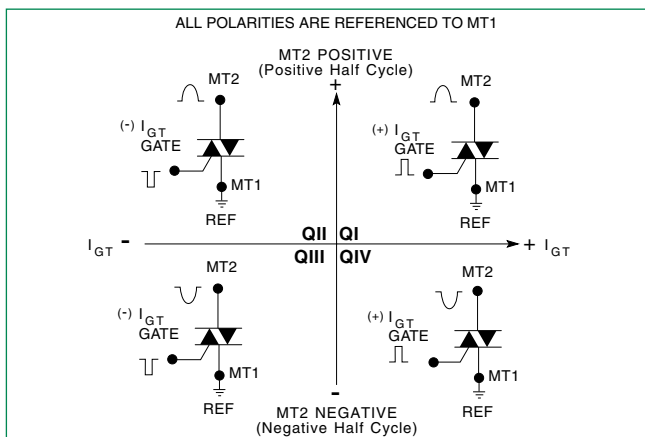

**Figure 2:**  
Normalized DC Gate Trigger Current for All Quadrants vs. Junction Temperature

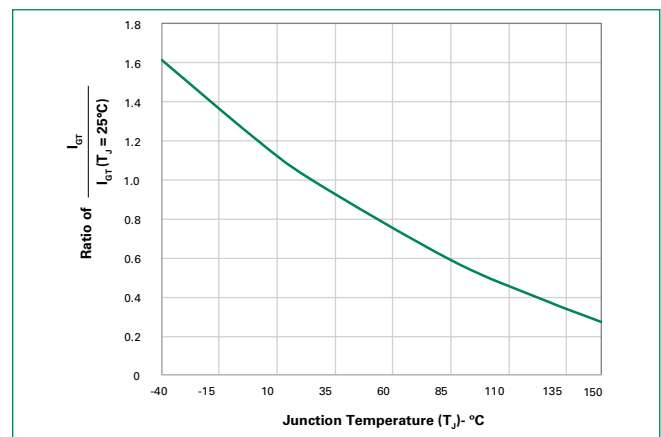

# LJxx04xx & QJxx04xx Series

## 4 Amp High Temperature Sensitive & Standard Triacs

**Figure 3:**  
Normalized DC Holding Current vs. Junction Temperature

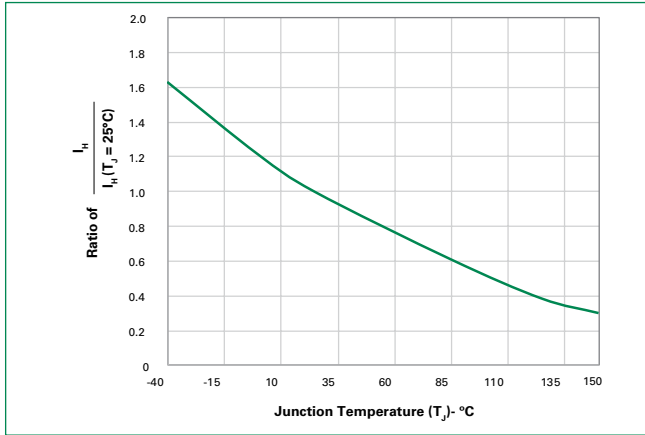

**Figure 4:**  
Normalized DC Gate Trigger Voltage for All Quadrants vs. Junction Temperature

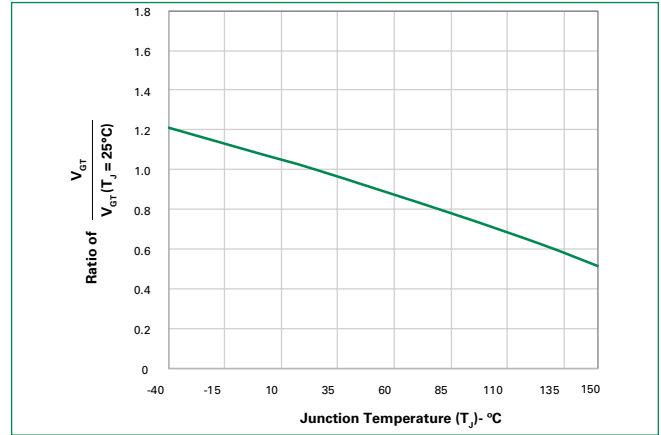

**Figure 5:**  
Power Dissipation (Typical) vs. RMS On-State Current

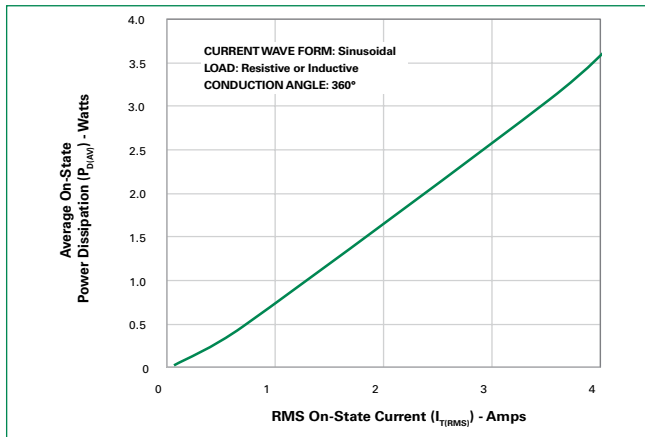

**Figure 6:**  
Maximum Allowable Case Temperature vs. On-State Current

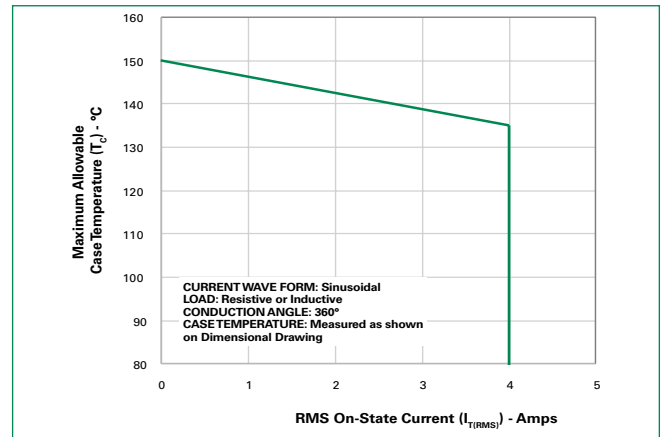

**Figure 7:**  
On-State Current vs. On-State Voltage (Typical)

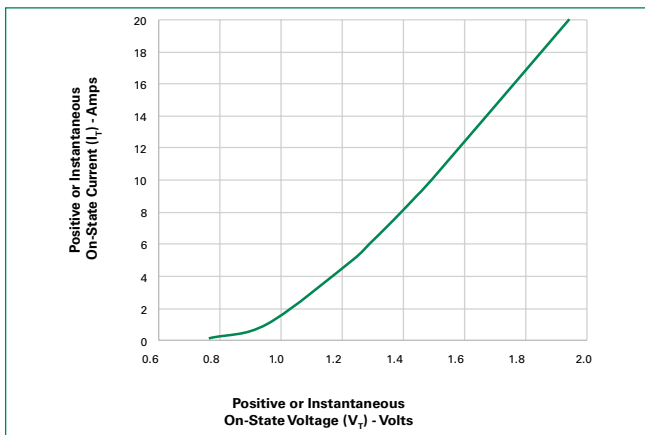

# LJxx04xx & QJxx04xx Series

## 4 Amp High Temperature Sensitive & Standard Triacs

Figure 8: Surge Peak On-State Current vs. Number of Cycles

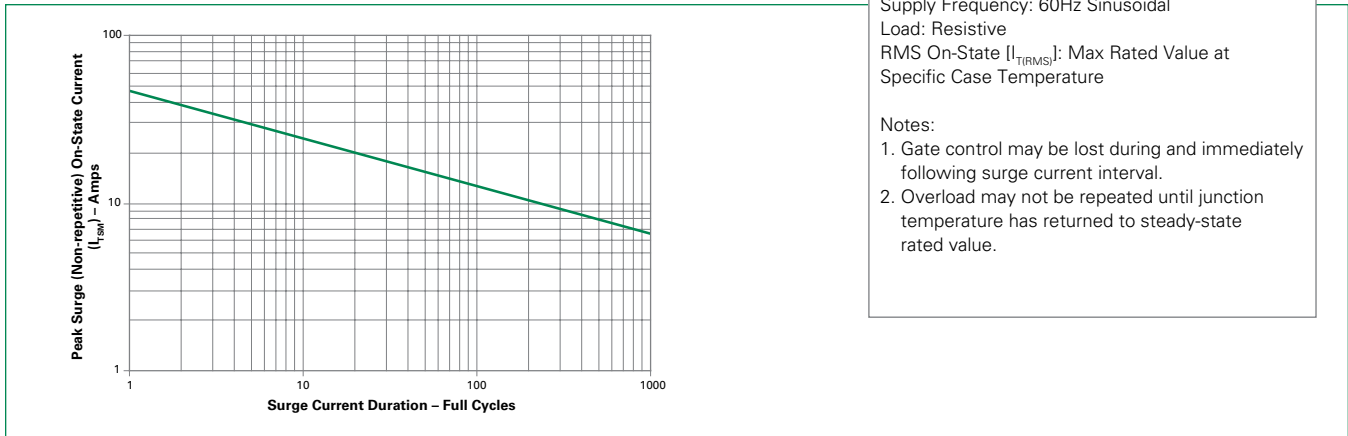

### Soldering Parameters

<b>Reflow Condition</b>	Pb – Free assembly	
<b>Pre Heat</b>	- Temperature Min ( $T_{s(min)}$ )	150°C
	- Temperature Max ( $T_{s(max)}$ )	200°C
	- Time (min to max) ( $t_s$ )	60 – 120 secs
<b>Average ramp up rate (Liquidus Temp) (<math>T_L</math>) to peak</b>	3°C/second max	
<b><math>T_{s(max)}</math> to <math>T_L</math> - Ramp-up Rate</b>	3°C/second max	
<b>Reflow</b>	- Temperature ( $T_L$ ) (Liquidus)	217°C
	- Time ( $t_r$ )	60 – 150 seconds
<b>Peak Temperature (<math>T_p</math>)</b>	260 <sup>+0/-5</sup> °C	
<b>Time within 5°C of actual peak Temperature (<math>t_p</math>)</b>	30 seconds max.	
<b>Ramp-down Rate</b>	6°C/second max	
<b>Time 25°C to peak Temperature (<math>T_p</math>)</b>	8 minutes max.	
<b>Do not exceed</b>	280°C	

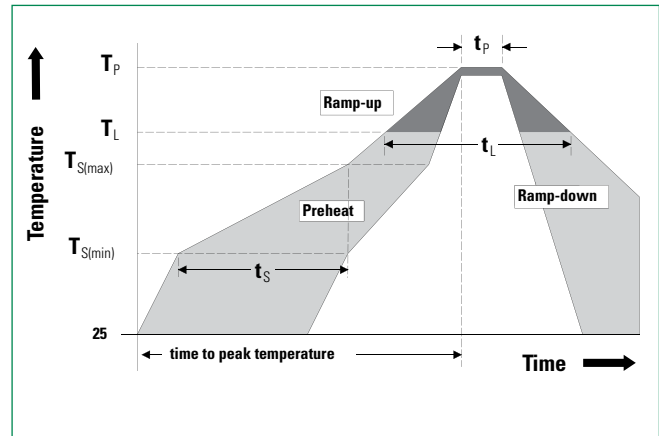

### Physical Specifications

<b>Terminal Finish</b>	100% Matte Tin-plated
<b>Body Material</b>	UL Recognized compound meeting flammability rating V-0
<b>Terminal Material</b>	Copper Alloy

### Design Considerations

Careful selection of the correct component for the application's operating parameters and environment will go a long way toward extending the operating life of the Thyristor. Good design practice should limit the maximum continuous current through the main terminals to 75% of the component rating. Other ways to ensure long life for a power discrete semiconductor are proper heat sinking and selection of voltage ratings for worst case conditions. Overheating, overvoltage (including dv/dt), and surge currents are the main killers of semiconductors. Correct mounting, soldering, and forming of the leads also help protect against component damage.

### Environmental Specifications

Test	Specifications and Conditions
<b>AC Blocking (<math>V_{DRM}</math>)</b>	MIL-STD-750, M-1040, Cond A Applied Peak AC voltage @ 150°C for 1008 hours
<b>Temperature Cycling</b>	MIL-STD-750, M-1051, 100 cycles; -55°C to +150°C; 15-min dwell-time
<b>Temperature/Humidity</b>	EIA / JEDEC, JESD22-A101 1008 hours; 160V - DC; 85°C; 85% rel humidity
<b>High Temp Storage</b>	MIL-STD-750, M-1031, 1008 hours; 150°C
<b>Low-Temp Storage</b>	1008 hours; -40°C
<b>Resistance to Solder Heat</b>	MIL-STD-750 Method 2031
<b>Solderability</b>	ANSI/J-STD-002, category 3, Test A
<b>Lead Bend</b>	MIL-STD-750, M-2036 Cond E

# LJxx04xx & QJxx04xx Series

## 4 Amp High Temperature Sensitive & Standard Triacs

### Dimensions – TO-251AA (V-Package) – V-PAK Through Hole

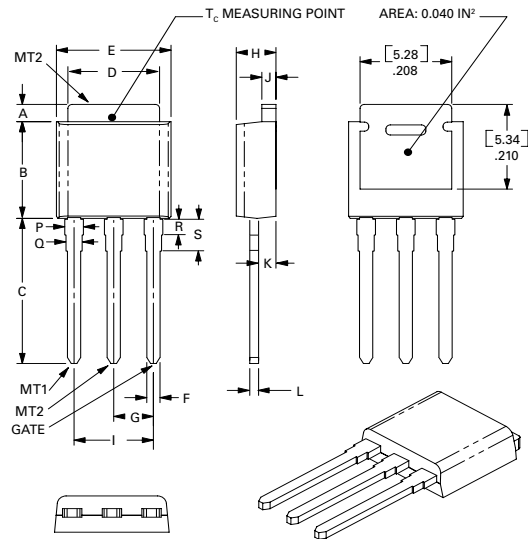

Dimension	Inches			Millimeters		
	Min	Typ	Max	Min	Typ	Max
A	0.037	0.040	0.043	0.94	1.01	1.09
B	0.235	0.242	0.245	5.97	6.15	6.22
C	0.350	0.361	0.375	8.89	9.18	9.53
D	0.205	0.208	0.213	5.21	5.29	5.41
E	0.255	0.262	0.265	6.48	6.66	6.73
F	0.027	0.031	0.033	0.69	0.80	0.84
G	0.087	0.090	0.093	2.21	2.28	2.36
H	0.085	0.092	0.095	2.16	2.34	2.41
I	0.176	0.180	0.184	4.47	4.57	4.67
J	0.018	0.020	0.023	0.46	0.51	0.58
K	0.035	0.037	0.039	0.90	0.95	1.00
L	0.018	0.020	0.023	0.46	0.52	0.58
P	0.042	0.047	0.052	1.06	1.20	1.32
Q	0.034	0.039	0.044	0.86	1.00	1.11
R	0.034	0.039	0.044	0.86	1.00	1.11
S	0.074	0.079	0.084	1.86	2.00	2.11

### Dimensions – TO-252AA (D-Package) – D-PAK Surface Mount

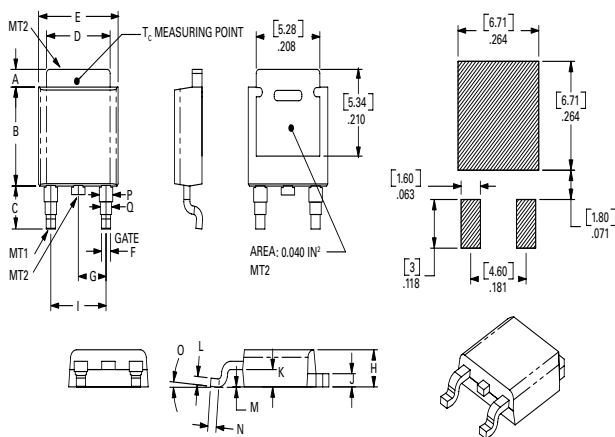

Dimension	Inches			Millimeters		
	Min	Typ	Max	Min	Typ	Max
A	0.037	0.040	0.043	0.94	1.01	1.09
B	0.235	0.243	0.245	5.97	6.16	6.22
C	0.106	0.108	0.113	2.69	2.74	2.87
D	0.205	0.208	0.213	5.21	5.29	5.41
E	0.255	0.262	0.265	6.48	6.65	6.73
F	0.027	0.031	0.033	0.69	0.80	0.84
G	0.087	0.090	0.093	2.21	2.28	2.36
H	0.085	0.092	0.095	2.16	2.33	2.41
I	0.176	0.179	0.184	4.47	4.55	4.67
J	0.018	0.020	0.023	0.46	0.51	0.58
K	0.035	0.037	0.039	0.90	0.95	1.00
L	0.018	0.020	0.023	0.46	0.51	0.58
M	0.000	0.000	0.004	0.00	0.00	0.10
N	0.021	0.026	0.027	0.53	0.67	0.69
O	0°	0°	5°	0°	0°	5°
P	0.042	0.047	0.052	1.06	1.20	1.32
Q	0.034	0.039	0.044	0.86	1.00	1.11

# LJxx04xx & QJxx04xx Series

## 4 Amp High Temperature Sensitive & Standard Triacs

### Product Selector

Part Number	Voltage		Gate Sensitivity Quadrants		Type	Package
	400V	600V	I – II – III	IV		
LJxx04D8	x	x	10mA	20mA	Sensitive Triac	TO-252 D-PAK
LJxx04V8	x	x	10mA	20mA	Sensitive Triac	TO-251 V-PAK
QJxx04D3	x	x	10mA	25mA	Standard Triac	TO-252 D-PAK
QJxx04V3	x	x	10mA	25mA	Standard Triac	TO-251 V-PAK
QJxx04D4	x	x	25mA	50mA	Standard Triac	TO-252 D-PAK
QJxx04V4	x	x	25mA	50mA	Standard Triac	TO-251 V-PAK

Note: xx=voltage/10

### Packing Options

Part Number	Marking	Weight	Packing Mode	Base Quantity
LJxx04D8TP	LJxx04D8	0.3g	Tube Pack	750(75 per tube)
LJxx04D8RP	LJxx04D8	0.3g	Embossed Carrier	2500
LJxx04V8TP	LJxx04V8	0.4g	Tube Pack	750(75 per tube)
QJxx04D3TP	QJxx04D3	0.3g	Tube Pack	750(75 per tube)
QJxx04D3RP	QJxx04D3	0.3g	Embossed Carrier	2500
QJxx04V3TP	QJxx04V3	0.4g	Tube Pack	750(75 per tube)
QJxx04D4TP	QJxx04D4	0.3g	Tube Pack	750(75 per tube)
QJxx04D4RP	QJxx04D4	0.3g	Embossed Carrier	2500
QJxx04V4TP	QJxx04V4	0.4g	Tube Pack	750(75 per tube)

Note: xx=voltage/10

### Part Numbering System

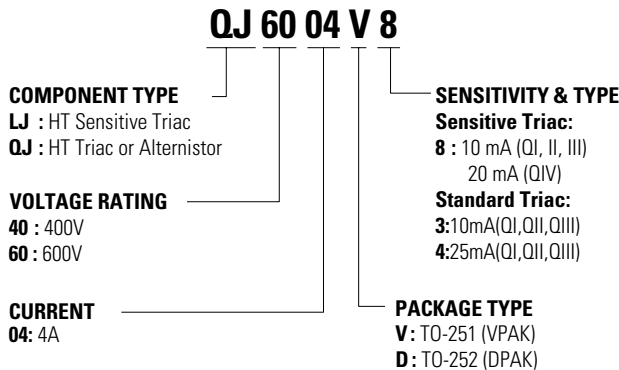

### Part Marking System

