

Lxx06xx & Qxx06xx & Qxx06xHx Series

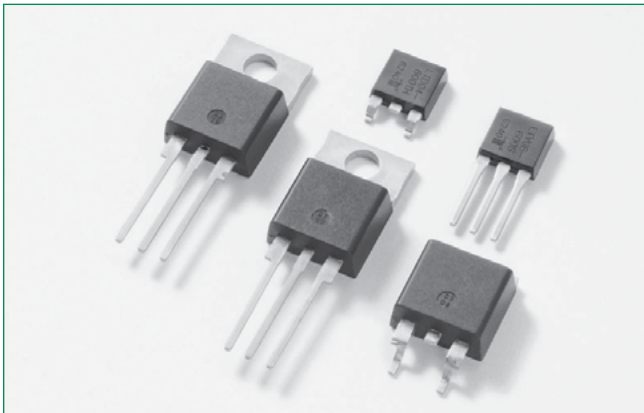

Description

This 6 Amp bidirectional solid state switch series is designed for AC switching and phase control applications such as motor speed and temperature modulation controls, lighting controls, and static switching relays.

Sensitive type components guarantee gate control in Quadrants I & IV as needed for digital control circuitry.

Standard type components normally operate in Quadrants I & III triggered from AC line.

Alternistor type components only operate in quadrants I, II, & III and are used in circuits requiring high dv/dt capability.

Agency Approval

| Agency | Agency File Number |
|--------|--------------------|
| | E71639* |

* - L Package Only

Main Features

| Symbol | Value | Unit |
|-------------------|-----------------------|------|
| $I_{T(RMS)}$ | 6 | A |
| V_{DRM}/V_{RRM} | 400, 600, 800 or 1000 | V |
| $I_{GT(Q1)}$ | 5 to 50 | mA |

Features & Benefits

- RoHS-compliant
- Glass – passivated junctions
- Voltage capability up to 1000 V
- Surge capability up to 85 A
- The Lpackage has an isolation rating of 2500V_{RMS}
- Solid-state switching eliminates arcing or contact bounce that create voltage transients
- No contacts to wear out from reaction of switching events
- Restricted (or limited) RFI generation, depending on activation point of sine wave
- Only requires a short gate activation pulse during each half-cycle
- UL Recognized as an Electrically Isolated Semiconductor Device to UL 1557.

Schematic Symbol

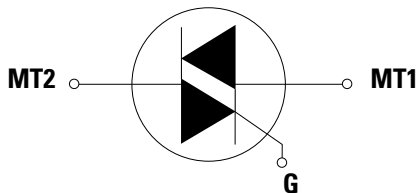

Applications

Excellent for AC switching and phase control applications such as heating, lighting, and motor speed controls.

Typical applications are AC solid-state switches, light dimmers, power tools, home/brown goods and white goods appliances.

Alternistor Triacs (no snubber required) are used in applications with extremely inductive loads requiring the highest commutation performance.

Internally constructed isolated packages are offered for ease of heat sinking with highest isolation voltage.

Additional Information



Datasheet



Resources



Samples

Absolute Maximum Ratings — Sensitive Triac (4 Quadrants)

| Symbol | Parameter | | Value | Unit | |
|--------------|--------------------------------------------------------------------------------------------------|--------------------------------------------|------------------------------------------------------|------------|------------------------|
| $I_{T(RMS)}$ | RMS on-state current (full sine wave) | Lxx06Ly/Lxx06Vy/Lxx06Dy Lxx06Ry/Lxx06Ny | $T_c = 80^\circ\text{C}$ $T_c = 85^\circ\text{C}$ | 6 A | |
| I_{TSM} | Non repetitive surge peak on-state current (full cycle, T_j initial = 25°C) | $f = 50\text{ Hz}$ | $t = 20\text{ ms}$ | 50 | A |
| | | $f = 60\text{ Hz}$ | $t = 16.7\text{ ms}$ | 60 | |
| I^2t | I^2t Value for fusing | $t_p = 8.3\text{ ms}$ | | 15 | A^2s |
| di/dt | Critical rate of rise of on-state current $I_g = 50\text{mA}$ with $0.1\mu\text{s}$ rise time | $f = 120\text{ Hz}$ | $T_j = 110^\circ\text{C}$ | 70 | $\text{A}/\mu\text{s}$ |
| I_{GTM} | Peak gate trigger current | $t_p = 20\mu\text{s}$ | $T_j = 110^\circ\text{C}$ | 4 | A |
| $P_{G(AV)}$ | Average gate power dissipation | | $T_j = 110^\circ\text{C}$ | 0.4 | W |
| T_{stg} | Storage temperature range | | | -40 to 150 | $^\circ\text{C}$ |
| T_j | Operating junction temperature range | | | -40 to 110 | $^\circ\text{C}$ |

Note: xx = voltage/10, y = sensitivity

Absolute Maximum Ratings — Standard Triac

| Symbol | Parameter | | Value | Unit | |
|--------------|---------------------------------------------------------------------------------------------------|-----------------------|---------------------------|------------|------------------------|
| $I_{T(RMS)}$ | RMS on-state current (full sine wave) | Qxx06Ry / Qxx06Ny | $T_c = 95^\circ\text{C}$ | 6 | A |
| | | Qxx06Ly | $T_c = 90^\circ\text{C}$ | | |
| I_{TSM} | Non repetitive surge peak on-state current (full cycle, T_j initial = 25°C) | $f = 50\text{ Hz}$ | $t = 20\text{ ms}$ | 65 | A |
| | | $f = 60\text{ Hz}$ | $t = 16.7\text{ ms}$ | 80 | |
| I^2t | I^2t Value for fusing | $t_p = 8.3\text{ ms}$ | | 26.5 | A^2s |
| di/dt | Critical rate of rise of on-state current $I_g = 200\text{mA}$ with $0.1\mu\text{s}$ rise time | $f = 120\text{ Hz}$ | $T_j = 125^\circ\text{C}$ | 70 | $\text{A}/\mu\text{s}$ |
| I_{GTM} | Peak gate trigger current | $t_p = 20\mu\text{s}$ | $T_j = 125^\circ\text{C}$ | 4 | A |
| $P_{G(AV)}$ | Average gate power dissipation | | $T_j = 125^\circ\text{C}$ | 0.5 | W |
| T_{stg} | Storage temperature range | | | -40 to 150 | $^\circ\text{C}$ |
| T_j | Operating junction temperature range | | | -40 to 125 | $^\circ\text{C}$ |

Note: xx = voltage/10, y = sensitivity

Absolute Maximum Ratings — Alternistor Triac (3 Quadrants)

| Symbol | Parameter | | Value | Unit | | |
|--------------|-------------------------------------------------------------------------------------------------|-----------------------------------------------|---------------------------|----------------------------------|------------------------|----------------------|
| $I_{T(RMS)}$ | RMS on-state current (full sine wave) | Qxx06LHy/Qxx06VHy/Qxx06DHy | $T_c = 95^\circ\text{C}$ | 6 | A | |
| | | Qxx06RHy/Qxx06NHy | $T_c = 100^\circ\text{C}$ | | | |
| I_{TSM} | Non repetitive surge peak on-state current (full cycle, T_j initial = 25°C) | $f = 50\text{ Hz}$ | $t = 20\text{ ms}$ | Qxx06VHy Qxx06DHy | 55 | A |
| | | | | Qxx06LHy Qxx06RHy Qxx06NHy | 80 | |
| | | $f = 60\text{ Hz}$ | $t = 16.7\text{ ms}$ | Qxx06VHy Qxx06DHy | 65 | |
| | | | | Qxx06LHy Qxx06RHy Qxx06NHy | 85 | |
| I^2t | I^2t Value for fusing | $t_p = 8.3\text{ ms}$ | | Qxx06VHy Qxx06DHy | 17.5 | A^2s |
| | | | | Qxx06LHy Qxx06RHy Qxx06NHy | 30 | |
| di/dt | Critical rate of rise of on-state current | $f = 120\text{ Hz}$ | $T_j = 125^\circ\text{C}$ | 70 | $\text{A}/\mu\text{s}$ | |
| I_{GTM} | Peak gate trigger current | $t_p \leq 10\mu\text{s}; I_{GT} \leq I_{GTM}$ | | $T_j = 125^\circ\text{C}$ | 1.6 | A |
| $P_{G(AV)}$ | Average gate power dissipation | | $T_j = 125^\circ\text{C}$ | 0.5 | W | |
| T_{stg} | Storage temperature range | | | -40 to 150 | $^\circ\text{C}$ | |
| T_j | Operating junction temperature range | | | -40 to 125 | $^\circ\text{C}$ | |

Note: xx = voltage/10, y = sensitivity

Electrical Characteristics ($T_J = 25^\circ\text{C}$, unless otherwise specified) — Sensitive Triac (4 Quadrants)

| Symbol | Test Conditions | Quadrant | | Value | | | Unit |
|----------|-------------------------------------------------------------------------|--------------------|------|----------|----------|----------|------------------|
| | | | | Lxx06x5 | Lxx06x6 | Lxx06x8 | |
| I_{GT} | $V_D = 12V$ $R_L = 60\ \Omega$ | I – II – III IV | MAX. | 5 5 | 5 10 | 10 20 | mA |
| V_{GT} | $V_D = 12V$ $R_L = 60\ \Omega$ | ALL | MAX. | 1.3 | | | V |
| V_{GD} | $V_D = V_{DRM}$ $R_L = 3.3\ \text{k}\Omega$ $T_J = 110^\circ\text{C}$ | ALL | MIN. | 0.2 | | | V |
| I_H | $I_T = 100\text{mA}$ | | MAX. | 10 | 10 | 20 | mA |
| dv/dt | $V_D = V_{DRM}$ Gate Open $T_J = 100^\circ\text{C}$ | 400V 600V | TYP. | 30 20 | 30 20 | 40 30 | V/ μs |
| (dv/dt)c | (di/dt)c = 3.2 A/ms $T_J = 110^\circ\text{C}$ | | TYP. | 1 | 2 | 2 | V/ μs |
| t_{gt} | $I_G = 2 \times I_{GT}$ PW = 15 μs $I_T = 8.5\ \text{A(pk)}$ | | TYP. | 3.0 | 3.0 | 3.2 | μs |

Electrical Characteristics ($T_J = 25^\circ\text{C}$, unless otherwise specified) — Standard Triac

| Symbol | Test Conditions | Quadrant | | Value | | Unit |
|----------|-------------------------------------------------------------------------|----------------------|--------------|----------|-----------|------------------|
| | | | | Qxx06x4 | Qxx06x5 | |
| I_{GT} | $V_D = 12V$ $R_L = 60\ \Omega$ | I – II – III IV | MAX. TYP. | 25 50 | 50 75 | mA |
| V_{GT} | $V_D = 12V$ $R_L = 60\ \Omega$ | I – II – III | MAX. | 1.3 | | V |
| V_{GD} | $V_D = V_{DRM}$ $R_L = 3.3\ \text{k}\Omega$ $T_J = 125^\circ\text{C}$ | ALL | MIN. | 0.2 | | V |
| I_H | $I_T = 200\text{mA}$ | | MAX. | 50 | 50 | mA |
| dv/dt | $V_D = V_{DRM}$ Gate Open $T_J = 125^\circ\text{C}$ | 400V 600V 800V | MIN. | 120 | 100 85 | V/ μs |
| | $V_D = V_{DRM}$ Gate Open $T_J = 100^\circ\text{C}$ | 1000V | | 100 | | |
| (dv/dt)c | (di/dt)c = 3.2 A/ms $T_J = 125^\circ\text{C}$ | | TYP. | 4 | 4 | V/ μs |
| t_{gt} | $I_G = 2 \times I_{GT}$ PW = 15 μs $I_T = 8.5\ \text{A(pk)}$ | | TYP. | 3.0 | 3.0 | μs |

Electrical Characteristics ($T_J = 25^\circ\text{C}$, unless otherwise specified) — Alternistor Triac (3 Quadrants)

| Symbol | Test Conditions | Quadrant | | Value | | Unit | |
|----------|-------------------------------------------------------------------------|--------------------------------------|------|----------------------|-----------------|-------------------|------------------|
| | | | | Qxx06xH3 | Qxx06xH4 | | |
| I_{GT} | $V_D = 12V$ $R_L = 60\ \Omega$ | I – II – III | MAX. | 10 | 35 | mA | |
| V_{GT} | $V_D = 12V$ $R_L = 60\ \Omega$ | I – II – III | MAX. | 1.3 | | V | |
| V_{GD} | $V_D = V_{DRM}$ $R_L = 3.3\ \text{k}\Omega$ $T_J = 125^\circ\text{C}$ | I – II – III | MIN. | 0.2 | | V | |
| I_H | $I_T = 100\text{mA}$ | | MAX. | 15 | 35 | mA | |
| dv/dt | $V_D = V_{DRM}$ Gate Open $T_J = 125^\circ\text{C}$ | Qxx06VHy / Qxx06DHy | MIN. | 400V 600V 800V | 75 50 200 | 400 300 200 | |
| | $V_D = V_{DRM}$ Gate Open $T_J = 100^\circ\text{C}$ | Qxx06LHy / Qxx06RHy / Qxx06NHy | | 400V 600V 800V | 75 50 | 450 350 250 | |
| | | ALL | | 1000V | | 150 | |
| (dv/dt)c | (di/dt)c = 3.2 A/ms $T_J = 125^\circ\text{C}$ | | | MIN. | 20 | 25 | V/ μs |
| t_{gt} | $I_G = 2 \times I_{GT}$ PW = 15 μs $I_T = 8.5\ \text{A(pk)}$ | | | TYP. | 4.0 | 4.0 | μs |

Note: xx = voltage/10, x = package, y = sensitivity

Static Characteristics

| Symbol | Test Conditions | | Value | Unit | |
|---------------------|------------------------------------|----------|---------------------|-------------|------------|
| V_{TM} | $I_{TM} = 11.3A$ $t_p = 380 \mu s$ | | MAX. | 1.60 V | |
| I_{DRM} / I_{RRM} | $V_{DRM} = V_{RRM}$ | Lxx06xy | $T_J = 25^\circ C$ | 400 - 600V | 20 μA |
| | | | $T_J = 110^\circ C$ | 400 - 600V | 0.5 mA |
| | | Qxx06xy | $T_J = 25^\circ C$ | 400 - 1000V | 50 μA |
| | | | $T_J = 125^\circ C$ | 400 - 800V | 2 mA |
| | | | $T_J = 100^\circ C$ | 1000V | 3 mA |
| | | Qxx06xHy | $T_J = 25^\circ C$ | 400 - 800V | 10 μA |
| | | | | 1000V | 20 μA |
| | | | $T_J = 125^\circ C$ | 400 - 800V | 3 mA |
| | | | $T_J = 100^\circ C$ | 1000V | 2 mA |

Thermal Resistances

| Symbol | Parameter | Value | Unit |
|-------------------|-----------------------|-------------------------|------|
| $R_{\theta(J-C)}$ | Junction to case (AC) | L/Qxx06Ryy / L/Qxx06Nyy | 1.8 |
| | | L/Qxx06Ly | 3.3 |
| | | L/Qxx06Vyy / L/Qxx06Dyy | 3.2 |
| $R_{\theta(J-A)}$ | Junction to ambient | L/Qxx06Ryy | 45 |
| | | L/Qxx06Ly | 50 |
| | | L/Qxx06Vyy | 70 |

Note: xx = voltage, x = package, y = sensitivity, yy = type & sensitivity

Figure 1: Definition of Quadrants

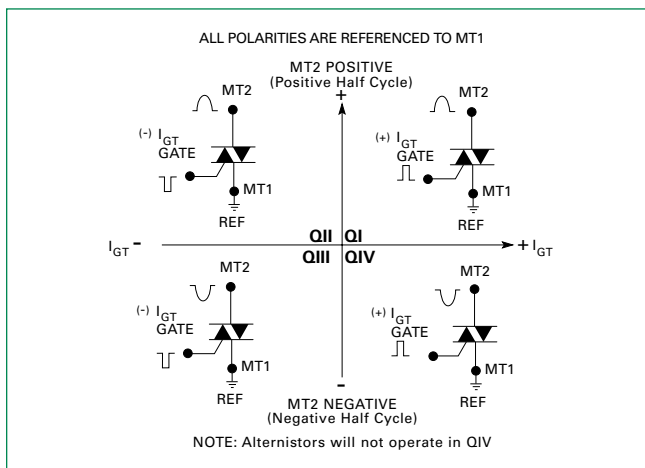

Note: Alternistors will not operate in QIV

Figure 2: Normalized DC Gate Trigger Current for All Quadrants vs. Junction Temperature

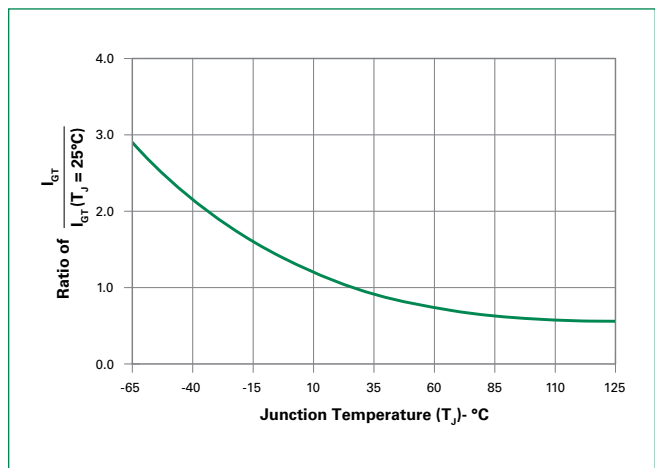

Figure 3: Normalized DC Holding Current vs. Junction Temperature

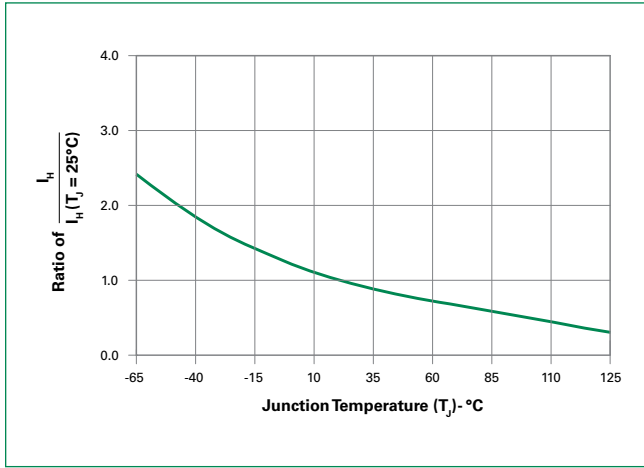

Figure 4: Normalized DC Gate Trigger Voltage for All Quadrants vs. Junction Temperature

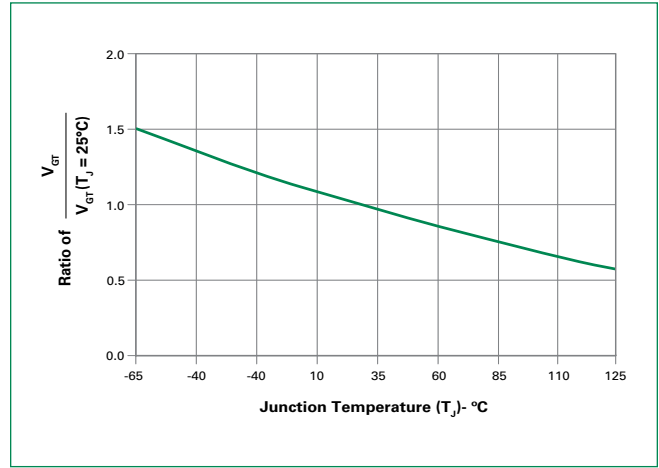

Figure 5: Power Dissipation (Typical) vs. RMS On-State Current

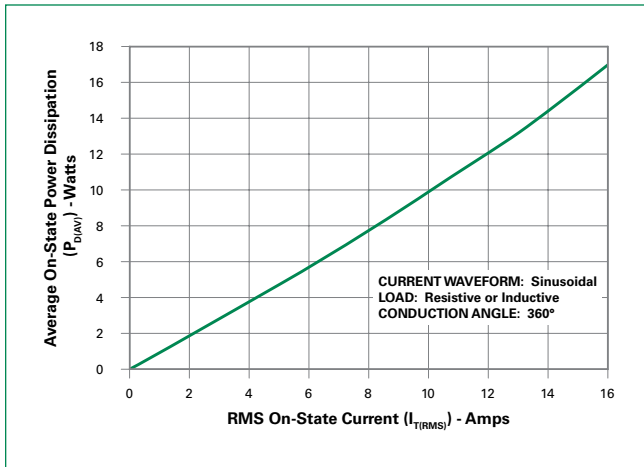

Figure 6: Maximum Allowable Case Temperature vs. On-State Current (Sensitive Triac)

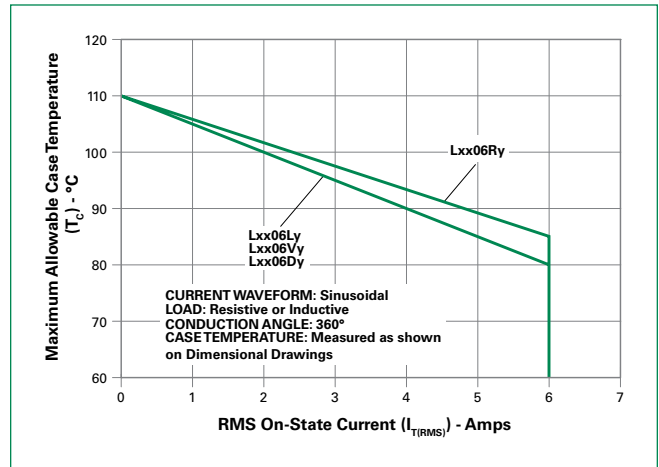

Figure 7: Maximum Allowable Case Temperature vs. On-State Current (Standard Triac)

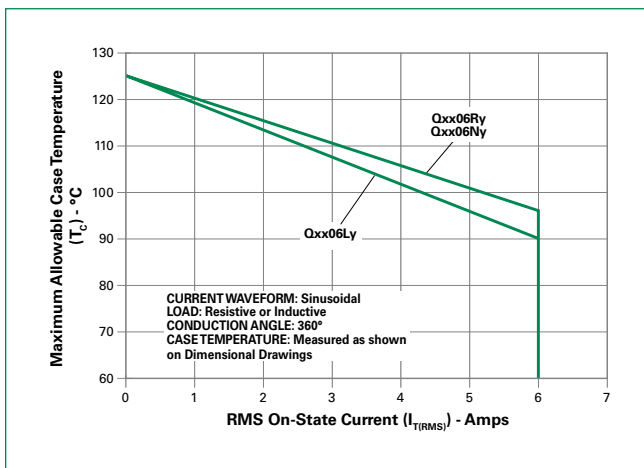

Figure 8: Maximum Allowable Case Temperature vs. On-State Current (Alternistor Triac)

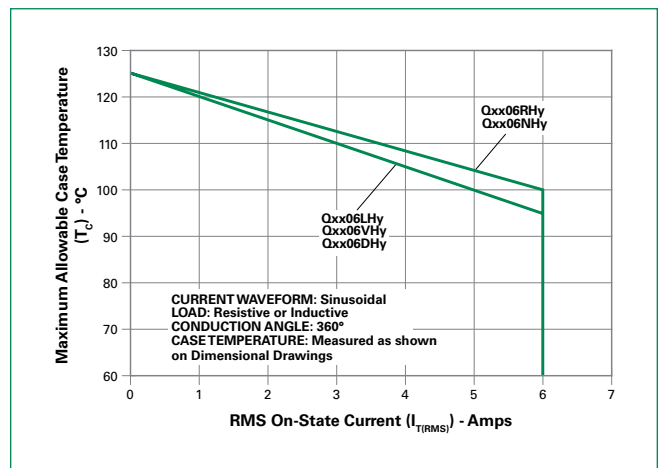

Figure 9: Maximum Allowable Ambient Temperature vs. On-State Current (Sensitive / Standard Triac)

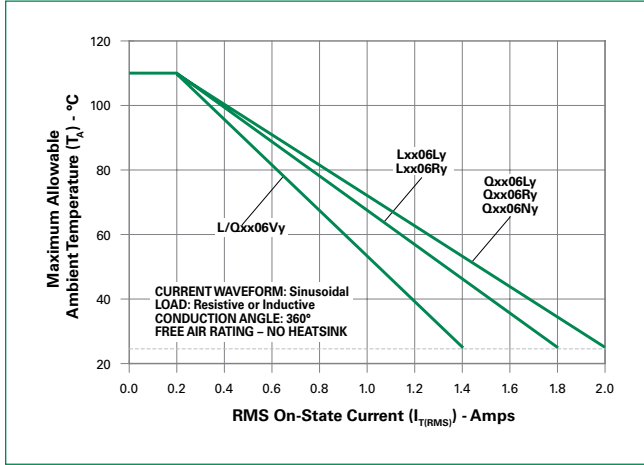

Figure 10: Maximum Allowable Ambient Temperature vs. On-State Current (Alternistor Triac)

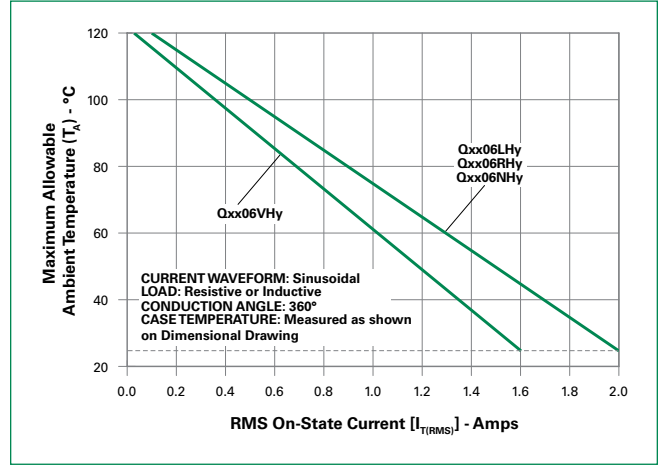

Figure 11: On-State Current vs. On-State Voltage (Typical)

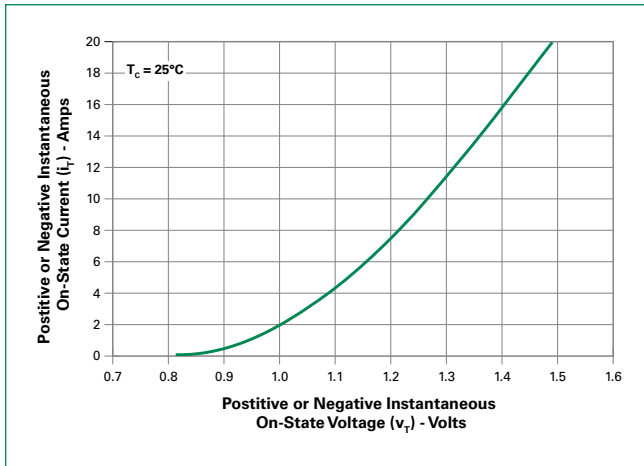

Figure 12: Surge Peak On-State Current vs. Number of Cycles (Sensitive / Standard Triac)

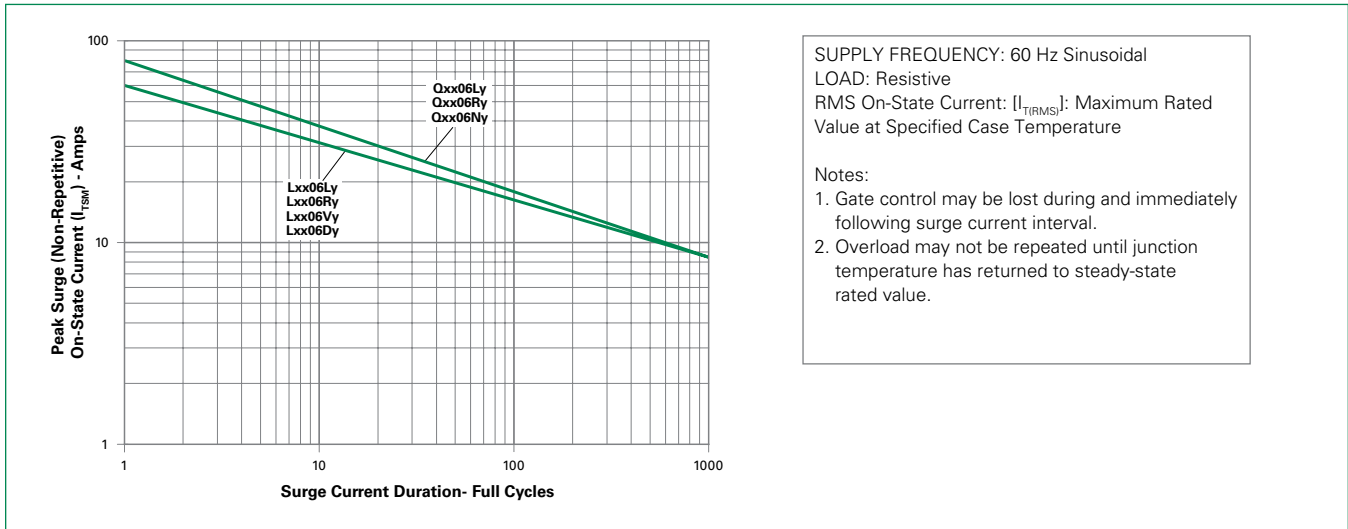
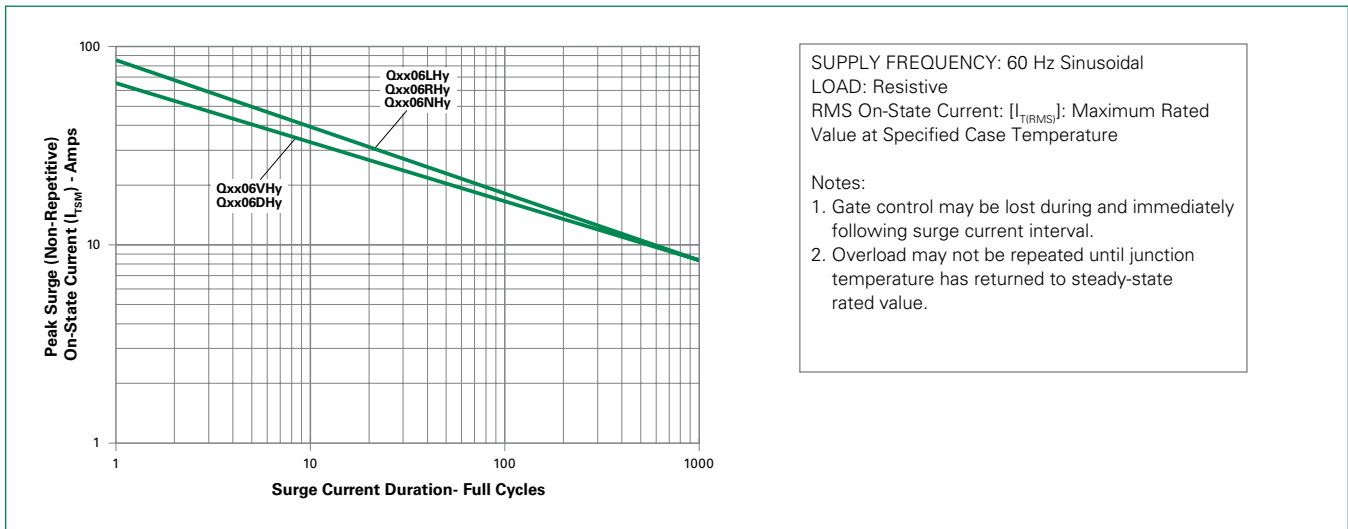

Figure 13: Surge Peak On-State Current vs. Number of Cycles (Alternistor Triac)



Note: xx = voltage/10, x = package, y = sensitivity.

Soldering Parameters

| | | |
|------------------------------------------------------------------------|------------------------------------|-------------------------|
| Reflow Condition | | Pb – Free assembly |
| Pre Heat | - Temperature Min ($T_{s(min)}$) | 150°C |
| | - Temperature Max ($T_{s(max)}$) | 200°C |
| | - Time (min to max) (t_s) | 60 – 120 secs |
| Average ramp up rate (Liquidus Temp) (T_L) to peak | | 3°C/second max |
| $T_{S(max)}$ to T_L - Ramp-up Rate | | 3°C/second max |
| Reflow | - Temperature (T_L) (Liquidus) | 217°C |
| | - Temperature (t_L) | 60 – 150 seconds |
| Peak Temperature (T_p) | | 260 ^{+0/-5} °C |
| Time within 5°C of actual peak Temperature (t_p) | | 30 seconds |
| Ramp-down Rate | | 6°C/second max |
| Time 25°C to peak Temperature (T_p) | | 8 minutes Max. |
| Do not exceed | | 280°C |

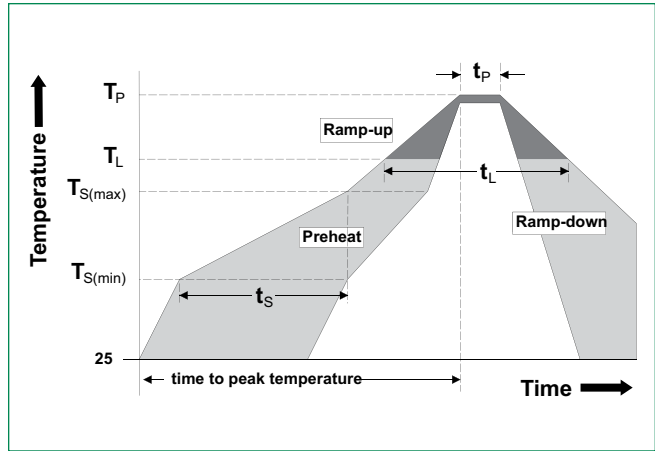

Physical Specifications

| | |
|--------------------------|--------------------------------------------------------|
| Terminal Finish | 100% Matte Tin-plated |
| Body Material | UL Recognized compound meeting flammability rating V-0 |
| Terminal Material | Copper Alloy |

Design Considerations

Careful selection of the correct components for the application's operating parameters and environment will go a long way toward extending the operating life of the Thyristor. Good design practice should limit the maximum continuous current through the main terminals to 75% of the components rating. Other ways to ensure long life for a power discrete semiconductor are proper heat sinking and selection of voltage ratings for worst case conditions. Overheating, overvoltage (including dv/dt), and surge currents are the main killers of semiconductors. Correct mounting, soldering, and forming of the leads also help protect against component damage.

Environmental Specifications

| Test | Specifications and Conditions |
|-------------------------------------------|----------------------------------------------------------------------------|
| AC Blocking (V_{DRM}) | MIL-STD-750, M-1040, Cond A Applied Peak AC voltage @ 125°C for 1008 hours |
| Temperature Cycling | MIL-STD-750, M-1051, 100 cycles; -40°C to +150°C; 15-min dwell-time |
| Temperature/Humidity | EIA / JEDEC, JESD22-A101 1008 hours; 320V - DC: 85°C; 85% rel humidity |
| High Temp Storage | MIL-STD-750, M-1031, 1008 hours; 150°C |
| Low-Temp Storage | 1008 hours; -40°C |
| Resistance to Solder Heat | MIL-STD-750 Method 2031 |
| Solderability | ANSI/J-STD-002, category 3, Test A |
| Lead Bend | MIL-STD-750, M-2036 Cond E |

Dimensions — TO-220AB (R-Package) — Non-Isolated Mounting Tab Common with Center Lead

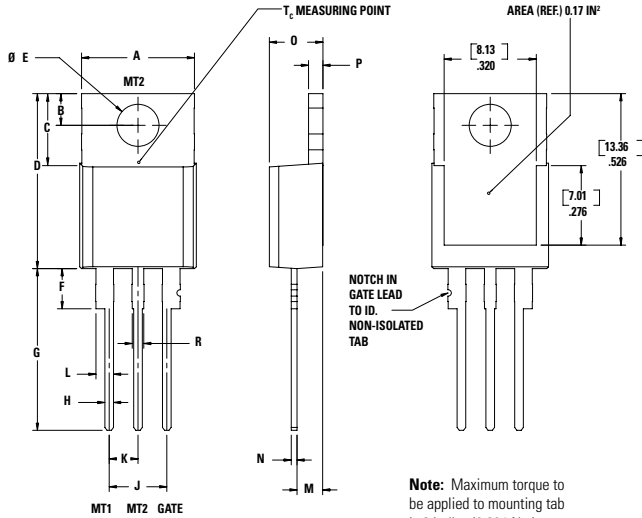

| Dimension | Inches | | Millimeters | |
|-----------|--------|-------|-------------|-------|
| | Min | Max | Min | Max |
| A | 0.380 | 0.420 | 9.65 | 10.67 |
| B | 0.105 | 0.115 | 2.67 | 2.92 |
| C | 0.230 | 0.250 | 5.84 | 6.35 |
| D | 0.590 | 0.620 | 14.99 | 15.75 |
| E | 0.142 | 0.147 | 3.61 | 3.73 |
| F | 0.110 | 0.130 | 2.79 | 3.30 |
| G | 0.540 | 0.575 | 13.72 | 14.61 |
| H | 0.025 | 0.035 | 0.64 | 0.89 |
| J | 0.195 | 0.205 | 4.95 | 5.21 |
| K | 0.095 | 0.105 | 2.41 | 2.67 |
| L | 0.060 | 0.075 | 1.52 | 1.91 |
| M | 0.085 | 0.095 | 2.16 | 2.41 |
| N | 0.018 | 0.024 | 0.46 | 0.61 |
| O | 0.178 | 0.188 | 4.52 | 4.78 |
| P | 0.045 | 0.060 | 1.14 | 1.52 |
| R | 0.038 | 0.048 | 0.97 | 1.22 |

Dimensions — TO-220AB (L-Package) — Isolated Mounting Tab

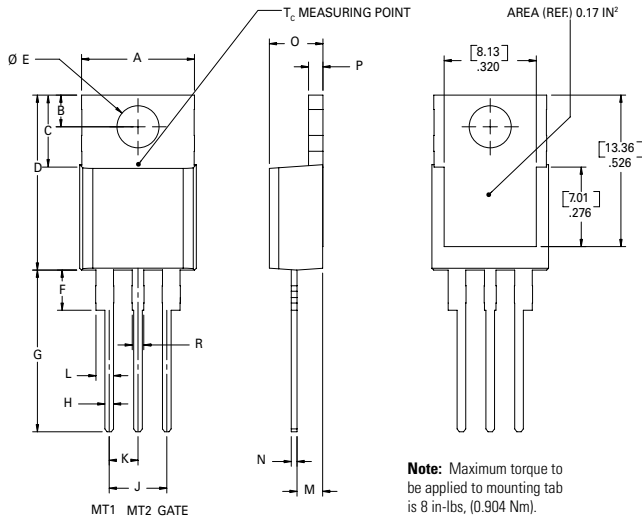

| Dimension | Inches | | Millimeters | |
|-----------|--------|-------|-------------|-------|
| | Min | Max | Min | Max |
| A | 0.380 | 0.420 | 9.65 | 10.67 |
| B | 0.105 | 0.115 | 2.67 | 2.92 |
| C | 0.230 | 0.250 | 5.84 | 6.35 |
| D | 0.590 | 0.620 | 14.99 | 15.75 |
| E | 0.142 | 0.147 | 3.61 | 3.73 |
| F | 0.110 | 0.130 | 2.79 | 3.30 |
| G | 0.540 | 0.575 | 13.72 | 14.61 |
| H | 0.025 | 0.035 | 0.64 | 0.89 |
| J | 0.195 | 0.205 | 4.95 | 5.21 |
| K | 0.095 | 0.105 | 2.41 | 2.67 |
| L | 0.060 | 0.075 | 1.52 | 1.91 |
| M | 0.085 | 0.095 | 2.16 | 2.41 |
| N | 0.018 | 0.024 | 0.46 | 0.61 |
| O | 0.178 | 0.188 | 4.52 | 4.78 |
| P | 0.045 | 0.060 | 1.14 | 1.52 |
| R | 0.038 | 0.048 | 0.97 | 1.22 |

Dimensions – TO-263AB (N-Package) – D²-PAK Surface Mount

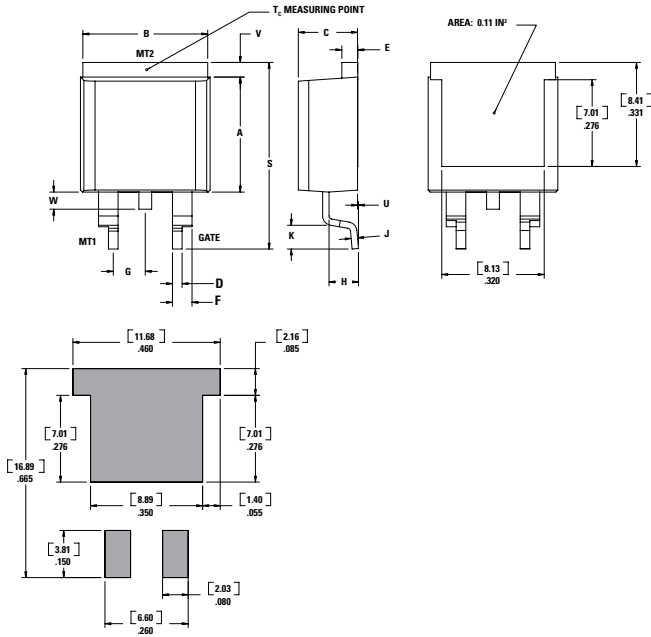

| Dimension | Inches | | Millimeters | |
|-----------|--------|-------|-------------|-------|
| | Min | Max | Min | Max |
| A | 0.360 | 0.370 | 9.14 | 9.40 |
| B | 0.380 | 0.420 | 9.65 | 10.67 |
| C | 0.178 | 0.188 | 4.52 | 4.78 |
| D | 0.025 | 0.035 | 0.64 | 0.89 |
| E | 0.045 | 0.060 | 1.14 | 1.52 |
| F | 0.060 | 0.075 | 1.52 | 1.91 |
| G | 0.095 | 0.105 | 2.41 | 2.67 |
| H | 0.092 | 0.102 | 2.34 | 2.59 |
| J | 0.018 | 0.024 | 0.46 | 0.61 |
| K | 0.090 | 0.110 | 2.29 | 2.79 |
| S | 0.590 | 0.625 | 14.99 | 15.88 |
| V | 0.035 | 0.045 | 0.89 | 1.14 |
| U | 0.002 | 0.010 | 0.05 | 0.25 |
| W | 0.040 | 0.070 | 1.02 | 1.78 |

Dimensions – TO-251AA (V-Package) – V-PAK Through Hole

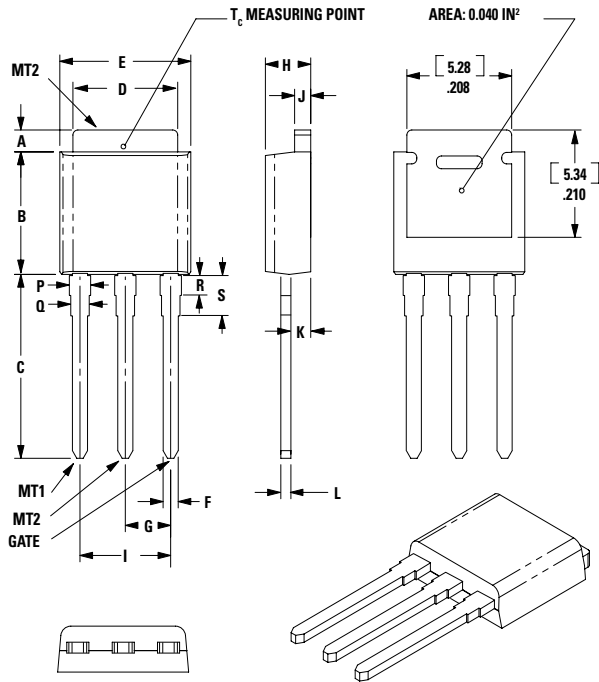

| Dimension | Inches | | | Millimeters | | |
|-----------|--------|-------|-------|-------------|------|------|
| | Min | Typ | Max | Min | Typ | Max |
| A | 0.037 | 0.040 | 0.043 | 0.94 | 1.01 | 1.09 |
| B | 0.235 | 0.242 | 0.245 | 5.97 | 6.15 | 6.22 |
| C | 0.350 | 0.361 | 0.375 | 8.89 | 9.18 | 9.53 |
| D | 0.205 | 0.208 | 0.213 | 5.21 | 5.29 | 5.41 |
| E | 0.255 | 0.262 | 0.265 | 6.48 | 6.66 | 6.73 |
| F | 0.027 | 0.031 | 0.033 | 0.69 | 0.80 | 0.84 |
| G | 0.087 | 0.090 | 0.093 | 2.21 | 2.28 | 2.36 |
| H | 0.085 | 0.092 | 0.095 | 2.16 | 2.34 | 2.41 |
| I | 0.176 | 0.180 | 0.184 | 4.47 | 4.57 | 4.67 |
| J | 0.018 | 0.020 | 0.023 | 0.46 | 0.51 | 0.58 |
| K | 0.035 | 0.037 | 0.039 | 0.90 | 0.95 | 1.00 |
| L | 0.018 | 0.020 | 0.023 | 0.46 | 0.52 | 0.58 |
| P | 0.042 | 0.047 | 0.052 | 1.06 | 1.20 | 1.32 |
| Q | 0.034 | 0.039 | 0.044 | 0.86 | 1.00 | 1.11 |
| R | 0.034 | 0.039 | 0.044 | 0.86 | 1.00 | 1.11 |
| S | 0.074 | 0.079 | 0.084 | 1.86 | 2.00 | 2.11 |

Dimensions — TO-252AA (D-Package) — D-PAK Surface mount

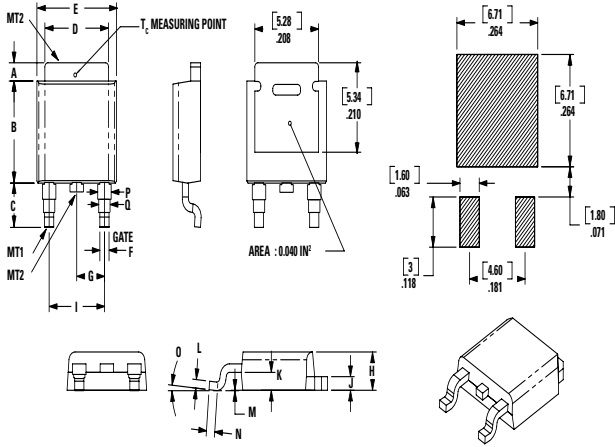

| Dimension | Inches | | | Millimeters | | |
|-----------|--------|-------|-------|-------------|------|------|
| | Min | Typ | Max | Min | Typ | Max |
| A | 0.037 | 0.040 | 0.043 | 0.94 | 1.01 | 1.09 |
| B | 0.235 | 0.243 | 0.245 | 5.97 | 6.16 | 6.22 |
| C | 0.106 | 0.108 | 0.113 | 2.69 | 2.74 | 2.87 |
| D | 0.205 | 0.208 | 0.213 | 5.21 | 5.29 | 5.41 |
| E | 0.255 | 0.262 | 0.265 | 6.48 | 6.65 | 6.73 |
| F | 0.027 | 0.031 | 0.033 | 0.69 | 0.80 | 0.84 |
| G | 0.087 | 0.090 | 0.093 | 2.21 | 2.28 | 2.36 |
| H | 0.085 | 0.092 | 0.095 | 2.16 | 2.33 | 2.41 |
| I | 0.176 | 0.179 | 0.184 | 4.47 | 4.55 | 4.67 |
| J | 0.018 | 0.020 | 0.023 | 0.46 | 0.51 | 0.58 |
| K | 0.035 | 0.037 | 0.039 | 0.90 | 0.95 | 1.00 |
| L | 0.018 | 0.020 | 0.023 | 0.46 | 0.51 | 0.58 |
| M | 0.000 | 0.000 | 0.004 | 0.00 | 0.00 | 0.10 |
| N | 0.021 | 0.026 | 0.027 | 0.53 | 0.67 | 0.69 |
| O | 0° | 0° | 5° | 0° | 0° | 5° |
| P | 0.042 | 0.047 | 0.052 | 1.06 | 1.20 | 1.32 |
| Q | 0.034 | 0.039 | 0.044 | 0.86 | 1.00 | 1.11 |

Product Selector

| Part Number | Voltage | | | | Gate Sensitivity Quadrants | | Type | Package |
|-------------|---------|------|------|-------|----------------------------|-------|-------------------|----------------------------|
| | 400V | 600V | 800V | 1000V | I - II - III | IV | | |
| Lxx06L5 | X | X | - | - | 5 mA | 5 mA | Sensitive Triac | TO-220L |
| Lxx06D5 | X | X | - | - | 5 mA | 5 mA | Sensitive Triac | TO-252 D-PAK |
| Lxx06R5 | X | X | - | - | 5mA | 5mA | Sensitive Triac | TO-220R |
| Lxx06V5 | X | X | - | - | 5 mA | 5 mA | Sensitive Triac | TO-251 V-PAK |
| Lxx06L6 | X | X | - | - | 5 mA | 10 mA | Sensitive Triac | TO-220L |
| Lxx06D6 | X | X | - | - | 5 mA | 10 mA | Sensitive Triac | TO-252 D-PAK |
| Lxx06R6 | X | X | - | - | 5mA | 10mA | Sensitive Triac | TO-220R |
| Lxx06V6 | X | X | - | - | 5 mA | 10 mA | Sensitive Triac | TO-251 V-PAK |
| Lxx06L8 | X | X | - | - | 10 mA | 20 mA | Sensitive Triac | TO-220L |
| Lxx06D8 | X | X | - | - | 10 mA | 20 mA | Sensitive Triac | TO-252 D-PAK |
| Lxx06R8 | X | X | - | - | 10mA | 20mA | Sensitive Triac | TO-220R |
| Lxx06V8 | X | X | - | - | 10 mA | 20 mA | Sensitive Triac | TO-251 V-PAK |
| Qxx06VH3 | X | X | - | - | 10 mA | - | Alternistor Triac | TO-251 V-PAK |
| Qxx06DH3 | X | X | - | - | 10 mA | - | Alternistor Triac | TO-252 D-PAK |
| Qxx06L4 | X | - | - | - | 25 mA | - | Standard Triac | TO-220L |
| Qxx06R4 | X | - | - | - | 25 mA | - | Standard Triac | TO-220R |
| Qxx06N4 | X | - | - | - | 25 mA | - | Standard Triac | TO-263 D ² -PAK |
| Qxx06LH3 | X | X | - | - | 10mA | - | Alternistor Triac | TO-220L |
| Qxx06RH3 | X | X | - | - | 10mA | - | Alternistor Triac | TO-220R |
| Qxx06LH4 | X | X | X | X | 35 mA | - | Alternistor Triac | TO-220L |
| Qxx06RH4 | X | X | X | X | 35 mA | - | Alternistor Triac | TO-220R |
| Qxx06VH4 | X | X | X | X | 35 mA | - | Alternistor Triac | TO-251 V-PAK |
| Qxx06DH4 | X | X | X | X | 35 mA | - | Alternistor Triac | TO-252 D-PAK |
| Qxx06NH4 | X | X | X | X | 35 mA | - | Alternistor Triac | TO-263 D ² -PAK |
| Qxx06L5 | - | X | X | X | 50 mA | - | Standard Triac | TO-220L |
| Qxx06R5 | - | X | X | X | 50 mA | - | Standard Triac | TO-220R |
| Qxx06N5 | - | X | X | X | 50 mA | - | Standard Triac | TO-263 D ² -PAK |

Packing Options

| Part Number | Marking | Weight | Packing Mode | Base Quantity |
|--------------|------------|--------|------------------|--------------------|
| Lxx06L/RyTP | Lxx06L/Ry | 2.2 g | Tube Pack | 1000 (50 per tube) |
| Lxx06DyTP | Lxx06Dy | 0.3 g | Tube | 750 (75 per tube) |
| Lxx06DyRP | Lxx06Dy | 0.3 g | Embossed Carrier | 2500 |
| Lxx06VyTP | Lxx06Vy | 0.4 g | Tube | 750 (75 per tube) |
| Qxx06L/RyyTP | Qxx06L/Ryy | 2.2 g | Tube Pack | 1000 (50 per tube) |
| Qxx06NyyTP | Qxx06Nyy | 1.6 g | Tube | 1000 (50 per tube) |
| Qxx06NyyRP | Qxx06Nyy | 1.6 g | Embossed Carrier | 500 |
| Qxx06DyyTP | Qxx06Dyy | 0.3 g | Tube | 750 (75 per tube) |
| Qxx06DyyRP | Qxx06Dyy | 0.3 g | Embossed Carrier | 2500 |
| Qxx06VyyTP | Qxx06Vyy | 0.4 g | Tube | 750 (75 per tube) |

Note: xx = voltage/10; yy = sensitivity

TO-252 Embossed Carrier Reel Pack (RP) Specifications

Meets all EIA-481-2 Standards

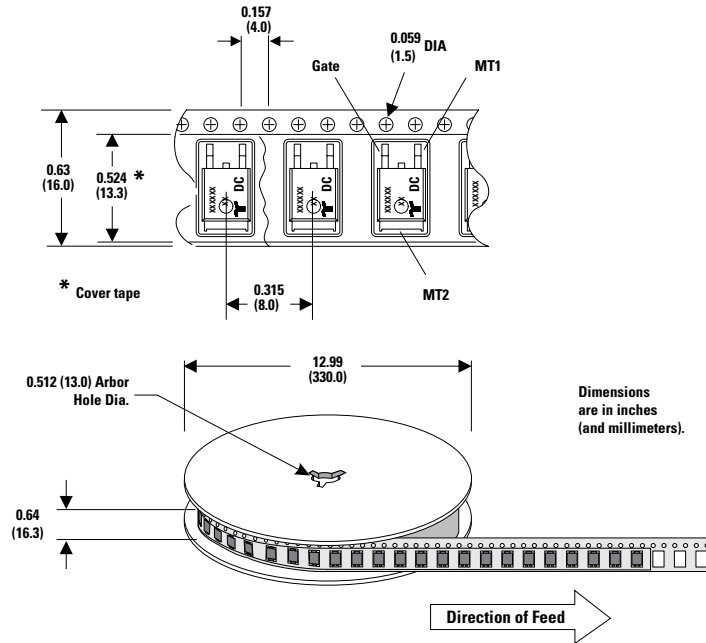

TO-263 Embossed Carrier Reel Pack (RP) Specifications

Meets all EIA-481-2 Standards

