

Lxx06xx & Qxx06xx & Qxx06xHx Series

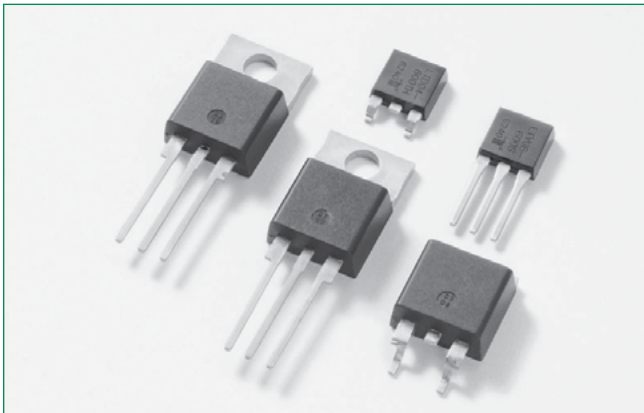

Description

This 6 Amp bidirectional solid state switch series is designed for AC switching and phase control applications such as motor speed and temperature modulation controls, lighting controls, and static switching relays.

Sensitive type components guarantee gate control in Quadrants I & IV as needed for digital control circuitry.

Standard type components normally operate in Quadrants I & III triggered from AC line.

Alternistor type components only operate in quadrants I, II, & III and are used in circuits requiring high dv/dt capability.

Agency Approval

Agency	Agency File Number
	E71639*

* - L Package Only

Main Features

Symbol	Value	Unit
$I_{T(RMS)}$	6	A
V_{DRM}/V_{RRM}	400, 600, 800 or 1000	V
$I_{GT(Q1)}$	5 to 50	mA

Features & Benefits

- RoHS-compliant
- Glass – passivated junctions
- Voltage capability up to 1000 V
- Surge capability up to 85 A
- The Lpackage has an isolation rating of 2500V_{RMS}
- Solid-state switching eliminates arcing or contact bounce that create voltage transients
- No contacts to wear out from reaction of switching events
- Restricted (or limited) RFI generation, depending on activation point of sine wave
- Only requires a short gate activation pulse during each half-cycle
- UL Recognized as an Electrically Isolated Semiconductor Device to UL 1557.

Schematic Symbol

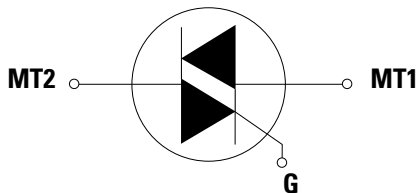

Applications

Excellent for AC switching and phase control applications such as heating, lighting, and motor speed controls.

Typical applications are AC solid-state switches, light dimmers, power tools, home/brown goods and white goods appliances.

Alternistor Triacs (no snubber required) are used in applications with extremely inductive loads requiring the highest commutation performance.

Internally constructed isolated packages are offered for ease of heat sinking with highest isolation voltage.

Additional Information



Datasheet



Resources



Samples

Absolute Maximum Ratings — Sensitive Triac (4 Quadrants)

Symbol	Parameter		Value	Unit	
$I_{T(RMS)}$	RMS on-state current (full sine wave)	Lxx06Ly/Lxx06Vy/Lxx06Dy Lxx06Ry/Lxx06Ny	$T_c = 80^\circ\text{C}$ $T_c = 85^\circ\text{C}$	6 A	
I_{TSM}	Non repetitive surge peak on-state current (full cycle, T_j initial = 25°C)	f = 50 Hz	t = 20 ms	50	A
		f = 60 Hz	t = 16.7 ms	60	
I^2t	I^2t Value for fusing	$t_p = 8.3$ ms		15	A^2s
di/dt	Critical rate of rise of on-state current $I_g = 50\text{mA}$ with 0.1 μs rise time	f = 120 Hz	$T_j = 110^\circ\text{C}$	70	$\text{A}/\mu\text{s}$
I_{GTM}	Peak gate trigger current	$t_p = 20\mu\text{s}$	$T_j = 110^\circ\text{C}$	4	A
$P_{G(AV)}$	Average gate power dissipation		$T_j = 110^\circ\text{C}$	0.4	W
T_{stg}	Storage temperature range			-40 to 150	$^\circ\text{C}$
T_j	Operating junction temperature range			-40 to 110	$^\circ\text{C}$

Note: xx = voltage/10, y = sensitivity

Absolute Maximum Ratings — Standard Triac

Symbol	Parameter		Value	Unit	
$I_{T(RMS)}$	RMS on-state current (full sine wave)	Qxx06Ry / Qxx06Ny	$T_c = 95^\circ\text{C}$	6	A
		Qxx06Ly	$T_c = 90^\circ\text{C}$		
I_{TSM}	Non repetitive surge peak on-state current (full cycle, T_j initial = 25°C)	f = 50 Hz	t = 20 ms	65	A
		f = 60 Hz	t = 16.7 ms	80	
I^2t	I^2t Value for fusing	$t_p = 8.3$ ms		26.5	A^2s
di/dt	Critical rate of rise of on-state current $I_g = 200\text{mA}$ with 0.1 μs rise time	f = 120 Hz	$T_j = 125^\circ\text{C}$	70	$\text{A}/\mu\text{s}$
I_{GTM}	Peak gate trigger current	$t_p = 20\mu\text{s}$	$T_j = 125^\circ\text{C}$	4	A
$P_{G(AV)}$	Average gate power dissipation		$T_j = 125^\circ\text{C}$	0.5	W
T_{stg}	Storage temperature range			-40 to 150	$^\circ\text{C}$
T_j	Operating junction temperature range			-40 to 125	$^\circ\text{C}$

Note: xx = voltage/10, y = sensitivity

Absolute Maximum Ratings — Alternistor Triac (3 Quadrants)

Symbol	Parameter		Value	Unit		
$I_{T(RMS)}$	RMS on-state current (full sine wave)	Qxx06LHy/Qxx06VHy/Qxx06DHy	$T_c = 95^\circ\text{C}$	6	A	
		Qxx06RHy/Qxx06NHy	$T_c = 100^\circ\text{C}$			
I_{TSM}	Non repetitive surge peak on-state current (full cycle, T_j initial = 25°C)	f = 50 Hz	t = 20 ms	Qxx06VHy Qxx06DHy	55	A
				Qxx06LHy Qxx06RHy Qxx06NHy	80	
		f = 60 Hz	t = 16.7 ms	Qxx06VHy Qxx06DHy	65	
				Qxx06LHy Qxx06RHy Qxx06NHy	85	
I^2t	I^2t Value for fusing	$t_p = 8.3$ ms		17.5	A^2s	
				30		
di/dt	Critical rate of rise of on-state current	f = 120 Hz	$T_j = 125^\circ\text{C}$	70	$\text{A}/\mu\text{s}$	
I_{GTM}	Peak gate trigger current	$t_p \leq 10 \mu\text{s}; I_{GT} \leq I_{GTM}$		$T_j = 125^\circ\text{C}$	1.6	A
$P_{G(AV)}$	Average gate power dissipation		$T_j = 125^\circ\text{C}$	0.5	W	
T_{stg}	Storage temperature range			-40 to 150	$^\circ\text{C}$	
T_j	Operating junction temperature range			-40 to 125	$^\circ\text{C}$	

Note: xx = voltage/10, y = sensitivity

Electrical Characteristics ($T_J = 25^\circ\text{C}$, unless otherwise specified) — Sensitive Triac (4 Quadrants)

Symbol	Test Conditions	Quadrant		Value			Unit
				Lxx06x5	Lxx06x6	Lxx06x8	
I_{GT}	$V_D = 12\text{V}$ $R_L = 60\ \Omega$	I – II – III IV	MAX.	5 5	5 10	10 20	mA
V_{GT}	$V_D = 12\text{V}$ $R_L = 60\ \Omega$	ALL	MAX.	1.3			V
V_{GD}	$V_D = V_{DRM}$ $R_L = 3.3\ \text{k}\Omega$ $T_J = 110^\circ\text{C}$	ALL	MIN.	0.2			V
I_H	$I_T = 100\text{mA}$		MAX.	10	10	20	mA
dv/dt	$V_D = V_{DRM}$ Gate Open $T_J = 100^\circ\text{C}$	400V 600V	TYP.	30 20	30 20	40 30	V/ μs
(dv/dt)c	(di/dt)c = 3.2 A/ms $T_J = 110^\circ\text{C}$		TYP.	1	2	2	V/ μs
t_{gt}	$I_G = 2 \times I_{GT}$ PW = 15 μs $I_T = 8.5\ \text{A(pk)}$		TYP.	3.0	3.0	3.2	μs

Electrical Characteristics ($T_J = 25^\circ\text{C}$, unless otherwise specified) — Standard Triac

Symbol	Test Conditions	Quadrant		Value		Unit
				Qxx06x4	Qxx06x5	
I_{GT}	$V_D = 12\text{V}$ $R_L = 60\ \Omega$	I – II – III IV	MAX. TYP.	25 50	50 75	mA
V_{GT}	$V_D = 12\text{V}$ $R_L = 60\ \Omega$	I – II – III	MAX.	1.3		V
V_{GD}	$V_D = V_{DRM}$ $R_L = 3.3\ \text{k}\Omega$ $T_J = 125^\circ\text{C}$	ALL	MIN.	0.2		V
I_H	$I_T = 200\text{mA}$		MAX.	50	50	mA
dv/dt	$V_D = V_{DRM}$ Gate Open $T_J = 125^\circ\text{C}$	400V 600V 800V	MIN.	120	100 85	V/ μs
	$V_D = V_{DRM}$ Gate Open $T_J = 100^\circ\text{C}$	1000V		100		
(dv/dt)c	(di/dt)c = 3.2 A/ms $T_J = 125^\circ\text{C}$		TYP.	4	4	V/ μs
t_{gt}	$I_G = 2 \times I_{GT}$ PW = 15 μs $I_T = 8.5\ \text{A(pk)}$		TYP.	3.0	3.0	μs

Electrical Characteristics ($T_J = 25^\circ\text{C}$, unless otherwise specified) — Alternistor Triac (3 Quadrants)

Symbol	Test Conditions	Quadrant		Value		Unit	
				Qxx06xH3	Qxx06xH4		
I_{GT}	$V_D = 12\text{V}$ $R_L = 60\ \Omega$	I – II – III	MAX.	10	35	mA	
V_{GT}	$V_D = 12\text{V}$ $R_L = 60\ \Omega$	I – II – III	MAX.	1.3		V	
V_{GD}	$V_D = V_{DRM}$ $R_L = 3.3\ \text{k}\Omega$ $T_J = 125^\circ\text{C}$	I – II – III	MIN.	0.2		V	
I_H	$I_T = 100\text{mA}$		MAX.	15	35	mA	
dv/dt	$V_D = V_{DRM}$ Gate Open $T_J = 125^\circ\text{C}$	Qxx06VHy / Qxx06DHy	MIN.	400V 600V 800V	75 50 200	400 300 200	
	$V_D = V_{DRM}$ Gate Open $T_J = 100^\circ\text{C}$	Qxx06LHy / Qxx06RHhy / Qxx06NHhy		400V 600V 800V	75 50	450 350 250	
		ALL		1000V		150	
(dv/dt)c	(di/dt)c = 3.2 A/ms $T_J = 125^\circ\text{C}$			MIN.	20	25	V/ μs
t_{gt}	$I_G = 2 \times I_{GT}$ PW = 15 μs $I_T = 8.5\ \text{A(pk)}$			TYP.	4.0	4.0	μs

Note: xx = voltage/10, x = package, y = sensitivity

Static Characteristics

Symbol	Test Conditions			Value	Unit		
V_{TM}	$I_{TM} = 11.3A$ $t_p = 380 \mu s$			MAX.	1.60 V		
I_{DRM} / I_{RRM}	$V_{DRM} = V_{RRM}$	Lxx06xy	$T_J = 25^\circ C$	400 - 600V	MAX.	20	μA
			$T_J = 110^\circ C$	400 - 600V		0.5	mA
		Qxx06xy	$T_J = 25^\circ C$	400 - 1000V		50	μA
			$T_J = 125^\circ C$	400 - 800V		2	mA
			$T_J = 100^\circ C$	1000V		3	
		Qxx06xHy	$T_J = 25^\circ C$	400 - 800V		10	μA
				1000V		20	
			$T_J = 125^\circ C$	400 - 800V		3	mA
		$T_J = 100^\circ C$	1000V	2			

Thermal Resistances

Symbol	Parameter	Value	Unit
$R_{\theta(J-C)}$	Junction to case (AC)	L/Qxx06Ryy / L/Qxx06Nyy	1.8
		L/Qxx06Ly	3.3
		L/Qxx06Vyy / L/Qxx06Dyy	3.2
$R_{\theta(J-A)}$	Junction to ambient	L/Qxx06Ryy	45
		L/Qxx06Ly	50
		L/Qxx06Vyy	70

Note: xx = voltage, x = package, y = sensitivity, yy = type & sensitivity

Figure 1: Definition of Quadrants

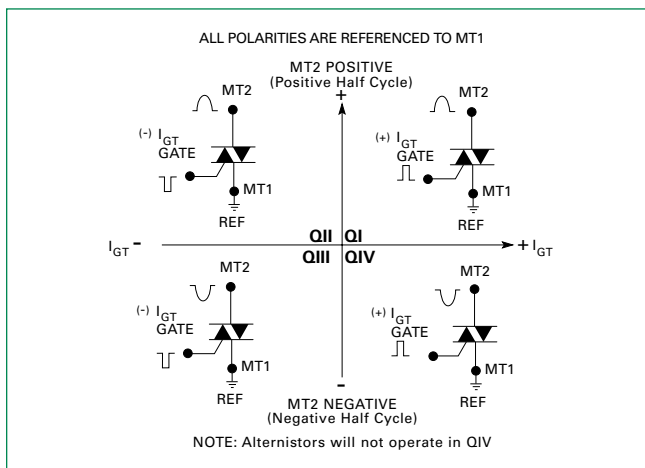

Note: Alternistors will not operate in QIV

Figure 2: Normalized DC Gate Trigger Current for All Quadrants vs. Junction Temperature

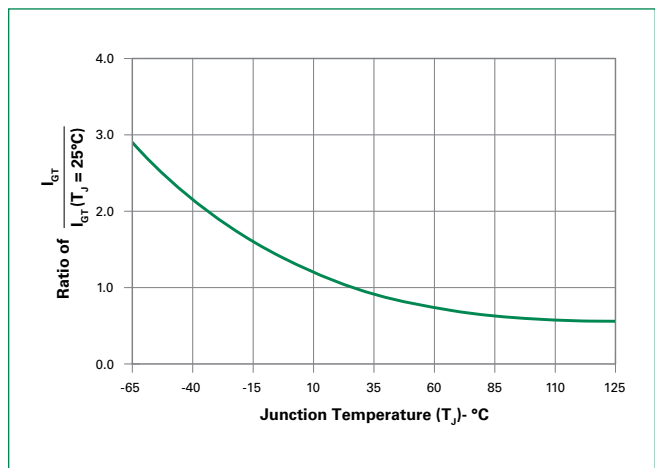

Figure 3: Normalized DC Holding Current vs. Junction Temperature

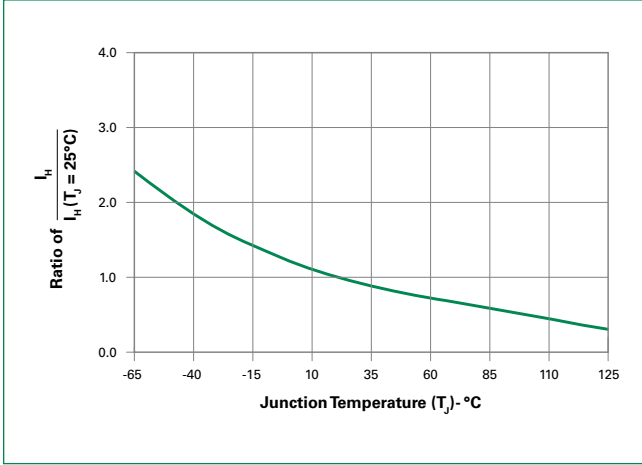

Figure 4: Normalized DC Gate Trigger Voltage for All Quadrants vs. Junction Temperature

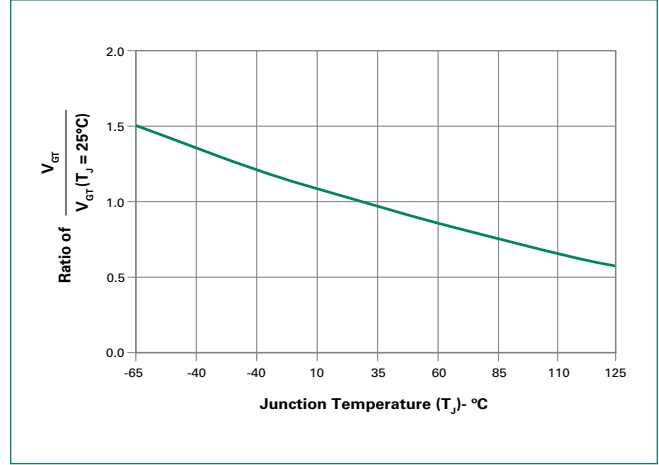

Figure 5: Power Dissipation (Typical) vs. RMS On-State Current

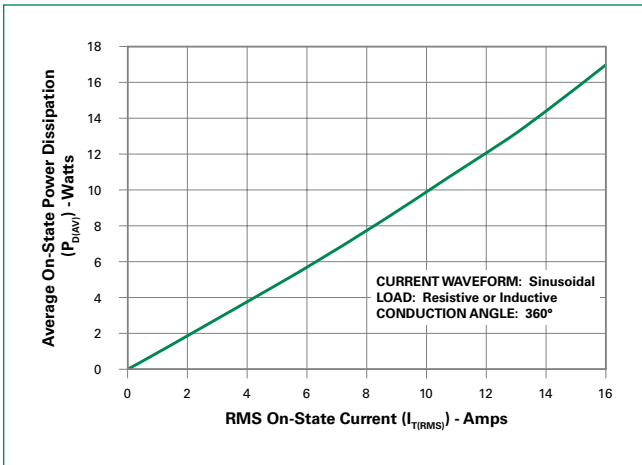

Figure 6: Maximum Allowable Case Temperature vs. On-State Current (Sensitive Triac)

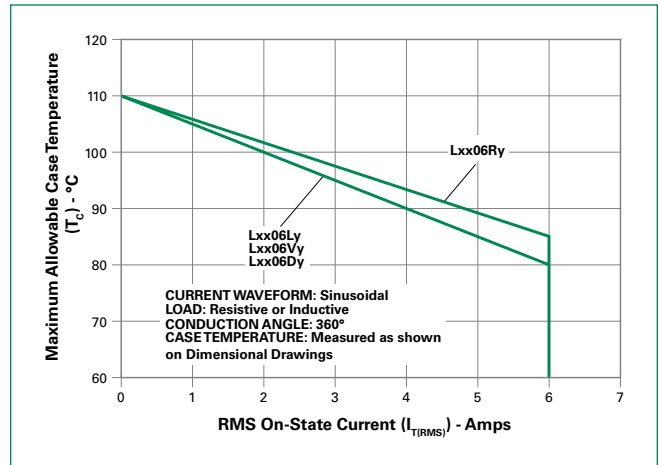

Figure 7: Maximum Allowable Case Temperature vs. On-State Current (Standard Triac)

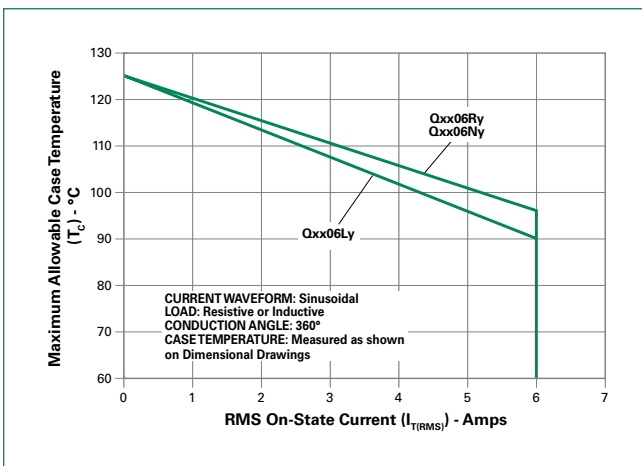

Figure 8: Maximum Allowable Case Temperature vs. On-State Current (Alternistor Triac)

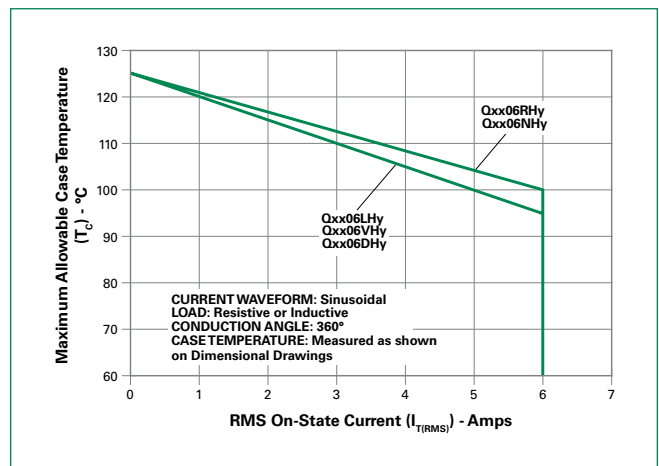

Figure 9: Maximum Allowable Ambient Temperature vs. On-State Current (Sensitive / Standard Triac)

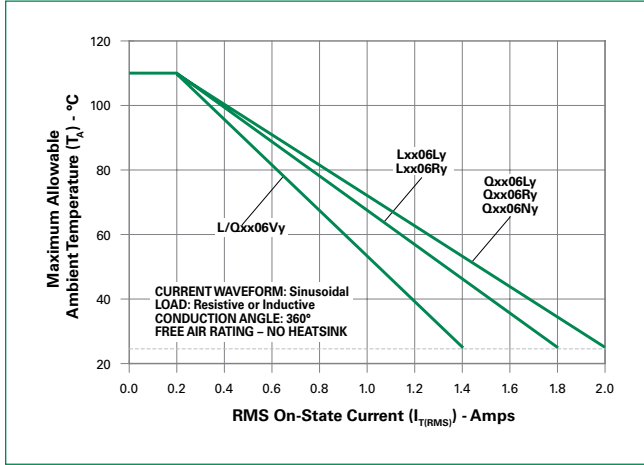

Figure 10: Maximum Allowable Ambient Temperature vs. On-State Current (Alternistor Triac)

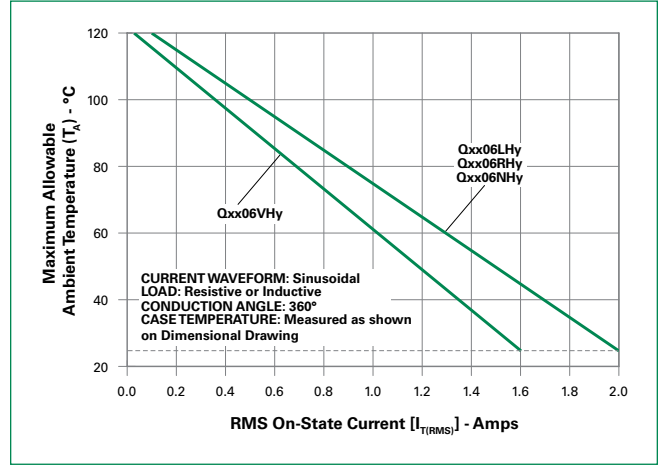

Figure 11: On-State Current vs. On-State Voltage (Typical)

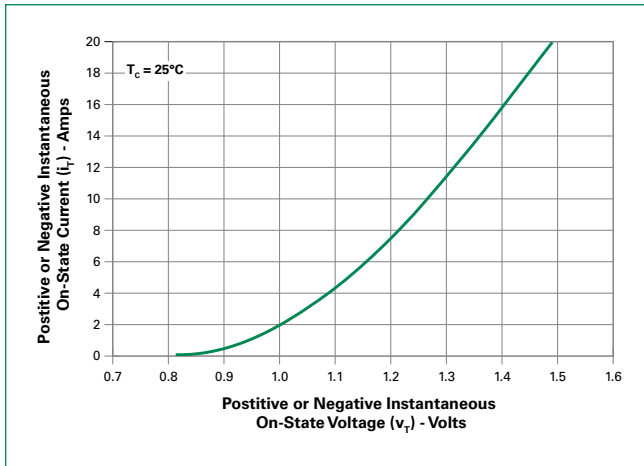

Figure 12: Surge Peak On-State Current vs. Number of Cycles (Sensitive / Standard Triac)

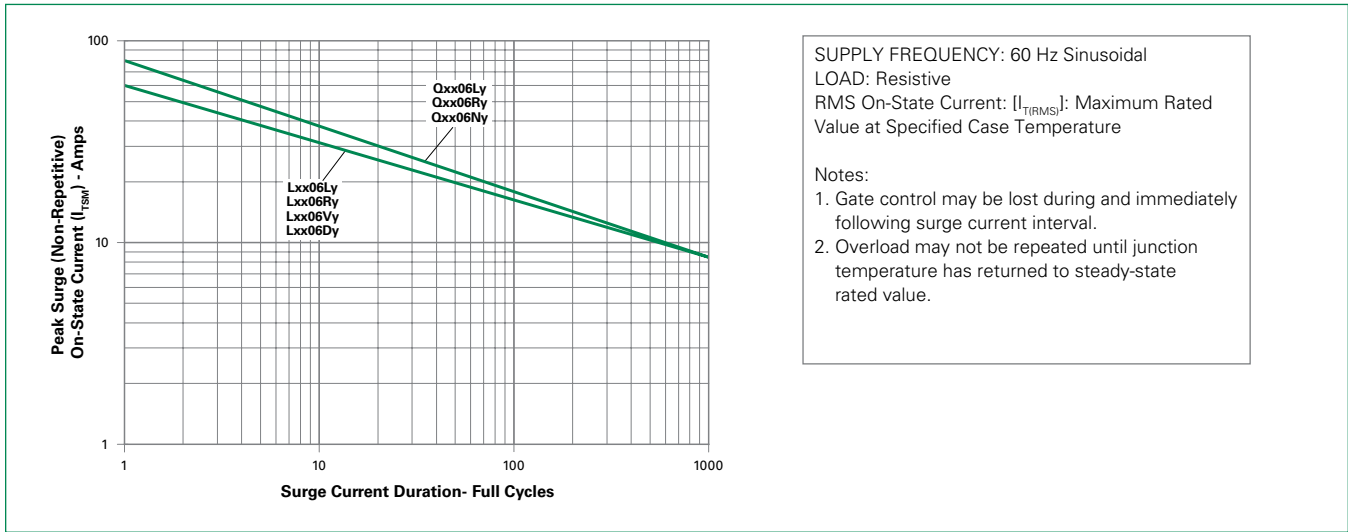
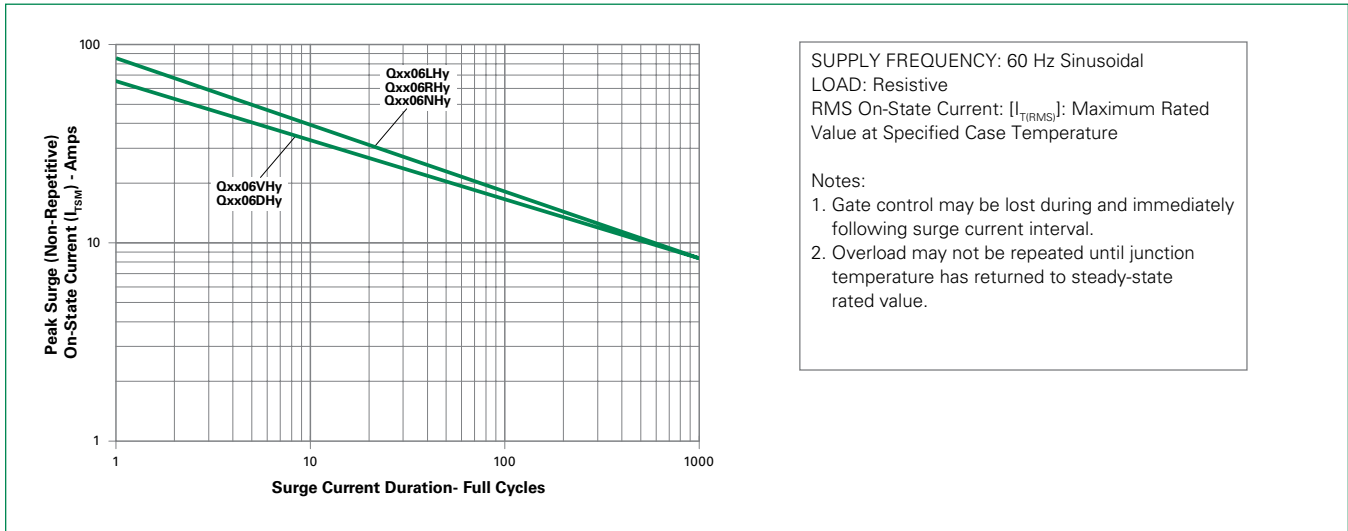

Figure 13: Surge Peak On-State Current vs. Number of Cycles (Alternistor Triac)



Note: xx = voltage/10, x = package, y = sensitivity,

Soldering Parameters

Reflow Condition		Pb – Free assembly
Pre Heat	- Temperature Min ($T_{s(min)}$)	150°C
	- Temperature Max ($T_{s(max)}$)	200°C
	- Time (min to max) (t_s)	60 – 120 secs
Average ramp up rate (Liquidus Temp) (T_L) to peak		3°C/second max
$T_{s(max)}$ to T_L - Ramp-up Rate		3°C/second max
Reflow	- Temperature (T_L) (Liquidus)	217°C
	- Temperature (t_L)	60 – 150 seconds
Peak Temperature (T_p)		260 ^{+0/-5} °C
Time within 5°C of actual peak Temperature (t_p)		30 seconds
Ramp-down Rate		6°C/second max
Time 25°C to peak Temperature (T_p)		8 minutes Max.
Do not exceed		280°C

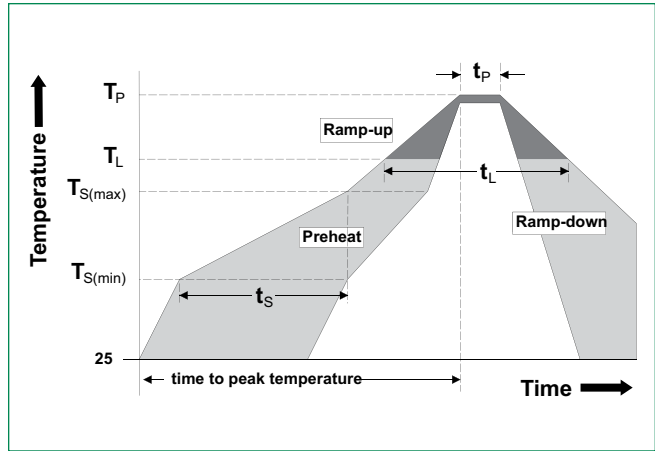

Physical Specifications

Terminal Finish	100% Matte Tin-plated
Body Material	UL Recognized compound meeting flammability rating V-0
Terminal Material	Copper Alloy

Design Considerations

Careful selection of the correct components for the application's operating parameters and environment will go a long way toward extending the operating life of the Thyristor. Good design practice should limit the maximum continuous current through the main terminals to 75% of the components rating. Other ways to ensure long life for a power discrete semiconductor are proper heat sinking and selection of voltage ratings for worst case conditions. Overheating, overvoltage (including dv/dt), and surge currents are the main killers of semiconductors. Correct mounting, soldering, and forming of the leads also help protect against component damage.

Environmental Specifications

Test	Specifications and Conditions
AC Blocking (V_{DRM})	MIL-STD-750, M-1040, Cond A Applied Peak AC voltage @ 125°C for 1008 hours
Temperature Cycling	MIL-STD-750, M-1051, 100 cycles; -40°C to +150°C; 15-min dwell-time
Temperature/Humidity	EIA / JEDEC, JESD22-A101 1008 hours; 320V - DC: 85°C; 85% rel humidity
High Temp Storage	MIL-STD-750, M-1031, 1008 hours; 150°C
Low-Temp Storage	1008 hours; -40°C
Resistance to Solder Heat	MIL-STD-750 Method 2031
Solderability	ANSI/J-STD-002, category 3, Test A
Lead Bend	MIL-STD-750, M-2036 Cond E

Dimensions — TO-220AB (R-Package) — Non-Isolated Mounting Tab Common with Center Lead

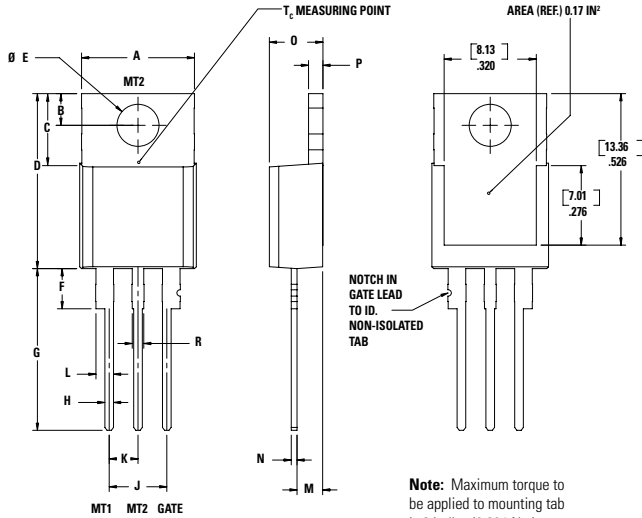

Dimension	Inches		Millimeters	
	Min	Max	Min	Max
A	0.380	0.420	9.65	10.67
B	0.105	0.115	2.67	2.92
C	0.230	0.250	5.84	6.35
D	0.590	0.620	14.99	15.75
E	0.142	0.147	3.61	3.73
F	0.110	0.130	2.79	3.30
G	0.540	0.575	13.72	14.61
H	0.025	0.035	0.64	0.89
J	0.195	0.205	4.95	5.21
K	0.095	0.105	2.41	2.67
L	0.060	0.075	1.52	1.91
M	0.085	0.095	2.16	2.41
N	0.018	0.024	0.46	0.61
O	0.178	0.188	4.52	4.78
P	0.045	0.060	1.14	1.52
R	0.038	0.048	0.97	1.22

Dimensions — TO-220AB (L-Package) — Isolated Mounting Tab

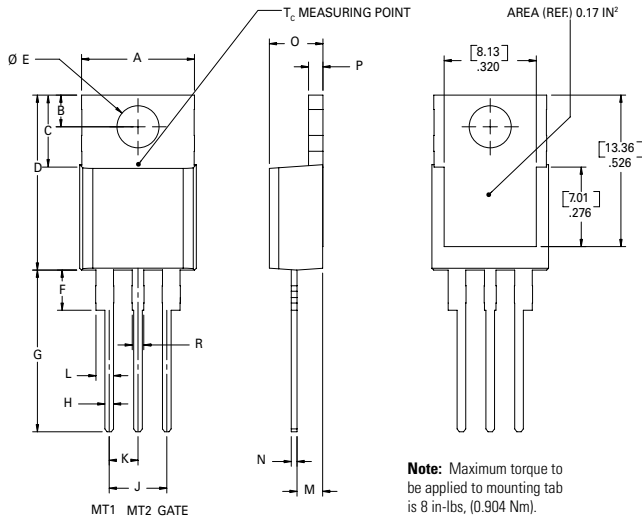

Dimension	Inches		Millimeters	
	Min	Max	Min	Max
A	0.380	0.420	9.65	10.67
B	0.105	0.115	2.67	2.92
C	0.230	0.250	5.84	6.35
D	0.590	0.620	14.99	15.75
E	0.142	0.147	3.61	3.73
F	0.110	0.130	2.79	3.30
G	0.540	0.575	13.72	14.61
H	0.025	0.035	0.64	0.89
J	0.195	0.205	4.95	5.21
K	0.095	0.105	2.41	2.67
L	0.060	0.075	1.52	1.91
M	0.085	0.095	2.16	2.41
N	0.018	0.024	0.46	0.61
O	0.178	0.188	4.52	4.78
P	0.045	0.060	1.14	1.52
R	0.038	0.048	0.97	1.22

Dimensions – TO-263AB (N-Package) – D²-PAK Surface Mount

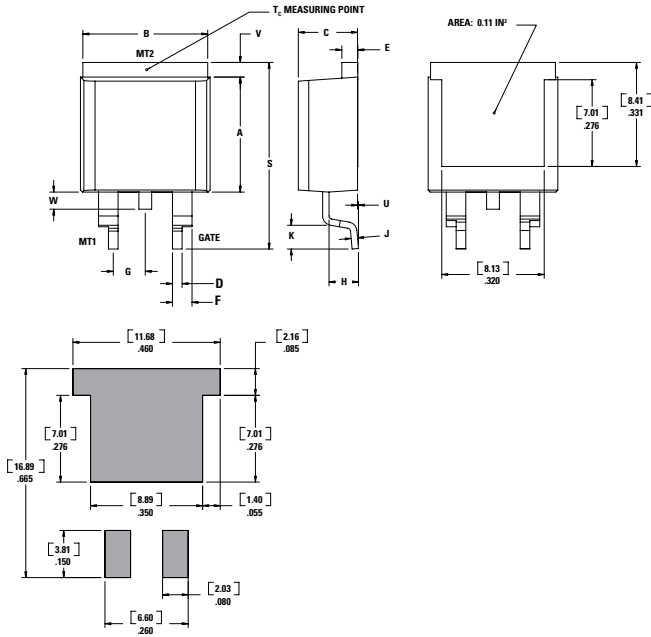

Dimension	Inches		Millimeters	
	Min	Max	Min	Max
A	0.360	0.370	9.14	9.40
B	0.380	0.420	9.65	10.67
C	0.178	0.188	4.52	4.78
D	0.025	0.035	0.64	0.89
E	0.045	0.060	1.14	1.52
F	0.060	0.075	1.52	1.91
G	0.095	0.105	2.41	2.67
H	0.092	0.102	2.34	2.59
J	0.018	0.024	0.46	0.61
K	0.090	0.110	2.29	2.79
S	0.590	0.625	14.99	15.88
V	0.035	0.045	0.89	1.14
U	0.002	0.010	0.05	0.25
W	0.040	0.070	1.02	1.78

Dimensions – TO-251AA (V-Package) – V-PAK Through Hole

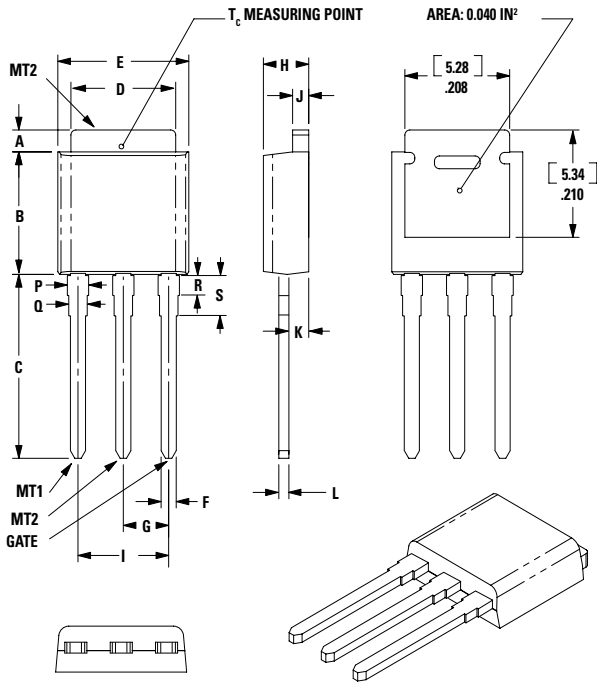

Dimension	Inches			Millimeters		
	Min	Typ	Max	Min	Typ	Max
A	0.037	0.040	0.043	0.94	1.01	1.09
B	0.235	0.242	0.245	5.97	6.15	6.22
C	0.350	0.361	0.375	8.89	9.18	9.53
D	0.205	0.208	0.213	5.21	5.29	5.41
E	0.255	0.262	0.265	6.48	6.66	6.73
F	0.027	0.031	0.033	0.69	0.80	0.84
G	0.087	0.090	0.093	2.21	2.28	2.36
H	0.085	0.092	0.095	2.16	2.34	2.41
I	0.176	0.180	0.184	4.47	4.57	4.67
J	0.018	0.020	0.023	0.46	0.51	0.58
K	0.035	0.037	0.039	0.90	0.95	1.00
L	0.018	0.020	0.023	0.46	0.52	0.58
P	0.042	0.047	0.052	1.06	1.20	1.32
Q	0.034	0.039	0.044	0.86	1.00	1.11
R	0.034	0.039	0.044	0.86	1.00	1.11
S	0.074	0.079	0.084	1.86	2.00	2.11

Dimensions — TO-252AA (D-Package) — D-PAK Surface mount

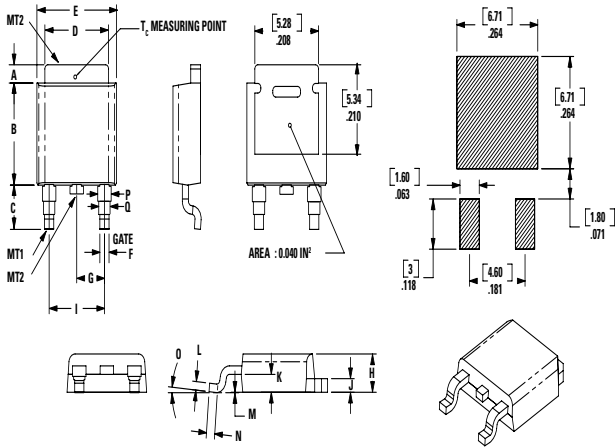

Dimension	Inches			Millimeters		
	Min	Typ	Max	Min	Typ	Max
A	0.037	0.040	0.043	0.94	1.01	1.09
B	0.235	0.243	0.245	5.97	6.16	6.22
C	0.106	0.108	0.113	2.69	2.74	2.87
D	0.205	0.208	0.213	5.21	5.29	5.41
E	0.255	0.262	0.265	6.48	6.65	6.73
F	0.027	0.031	0.033	0.69	0.80	0.84
G	0.087	0.090	0.093	2.21	2.28	2.36
H	0.085	0.092	0.095	2.16	2.33	2.41
I	0.176	0.179	0.184	4.47	4.55	4.67
J	0.018	0.020	0.023	0.46	0.51	0.58
K	0.035	0.037	0.039	0.90	0.95	1.00
L	0.018	0.020	0.023	0.46	0.51	0.58
M	0.000	0.000	0.004	0.00	0.00	0.10
N	0.021	0.026	0.027	0.53	0.67	0.69
O	0°	0°	5°	0°	0°	5°
P	0.042	0.047	0.052	1.06	1.20	1.32
Q	0.034	0.039	0.044	0.86	1.00	1.11

Product Selector

Part Number	Voltage				Gate Sensitivity Quadrants		Type	Package
	400V	600V	800V	1000V	I - II - III	IV		
Lxx06L5	X	X	-	-	5 mA	5 mA	Sensitive Triac	TO-220L
Lxx06D5	X	X	-	-	5 mA	5 mA	Sensitive Triac	TO-252 D-PAK
Lxx06R5	X	X	-	-	5mA	5mA	Sensitive Triac	TO-220R
Lxx06V5	X	X	-	-	5 mA	5 mA	Sensitive Triac	TO-251 V-PAK
Lxx06L6	X	X	-	-	5 mA	10 mA	Sensitive Triac	TO-220L
Lxx06D6	X	X	-	-	5 mA	10 mA	Sensitive Triac	TO-252 D-PAK
Lxx06R6	X	X	-	-	5mA	10mA	Sensitive Triac	TO-220R
Lxx06V6	X	X	-	-	5 mA	10 mA	Sensitive Triac	TO-251 V-PAK
Lxx06L8	X	X	-	-	10 mA	20 mA	Sensitive Triac	TO-220L
Lxx06D8	X	X	-	-	10 mA	20 mA	Sensitive Triac	TO-252 D-PAK
Lxx06R8	X	X	-	-	10mA	20mA	Sensitive Triac	TO-220R
Lxx06V8	X	X	-	-	10 mA	20 mA	Sensitive Triac	TO-251 V-PAK
Qxx06VH3	X	X	-	-	10 mA	-	Alternistor Triac	TO-251 V-PAK
Qxx06DH3	X	X	-	-	10 mA	-	Alternistor Triac	TO-252 D-PAK
Qxx06L4	X	-	-	-	25 mA	-	Standard Triac	TO-220L
Qxx06R4	X	-	-	-	25 mA	-	Standard Triac	TO-220R
Qxx06N4	X	-	-	-	25 mA	-	Standard Triac	TO-263 D ² -PAK
Qxx06LH3	X	X	-	-	10mA	-	Alternistor Triac	TO-220L
Qxx06RH3	X	X	-	-	10mA	-	Alternistor Triac	TO-220R
Qxx06LH4	X	X	X	X	35 mA	-	Alternistor Triac	TO-220L
Qxx06RH4	X	X	X	X	35 mA	-	Alternistor Triac	TO-220R
Qxx06VH4	X	X	X	X	35 mA	-	Alternistor Triac	TO-251 V-PAK
Qxx06DH4	X	X	X	X	35 mA	-	Alternistor Triac	TO-252 D-PAK
Qxx06NH4	X	X	X	X	35 mA	-	Alternistor Triac	TO-263 D ² -PAK
Qxx06L5	-	X	X	X	50 mA	-	Standard Triac	TO-220L
Qxx06R5	-	X	X	X	50 mA	-	Standard Triac	TO-220R
Qxx06N5	-	X	X	X	50 mA	-	Standard Triac	TO-263 D ² -PAK

Packing Options

Part Number	Marking	Weight	Packing Mode	Base Quantity
Lxx06L/RyTP	Lxx06L/Ry	2.2 g	Tube Pack	1000 (50 per tube)
Lxx06DyTP	Lxx06Dy	0.3 g	Tube	750 (75 per tube)
Lxx06DyRP	Lxx06Dy	0.3 g	Embossed Carrier	2500
Lxx06VyTP	Lxx06Vy	0.4 g	Tube	750 (75 per tube)
Qxx06L/RyyTP	Qxx06L/Ryy	2.2 g	Tube Pack	1000 (50 per tube)
Qxx06NyyTP	Qxx06Nyy	1.6 g	Tube	1000 (50 per tube)
Qxx06NyyRP	Qxx06Nyy	1.6 g	Embossed Carrier	500
Qxx06DyyTP	Qxx06Dyy	0.3 g	Tube	750 (75 per tube)
Qxx06DyyRP	Qxx06Dyy	0.3 g	Embossed Carrier	2500
Qxx06VyyTP	Qxx06Vyy	0.4 g	Tube	750 (75 per tube)

Note: xx = voltage/10; yy = sensitivity

TO-252 Embossed Carrier Reel Pack (RP) Specifications

Meets all EIA-481-2 Standards

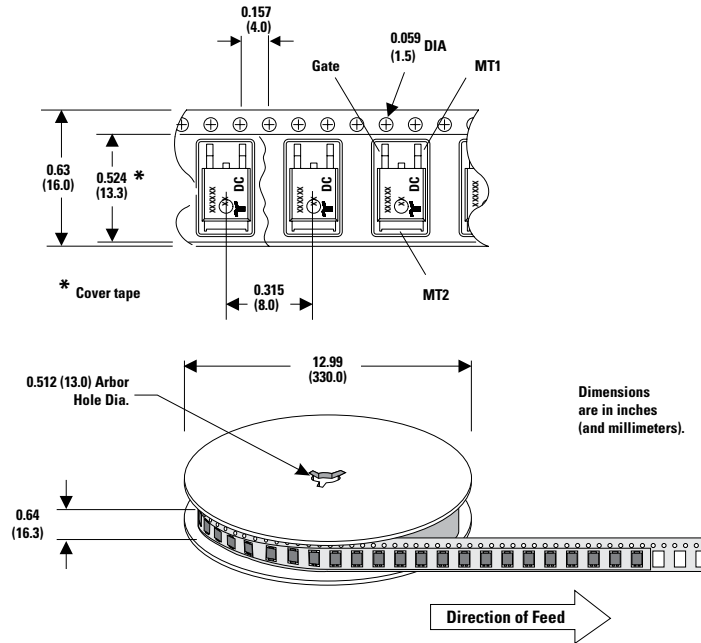

TO-263 Embossed Carrier Reel Pack (RP) Specifications

Meets all EIA-481-2 Standards

