

Qxx15xx & Qxx16xHx Series

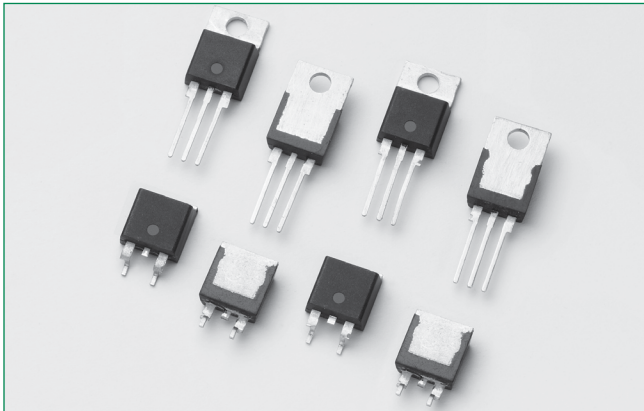

Agency Approval

Agency	Agency File Number
	E71639*

* - L Package only

Main Features

Symbol	Value	Unit
$I_{T(RMS)}$	15 or 16	A
V_{DRM}/V_{RRM}	400, 600, 800 or 1000	V
$I_{GT(Q1)}$	10, 20, 35, 50 or 80	mA

Schematic Symbol

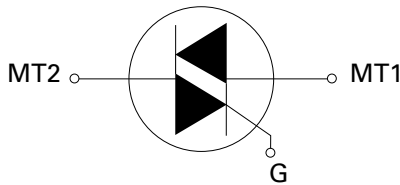

Additional Information



Datasheet



Resources



Samples

Description

This 15 Amp and 16 Amp bi-directional solid state switch series is designed for AC switching and phase control applications such as motor speed, temperature modulation controls, lighting controls, and static switching relays.

Standard type devices normally operate in Quadrants I & III triggered from AC line.

Standard alternistor triac components operate with in-phase signals in Quadrants I or III and ONLY unipolar negative gate pulses for Quadrant II or III. The alternistor triac will not operate in Quadrant IV. These are used in circuit applications requiring a high dv/dt capability.

Features & Benefits

- RoHS-compliant
- Glass – passivated junctions
- Voltage capability up to 1000 V
- Surge capability up to 200 A
- The L-package has an isolation rating of 2500V_{RMS}
- Solid-state switching eliminates arcing or contact bounce that create voltage transients
- No contacts to wear out from reaction of switching events
- Restricted (or limited) RFI generation, depending on activation point in sine wave
- Requires only a small gate activation pulse in each half-cycle

Applications

Excellent for AC switching and phase control applications such as heating, lighting, and motor speed controls.

Typical applications are AC solid-state switches, light dimmers, power tools, lawn care equipment, home/brown goods and white goods appliances.

Alternistor Triacs (no snubber required) are used in applications with extremely inductive loads requiring highest commutation performance.

Internally constructed isolated packages are offered for ease of heat sinking with highest isolation voltage.

Absolute Maximum Ratings — Standard Triac

Symbol	Parameter			Value	Unit
$I_{T(RMS)}$	RMS on-state current (full sine wave)	Qxx15Ly	$T_c = 80^\circ\text{C}$	15	A
		Qxx15Ry Qxx15Ny	$T_c = 90^\circ\text{C}$		
I_{TSM}	Non repetitive surge peak on-state current (full cycle, T_j initial = 25°C)	f = 50 Hz	t = 20 ms	167	A
		f = 60 Hz	t = 16.7 ms	200	
I^2t	I^2t Value for fusing	-	$t_p = 8.3$ ms	166	A ² s
di/dt	Critical rate of rise of on-state current	f = 120 Hz	$T_j = 125^\circ\text{C}$	100	A/ μs
I_{GTM}	Peak gate trigger current	$t_p = 20\mu\text{s}$	$T_j = 125^\circ\text{C}$	4	A
$P_{G(AV)}$	Average gate power dissipation		$T_j = 125^\circ\text{C}$	0.5	W
T_{stg}	Storage temperature range		-	-40 to 150	$^\circ\text{C}$
T_j	Operating junction temperature range		-	-40 to 125	$^\circ\text{C}$

Note: xx = voltage/10, γ = sensitivity

Absolute Maximum Ratings — Alternistor Triac (3 Quadrants)

Symbol	Parameter			Value	Unit
$I_{T(RMS)}$	RMS on-state current (full sine wave)	Qxx16LHy	$T_c = 80^\circ\text{C}$	16	A
		Qxx16RHy Qxx16NHy	$T_c = 90^\circ\text{C}$		
I_{TSM}	Non repetitive surge peak on-state current (full cycle, T_j initial = 25°C)	f = 50 Hz	t = 20 ms	167	A
		f = 60 Hz	t = 16.7 ms	200	
I^2t	I^2t Value for fusing		$t_p = 8.3$ ms	166	A ² s
di/dt	Critical rate of rise of on-state current	f = 120 Hz	$T_j = 125^\circ\text{C}$	100	A/ μs
I_{GTM}	Peak gate trigger current	$t_p = 20\mu\text{s}$	$T_j = 125^\circ\text{C}$	4	A
$P_{G(AV)}$	Average gate power dissipation		$T_j = 125^\circ\text{C}$	0.5	W
T_{stg}	Storage temperature range			-40 to 150	$^\circ\text{C}$
T_j	Operating junction temperature range			-40 to 125	$^\circ\text{C}$

Note: xx = voltage/10, γ = sensitivity

Electrical Characteristics ($T_j = 25^\circ\text{C}$, unless otherwise specified) — Standard Triac

Symbol	Test Conditions	Quadrant		Value	Unit
I_{GT}	$V_D = 12\text{V}$ $R_L = 60\ \Omega$	I – II – III	MAX.	50	mA
V_{GT}	$V_D = 12\text{V}$ $R_L = 60\ \Omega$	I – II – III	MAX.	2.0	V
V_{GD}	$V_D = V_{DRM}$ $R_L = 3.3\ \text{k}\Omega$ $T_j = 125^\circ\text{C}$	I – II – III	MIN.	0.2	V
I_H	$I_T = 100\text{mA}$		MAX.	70	mA
dv/dt	$V_D = V_{DRM}$ Gate Open $T_j = 125^\circ\text{C}$	400V	MIN.	275	V/ μs
		600V		225	
		800V		200	
	$V_D = V_{DRM}$ Gate Open $T_j = 100^\circ\text{C}$	1000V		200	
(dv/dt)c	(di/dt)c = 8.1 A/ms $T_j = 125^\circ\text{C}$		MIN.	4	V/ μs
t_{gt}	$I_G = 2 \times I_{GT}$ PW = 15 μs $I_T = 22.6$ A(pk)		TYP.	4	μs

Electrical Characteristics ($T_J = 25^\circ\text{C}$, unless otherwise specified) — Alternistor Triac (3 Quadrants)

Symbol	Test Conditions	Quadrant	Qxx16xH2	Qxx16xH3	Qxx16xH4	Qxx16xH6	Unit	
I_{GT}	$V_D = 12V$ $R_L = 60\ \Omega$	I – II – III	MAX.	10	20	35	80	mA
V_{GT}	$V_D = 12V$ $R_L = 60\ \Omega$	I – II – III	MAX.	1.3			V	
V_{GD}	$V_D = V_{DRM}$ $R_L = 3.3\ k\Omega$ $T_J = 125^\circ\text{C}$	I – II – III	MIN.	0.2			V	
I_H	$I_T = 100\text{mA}$		MAX.	15	35	50	70	mA
dv/dt	$V_D = V_{DRM}$ Gate Open $T_J = 125^\circ\text{C}$	400V	MIN.	200	350	475	925	V/ μs
		600V		150	250	400	850	
		800V		100	200	350	475	
	$V_D = V_{DRM}$ Gate Open $T_J = 100^\circ\text{C}$	1000V		100	200	300	350	
(dv/dt)c	(di/dt)c = 8.6 A/ms $T_J = 125^\circ\text{C}$		MIN.	2	20	25	30	V/ μs
t_{gt}	$I_G = 2 \times I_{GT}$ PW = 15 μs $I_T = 22.6\ \text{A(pk)}$		TYP.	3	3	3	5	μs

Static Characteristics

Symbol	Test Conditions	Value	Unit			
V_{TM}	15A Device $I_T = 21.2\text{A}$ $t_p = 380\ \mu\text{s}$	MAX	1.60			
	16A Device $I_T = 22.6\text{A}$ $t_p = 380\ \mu\text{s}$					
I_{DRM} I_{RRM}	$V_D = V_{DRM} / V_{RRM}$	$T_J = 25^\circ\text{C}$	400-1000V	MAX	5	μA
		$T_J = 125^\circ\text{C}$	400-800V		2	mA
		$T_J = 100^\circ\text{C}$	1000V		3	

Thermal Resistances

Symbol	Parameter	Value	Unit	
$R_{\Theta(J-C)}$	Junction to case (AC)	Qxx15Ry Qxx15Ny Qxx16RHr Qxx16NHr	1.7	$^\circ\text{C/W}$
		Qxx15Ly Qxx16LHy	2.1	
$R_{\Theta(J-A)}$	Junction to ambient	Qxx15Ry Qxx16RHr	45	$^\circ\text{C/W}$
		Qxx15Ly Qxx16LHy	50	

Note: xx = voltage/10; y = sensitivity

Figure 1: Definition of Quadrants



Note: Alternistors will not operate in QIV

Figure 2: Normalized DC Gate Trigger Current for All Quadrants vs. Junction Temperature



Figure 3: Normalized DC Holding Current vs. Junction Temperature

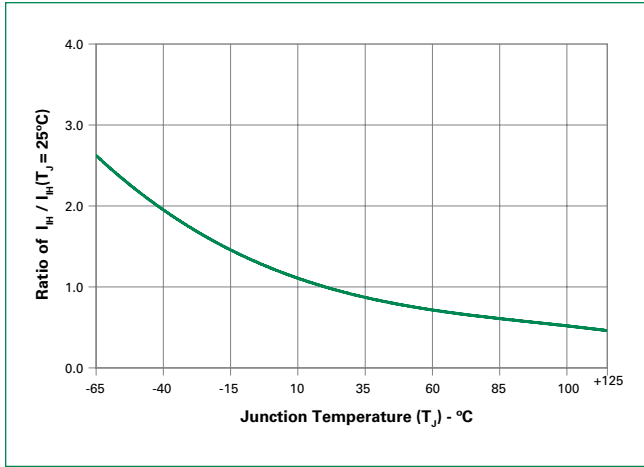

Figure 4: Normalized DC Gate Trigger Voltage for All Quadrants vs. Junction Temperature

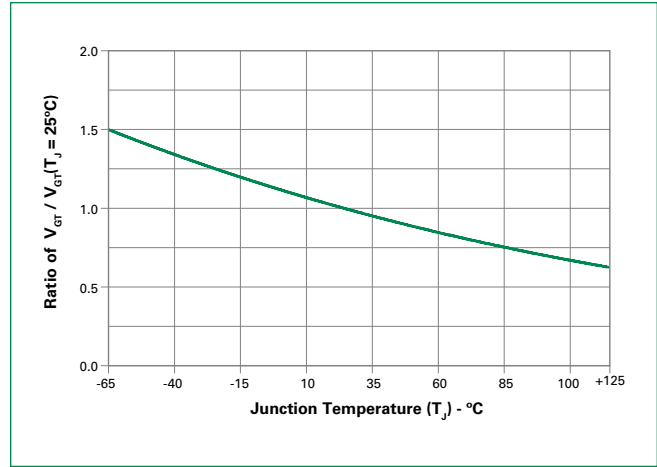

Figure 5: Power Dissipation (Typical) vs. RMS On-State Current

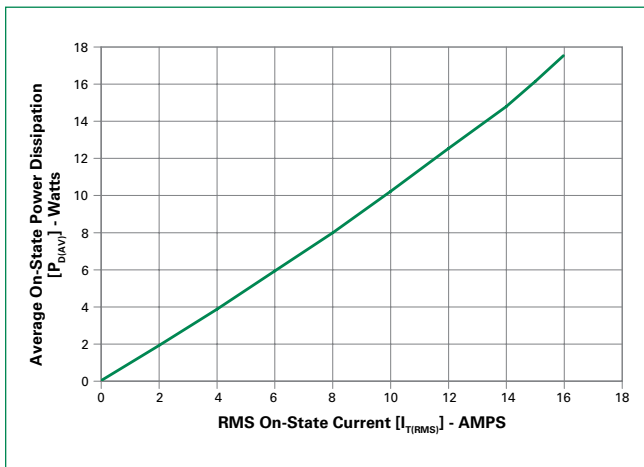

Figure 6: Maximum Allowable Case Temperature vs. On-State Current (15A devices)

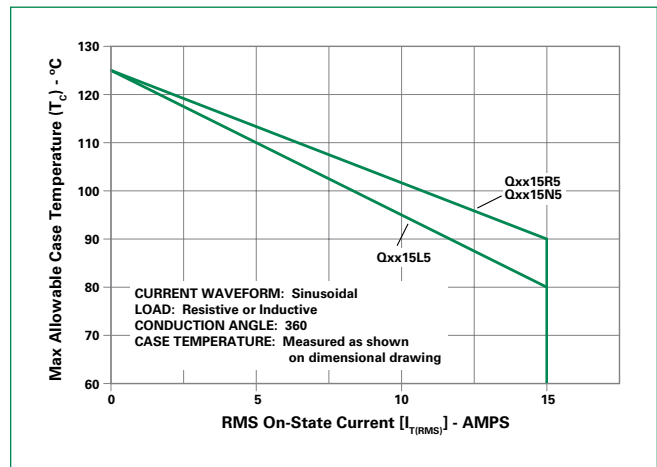

Figure 7: Maximum Allowable Case Temperature vs. On-State Current (16A devices)

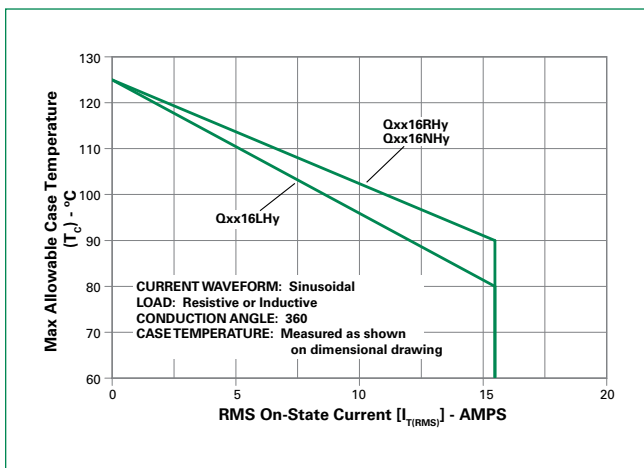

Figure 8: Maximum Allowable Ambient Temperature vs. On-State Current

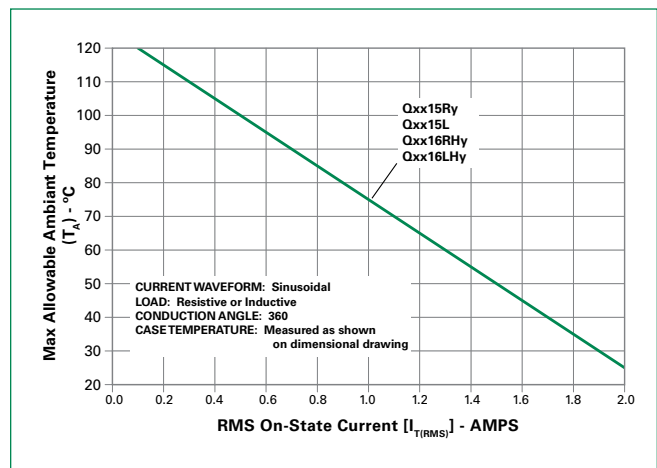

Figure 9: On-State Current vs. On-State Voltage (Typical)

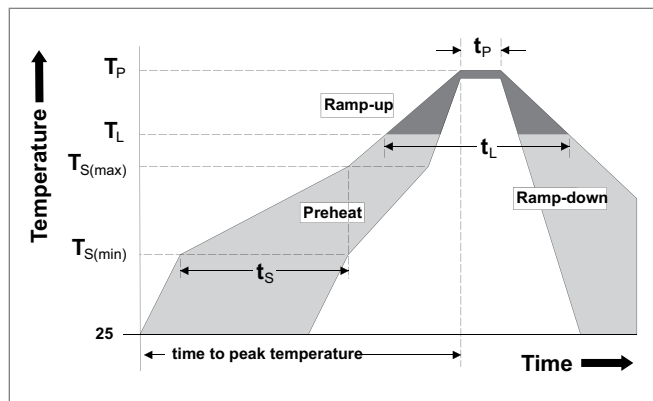

Figure 10: Surge Peak On-State Current vs. Number of Cycles



Soldering Parameters

Reflow Condition		Pb – Free assembly
Pre Heat	- Temperature Min ($T_{s(min)}$)	150°C
	- Temperature Max ($T_{s(max)}$)	200°C
	- Time (min to max) (t_s)	60 – 180 secs
Average ramp up rate (Liquidus Temp) (T_L) to peak		5°C/second max
$T_{s(max)}$ to T_L - Ramp-up Rate		5°C/second max
Reflow	- Temperature (T_L) (Liquidus)	217°C
	- Temperature (t_L)	60 – 150 seconds
Peak Temperature (T_p)		260 ^{+0/-5} °C
Time within 5°C of actual peak Temperature (t_p)		20 – 40 seconds
Ramp-down Rate		5°C/second max
Time 25°C to peak Temperature (T_p)		8 minutes Max.
Do not exceed		280°C



Physical Specifications

Terminal Finish	100% Matte Tin-plated
Body Material	UL Recognized compound meeting flammability rating V-0
Terminal Material	Copper Alloy

Design Considerations

Careful selection of the correct device for the application's operating parameters and environment will go a long way toward extending the operating life of the Thyristor. Good design practice should limit the maximum continuous current through the main terminals to 75% of the device rating. Other ways to ensure long life for a power discrete semiconductor are proper heat sinking and selection of voltage ratings for worst case conditions. Overheating, overvoltage (including dv/dt), and surge currents are the main killers of semiconductors. Correct mounting, soldering, and forming of the leads also help protect against component damage.

Environmental Specifications

Test	Specifications and Conditions
AC Blocking	MIL-STD-750, M-1040, Cond A Applied Peak AC voltage @ 125°C for 1008 hours
Temperature Cycling	MIL-STD-750, M-1051, 100 cycles; -40°C to +150°C; 15-min dwell time
Temperature/Humidity	EIA / JEDEC, JESD22-A101 1008 hours; 320V - DC; 85°C; 85% rel humidity
High Temp Storage	MIL-STD-750, M-1031, 1008 hours; 150°C
Low-Temp Storage	1008 hours; -40°C
Resistance to Solder Heat	MIL-STD-750 Method 2031
Solderability	ANSI/J-STD-002, category 3, Test A
Lead Bend	MIL-STD-750, M-2036 Cond E

Dimensions — TO-220AB (R-Package) — Non-Isolated Mounting Tab Common with Center Lead



Dimension	Inches		Millimeters	
	Min	Max	Min	Max
A	0.380	0.420	9.65	10.67
B	0.105	0.115	2.66	2.92
C	0.230	0.250	5.84	6.35
D	0.590	0.620	14.99	15.75
E	0.142	0.147	3.61	3.73
F	0.110	0.130	2.79	3.30
G	0.540	0.575	13.72	14.61
H	0.025	0.035	0.64	0.89
J	0.195	0.205	4.95	5.21
K	0.095	0.105	2.41	2.67
L	0.060	0.075	1.52	1.91
M	0.085	0.095	2.16	2.41
N	0.018	0.024	0.46	0.61
O	0.178	0.188	4.52	4.78
P	0.045	0.060	1.14	1.52
R	0.038	0.048	0.97	1.22

Dimensions — TO-220AB (L-Package) — Isolated Mounting Tab



Dimension	Inches		Millimeters	
	Min	Max	Min	Max
A	0.380	0.420	9.65	10.67
B	0.105	0.115	2.67	2.92
C	0.230	0.250	5.84	6.35
D	0.590	0.620	14.99	15.75
E	0.142	0.147	3.61	3.73
F	0.110	0.130	2.79	3.30
G	0.540	0.575	13.72	14.60
H	0.025	0.035	0.64	0.89
J	0.195	0.205	4.95	5.21
K	0.095	0.105	2.41	2.67
L	0.060	0.075	1.52	1.91
M	0.085	0.095	2.16	2.41
N	0.018	0.024	0.46	0.61
O	0.178	0.188	4.52	4.78
P	0.045	0.060	1.14	1.52
R	0.038	0.048	0.97	1.22

Dimensions — TO-263AB (N-Package) — D²Pak Surface Mount

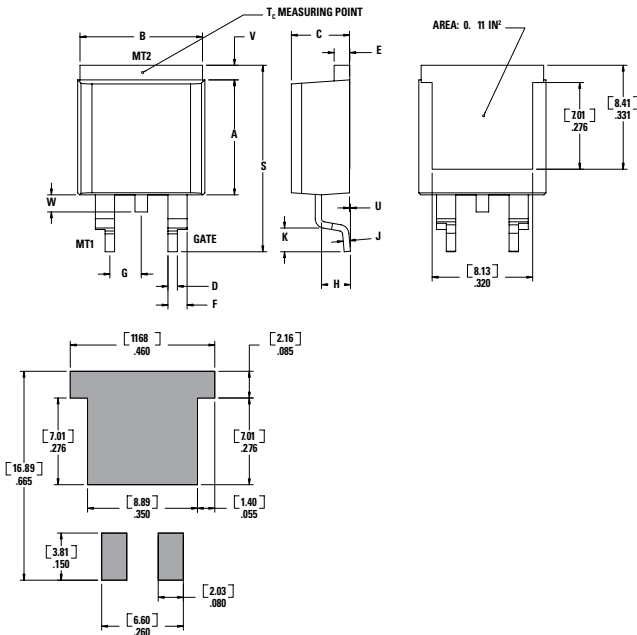

Dimension	Inches		Millimeters	
	Min	Max	Min	Max
A	0.360	0.370	9.14	9.40
B	0.380	0.420	9.65	10.67
C	0.178	0.188	4.52	4.78
D	0.025	0.035	0.64	0.89
E	0.045	0.060	1.14	1.52
F	0.060	0.075	1.52	1.91
G	0.095	0.105	2.41	2.67
H	0.092	0.102	2.34	2.59
J	0.018	0.024	0.46	0.61
K	0.090	0.110	2.29	2.79
S	0.590	0.625	14.99	15.88
V	0.035	0.045	0.89	1.14
U	0.002	0.010	0.05	0.25
W	0.040	0.070	1.02	1.78

Product Selector

Part Number	Voltage				Gate Sensitivity Quadrants I – II – III	Type	Package
	400V	600V	800V	1000V			
Qxx15L5	X	X	X	X	50 mA	Standard Triac	TO-220L
Qxx15R5	X	X	X	X	50 mA	Standard Triac	TO-220R
Qxx15N5	X	X	X	X	50 mA	Standard Triac	TO-263 D ² -PAK
Qxx16LH2	X	X	X	X	10 mA	Alternistor Triac	TO-220L
Qxx16RH2	X	X	X	X	10 mA	Alternistor Triac	TO-220R
Qxx16NH2	X	X	X	X	10 mA	Alternistor Triac	TO-263 D ² -PAK
Qxx16LH3	X	X	X	X	20 mA	Alternistor Triac	TO-220L
Qxx16RH3	X	X	X	X	20 mA	Alternistor Triac	TO-220R
Qxx16NH3	X	X	X	X	20 mA	Alternistor Triac	TO-263 D ² -PAK
Qxx16LH4	X	X	X	X	35 mA	Alternistor Triac	TO-220L
Qxx16RH4	X	X	X	X	35 mA	Alternistor Triac	TO-220R
Qxx16NH4	X	X	X	X	35 mA	Alternistor Triac	TO-263 D ² -PAK
Qxx16LH6	X	X	X	X	80 mA	Alternistor Triac	TO-220L
Qxx16RH6	X	X	X	X	80 mA	Alternistor Triac	TO-220R
Qxx16NH6	X	X	X	X	80 mA	Alternistor Triac	TO-263 D ² -PAK

Packing Options

Part Number	Marking	Weight	Packing Mode	Base Quantity
Qxx15L/RyTP	Qxx15L/Ry	2.2 g	Tube Pack	1000 (50 per tube)
Qxx15NyTP	Qxx15Ny	1.6 g	Tube	1000 (50 per tube)
Qxx15NyRP	Qxx15Ny	1.6 g	Embossed Carrier	500
Qxx16L/RHyTP	Qxx16L/RHy	2.2 g	Tube Pack	1000 (50 per tube)
Qxx16NHyTP	Qxx16NHy	1.6 g	Tube	1000 (50 per tube)
Qxx16NHyRP	Qxx16NHy	1.6 g	Embossed Carrier	500

Note: xx = Voltage/10; y = Sensitivity