

Sure Cross® QM30VT1 Vibration and Temperature Sensor



Datasheet

Continuously monitor machine health, run time, and detect unexpected machine failures such as early bearing failure, unbalance, misalignment, etc. with the Sure Cross Vibration and Temperature QM30VT1 Sensor. The QM30VT1 works in a variety of machines to identify and predict failures in rotating components. Paired with a Sure Cross wireless radio, the QM30VT1 becomes the ultimate predictive maintenance tool for wireless vibration and temperature monitoring.



- Dual-axis vibration detection up to 4 kHz bandwidth
- Output actionable data such as RMS Velocity, RMS High Frequency Acceleration, Peak Velocity, etc., which is pre-processed from the vibration waveforms in the sensor
- Provides high accuracy vibration and temperature measurements
- Industrial grade sensor with small form factor to fit into tight locations
- Manufactured with a sealed aluminum housing
- Connects to Sure Cross Wireless radios for easy set-up, fast installation, and long battery life in even the most rugged, hard-to-reach locations
- Designed to work with 1-wire serial interface radios

For additional information, updated documentation, and a list of accessories, refer to Banner Engineering's website, www.bannerengineering.com.

Models

Model	Housing	Connections and Cable	I/O
QM30VT1	Aluminium; IP67	2.09 m (6.85 ft) cable with a 5-pin M12 male quick disconnect (QD)	Vibration and temperature using a 1-wire serial interface
QM30VT1-QP		150 mm (6 in) cable with a 5-pin M12 male quick disconnect (QD)	
QM30VT1-SS	Stainless steel; IP69K per DIN 40050-9	2.09 m (6.85 ft) cable with a 5-pin M12 male quick disconnect (QD)	
QM30VT1-SS-QP		150 mm (6 in) cable with a 5-pin M12 male quick disconnect (QD)	

The Sensor Configuration Software offers an easy way to manage sensor parameters, retrieve data, and visually show sensor data from a number of different sensors. The Sensor Configuration Software runs on any Windows machine and uses an adapter cable to connect the sensor to your computer. Download the most recent version of the software from Banner Engineering's website: www.bannerengineering.com and select **Software** from the **Products** drop-down list.

Configure this sensor using the [Sensor Configuration Software](#) (instruction manual p/n 170002) and USB-to-RS-232 1-Wire adapter cable model **BWA-USB1WIRE-001** (datasheet p/n 170020).

Holding Registers

By default, the sensor's sample rate is every two and a half minutes. If connected to a Node, then the sample rate is dictated by the Node's sample rate. Use the Sensor Configuration Software to adjust the sensor's sample rate if a different value is needed. The default configuration is shown. The sensor register output data types are user configurable. Use the Sensor Configuration Software to change the output types. All optional output types are listed below. Temperature values outside the operating range of the device are forced to the maximum or minimum values.

The six sensor outputs are read into input registers 1 through 6 of the connected Node as they appear in the User Configuration Software. Sensor outputs can either be configured automatically using DIP switches on some Nodes, such as the Q45VTP, or manually configured by adjusting the Nodes' input register serial addresses with the configuration software. The serial addresses correspond to particular sensor outputs shown in the table below. To view the DIP switch configurations and for more information on how to manually set up Nodes, refer your Node's datasheet.

Sensor Register	Output Type	I/O Range		Holding Register Representation	
		Min	Max	Min (Dec)	Max (Dec)
1	Z-Axis RMS Velocity (in/sec) ^{1, 5}	0	6.5535	0	65535
2	Z-Axis RMS Velocity (mm/sec) ^{2, 5}	0	65.535	0	65535
3	Temperature (°F) ³	-1638.4	1638.3	-32768	32767
4	Temperature (°C) ³	-1638.4	1638.3	-32768	32767
5	X-Axis RMS Velocity (in/sec) ^{1, 5}	0	6.5535	0	65535



Sensor Register	Output Type	I/O Range		Holding Register Representation	
		Min	Max	Min (Dec)	Max (Dec)
6	X-Axis RMS Velocity (mm/sec) ^{2, 5}	0	65.535	0	65535

Serial Address	Modbus Register Alias Address	Optional Output Types	I/O Range		Holding Register Representation	
			Min	Max	Min (dec)	Max (dec)
16	45201	Z-Axis RMS Velocity (in/sec) ^{1, 5}	0	6.5535	0	65535
22	45202	Z-Axis RMS Velocity (mm/sec) ^{2, 5}	0	65.535	0	65535
193	45203	Temperature (°F) ³	-1638.4	1638.3	-32768	32767
192	45204	Temperature (°C) ³	-1638.4	1638.3	-32768	32767
64	45205	X-Axis RMS Velocity (in/sec) ^{1, 5}	0	6.5535	0	65535
70	45206	X-Axis RMS Velocity (mm/sec) ^{2, 5}	0	65.535	0	65535
20	45207	Z-Axis Peak Acceleration (G) ^{2, 6}	0	65.535	0	65535
68	45208	X-Axis Peak Acceleration (G) ^{2, 6}	0	65.535	0	65535
18	45209	Z-Axis Peak Velocity Component Frequency (Hz) ^{4, 5}	0	6553.5	0	65535
66	45210	X-Axis Peak Velocity Component Frequency (Hz) ^{4, 5}	0	6553.5	0	65535
19	45211	Z-Axis RMS Acceleration (G) ^{2, 5}	0	65.535	0	65535
67	45212	X-Axis RMS Acceleration (G) ^{2, 5}	0	65.535	0	65535
24	45213	Z-Axis Kurtosis ^{2, 6}	0	65.535	0	65535
72	45214	X-Axis Kurtosis ^{2, 6}	0	65.535	0	65535
21	45215	Z-Axis Crest Factor ^{2, 6}	0	65.535	0	65535
69	45216	X-Axis Crest Factor ^{2, 6}	0	65.535	0	65535
17	45217	Z-Axis Peak Velocity (in/sec) ^{1, 5}	0	6.5535	0	65535
23	45218	Z-Axis Peak Velocity (mm/sec) ^{2, 5}	0	65.535	0	65535
65	45219	X-Axis Peak Velocity (in/sec) ^{1, 5}	0	6.5535	0	65535
71	45220	X-Axis Peak Velocity (mm/sec) ^{2, 5}	0	65.535	0	65535
25	45221	Z-Axis High-Frequency RMS Acceleration (G) ^{2, 6}	0	65.535	0	65535
73	45222	X-Axis High-Frequency RMS Acceleration (G) ^{2, 6}	0	65.535	0	65535
27		Full Bandwidth RMS Acceleration Z-Axis (G) ^{2, 7}	0	65.535	0	65535
75		Full Bandwidth RMS Acceleration X-Axis (G) ^{2, 7}	0	65.535	0	65535
28		Full Bandwidth Peak Acceleration Z-Axis (G) ^{2, 7}	0	65.535	0	65535
76		Full Bandwidth Peak Acceleration X-Axis (G) ^{2, 7}	0	65.535	0	65535

¹ Value = Register value ÷ 10000

² Value = Register value ÷ 1000

³ Value = Register value ÷ 20 (divide by 100 instead of 20 when using the M-H10 Modbus radio and reading the Modbus register alias address)

⁴ Value = Register value ÷ 10

⁵ Measurement bandwidth = 10 Hz to 1 kHz

⁶ Measurement bandwidth = 1 kHz to 4 kHz

⁷ Measurement Bandwidth = 10 Hz to 4 kHz

Installation Instructions

Connecting the Vibration/Temperature Sensor

To install the sensor to a device with a 5-pin M12 female connector:

1. Align the notch in the female connector with the key in the sensor's male connector.
2. Gently slide the sensor end into the connector.
3. Rotate the threaded nut to tighten the sensor down.

Wiring

This sensor is designed to be plugged directly into compatible Nodes. The Node powers the sensor and periodically requests data using the 1-wire serial interface. Refer to the Class I Division 2 control drawings (p/n [143086](#)) for wiring specifications and limitations.

Table 1: 5-pin M12 connector (male) wiring

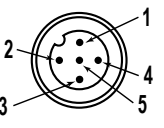
5-pin M12 Connector (Male)	Pin	Wire Color	Sensor Connection
	1	Brown	Power IN (+), 3.6 to 5.5 V DC
	2	White	1-Wire serial device select (sinking input to sensing device)
	3	Blue	Ground (-)
	4	Black	Not used/reserved
	5	Gray	1-Wire serial communications

Installing the QM30VTx Sensor

The vibration sensors have an X and Z axis indication on the face of the sensor. Install the X axis (parallel to sensor) in line with the shaft of the motor or axially. Install the Z axis (plane of the sensor) to go into or through the motor or radial.

For the best results, install the sensor as close to the motor bearing as possible. If this is not possible, install the sensor on a surface that is in rigid connection with vibration characteristics of the motor. Using a cover shroud or other flexible mounting location may result in reduced accuracy or reduced ability to detect certain vibration characteristics. After determining the sensor direction and location, mount the sensor for the best possible vibration sensing accuracy.

Figure 1. Installation direction

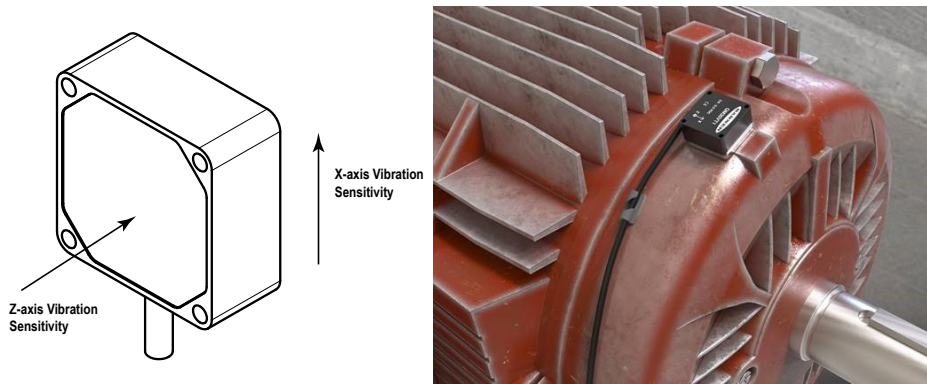

Mounting Options	QM30 Housing Type	Description
BWA-QM30-FTAL	Aluminum	When available, directly mounting the bracket to the motor using an 1/4-28 × 1/2-inch screw provides a rigid surface with the highest sensor accuracy and frequency response. This mounting option offers flexibility for future sensor and bracket movement.
BWA-QM30-FTSS	Stainless steel	Another mounting option is to use an epoxy to adhere the bracket to the motor. Banner recommends using an epoxy designed for accelerometer mounting, such as Loctite Depend 330 and 7388 activator. Epoxying a bracket to a motor provides a permanent installation of the bracket to which the sensor can be attached. This more rigid mounting solution ensures some of the best sensor accuracy and frequency response, but is not flexible for future adjustments. A third option is to use the included thermally conductive adhesive tape. This often provides a more than sufficient mounting type but does introduce some additional flex that reduces accuracy.
BWA-QM30-CEAL Curved bracket epoxied to the motor	Aluminum	This lightweight aluminum bracket provides a close connection to the motor with ridges to sit on curved surfaces and ensure a tight fit. The bracket is epoxied to the motor and the sensor is screwed into the bracket.
BWA-QM30-FMSS Flat magnet bracket	Aluminum and stainless steel	Gives a solid, strong, and adjustable mount to a motor, but with a motor's curved surface it may not provide the best connection if the motor is too small for the magnet to get a full connection with the motor housing. Magnet mounts are susceptible to accidental rotation or a change in the sensor location if an outside force bumps or moves the sensor. This can lead to a change in sensor information that differs from the time-trended data from the previous location. The bracket is stainless steel and the magnet insert is neodymium.
BWA-QM30-CMAL Curved surface magnet bracket	Aluminum and stainless steel	Gives a solid, strong, and adjustable mount to a motor, intended for use when the flat magnetic bracket does not make a good connection with the motor's surface. Magnet mounts are susceptible to accidental rotation or change in the sensor location if an outside force bumps or moves the sensor. This can lead to a change in the sensor information that differs from the time-trended data from the previous location. The bracket is aluminum and the magnet insert is samarium-cobalt.
BWA-QM30-FSALR	Aluminum	This larger aluminum bracket mounts to the motor with a 1/4-28 × 1/2-inch screw to provide a rigid connection to the motor. On the right or left side, a set-screw is hand-tightened to secure the sensor to the bracket, allowing for rapid release and installation of a sensor compared to other mounting options.
BWA-QM30-FSSSR	Stainless steel	This larger stainless steel bracket mounts to the motor with a 1/4-28 × 1/2-inch screw to provide a rigid connection to the motor. A set-screw is hand-tightened to secure the sensor to the bracket, allowing for rapid release and installation of a sensor compared to other mounting options.

Specifications

Supply Voltage

3.6 V DC to 5.5 V DC

Current

Active comms: 3 mA

Communication

Interface: 1-wire serial
 Baud rates: 9.6k, 19.2k (default), or 38.4k
 Data format: 8 data bits, no parity (default), 1 stop bit (even or odd parity available)

Mounting Options

The sensor can be mounted using a variety of methods, including M4 × 0.7 hex screw, epoxy, thermal tape, or magnetic mount.

Shock

MIL-STD-202G, Method 213B, Condition I (100G 6x along X, Y, and Z axes, 18 shocks), with device operating

Certifications



Vibration Sensor

Measuring Range: 0 to 46 mm/sec or 0 to 1.8 in/sec RMS
 Frequency Range: 10 Hz to 4 kHz
 Accuracy: ±10% at 25 °C
 Sampling Frequency: 20 kHz (default)
 Record Length: 8192 points (default)
 Sample Duration: 0.4 s (default)

Temperature Sensor

Measuring Range: -40 °C to +105 °C (-40 °F to +221 °F)
 Resolution: 1 °C
 Accuracy: ± 3 °C
 Operating the sensor at higher voltages can induce internal heating that can reduce the accuracy.

Environmental Rating

Aluminium housing: IP67
 Stainless steel housing: IP69K per DIN 40050-9

Operating Temperature

-40 °C to +105 °C (-40 °F to +221 °F) ¹

Maximum Cable Length

H10 Data Radios: From any single sensor to the radio: 40 meters (131 feet)
 All other radios: 10 meters (33 feet)

Compatible Nodes—All models are available for either 900 MHz or 2.4 GHz; substitute a 9 (900 MHz) or a 2 (2.4 GHz) for the * shown in the model number.

- Battery powered DX80N*X1S-P6 or DX80N*X1W-P6L (datasheet [157189](#))
- Condition Monitoring Node DX80N*X1W-CM1L (datasheet [209565](#))
- Wireless Q45 DX80N*Q45VTP (datasheet [208637](#))
- 10 to 30 V DC power DX80N*X6S-P6 (datasheet [157189](#))
- MultiHop DX80DR*M-H6 (datasheet [152725](#))
- MultiHop DX80DR*M-H10 (datasheet [214151](#))



WARNING:

- **Do not use this device for personnel protection**
- Using this device for personnel protection could result in serious injury or death.
- This device does not include the self-checking redundant circuitry necessary to allow its use in personnel safety applications. A device failure or malfunction can cause either an energized (on) or de-energized (off) output condition.

Vibration Severity Per ISO 10816

ISO 10816 provides guidance for evaluating vibration velocity severity motors, pumps, fans, compressors, gear boxes, blowers, dryers, presses, and other machines that operate in the 10 to 1000 Hz frequency range.

Figure 2. Vibration Severity per ISO 10816

Machine		Class I	Class II	Class III	Class IV	
		Small Machines	Medium Machines	Large Rigid Foundation	Large Soft Foundation	
Vibration Velocity Vrms	in/s	mm/s				
	0.01	0.28				
	0.02	0.45				
	0.03	0.71		good		
	0.04	1.12				
	0.07	1.80				
	0.11	2.80		satisfactory		
	0.18	4.50				
	0.28	7.10		unsatisfactory		
	0.44	11.2				
	0.70	18.0				
	1.10	28.0		unacceptable		
1.77	45.9					

¹ Operating the devices at the maximum operating conditions for extended periods can shorten the life of the device.

Battery Life for a P6 Node Connected to a Vibration and Temperature (VT1) Sensor

The following battery life estimates use the default configuration of the Performance P6 Node, which is a 5 minute sample and report rate.

- 900 MHz 1 Watt: 2.5 years
- 900 MHz 250 mW: 3.4 years
- 2.4 GHz: 4.3 years

Battery Life for a Q45VA or Q45VT/Q45U Node with 1-Wire Serial Sensor

This is the battery life curve for the following models:

- Q45VT or Q45U 1-Wire Serial Interface Node connected to a 1-wire serial sensor (such as a VT1 Vibration/Temperature sensor)
- Q45VTP Node

Figure 3. Battery life for the Q45VA, VT, and U Nodes

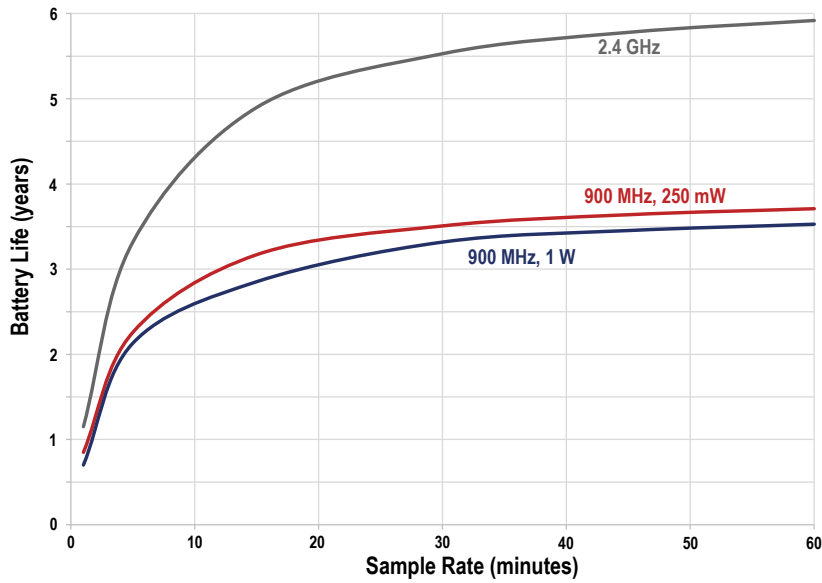

Dimensions

All measurements are listed in millimeters [inches], unless noted otherwise.

Figure 4. Aluminium model

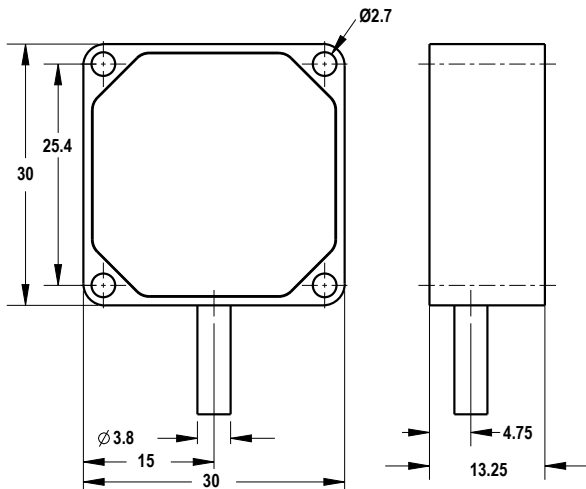
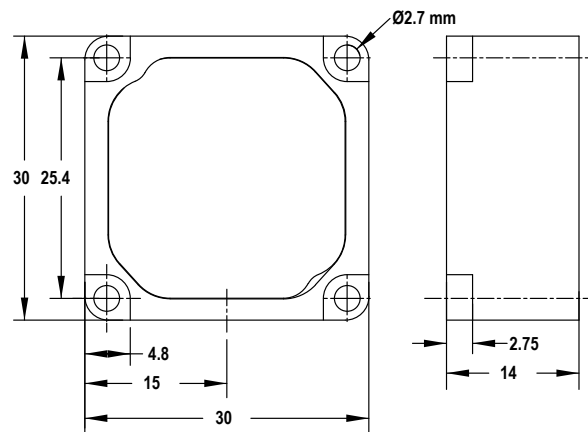

Figure 5. Stainless steel models



Accessories

Brackets

Bracket **BWA-QM30-FTAL** is included with the aluminium sensor models. Bracket **BWA-QM30-FTSS** is included with the stainless steel models. All other brackets are available for order, but are not included with the sensor.

BWA-QM30-FTSS

- Use when measuring high frequency vibrations or when mounting the sensor to curved surfaces
- Includes **SMBQM30** stainless steel bracket, four mounting screws, and one ¼-28 × 1/2 screw mount
- 30 mm × 30 mm
- **Refer to the Bracket Assembly Quick Start Guide for installation instructions (p/n 213323)**

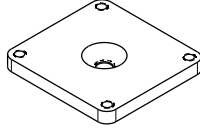

BWA-QM30-FMSS

- Includes magnetic mounting bracket **SMBQM30** and four mounting screws (two sets of mounting screws for both the aluminum and stainless steel models)
- 30 mm × 30 mm
- **Refer to the Bracket Assembly Quick Start Guide for installation instructions (p/n 213323)**

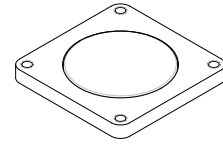

BWA-QM30-FTAL

- Use when measuring high frequency vibrations or when mounting the sensor to curved surfaces
- Includes **SMBQM30** aluminum bracket, four mounting screws, one ¼-28 × 1/2 screw mount, and one piece of 3M™ thermally conductive adhesive transfer tape
- 30 mm × 30 mm
- **Refer to the Bracket Assembly Quick Start Guide for installation instructions (p/n 213323)**

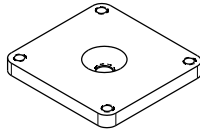

BWA-QM30-CMAL

- Magnet mount for curved surfaces
- 30 mm × 30 mm, 14.4 mm thick
- Includes four M2.5 × 16 mm socket head cap screws
- **Refer to the Bracket Assembly Quick Start Guide for installation instructions (p/n 213323)**

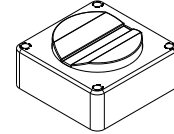

BWA-QM30-CEAL

- Glue-mount for curved surfaces
- Aluminum

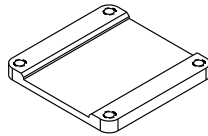

BWA-QM30-FSALR Flat Surface Rapid Release Bracket (Aluminum)

- Aluminum
- Circular bracket with center screw for mounting the bracket to the motor
- Side set-screw for quick release mounting of the sensor to the bracket

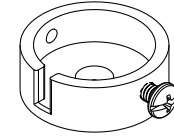

BWA-QM30-FSSSR Flat Surface Rapid Release Bracket (Stainless Steel)

- Stainless steel
- Circular bracket with center screw for mounting the bracket to the motor
- Side set-screw for quick release mounting of the sensor to the bracket

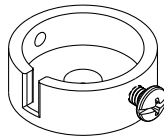

BWA-QM30CAB-MAG

- QM30 Magnet Cable Placement Bracket **BWA-BK-027**
- Snap clip polypropylene bracket with magnetic backing for securing QM30 cables
- Set of ten brackets in each container

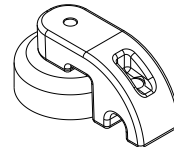

Cordsets

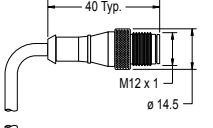
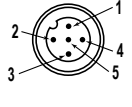
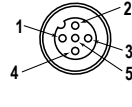
5-Pin Threaded M12 Cordsets—Double Ended					
Model	Length	Style	Dimensions	Pinout (Male)	Pinout (Female)
MQDEC-501SS	0.31 m (1.02 ft)	Male Straight/ Female Straight			
MQDEC-503SS	0.91 m (2.99 ft)				
MQDEC-506SS	1.83 m (6 ft)				
MQDEC-512SS	3.66 m (12 ft)				
MQDEC-515SS	5 m (16.4 ft)				
MQDEC-530SS	9 m (29.5 ft)				
MQDEC-550SS	15 m (49.2 ft)				

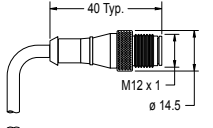
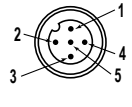
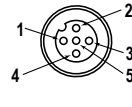
5-Pin Threaded M12 Stainless Steel Washdown Cordsets—Double Ended					
Model	Length	Style	Dimensions	Pinout (Male)	Pinout (Female)
MQDEC-WDSS-505SS	1.52 m (4.99 ft)	Male Straight/ Female Straight			
MQDEC-WDSS-510SS	3.05 m (10 ft)				
MQDEC-WDSS-515SS	4.57 m (15 ft)				

USB to 1-Wire Serial Interface Adapter—Use with the Sensor Configuration Software to communicate directly with 1-wire serial interface sensors; datasheet: [170020](#)

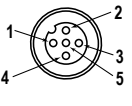
5-Pin Threaded M12 1-Wire Serial to USB Adapter Cordset					
Model	Length	Style	Dimensions	Pinout (Female)	
BWA-USB1WIRE-001	1 m (39 in)	Straight			

Use the splitter tee with the M-H10 MultiHop Data Radio to connect more than one QM30VT1 sensor.

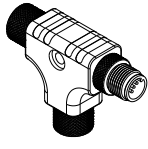
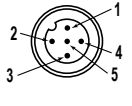
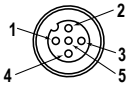
5-Pin Threaded M12 Splitter Tee					
Model	Description	Dimensions	Pinout (Male)	Pinout (Female)	
CSB-M1250M1250-T	Female trunk, 1 female branch, 1 male branch				

Use the splitter cable with the M-H10 MultiHop Data Radio to connect more than one QM30VT1 sensor.