

Datasheet



- Compact, rugged, low cost self-contained sensors in metal die cast housings
- Epoxy-encapsulated circuitry; leakproof IP67 (NEMA 6) construction for harsh environments
- Outstanding electrical noise immunity
- Dual LED system indicates sensor performance
- Choice of integral cable or quick disconnect connector



WARNING: Not To Be Used for Personnel Protection

Never use this device as a sensing device for personnel **protection**. Doing so could lead to serious injury or death. This device does not include the self-checking redundant circuitry necessary to allow its use in personnel safety applications. A sensor failure or malfunction can cause either an energized or de-energized sensor output condition.

Models

QM42 Opposed Mode Emitter (E) and Receiver (R)		
Models	Cable	Output Type
QM426E Emitter	2 m (6.5 ft)	-
QM426EQ Emitter	4-pin Euro QD	
QM42VN6R Receiver	2 m (6.5 ft)	NPN
QM42VN6RQ Receiver	4-pin Euro QD	
QM42VP6R Receiver	2 m (6.5 ft)	PNP
QM42VP6RQ Receiver	4-pin Euro QD	

QM42 Plastic Fiber Optic Mode		
Models	Cable	Output Type
QM42VN6FP	2 m (6.5 ft)	NPN
QM42VN6FPQ	4-pin Euro QD	
QM42VP6FP	2 m (6.5 ft)	PNP
QM42VP6FPQ	4-pin Euro QD	

QM42 Diffuse Mode		
Models	Cable	Output Type
QM42VN6D	2 m (6.5 ft)	NPN
QM42VN6DQ	4-pin Euro QD	
QM42VP6D	2 m (6.5 ft)	PNP
QM42VP6DQ	4-pin Euro QD	

QM42 Polarized Retroreflective Mode		
Models	Cable	Output Type
QM42VN6LP	2 m (6.5 ft)	NPN
QM42VN6LPQ	4-pin Euro QD	
QM42VP6LP	2 m (6.5 ft)	PNP
QM42VP6LPQ	4-pin Euro QD	

To order the 9 m (30 ft) cable models, add the suffix "W/30" to the model number of any cabled sensor (for example, QM42VN6D W/30). Models with a QD connector require a mating cable.

Specifications

Sensing Beam

Infrared, 880 nm for opposed and diffuse
Visible red, 660 nm for fiber optic and retroreflective modes

Supply Voltage and Current

10 to 30 V dc (10% maximum ripple) at less than:
Diffuse and retroreflective models: 20 milliamps
Opposed mode: 30 milliamps (emitter), 10 milliamps (receiver)
Fiber optic models: 30 milliamps

Supply **Protection** Circuitry

Protected against reverse polarity and transient voltages

Output **Configuration**

SPDT (complementary) solid-state dc switch; Choose NPN (current sinking) or PNP (current sourcing) models.
Light operate: N.O. output conducts when the sensor sees its own (or the emitter's) modulated light
Dark operate: N.C. output conducts when the sensor sees dark

Output **Rating**

100 mA maximum (each output)
Off-state leakage current: < 5 microamps at 30 V dc
On-state saturation voltage: < 1 V at 10 mA dc; < 1.5 V at 100 mA dc

Repeatability

Diffuse and retroreflective modes: 250 microseconds
Opposed Mode: 120 microseconds
Fiber optic mode: 60 microseconds

Adjustments

All models except emitters: 15-turn slotted brass GAIN (sensitivity) adjustment potentiometer (clutched at both ends of travel)

Indicators

Two LEDs: green and amber
Green solid = power to sensor is on (Opposed emitters: Green power "on")
Green flashing = output is overloaded
Amber solid = light is sensed; normally open output on
Amber flashing = marginal excess gain (1-1.5x) in light condition

Construction

Housings are die-cast zinc alloy with black epoxy powder paint finish; lenses are acrylic

Connections

2 m (6.5 ft) or 9 m (30 ft) attached cable, or 4-pin Euro-style quick-disconnect fitting; Cables for QD models are purchased separately



Output Protection Circuitry

Protected against false pulse on power-up and continuous overload or short-circuit of outputs
 Overload trip point ≥ 150 mA, typical, at 20 °C

Output Response Time

Diffuse and retroreflective modes: 1 millisecond on and off
 Opposed mode: 1 millisecond on, 0.5 millisecond off
 Fiber optic mode: 0.25 millisecond on and off

Environmental Rating

IP67; NEMA 6

Operating Conditions

Temperature: -20 °C to +70 °C (-4 °F to +158 °F)
 Relative Humidity: 90% at +50 °C maximum relative humidity (non-condensing)

Certifications



Required Overcurrent Protection



WARNING: Electrical connections must be made by qualified personnel in accordance with local and national electrical codes and regulations.

Overcurrent protection is required to be provided by end product application per the supplied table.
 Overcurrent protection may be provided with external fusing or via Current Limiting, Class 2 Power Supply.
 Supply wiring leads < 24 AWG shall not be spliced.
 For additional product support, go to www.bannerengineering.com.

Supply Wiring (AWG)	Required Overcurrent Protection (Amps)
20	5.0
22	3.0
24	2.0
26	1.0
28	0.8
30	0.5

Performance Curves

Plastic Fiber Optic Mode - Range: 40 mm (1.5 in)

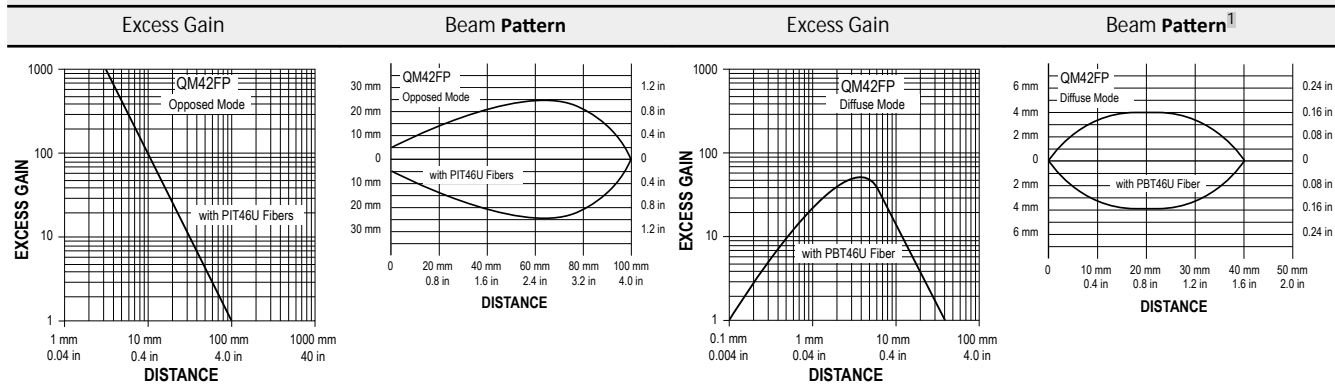

Opposed Mode - Range: 10 m (33 ft)

Diffuse Mode - Range: 400 mm (16 in)

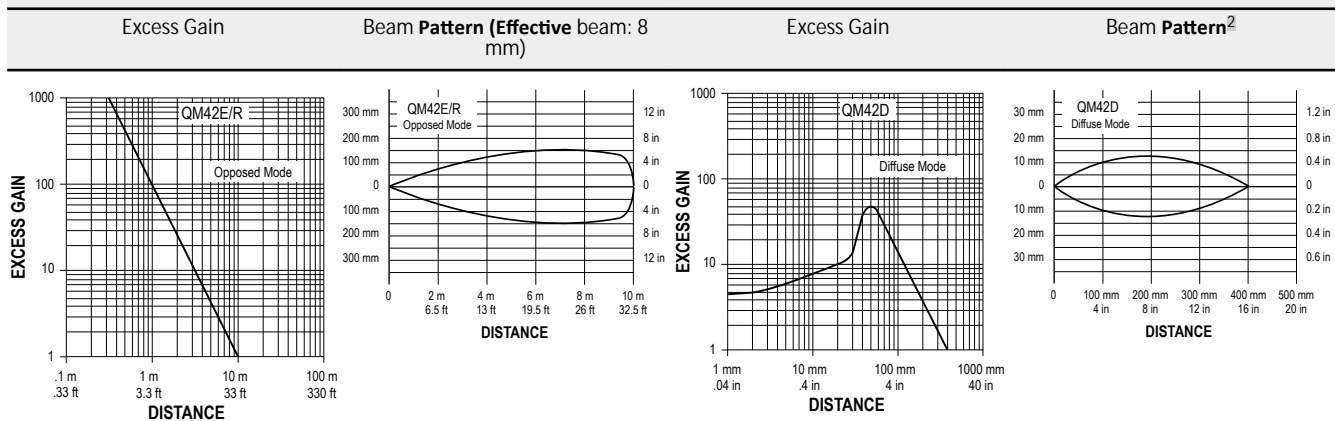

¹ Diffuse mode performance is based on a 90% reflectance white test card.
² Performance is based on a 90% reflectance white test card.

Polarized **Retroreflective** Mode - Range: 3 m (10 ft)

Excess Gain

Beam Pattern

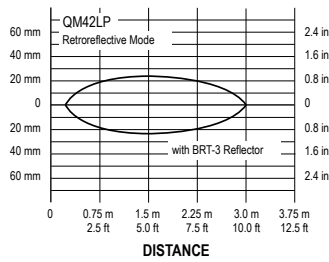
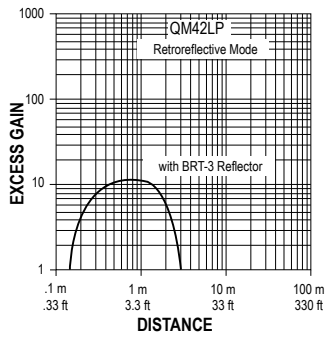

Dimensions

Cabled **Diffuse**, **Opposed**, and **Retroreflective** Models

Quick Disconnect Models

Quick Disconnect FP Models

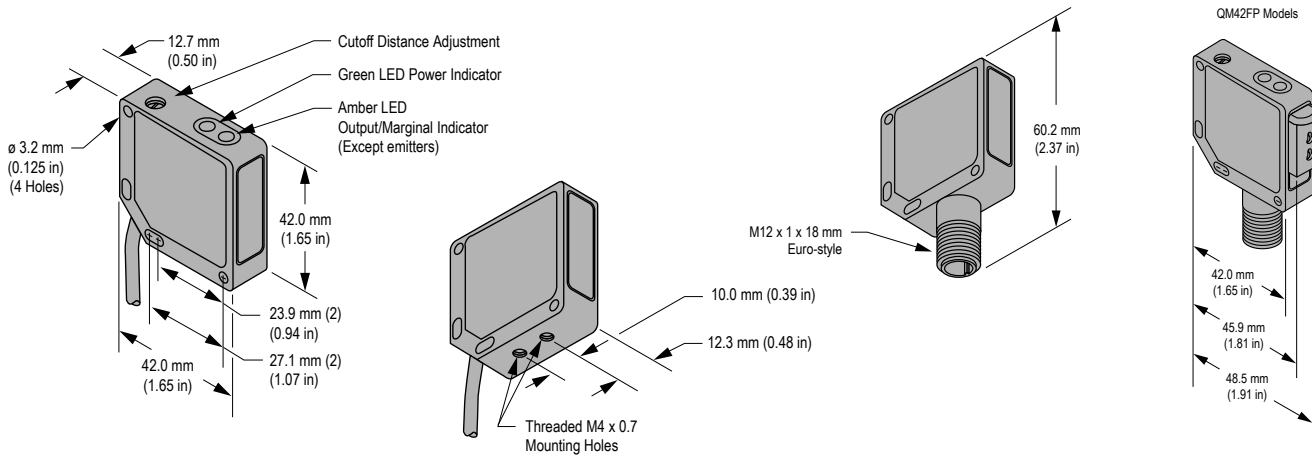

Wiring Diagrams

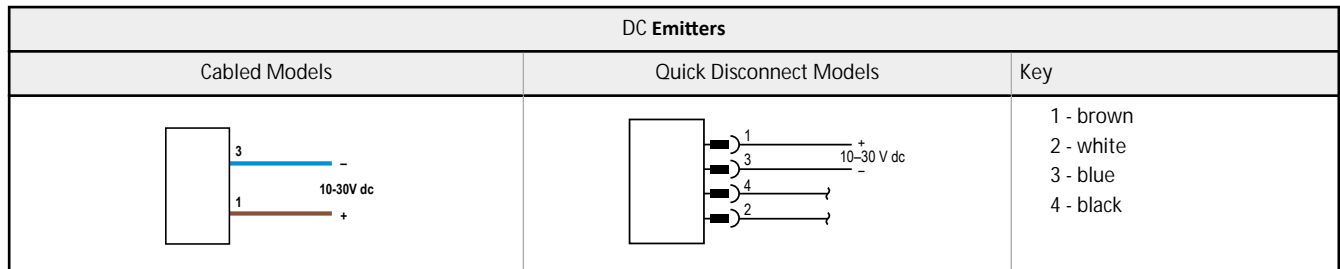
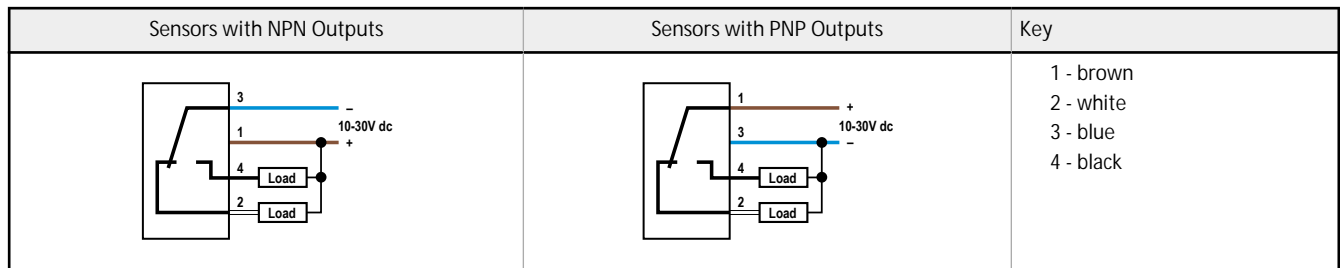

Cabled models are shown. Quick disconnect (QD) wiring diagrams are functionally identical.