

QMT42 Series 400 mm Adjustable Field Sensors



Datasheet

Sensing cutoff point is adjustable from 125 mm to 400 mm (5 in to 16 in)



- Adjustable field technology allows direct detection of objects within a defined sensing field, while completely ignoring reflective objects located beyond the sensing field cutoff point
- Reliable electronic adjustment¹ of sensing field cutoff point from 125 mm to 400 mm; no mechanical adjustments to worry about
- Low-cost, compact, rugged sensors in metal die-cast housings
- Epoxy-encapsulated circuitry; leakproof IP67 (NEMA 6) construction for reliable sensing in harsh environments
- Outstanding electrical noise immunity
- Dual LED system indicates sensor performance
- Choice of integral cable or quick disconnect connector



WARNING: Not To Be Used for Personnel Protection

Never use this device as a sensing device for personnel protection. Doing so could lead to serious injury or death. This device does not include the self-checking redundant circuitry necessary to allow its use in personnel safety applications. A sensor failure or malfunction can cause either an energized or de-energized sensor output condition.

Models

Models	Range	Cutoff Point	Cable	Supply Voltage	Output Type
QMT42VN6AFV400	25 mm (1 in) to Cutoff point	125 mm to 400 mm (5 in to 16 in)	2 m (6.5 ft)	10 V dc to 30 V dc	NPN
QMT42VN6AFV400Q			4-pin Euro QD		
QMT42VP6AFV400			2 m (6.5 ft)		PNP
QMT42VP6AFV400Q			4-pin Euro QD		

Adjustable Field Sensing – Theory of Operation

The receiver element of an adjustable field sensor produces two currents: I1 and I2. The ratio of these two currents changes as the received light signal moves along the length of the receiver element. See [Figure 1](#) on page 2. The sensing cutoff distance relates directly to this ratio, which can be adjusted using the sensor's multi-turn potentiometer.

The cutoff distance for model QMT...AF... sensors is adjustable from 125 to 400 millimeters (5 to 16 inches) Objects lying beyond the cutoff distance are usually ignored, even if they are highly reflective. However, under certain conditions, it is possible to falsely detect a background object (see [Placement](#) on page 2).

As a general rule, the most reliable sensing of an object which approaches from the side occurs when the line of approach is parallel to the sensing axis.

¹ Patent Pending



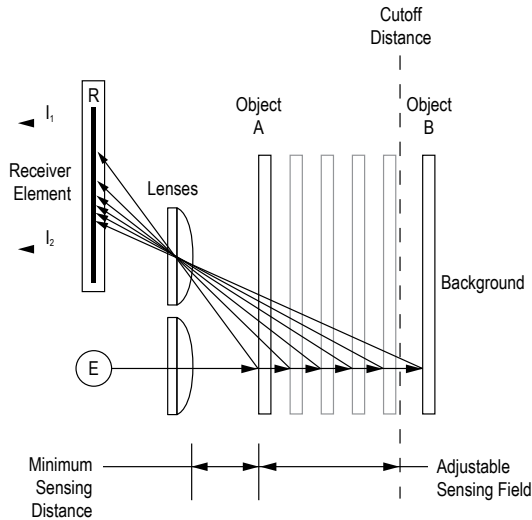

Figure 1. Adjustable Field Sensing Concept

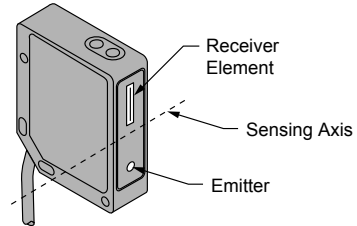
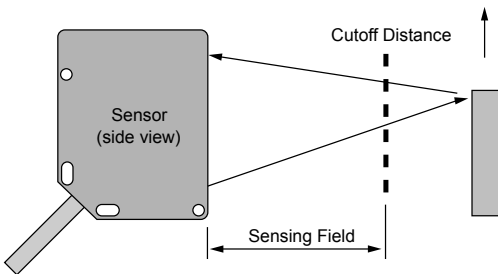

Figure 2. Fixed-Field Sensing Axis

Placement

An object beyond the cutoff distance, either stationary (and when positioned as shown in [Figure 3](#) on page 2), or moving past the face of the sensor in a direction perpendicular to the sensing axis, may cause unwanted triggering of the sensor if more light is reflected to the near detector than to the far detector. Correct the problem by rotating the sensor 90° ([Figure 4](#) on page 2). The object then reflects the R1 and R2 fields equally, resulting in no false triggering. A better solution, if possible, may be to reposition the object or the sensor.



A reflective background object in this position or moving across the sensor face in this axis and direction may cause a false sensor response.

Figure 3. Object Beyond Cutoff - Problem

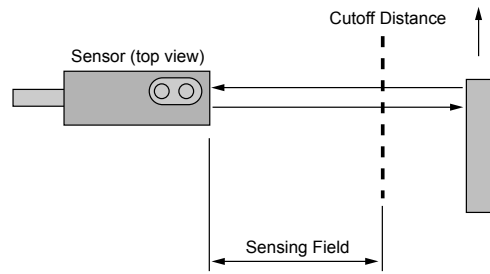

A reflective background object in this position or moving across the sensor face in this axis is ignored.

Figure 4. Object Beyond Cutoff - Solution

Specifications

Sensing Beam

Visible red, 680 nm

Supply Voltage and Current

10 V dc to 30 V dc (10% maximum ripple) at less than 50 mA

Supply Protection Circuitry

Protected against reverse polarity and transient voltages

Output Configuration

SPDT (complementary) solid-state dc switch; Choose NPN or PNP models
 Light operate: N.O. output conducts when the sensor sees its own (or the emitter's) modulated light
 Dark operate: N.C. output conducts when the sensor sees dark

Output Configuration

SPDT (complementary) solid-state dc switch; choose NPN or PNP models
 Light operate: N.O. output conducts when the sensor sees its own modulated light
 Dark operate: N.C. output conducts when the sensor sees dark

Output Rating

100 mA maximum (each output)
 OFF-state leakage current: < 5 microamps at 30 V dc
 ON-state saturation voltage: < 1 V at 10 mA dc; < 1.5 V at 100 mA dc

Output Protection Circuitry

Protected against false pulse on power-up and continuous overload or short-circuit of outputs
 Overload trip point \geq 150 mA, typical, at 20 °C

Output Response Time

1 millisecond on and off



Note: 100 millisecond delay on power-up; outputs are non-conducting during this time

Repeatability of Response

250 microseconds

Sensing Hysteresis

Less than 7% of set cutoff distance

Adjustments

All models have a 15-turn slotted brass cutoff distance adjustment potentiometer (clutched at both ends of travel)

Indicators

Two LEDs: Green and Amber
 Green on steady = power to sensor is ON
 Green flashing = output is overloaded
 Amber on steady = light is sensed; normally open output ON
 Amber flashing = marginal excess gain (1-1.5x) in light condition

Construction

Housings are die-cast zinc alloy with black acrylic polyurethane finish; lenses are acrylic

Environmental Rating

IEC IP67/NEMA 6

Connections

2 m (6.5 ft) or 9 m (30 ft) attached cable, or 4-pin M12/Euro-style quick-disconnect fitting; cables for QD models are purchased separately

Operating Conditions

Operating Temperature: -20 °C to +55 °C (-4 °F to +131°F)
 90% at +50 °C maximum relative humidity (non-condensing)

Required Overcurrent Protection



WARNING: Electrical connections must be made by qualified personnel in accordance with local and national electrical codes and regulations.

Overcurrent protection is required to be provided by end product application per the supplied table.
 Overcurrent protection may be provided with external fusing or via Current Limiting, Class 2 Power Supply.
 Supply wiring leads < 24 AWG shall not be spliced.
 For additional product support, go to <http://www.bannerengineering.com>.

Supply Wiring	Required Overcurrent Protection
20	5.0 Amps
22	3.0 Amps
24	2.0 Amps
26	1.0 Amps
28	0.8 Amps
30	0.5 Amps

Certifications



Cutoff Point Deviation

The percentage of deviation indicates a change in the cutoff point for either 18% gray or 6% black targets, relative to the cutoff point for a 90% reflective white test card. As an example, the cutoff point decreases 10% for a 6% reflectance black target when the cutoff point is 400 millimeters (16 inches) using a 90% reflectance white test card. In other words, the cutoff point for the black target is 360 millimeters (14 inches).

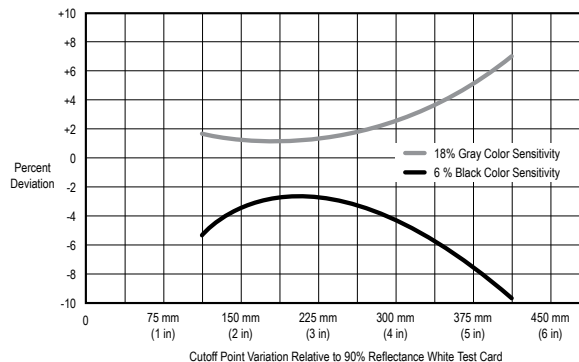

Dimensions

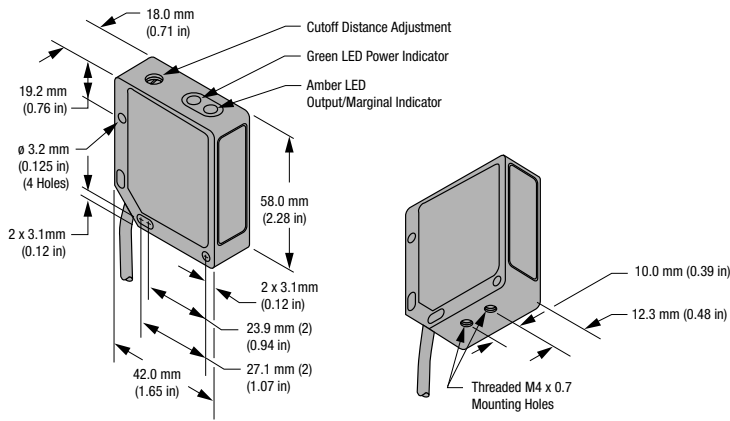

Figure 5. Cabled Models

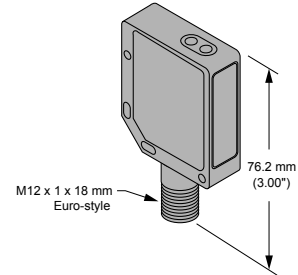

Figure 6. Quick-Disconnect Models

All measurements are listed in millimeters (inches), unless noted otherwise.

Wiring

Sensors with NPN Outputs		Sensors with PNP Outputs	
Cabled Models	Quick-Disconnect Models	Cabled Models	Quick-Disconnect Models

Accessories

Quick-Disconnect (QD) Cables

4-Pin Threaded M12/Euro-Style Cordsets				
Model	Length	Style	Dimensions	Pinout (Female)
MQDC-406	1.83 m (6 ft)	Straight		<p>1 = Brown 2 = White 3 = Blue 4 = Black</p>
MQDC-415	4.57 m (15 ft)			
MQDC-430	9.14 m (30 ft)			
MQDC-450	15.2 m (50 ft)			
MQDC-406RA	1.83 m (6 ft)	Right-Angle		
MQDC-415RA	4.57 m (15 ft)			
MQDC-430RA	9.14 m (30 ft)			
MQDC-450RA	15.2 m (50 ft)			