

Product Overview

Qorvo's QPA0812 is a packaged, high performance power amplifier fabricated on Qorvo's production QPHT15 (0.15um) pHEMT process. Covering 8.5- 10.5 GHz, the QPA0812 provides > 1 W of saturated output power and 24 dB of large-signal gain while achieving 48% power-added efficiency.

Packaged in a small 4 x 3 mm plastic overmold QFN, tight lattice spacing requirements for phased array radar applications is easily supported. RF input and output ports are matched to 50Ω and include integrated DC blocking capacitors.

Lead-free and RoHS compliant.

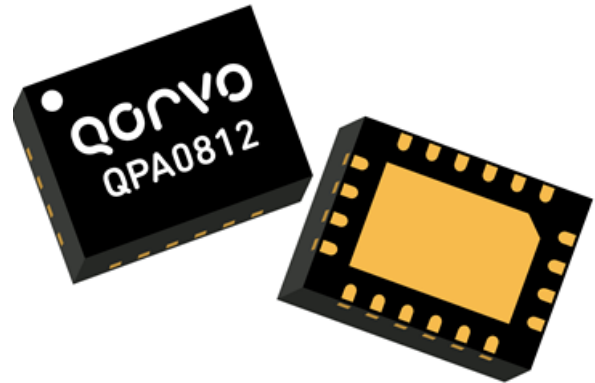

4 mm x 3 mm plastic overmold QFN

Key Features

- Frequency Range: 8.5 – 10.5 GHz
- Output Power ($P_{IN} = 6 \text{ dBm}$): 30.8 dBm
- PAE ($P_{IN} = 6 \text{ dBm}$): 48.2 %
- Small Signal Gain: 34.4 dB
- Recommended Bias: $V_D = 6 \text{ V}$, $I_{DQ} = 156 \text{ mA}$
- Package Size: 4.0 mm x 3.0 mm x 0.85 mm

Functional Block Diagram

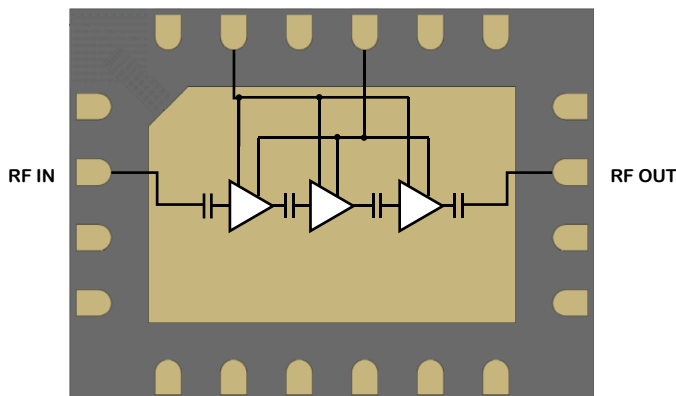

Top View

Applications

- Radar
- Electronic Warfare

Ordering Information

Part No.	Description
QPA0812	1 Watt X-Band Power Amplifier
QPA0812TR7	500 pcs. on 7 inch reel
QPA0812EVB	QPA0812 Evaluation Board

Absolute Maximum Ratings

Parameter	Rating
Drain Voltage (V_D)	6.5 V
Gate Voltage Range (V_G)	-5 to 0 V
Drain Current (I_D)	635 mA
Gate Current (I_G)	10 mA
Power Dissipation (P_{DISS}), CW, $T_{BASE} = 85\text{ }^\circ\text{C}$	1.37 W
Input Power (P_{IN}), Pulsed (100us/10%), 50 Ω , $V_D = 6\text{ V}$, $T_{BASE} = 85\text{ }^\circ\text{C}$	16 dBm
Input Power (P_{IN}), Pulsed (100us/10%), VSWR 3:1, $V_D = 6\text{ V}$, $T_{BASE} = 85\text{ }^\circ\text{C}$	16 dBm
Mounting Temperature (30 seconds max.)	260 $^\circ\text{C}$
Storage Temperature	-55 to 150 $^\circ\text{C}$

Exceeding any one or a combination of the Absolute Maximum Rating conditions may cause permanent damage to the device. Extended application of Absolute Maximum Rating conditions to the device may reduce device reliability.

Recommended Operating Conditions

Parameter	Typ
Drain Voltage (V_D)	6 V
Drain Current (I_{DQ})	156 mA
Drain Current Under RF Drive (I_{D_DRIVE})	See plots pp. 3, 5-11

Electrical specifications are measured at specified test conditions. Specifications are not guaranteed over all recommended operating conditions.

Electrical Specifications

Parameter	Conditions	Min	Typ	Max	Units
Operational Frequency		8.5		10.5	GHz
Output Power ($P_{IN} = 6\text{ dBm}$)	Pulsed V_D		30.8		dBm
Power Added Efficiency ($P_{IN} = 6\text{ dBm}$)	Pulsed V_D		48.2		%
Small Signal Gain (CW)			34.4		dB
Input Return Loss (CW)			17		dB
Output Return Loss (CW)			9		dB
2 ND Harmonic ($P_{IN} = 6\text{ dBm}$)	Pulsed V_D		-35		dBc
3 RD Harmonic ($P_{IN} = 6\text{ dBm}$)	Pulsed V_D		-36		dBc
P_{OUT} Temp. Coeff. (85 $^\circ\text{C}$ to -40 $^\circ\text{C}$, $P_{IN} = 6\text{ dBm}$)	Pulsed V_D		-0.002		dB/ $^\circ\text{C}$
Sm. Sig. Gain Temp. Coefficient (85 $^\circ\text{C}$ to -40 $^\circ\text{C}$)			-0.023		dB/ $^\circ\text{C}$
Gate Leakage Current	$V_D = 6\text{ V}$, $V_G = -3.3\text{ V}$	-1		1	mA

Test conditions, unless otherwise noted: $T = +25\text{ }^\circ\text{C}$, $V_D = 6\text{ V}$, $I_{DQ} = 156\text{ mA}$, Pulse Width = 100 us, Duty Cycle = 10%

Performance Plots – Large Signal (Pulsed)

Test conditions unless otherwise noted: T = +25 °C, V_D = 6 V, I_{DQ} = 156 mA, P_{IN} = 6 dBm, Pulse Width = 100 us, Duty Cycle = 10%

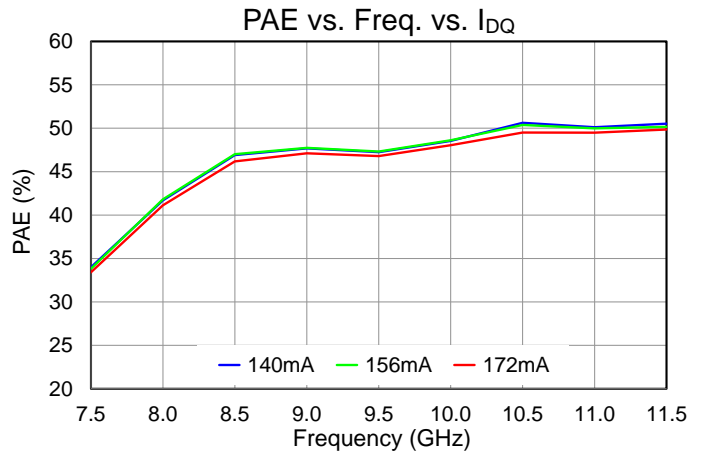
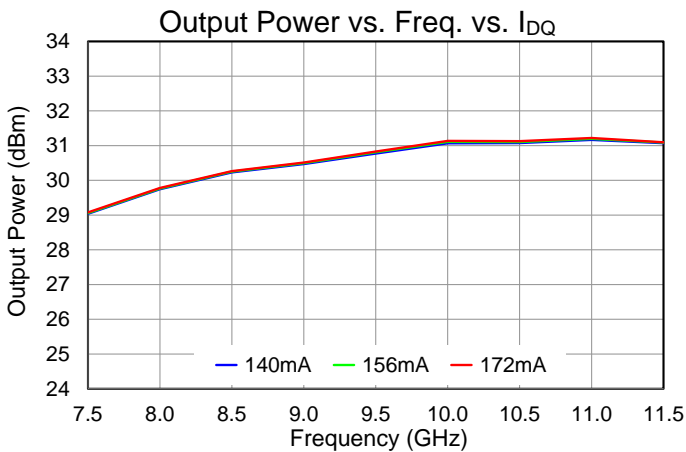
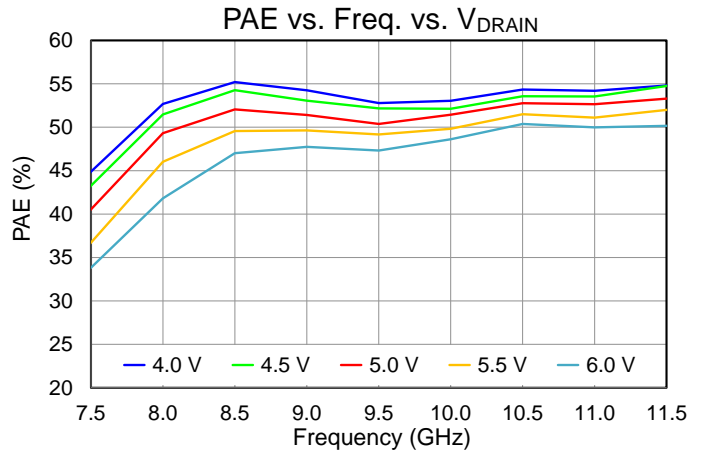
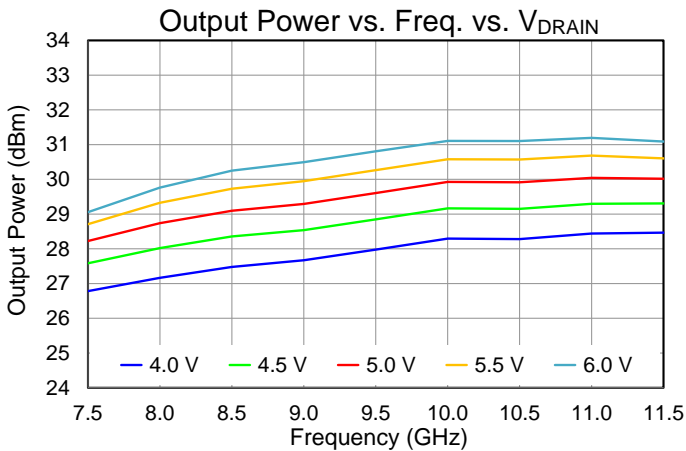
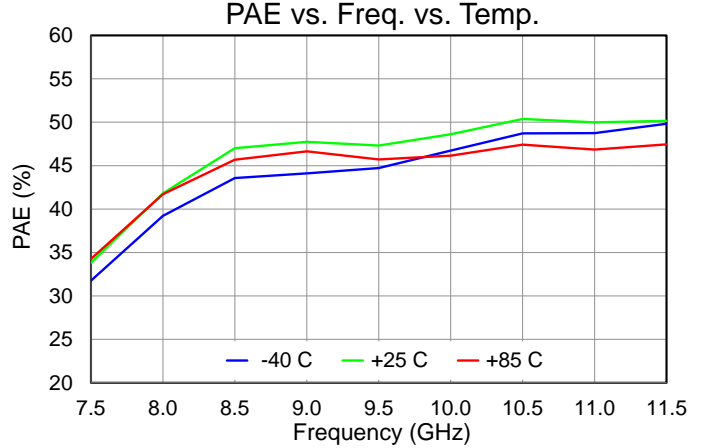
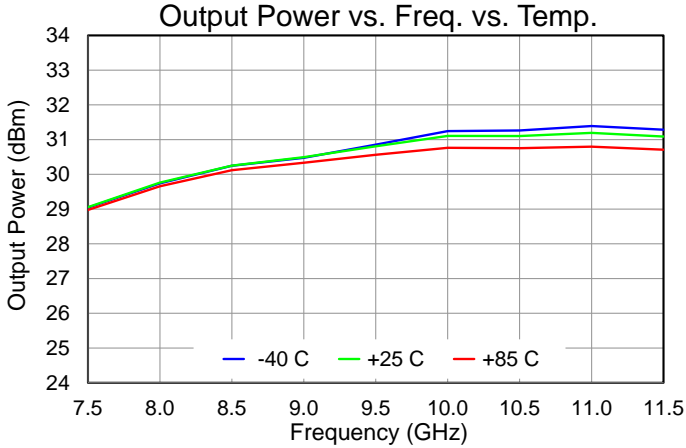

Performance Plots – Large Signal (Pulsed)

Test conditions unless otherwise noted: T = +25 °C, V_D = 6 V, I_{DQ} = 156 mA, P_{IN} = 6 dBm, Pulse Width = 100 us, Duty Cycle = 10%

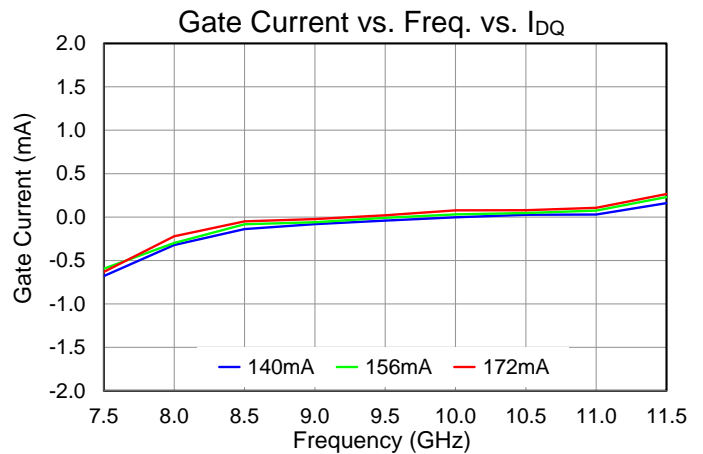
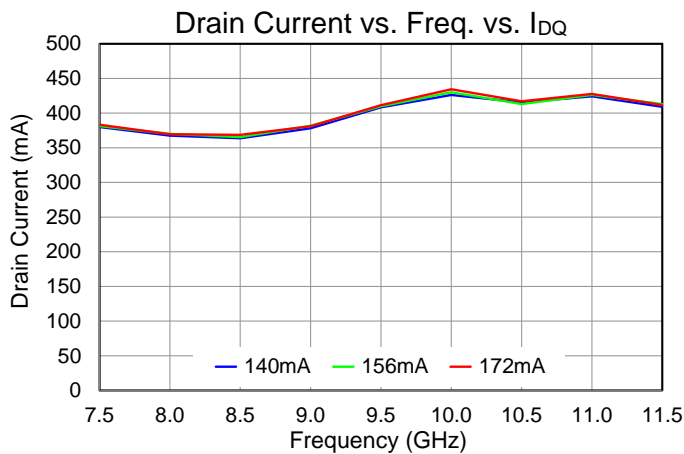
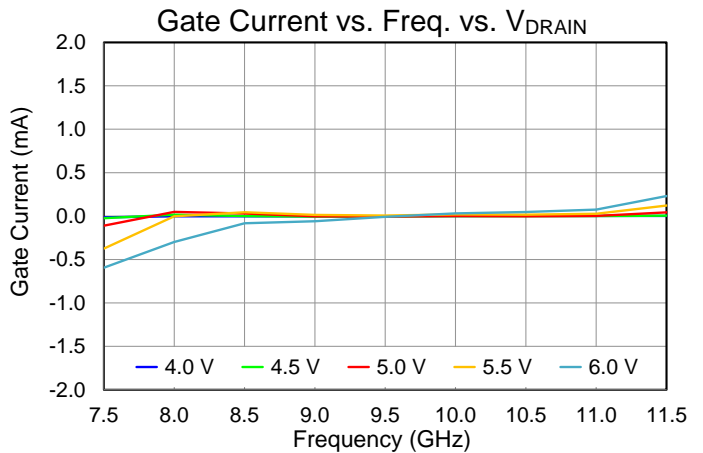
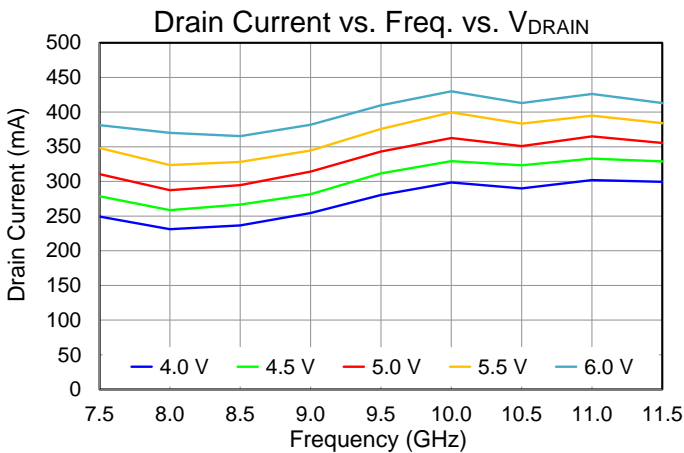
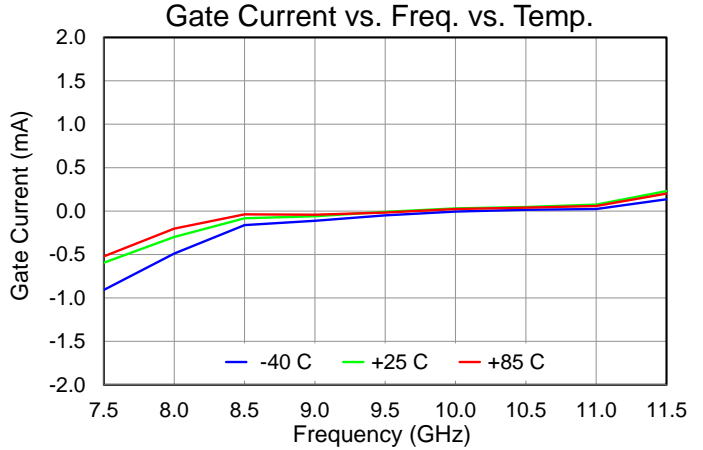
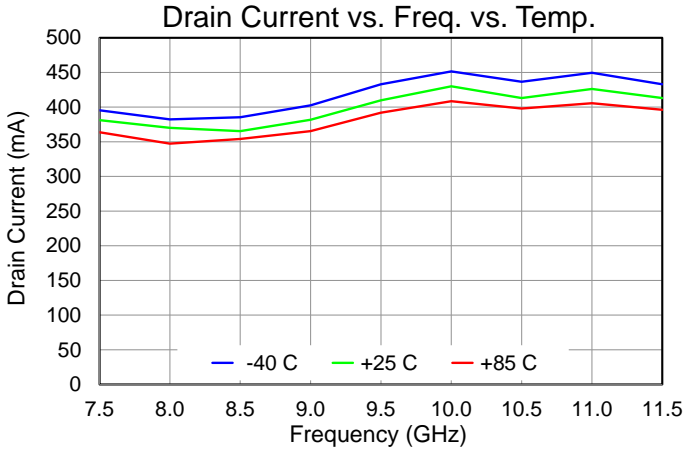

Performance Plots – Large Signal (Pulsed)

Test conditions unless otherwise noted: T = +25 °C, VD = 6 V, IDQ = 156 mA, Pulse Width = 100 us, Duty Cycle = 10%

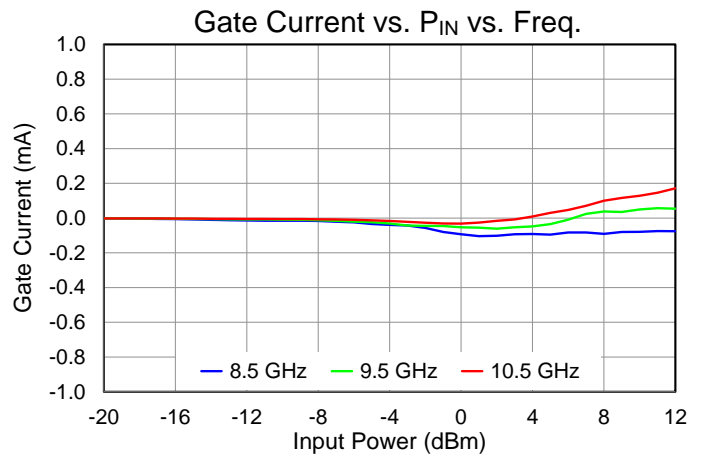
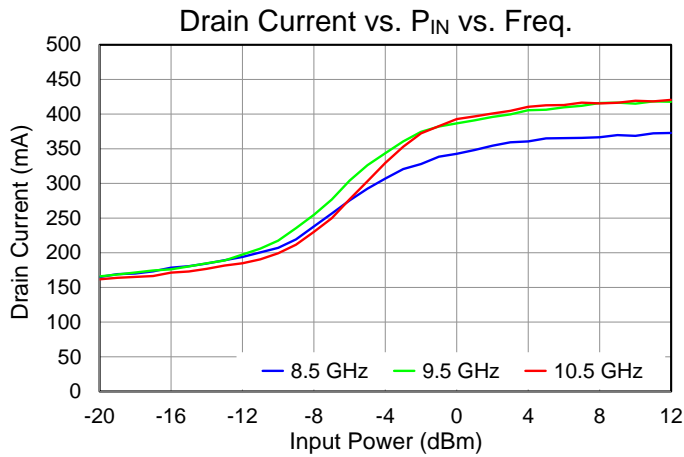
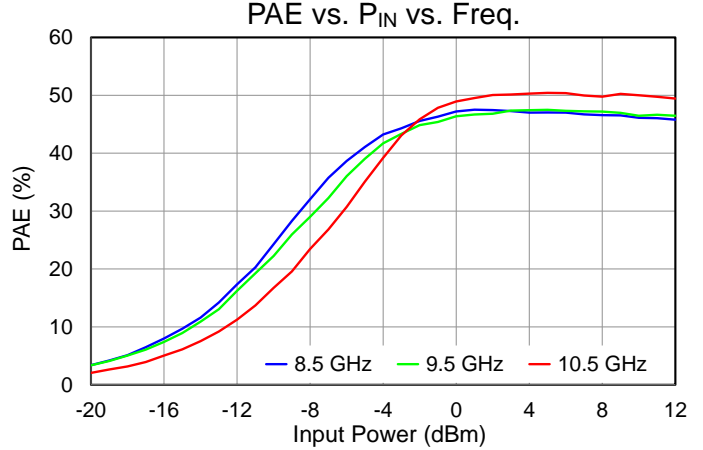
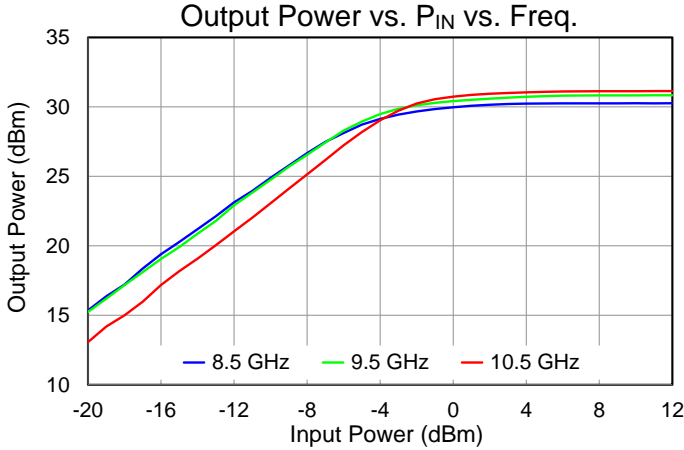

Performance Plots – Large Signal (Pulsed)

Test conditions unless otherwise noted: T = +25 °C, VD = 6 V, IDQ = 156 mA, Pulse Width = 100 us, Duty Cycle = 10%

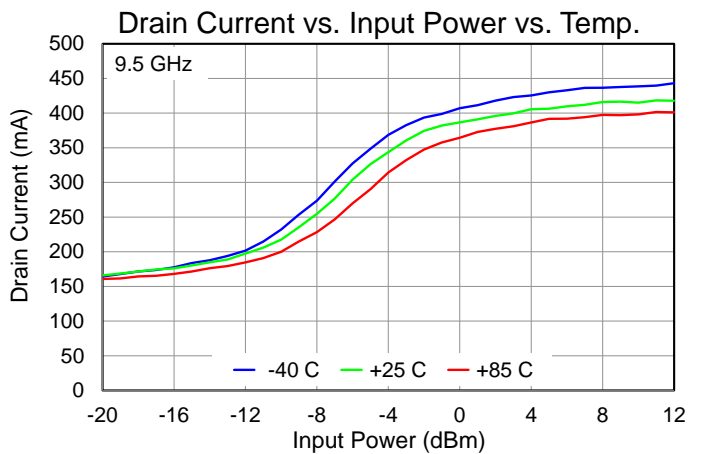
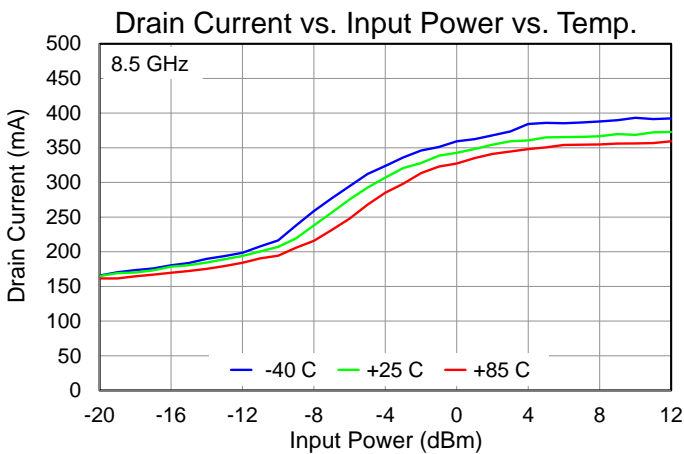
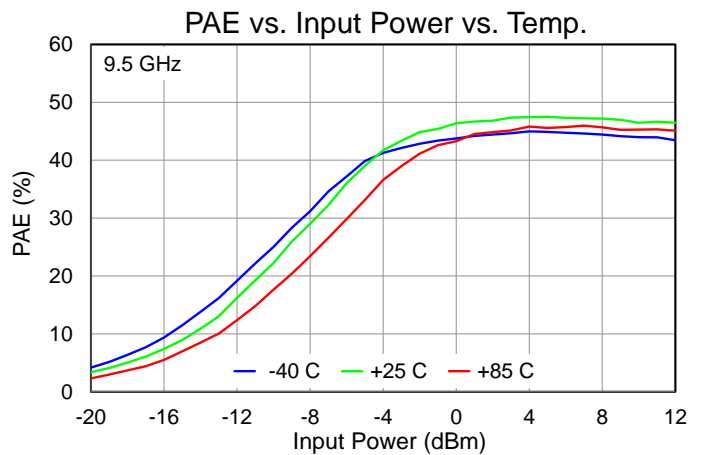
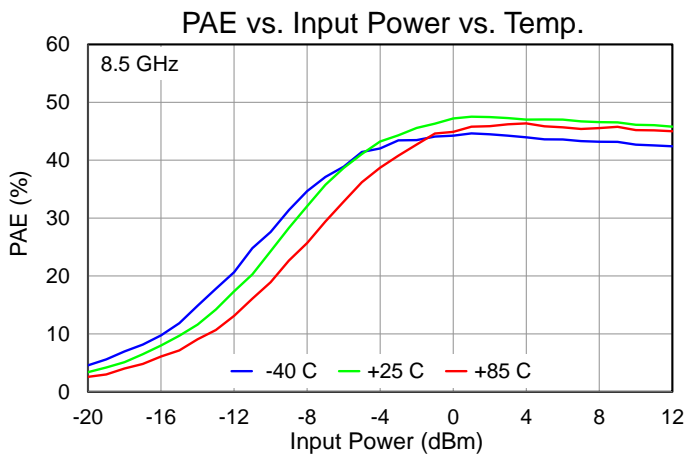
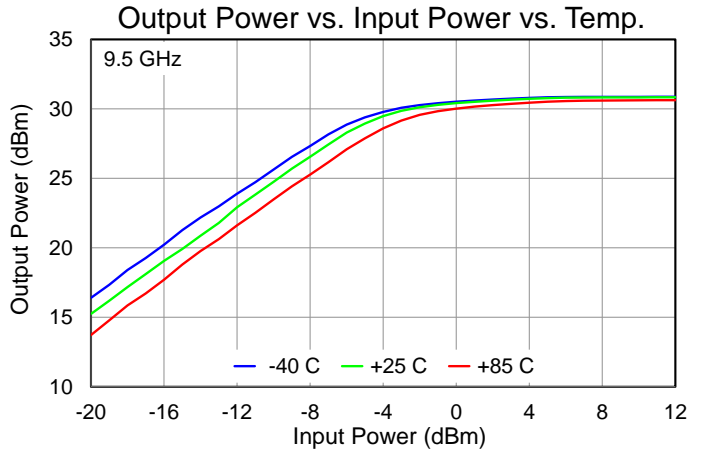
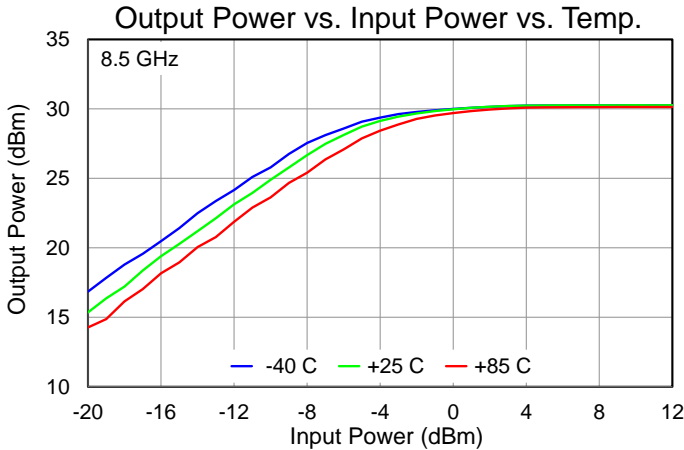

Performance Plots – Large Signal (Pulsed)

Test conditions unless otherwise noted: T = +25 °C, VD = 6 V, IDQ = 156 mA, Pulse Width = 100 us, Duty Cycle = 10%

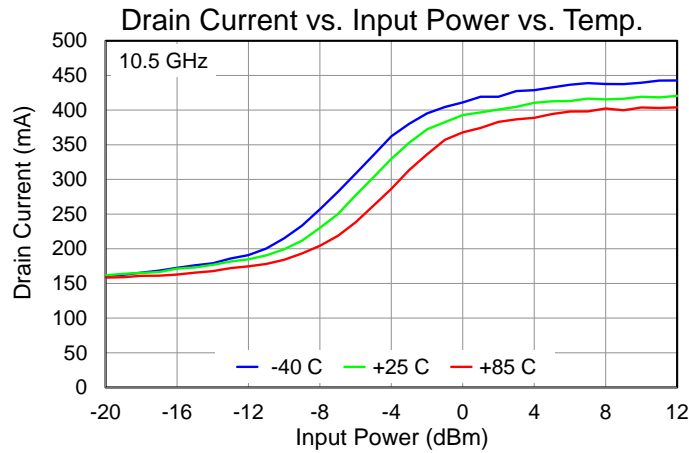
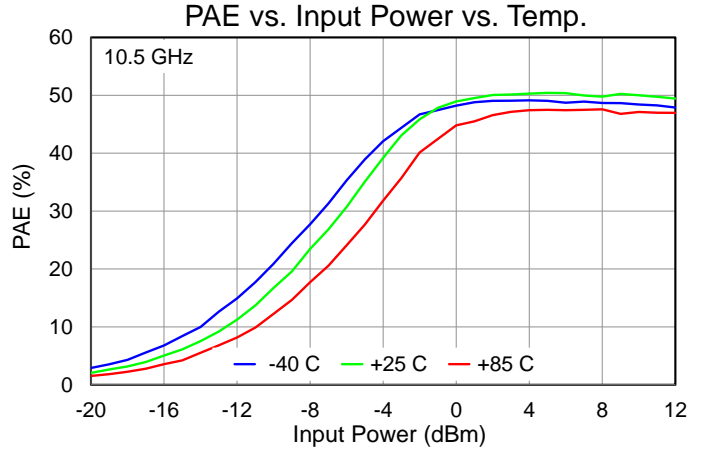
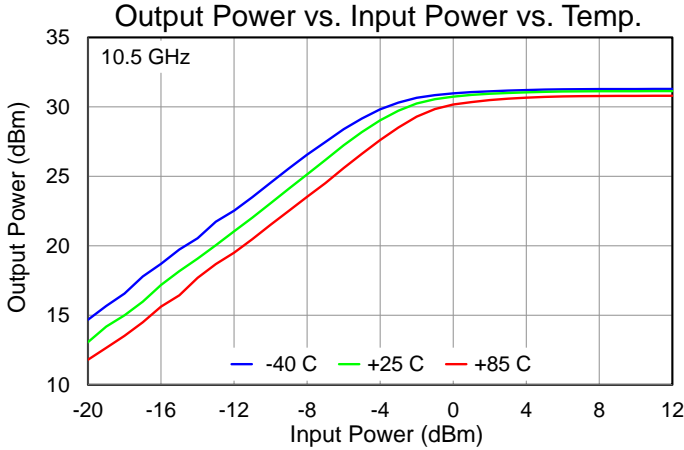

Performance Plots – Large Signal (Pulsed)

Test conditions unless otherwise noted: T = +25 °C, VD = 6 V, IDQ = 156 mA, Pulse Width = 100 us, Duty Cycle = 10%

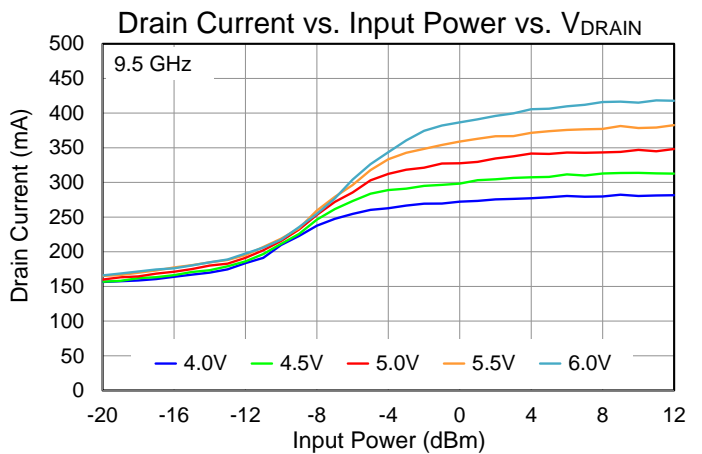
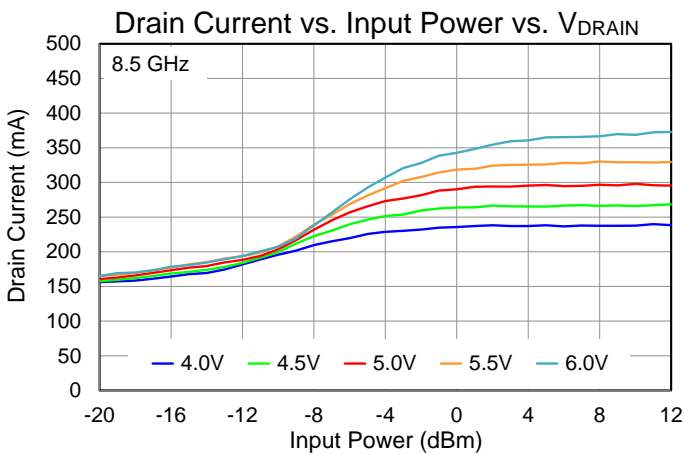
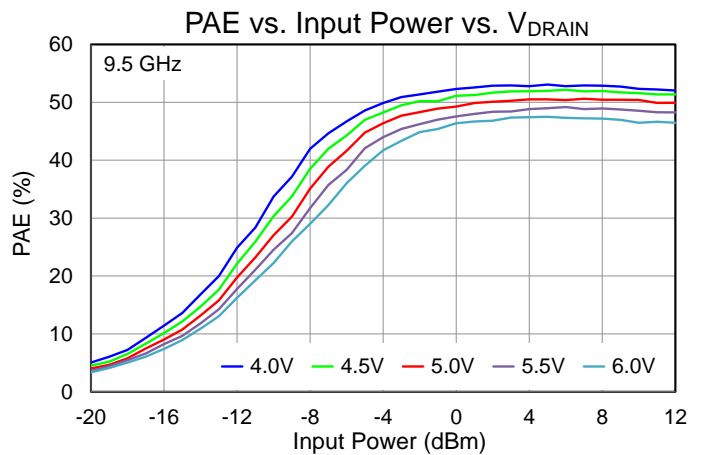
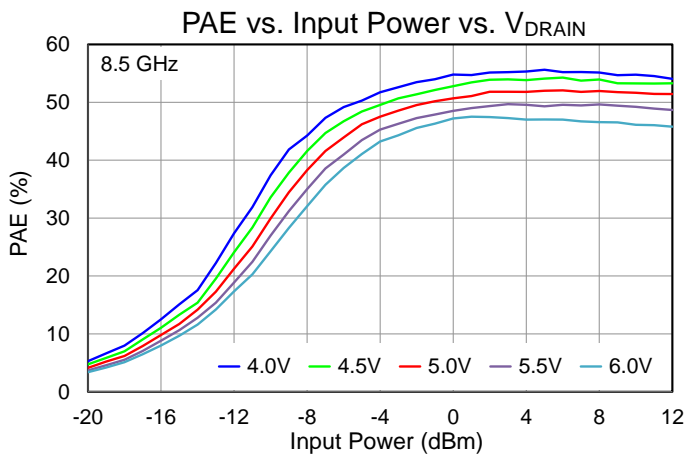
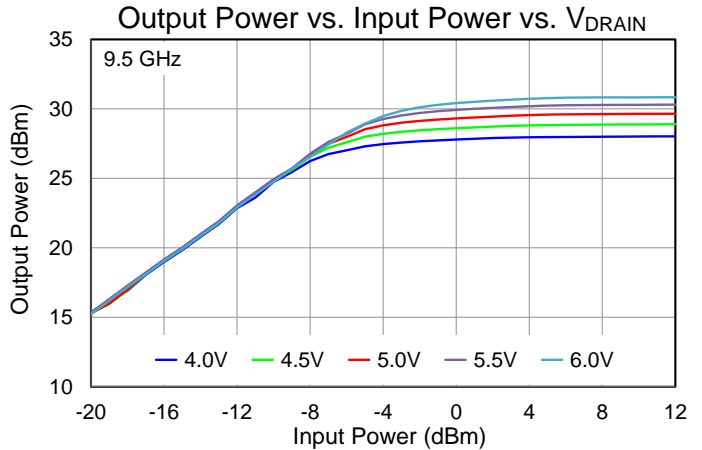
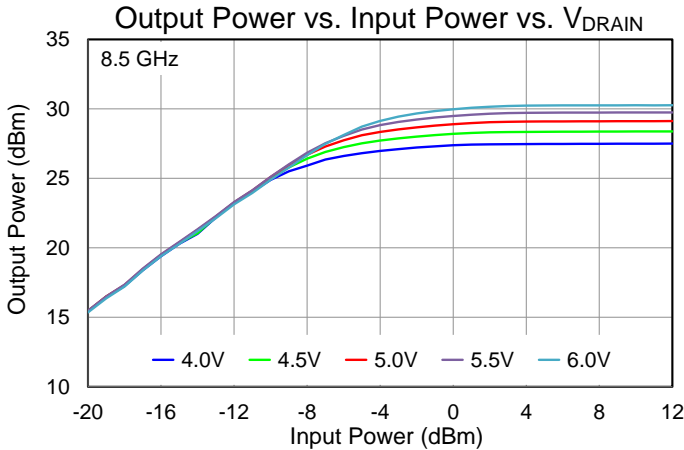

Performance Plots – Large Signal (Pulsed)

Test conditions unless otherwise noted: T = +25 °C, VD = 6 V, IDQ = 156 mA, Pulse Width = 100 us, Duty Cycle = 10%

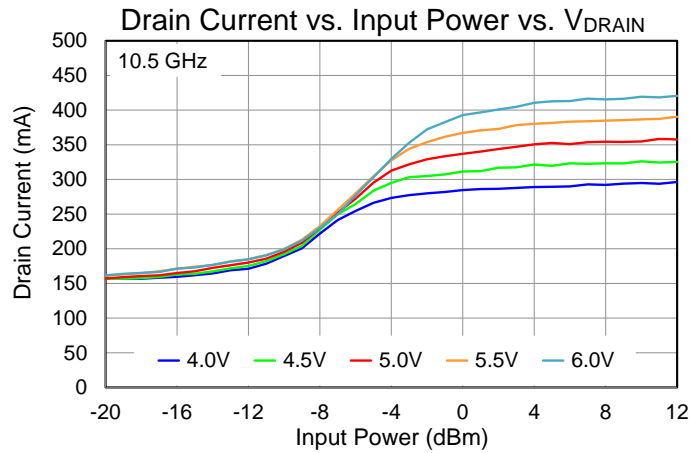
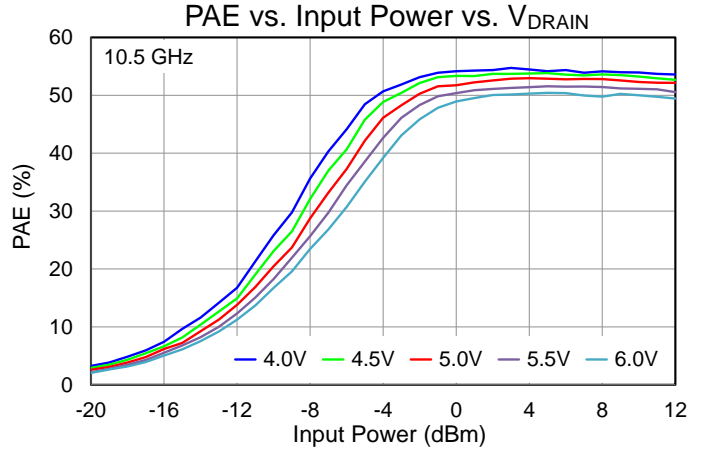
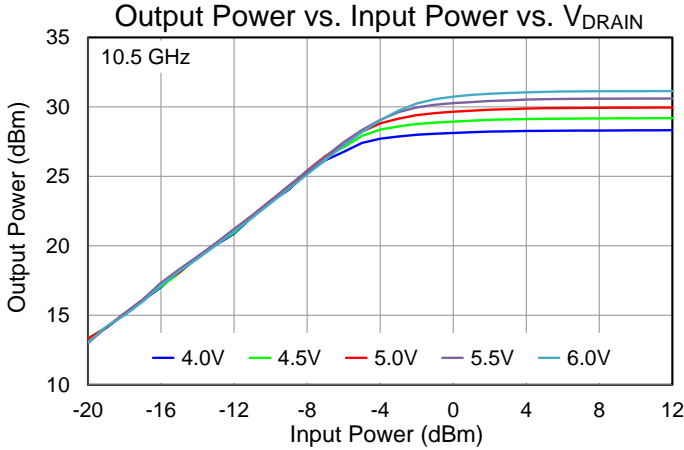

Performance Plots – Large Signal (Pulsed)

Test conditions unless otherwise noted: T = +25 °C, VD = 6 V, IDQ = 156 mA, Pulse Width = 100 us, Duty Cycle = 10%

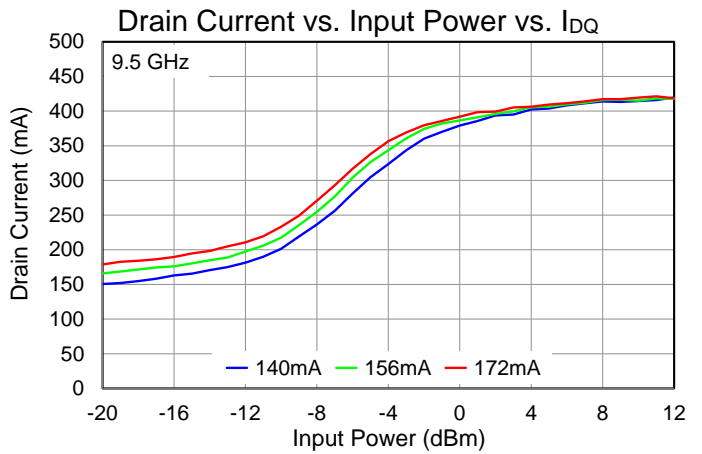
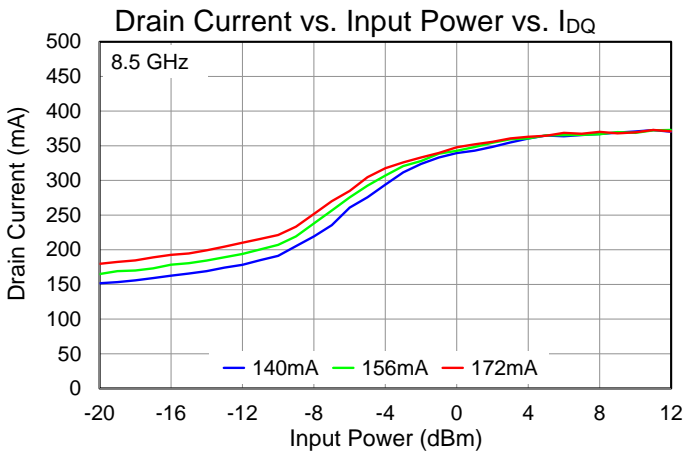
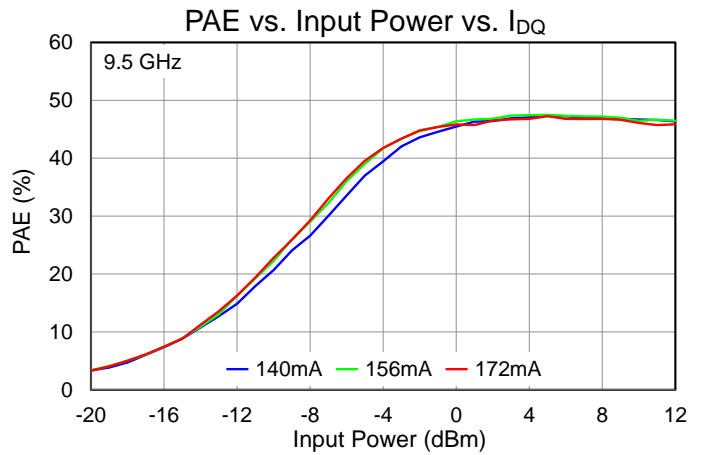
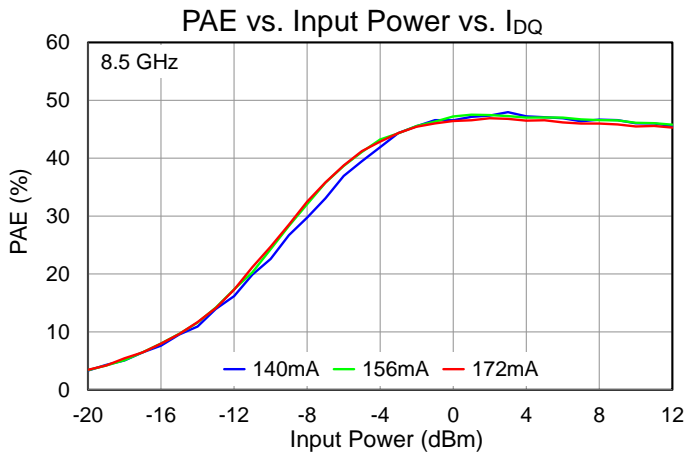
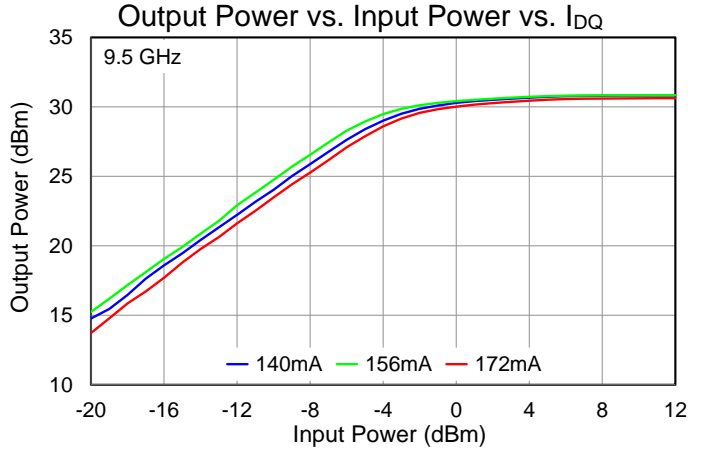
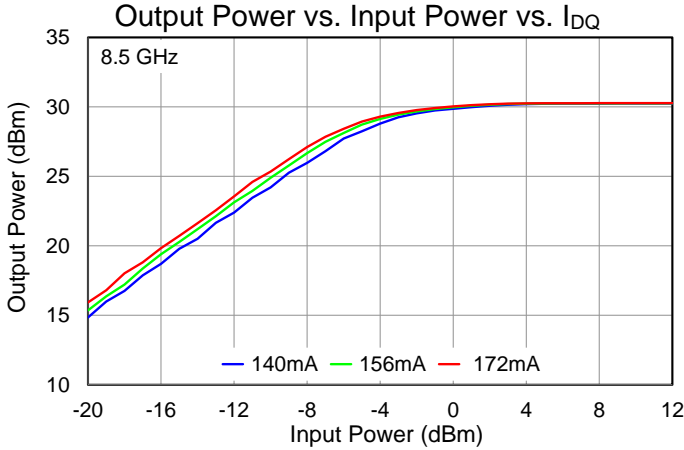

Performance Plots – Large Signal (Pulsed)

Test conditions unless otherwise noted: T = +25 °C, VD = 6 V, IDQ = 156 mA, Pulse Width = 100 us, Duty Cycle = 10%

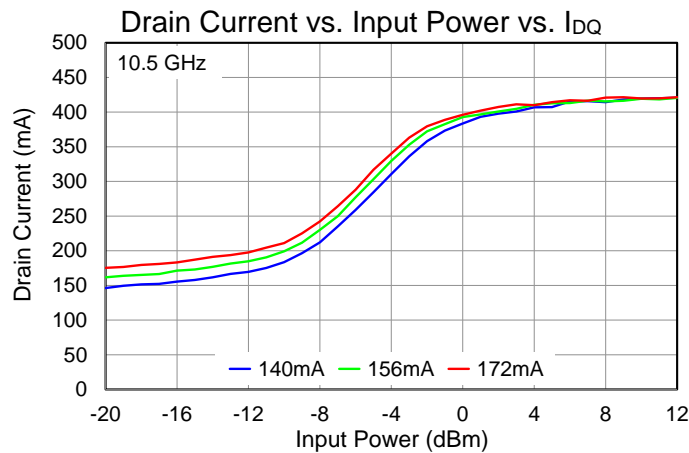
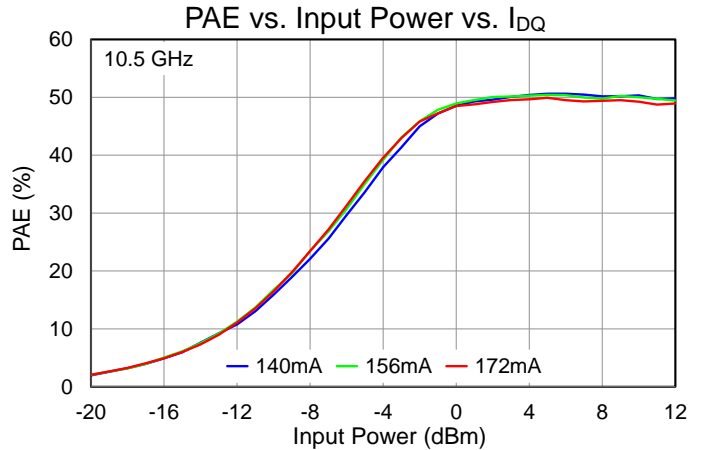
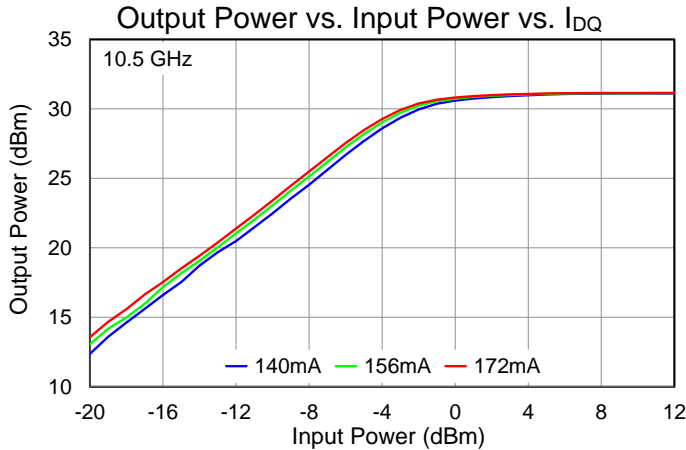

Performance Plots – Linearity

Test conditions unless otherwise noted: $V_D = 6\text{ V}$, $I_{DQ} = 156\text{ mA}$, $T = 25\text{ }^\circ\text{C}$, CW

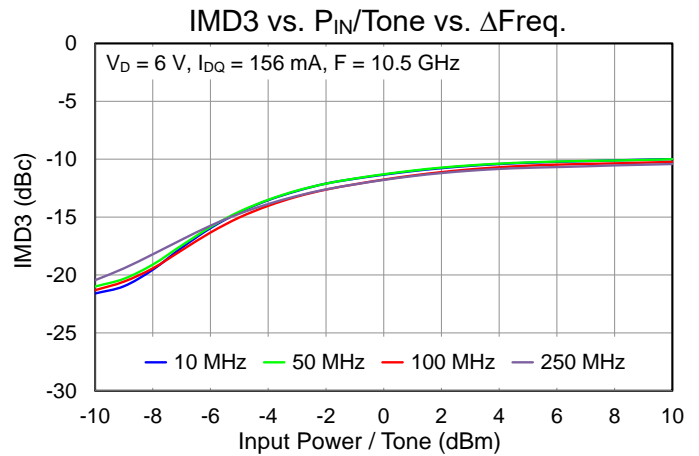
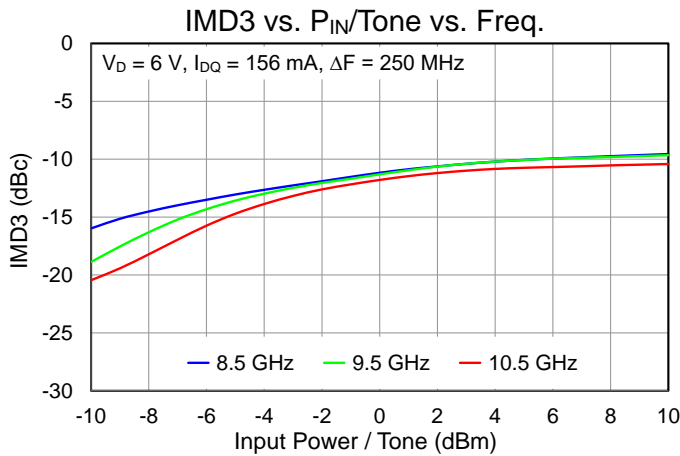
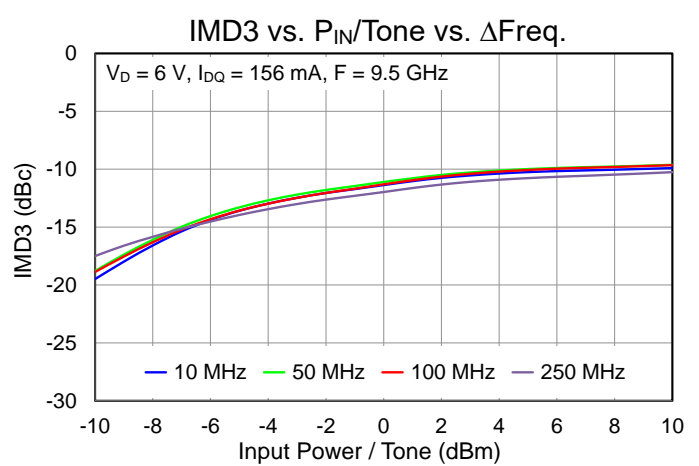
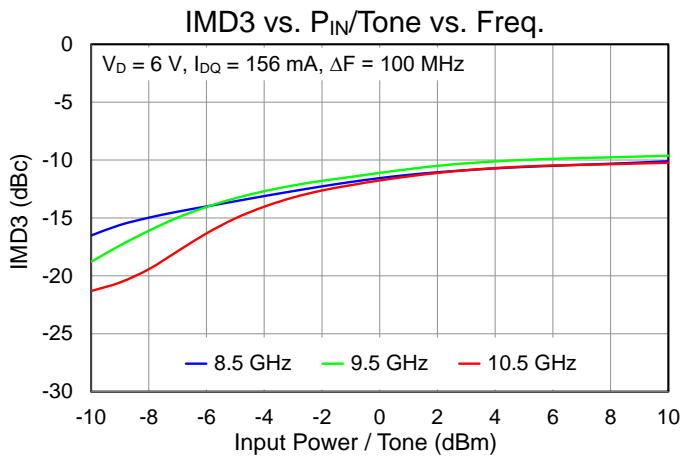
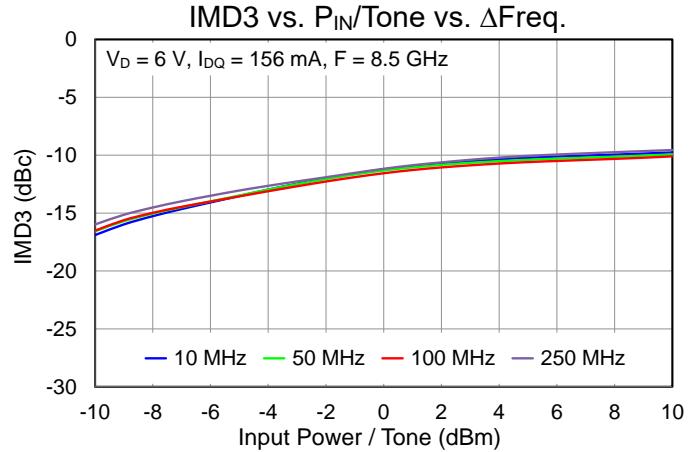
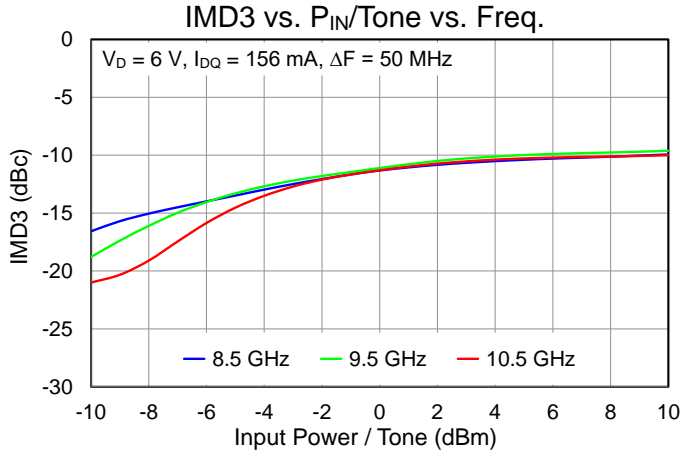

Performance Plots – Harmonics

Test conditions unless otherwise noted: T = +25 °C, VD = 6 V, IDQ = 156 mA, Pulse Width = 100 us, Duty Cycle = 10%

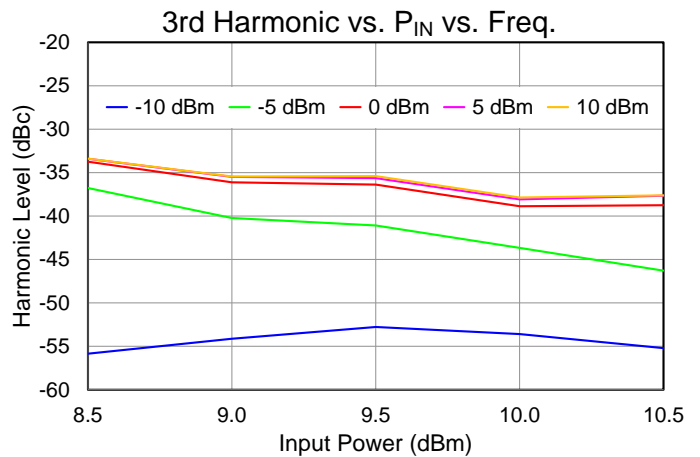
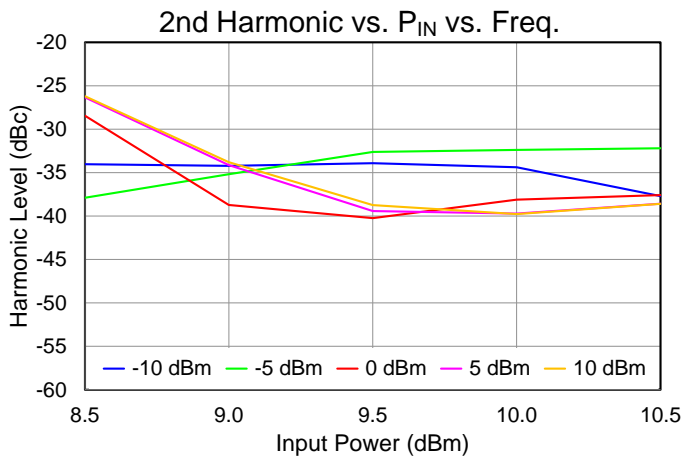
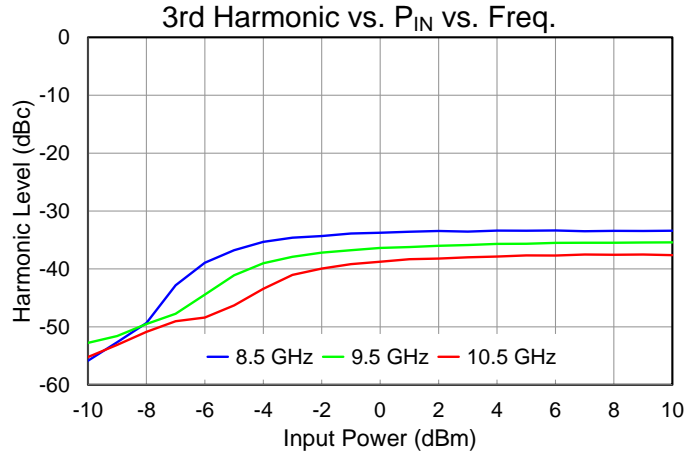
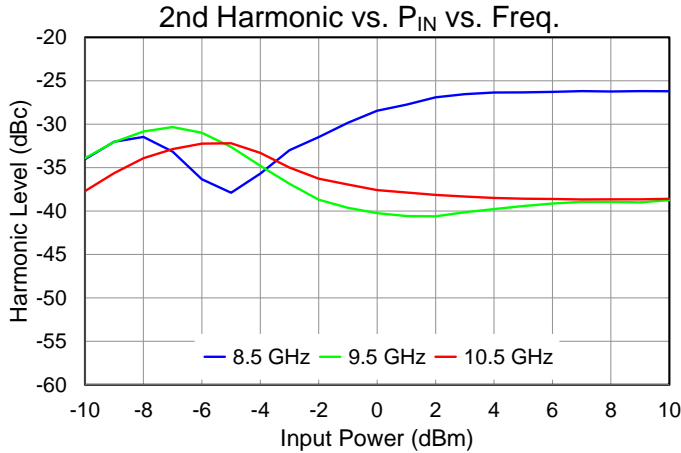

Performance Plots – Small Signal

Test conditions unless otherwise noted: T = +25 °C, VD = 6 V, IDQ = 156 mA, CW

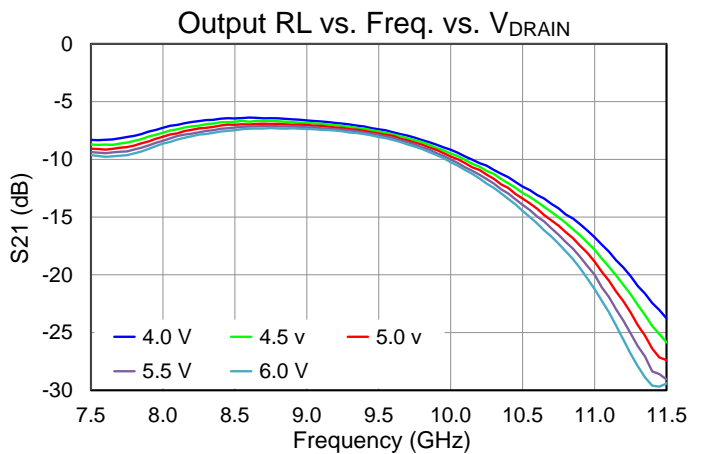
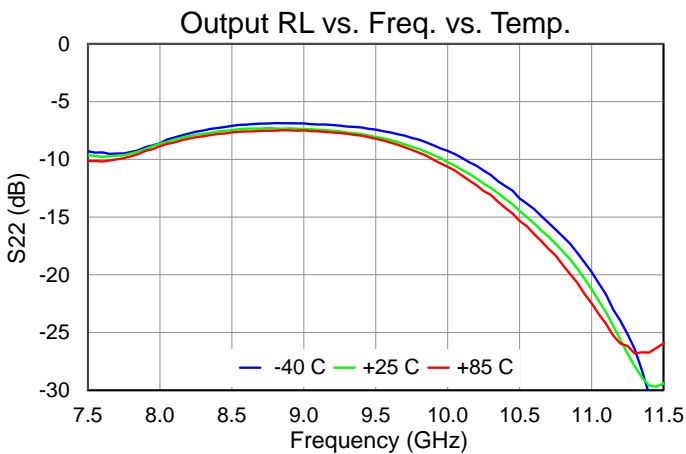
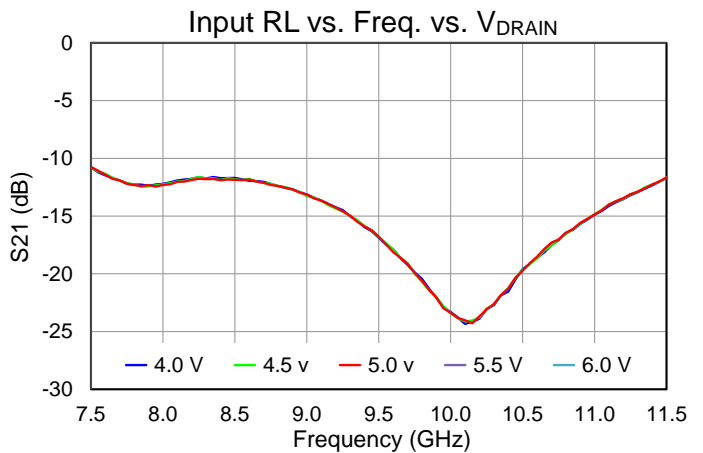
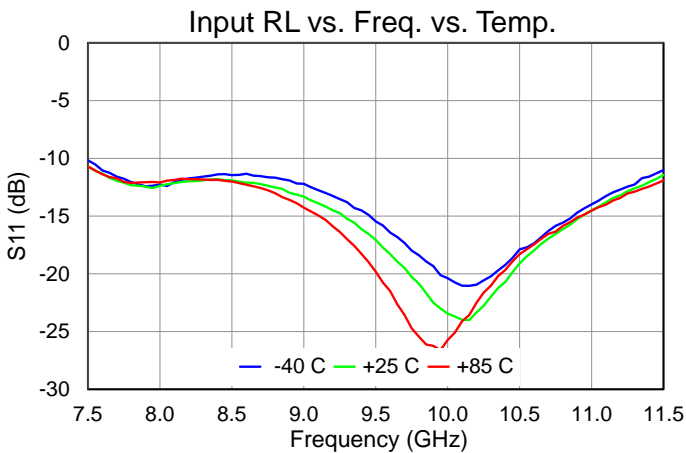
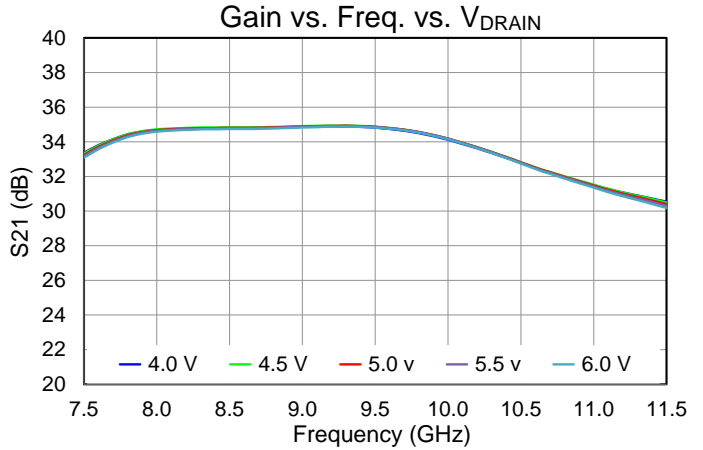
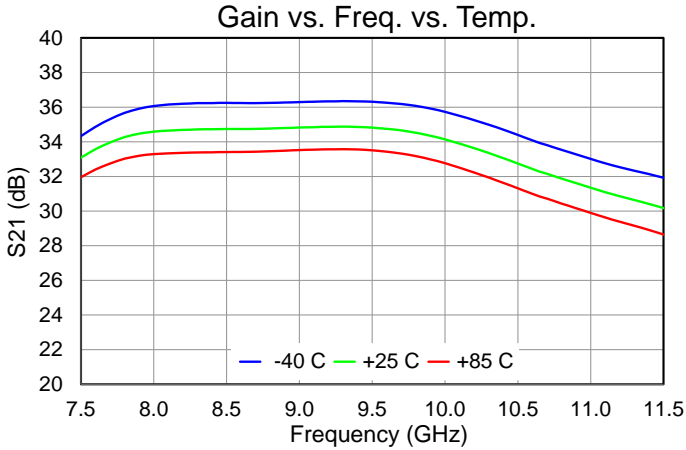

Performance Plots – Small Signal

Test conditions unless otherwise noted: T = +25 °C, VD = 6 V, IDQ = 156 mA, CW

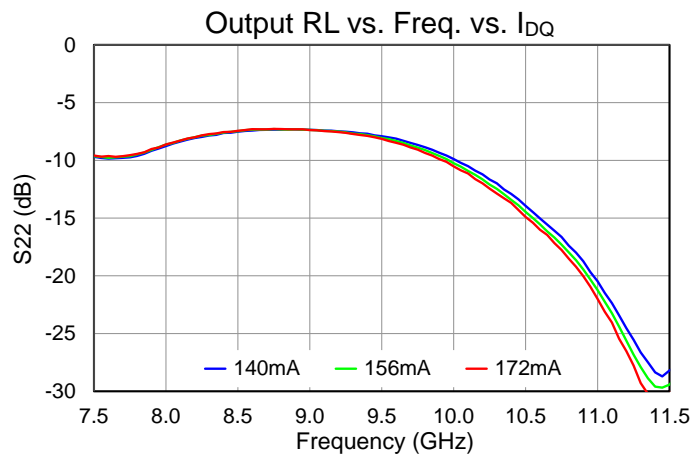
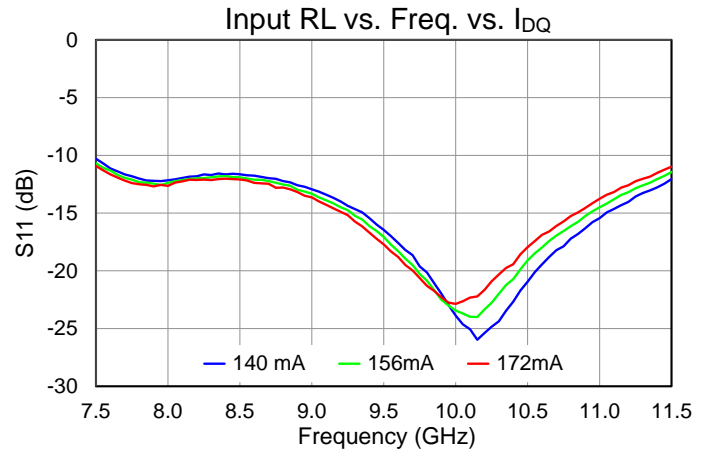
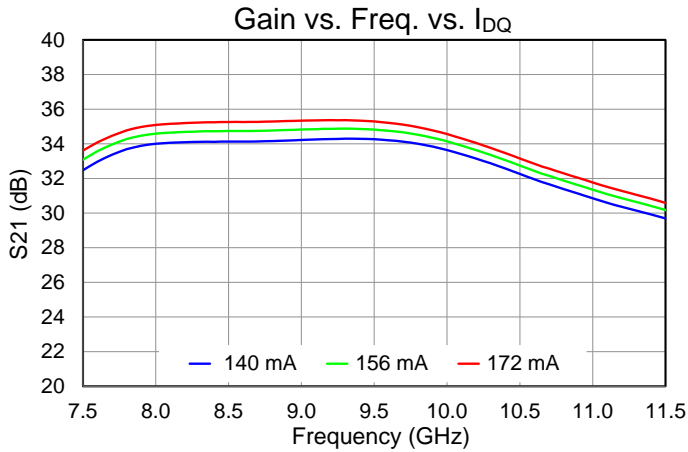

Thermal and Reliability Information

Parameter	Test Conditions	Value	Units
Thermal Resistance (θ_{JC}) ⁽¹⁾	$T_{base} = +85\text{ }^{\circ}\text{C}$, $V_D = 6\text{ V}$, $I_{DQ} = 156\text{ mA}$, DC Power, $P_{DISS} = 0.936\text{ W}$ (quiescent, no RF)	33.61	$^{\circ}\text{C}/\text{W}$
Channel Temperature, T_{CH} (Under RF) ⁽²⁾		131.7	$^{\circ}\text{C}$
Thermal Resistance (θ_{JC}) ⁽¹⁾	$T_{base} = +85\text{ }^{\circ}\text{C}$, $V_D = 6\text{ V}$, $I_{DQ} = 156\text{ mA}$, $I_{D_Drive} = 415\text{ mA}$, $P_{OUT} = 30.8\text{ dBm}$, $P_{IN} = 6\text{ dBm}$, Freq. = 10.0 GHz, $P_{DISS} = 1.39\text{ W}$ (Pulse: 100us/10%)	32.97	$^{\circ}\text{C}/\text{W}$
Channel Temperature, T_{CH} (Under RF) ⁽²⁾		89.4	$^{\circ}\text{C}$

Notes:

1. Thermal resistance is referenced to the back of the package.

Power Dissipation and Median Lifetime

$P_{IN} = 6\text{ dBm}$, Pulse Width = 100 us, Duty Cycle = 10%

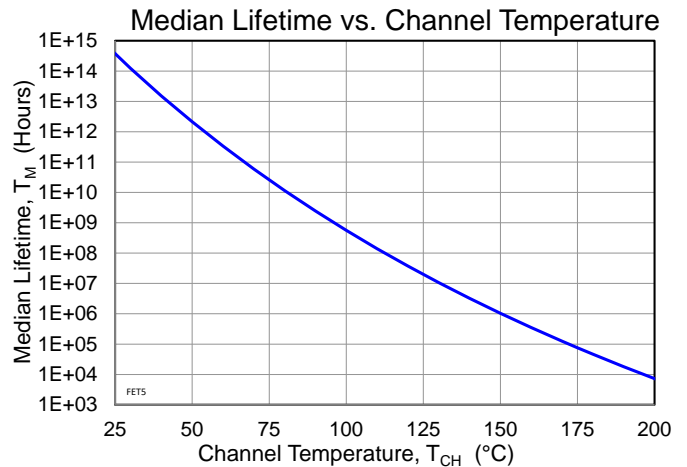
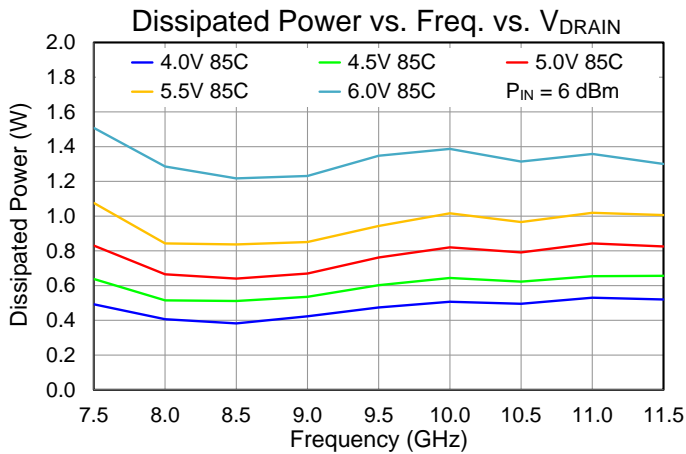

Application Information

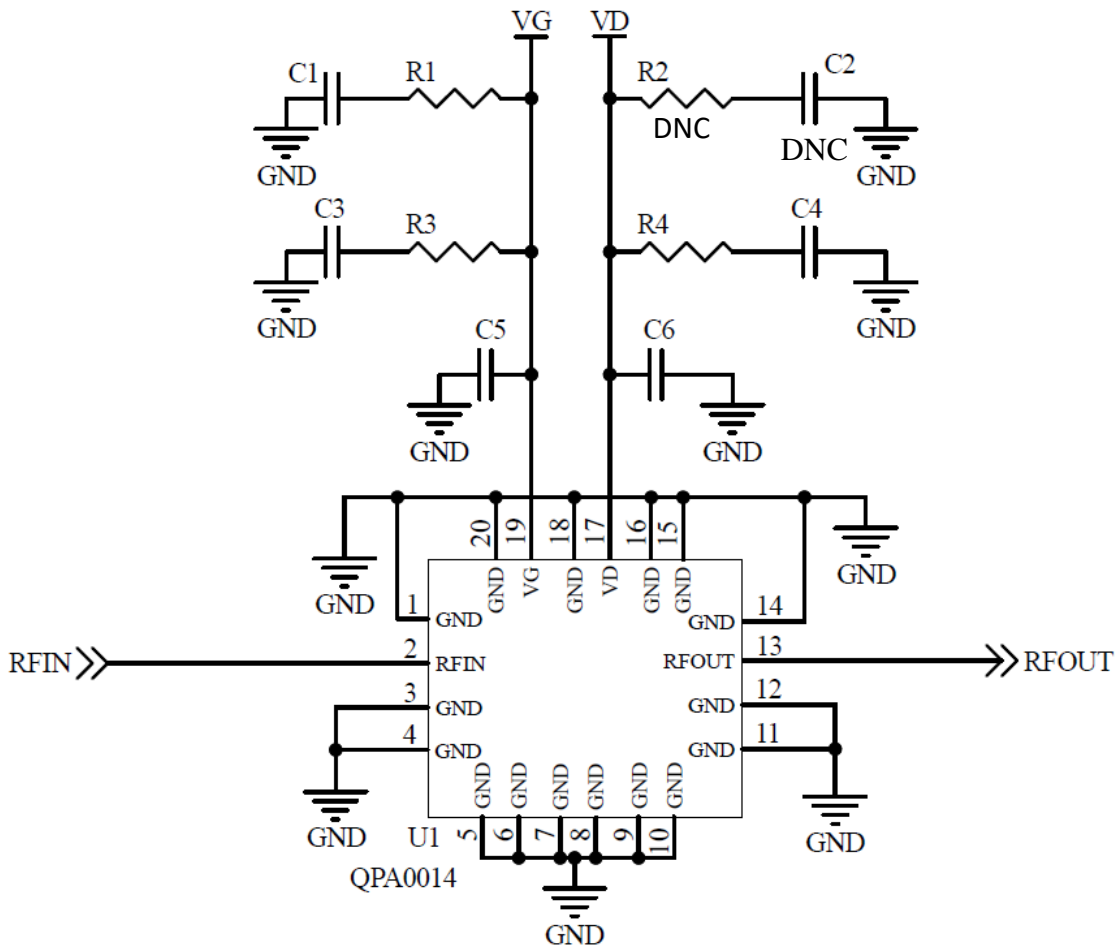

Bias-up Procedure

- Set I_D limit to 60 mA, I_G limit to 5 mA
- Apply -1.5 V to V_G
- Apply $+6$ V to V_D ; ensure I_{DQ} is approx. 0 mA
- Adjust V_G until $I_{DQ} = 156$ mA
- Turn on RF supply

Bias-down Procedure

- Turn off RF signal
- Reduce V_G to -1.5 V; ensure I_{DQ} is approx. 0 mA
- Set V_D to 0 V
- Turn off V_D supply
- Turn off V_G supply

Pin Layout

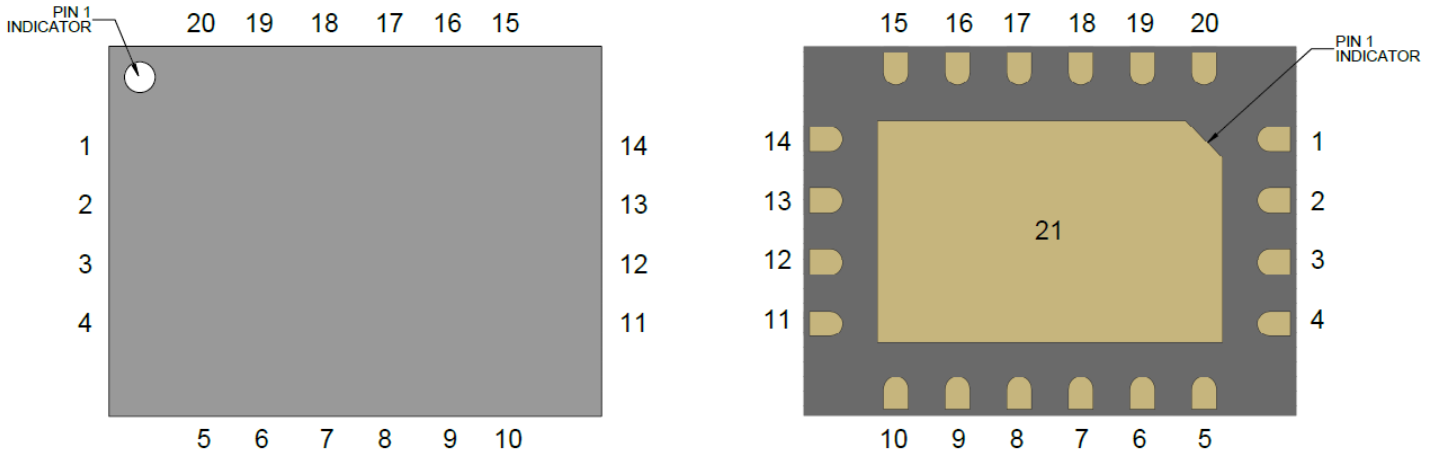

Pin Description

Pin Number	Symbol	Description
1, 3-12, 14-16, 18, 20	NC	No connection inside of package. Connection to PCB ground recommended
2	RF IN	RF input. 50 Ω , DC blocked
13	RF OUT	RF output. 50 Ω , DC blocked
17	VD	Drain voltage. Bypass network required; refer to page 17
19	VG	Gate voltage. Bypass network required; refer to page 17
21	GND	Center paddle ground

Evaluation Board

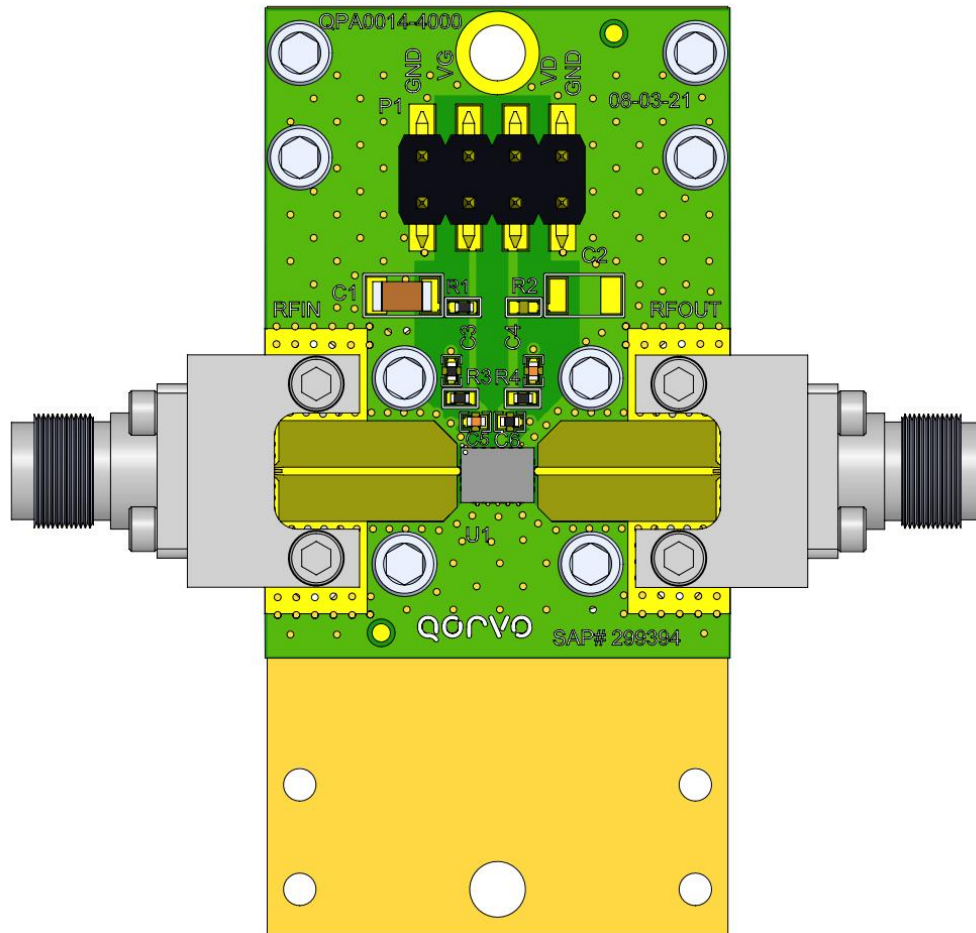

Bill of Materials

Ref. Des.	Value	Description	Manuf.	Part Number
C1	10 uF	CAP, 10uF, 20%, 50V, 20%, X5R, 1206	various	
C5,C6	1000 pF	CAP, 1000pF, 10%, 100V, X7R, 0402	various	
C3,C4	0.1 uF	CAP, 0.1uF, 10%, 50V, X7R, 0402	various	
R3,R4	0 Ω	RES, 0 OHM, JMPR, 0402	various	
R1	10 Ω	RES, 10 OHM, 5%, 0.1W, 0402	various	
J1, J2		2.92mm Female End Launch Connector	Southwest Microwave	1092-01A-5

Mechanical Information

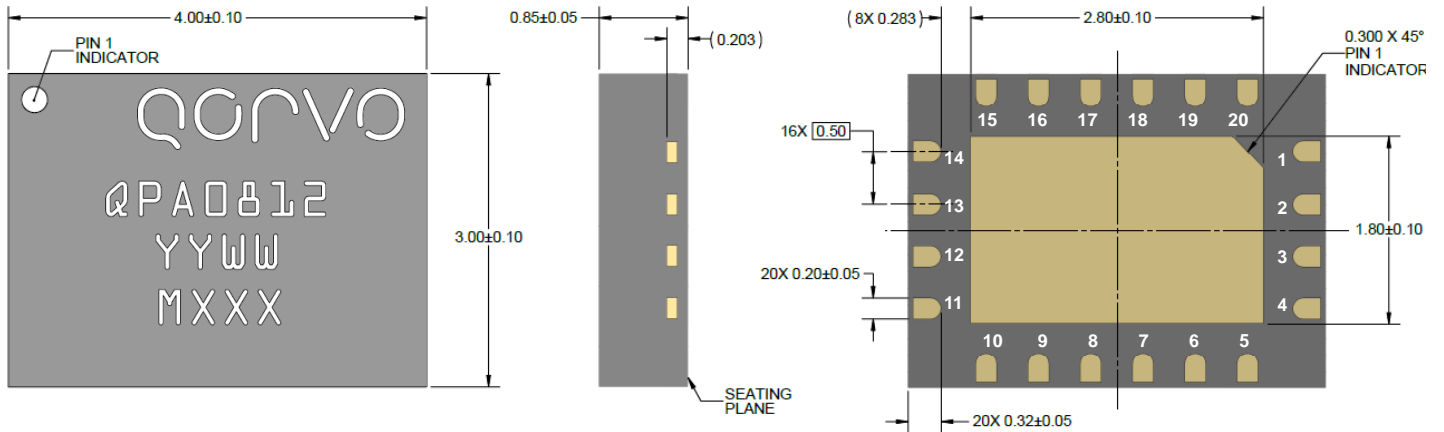

NOTES:

Package base and leads are Ni-Au plated

Part is mold encapsulated

Part Markings:

Part Number: QPA0812

Part Assembly Year: YY

Part Assembly Week: WW

Lot Number: MXXX

Dimensions are in millimeters

Assembly Notes

Compatible with lead-free soldering processes with 260°C peak reflow temperature.

Contact plating: Ni-Au.

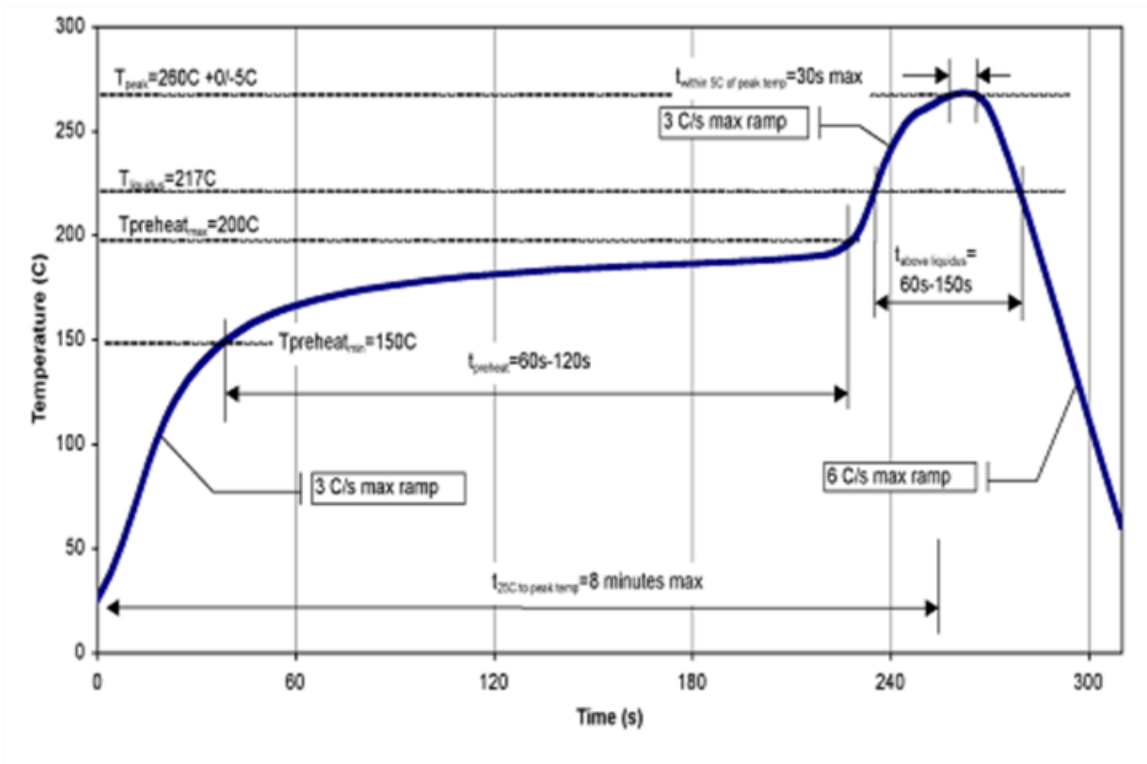

Recommended Soldering Temperature Profile

Tape and Reel Information – Carrier and Cover Tape Dimensions

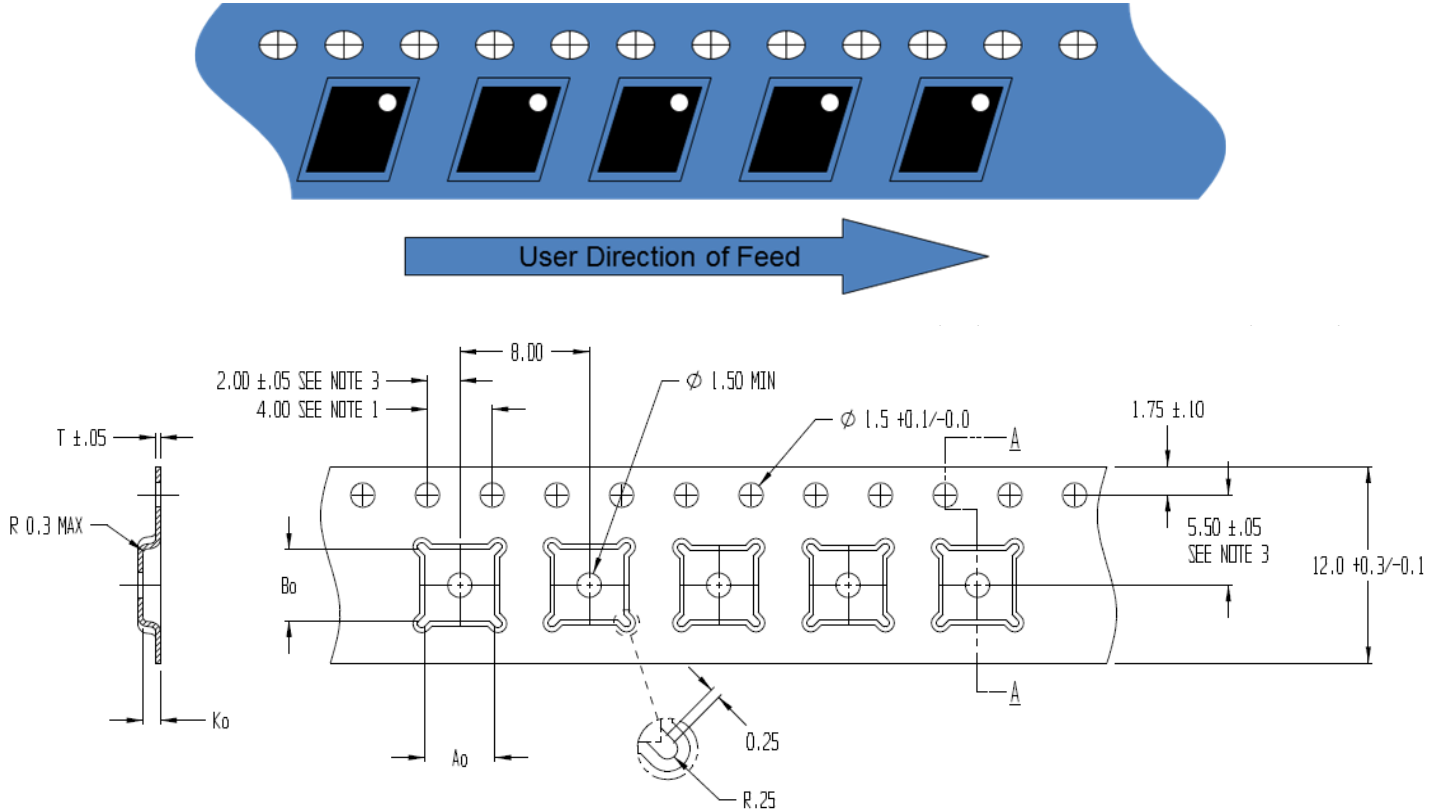

Feature	Measure	Symbol	Size (in)	Size (mm)
Cavity	Length	A0	0.126	3.20
	Width	B0	0.167	4.25
	Depth	K0	0.047	1.20
	Pitch	P1	0.315	8.00
Centerline Distance	Cavity to Perforation - Length Direction	P2	0.079	2.00
	Cavity to Perforation - Width Direction	F	0.217	5.50
Cover Tape	Width	C	0.362	9.20
Carrier Tape	Width	W	0.472	12.00

Tape and Reel Information – Reel Dimensions

Standard T/R size = 500 pieces on a 7" reel.

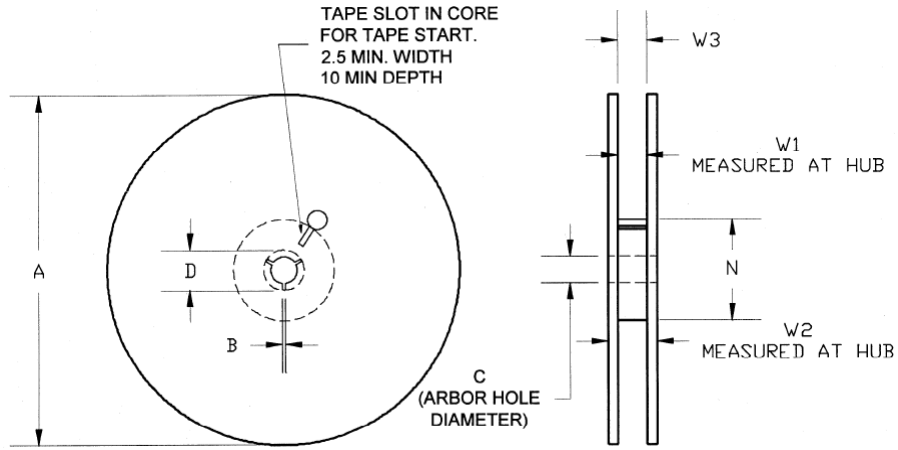

Feature	Measure	Symbol	Size (in)	Size (mm)
Flange	Diameter	A	6.969	177.0
	Thickness	W2	0.724	18.4
	Space Between Flange	W1	0.488	12.4
Hub	Outer Diameter	N	2.283	58.0
	Arbor Hole Diameter	C	0.512	13.0
	Key Slit Width	B	0.079	2.0
	Key Slit Diameter	D	0.795	20.2

Tape and Reel Information – Tape Length and Label Placement

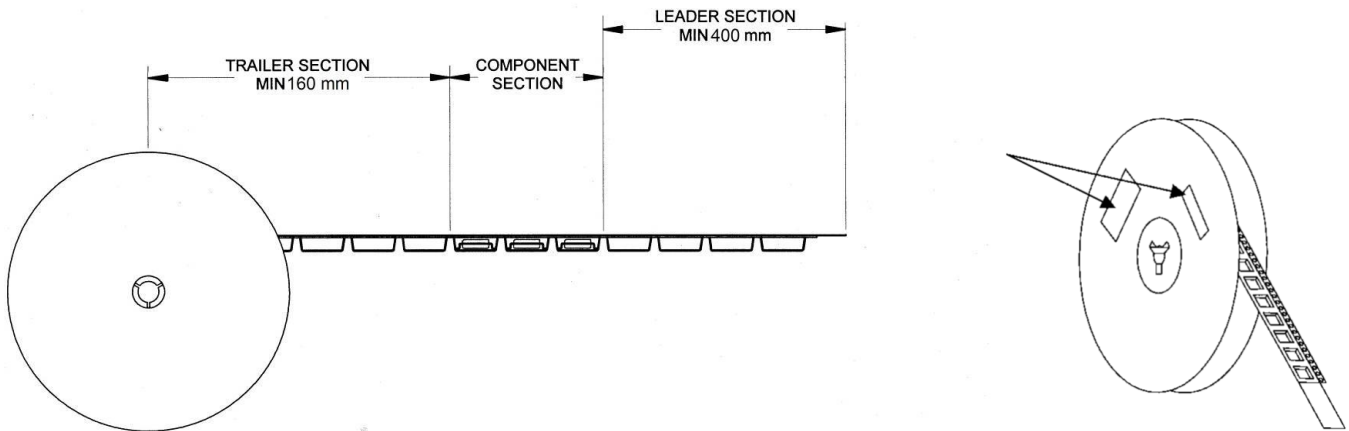

- Notes:
1. Empty part cavities at the trailing and leading ends are sealed with cover tape. See EIA 481-1-A.
 2. Labels are placed on the flange opposite the sprockets in the carrier tape.