

### Product Description

Qorvo's QPA1014 is a high-power, S-band MMIC amplifier fabricated on Qorvo's 0.25um GaN on SiC production process (QGaN25). Covering 2.7 – 3.7 GHz, the QPA1014 provides 40 W of saturated output power with 24 dB large signal gain and 48% power-added efficiency.

The QPA1014 is packaged in a plastic overmold QFN with a pure Cu paddle offering easy handling with good thermal properties. As a result, the QPA1014 has bias flexibility allowing the user to vary the voltage to achieve optimum system performance while maintaining high reliability.

The QPA1014 is matched to 50 ohms with integrated DC blocking caps on both I/O ports. With the high performance, good thermal characteristics and ease of handling and system integration, the QPA1014 is ideal for use in both commercial and military radar systems.

Lead-free and RoHS compliant.

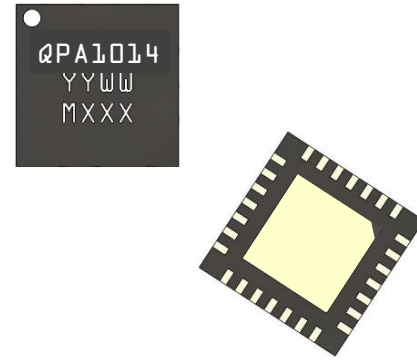

### Product Features

- Frequency Range: 2.7 – 3.7 GHz
- Pout: 46 dBm ( $P_{IN} = 22$  dBm)
- Large Signal Gain: 24 dB ( $P_{IN} = 22$  dBm)
- PAE: 48 % ( $P_{IN} = 22$  dBm)
- Bias:  $V_D = 28$  V,  $I_{DQ} = 450$  mA,  $V_G = -2.7$  V (Typ)
- Supports Long Pulse Operation
- Package Dimensions: 6.0 x 6.0 x 0.85 mm

*Performance is typical across frequency. Please reference electrical specification table and data plots for more details.*

### Functional Block Diagram

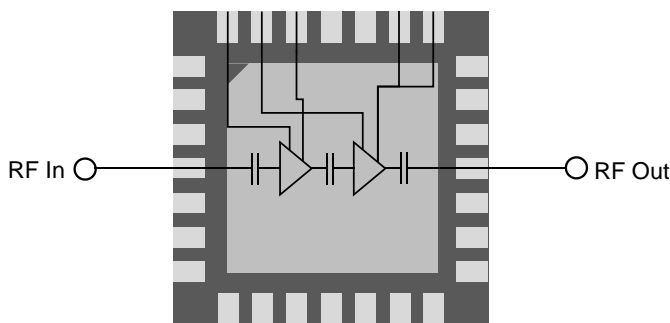

### Applications

- Military Radar
- Commercial Radar

### Ordering Information

Part	Description
QPA1014	2.7–3.7 GHz 30 W GaN Power Amplifier
QPA1014S2	Sample Box of 2
QPA1014PCB4B02	QPA1014 Eval Board

### Electrical Specifications

Test conditions, unless otherwise noted: 25 °C,  $V_D = 28$  V,  $I_{DQ} = 450$  mA, Pulse Width = 100 us, Duty Cycle = 10%

Parameter		Min	Typ	Max	Units
Operational Frequency Range		2.7		3.7	GHz
Output Power ( $P_{IN} = 22$ dBm)	Frequency = 2.7 GHz		45.9		dBm
	Frequency = 3.1 GHz		46.2		
	Frequency = 3.7 GHz		45.5		
Power Added Efficiency ( $P_{IN} = 22$ dBm)	Frequency = 2.7 GHz		48.1		%
	Frequency = 3.1 GHz		53.2		
	Frequency = 3.7 GHz		51.1		
Small Signal Gain	Frequency = 2.7 GHz		31.8		dB
	Frequency = 3.1 GHz		30.3		
	Frequency = 3.7 GHz		29.3		
Input Return Loss	Frequency = 2.7 GHz		13.5		dB
	Frequency = 3.1 GHz		25.5		
	Frequency = 3.7 GHz		7.5		
Output Return Loss	Frequency = 2.7 GHz		10.0		dB
	Frequency = 3.1 GHz		22.0		
	Frequency = 3.7 GHz		10.0		
2 <sup>nd</sup> Harmonic ( $P_{OUT} = 40$ dBm)	Frequency = 2.7 GHz		-17.5		dBc
	Frequency = 3.1 GHz		-29.5		
	Frequency = 3.5 GHz		-37.0		
3 <sup>rd</sup> Harmonic ( $P_{OUT} = 40$ dBm)	Frequency = 2.7 GHz		-54.5		dBc
	Frequency = 3.1 GHz		-62.0		
	Frequency = 3.5 GHz		-64.0		
Output Power Temperature Coefficient ( $P_{IN} = 22$ dBm)			-0.013		dBm/°C
Small Signal Gain Temperature Coefficient			-0.049		dB/°C

### Recommended Operating Conditions

Parameter	Value
Drain Voltage	28 V
Drain Current (quiescent, $I_{DQ}$ )	450 mA
Drain Current (under drive, $I_D$ )	3.7 A
Gate Voltage	-2.7 V
Operating Temperature Range	-40 to 85 °C

Electrical specifications are measured at specified test conditions. Specifications are not guaranteed over all recommended operating conditions.

### Performance Plots – Large Signal (Pulsed)

Test conditions unless otherwise noted: Temp. = 25 °C,  $V_D = 28$  V,  $I_{DQ} = 450$  mA, PW = 100 us, Duty Cycle = 10%

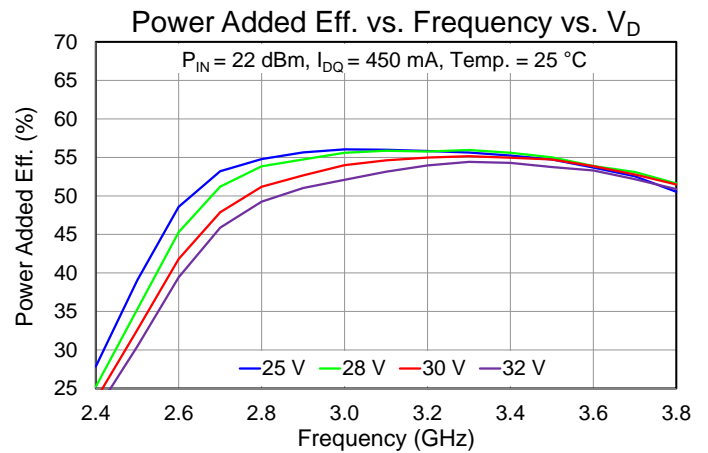
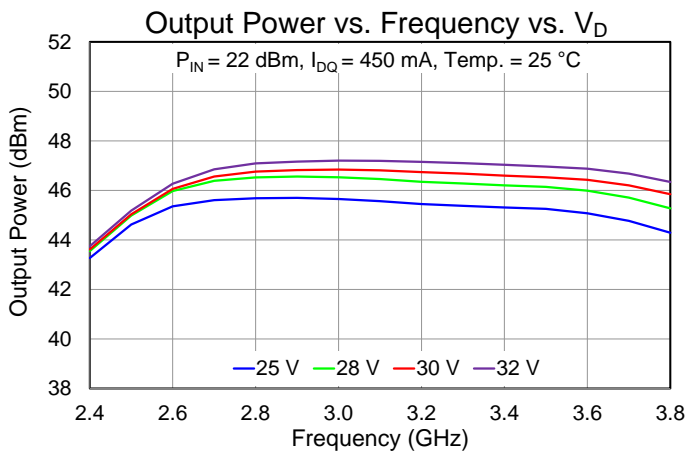
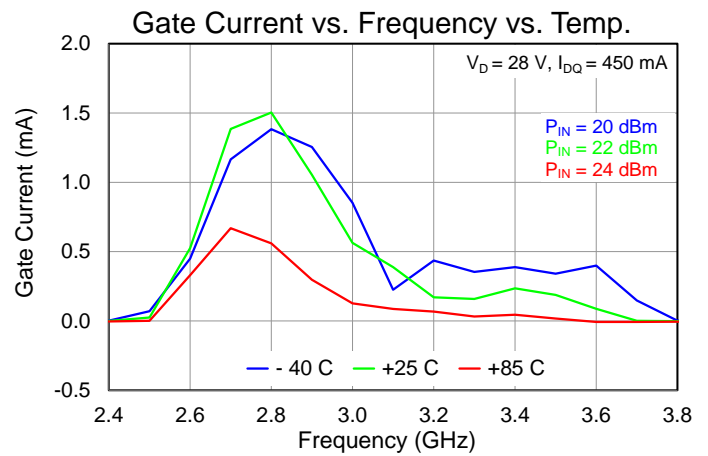
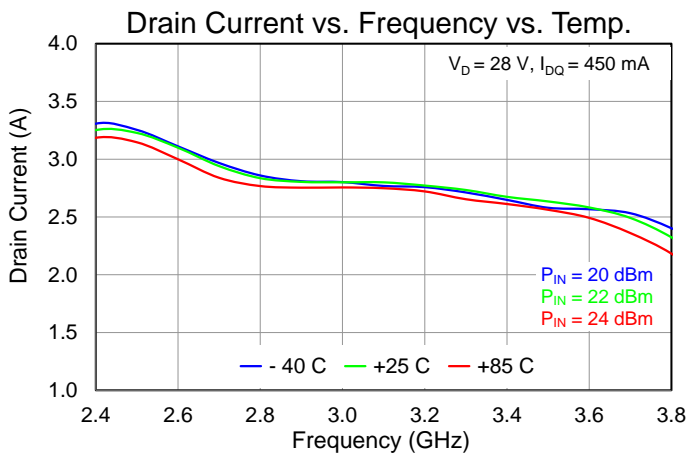
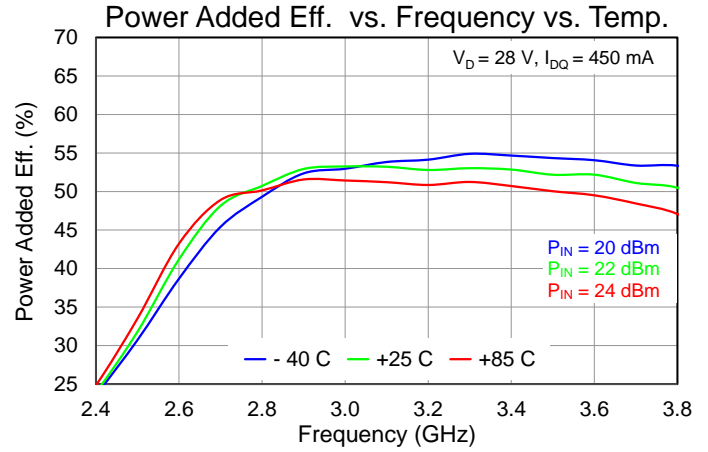
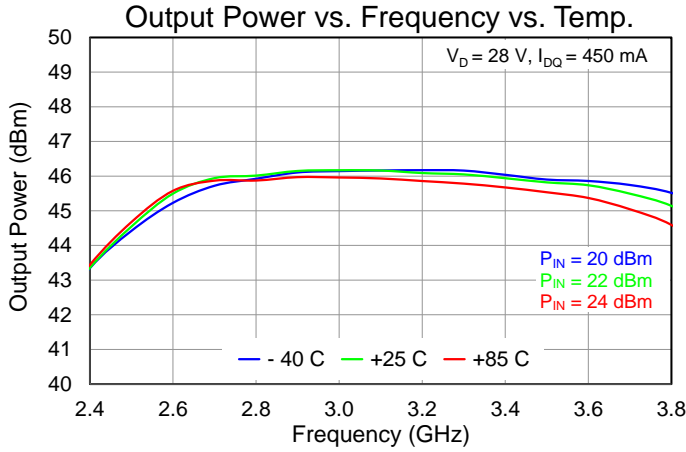

### Performance Plots – Large Signal (Pulsed)

Test conditions unless otherwise noted: Temp. = 25 °C,  $V_D = 28$  V,  $I_{DQ} = 450$  mA, PW = 100 us, Duty Cycle = 10%

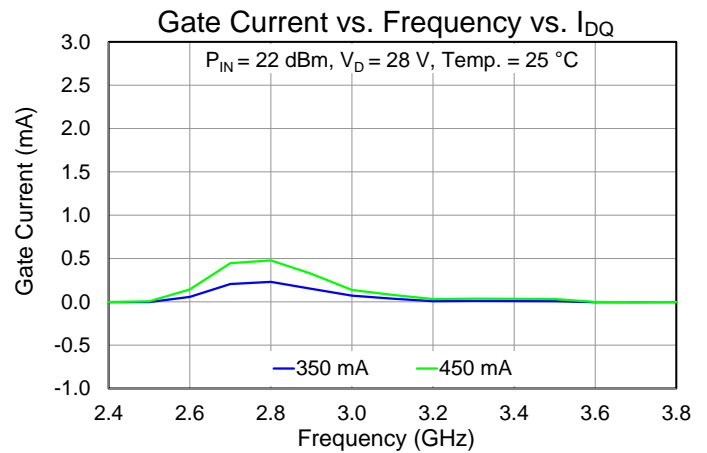
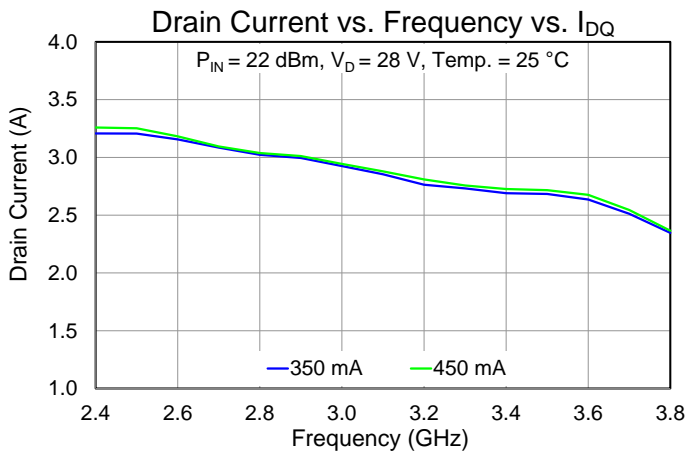
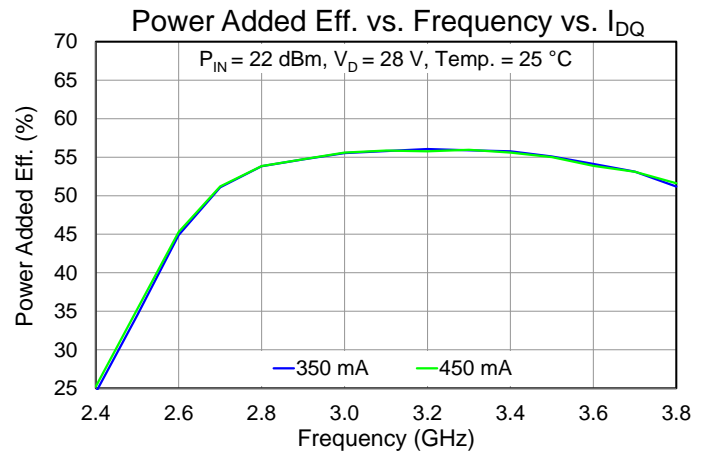
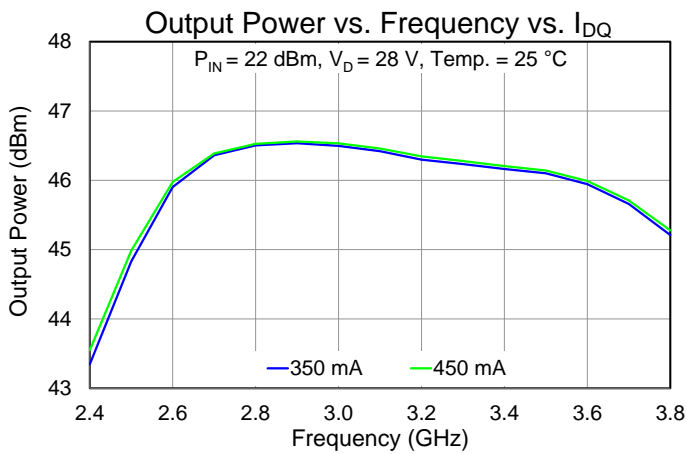
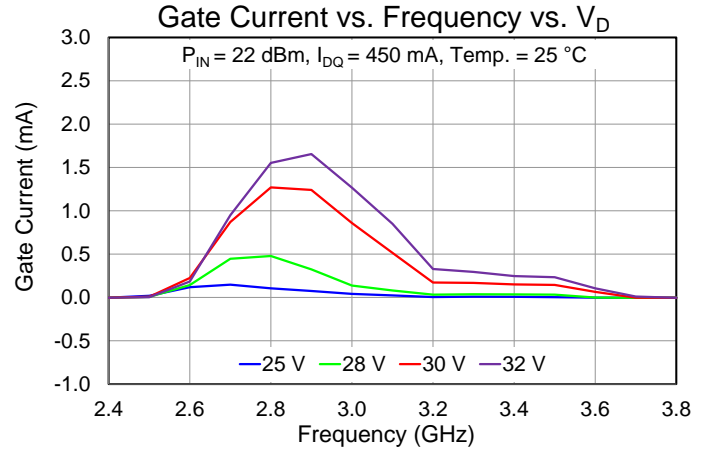
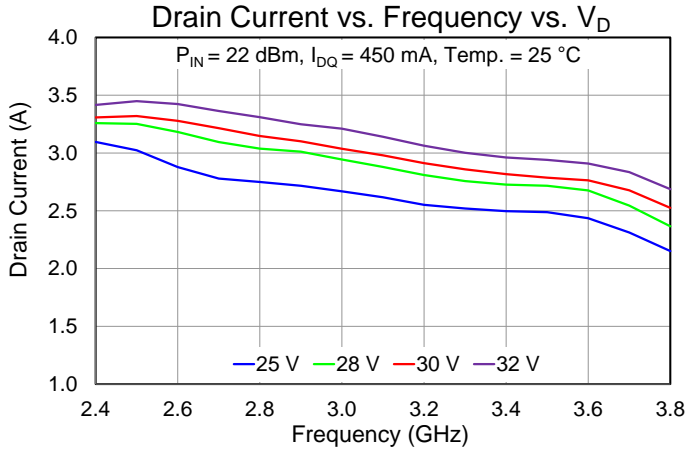

### Performance Plots – Large Signal (Pulsed)

Test conditions unless otherwise noted: Temp. = 25 °C,  $V_D = 28$  V,  $I_{DQ} = 450$  mA, PW = 100 us, Duty Cycle = 10%

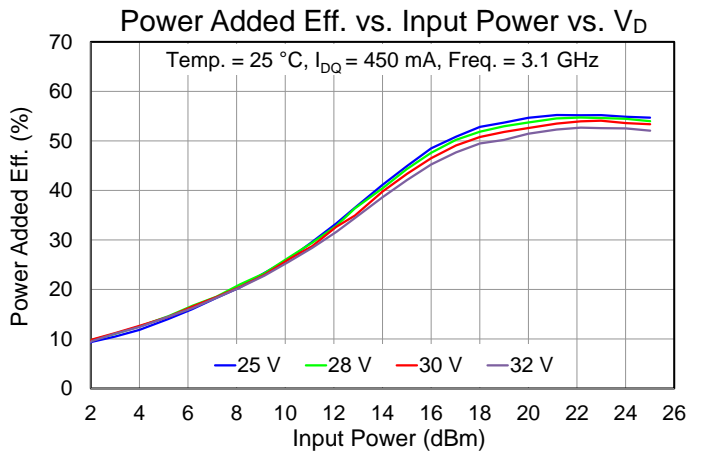
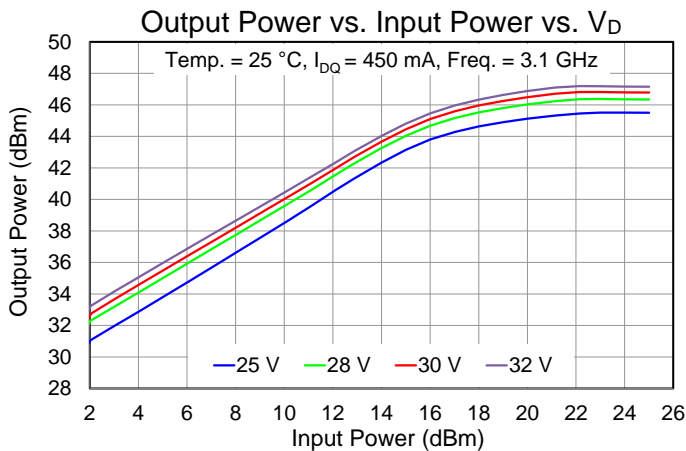
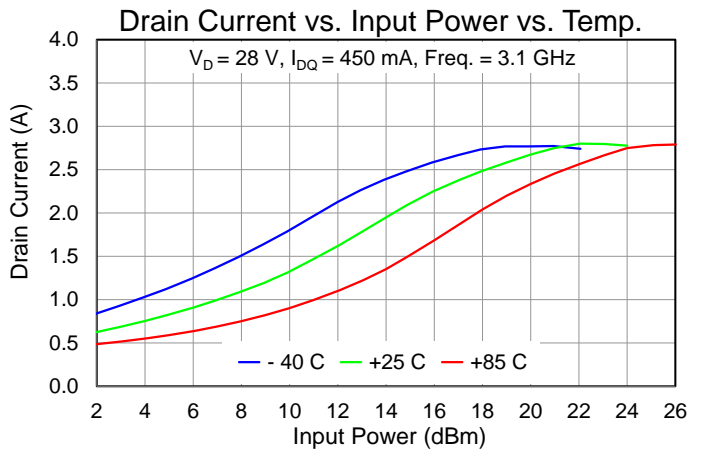
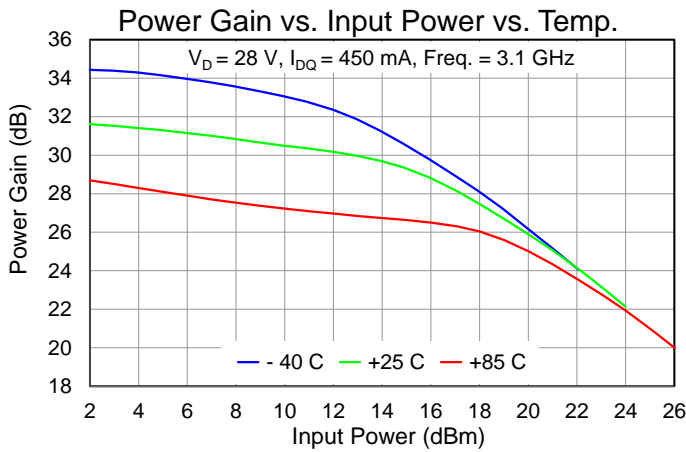
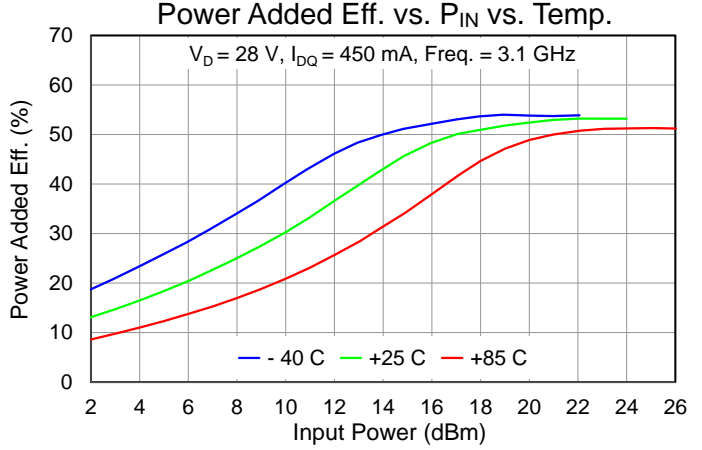
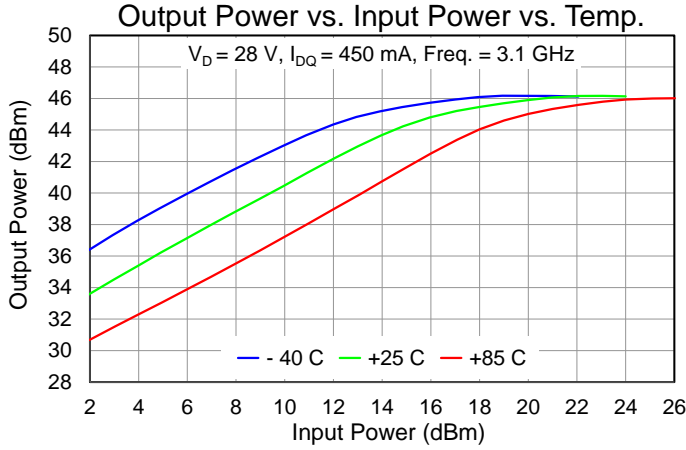

### Performance Plots – Large Signal (Pulsed)

Test conditions unless otherwise noted: Temp. = 25 °C,  $V_D = 28$  V,  $I_{DQ} = 450$  mA, PW = 100 us, Duty Cycle = 10%

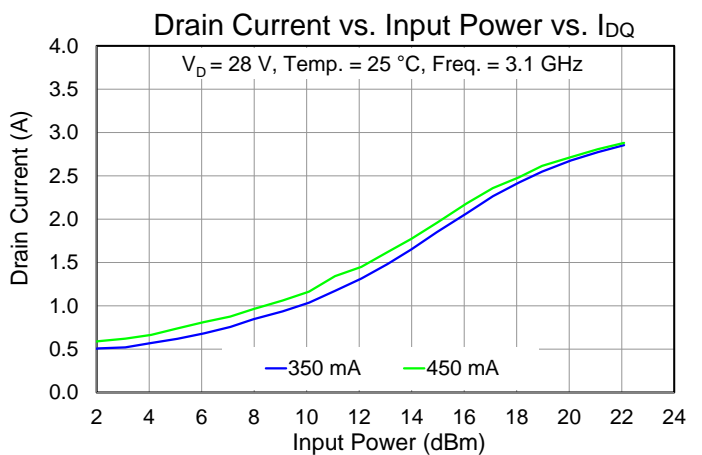
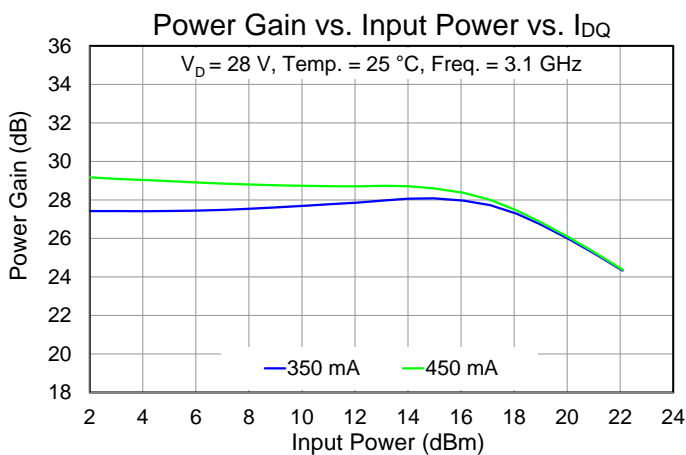
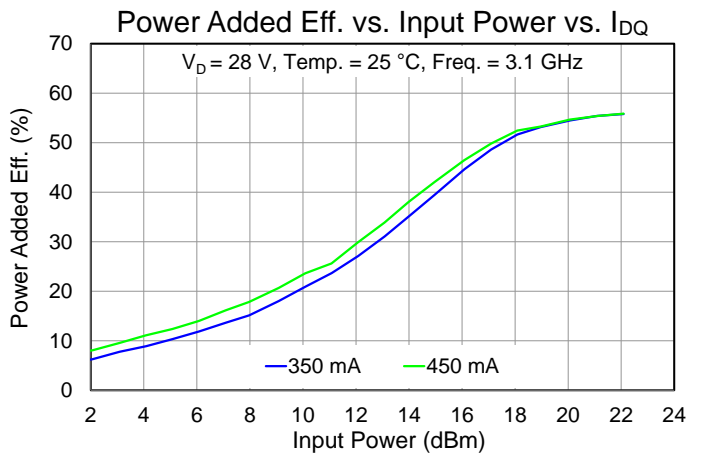
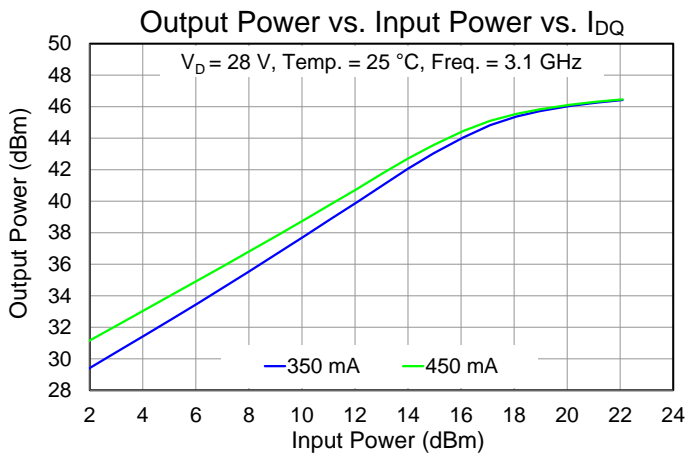
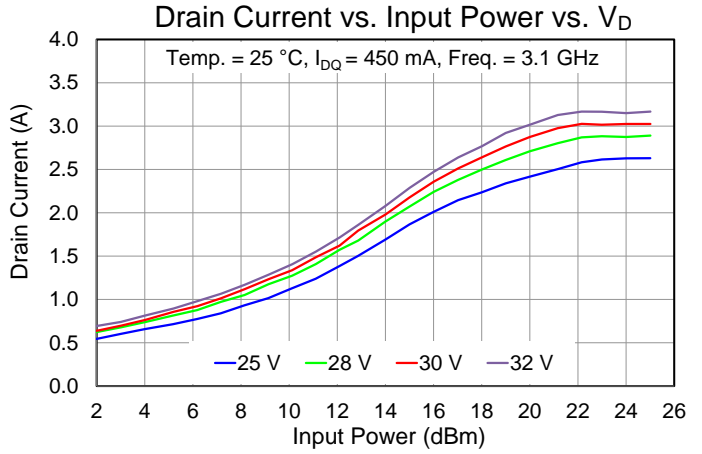
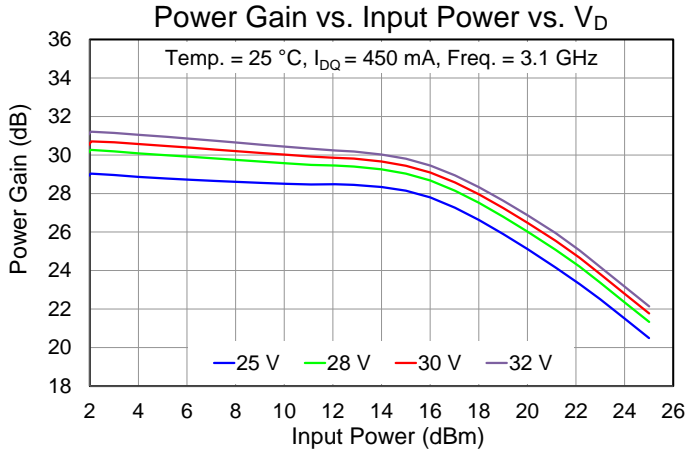

### Performance Plots – Large Signal (Long Pulse Comparison)

Test conditions unless otherwise noted: Temp. = 25 °C,  $V_D = 28$  V,  $I_{DQ} = 450$  mA

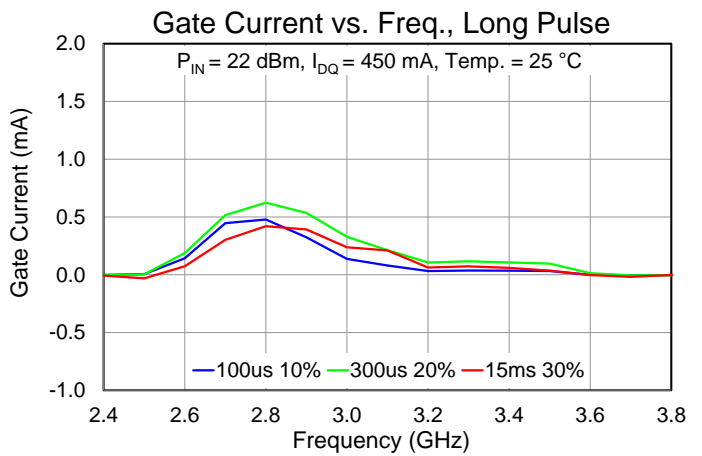
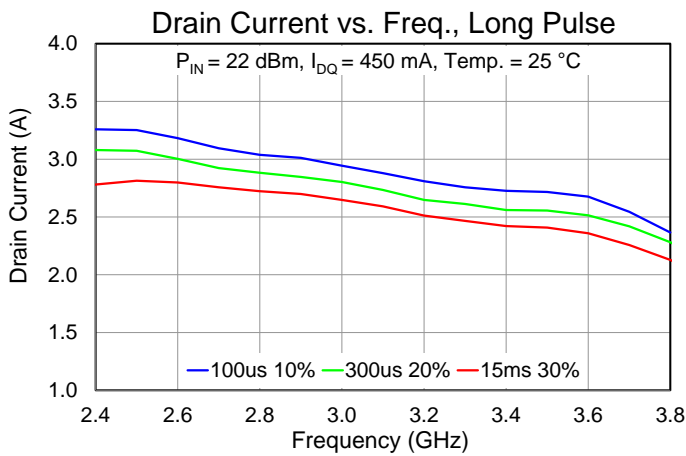
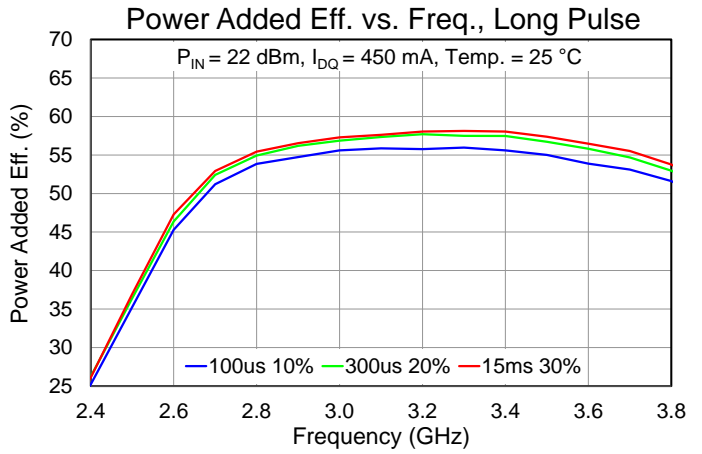
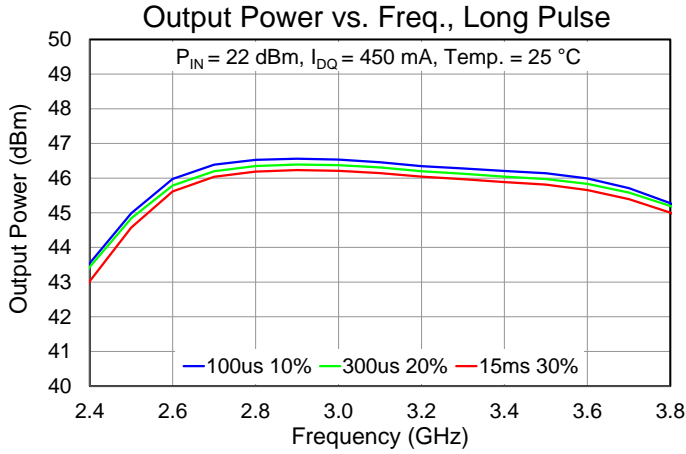

### Performance Plots – Harmonics

Test conditions unless otherwise noted: Temp. = 25 °C,  $V_D = 28$  V,  $I_{DQ} = 450$  mA, PW = 100 us, Duty Cycle = 10%

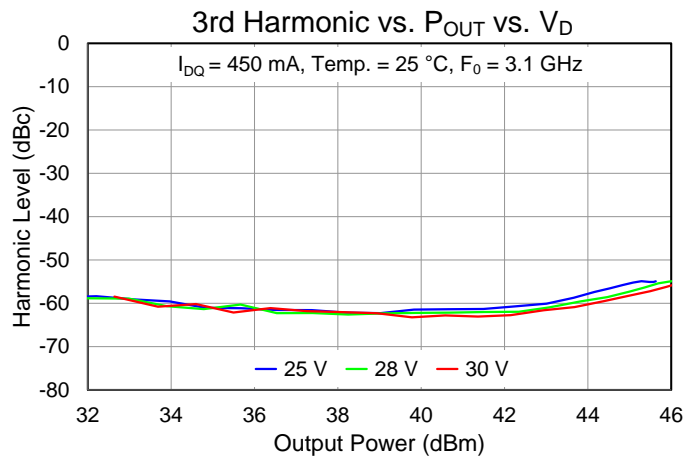
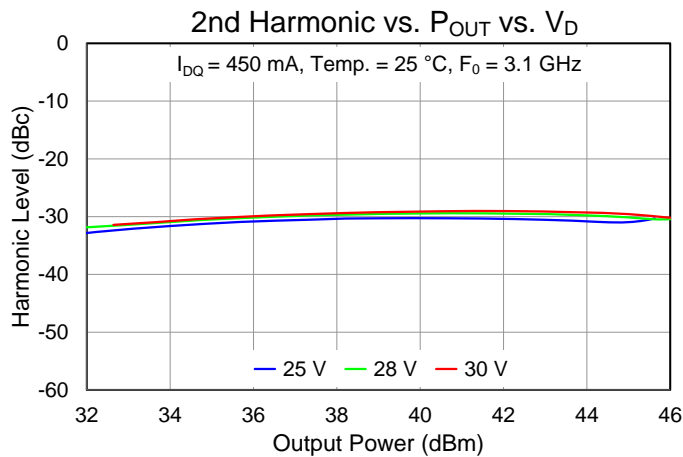
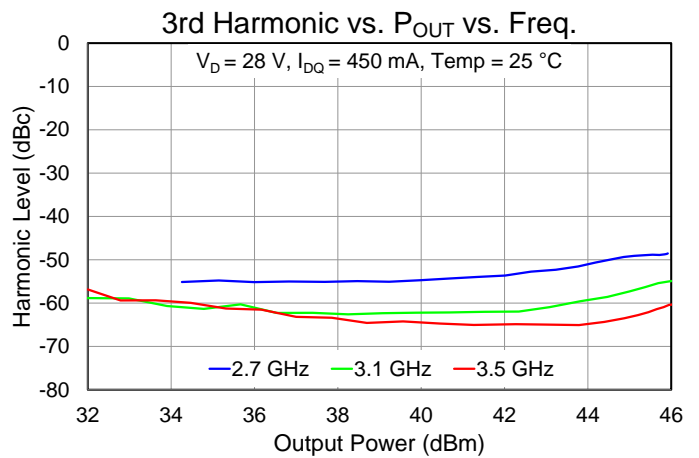
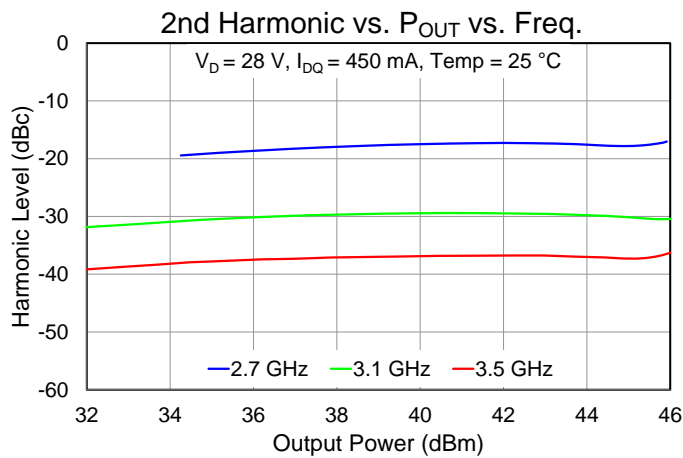
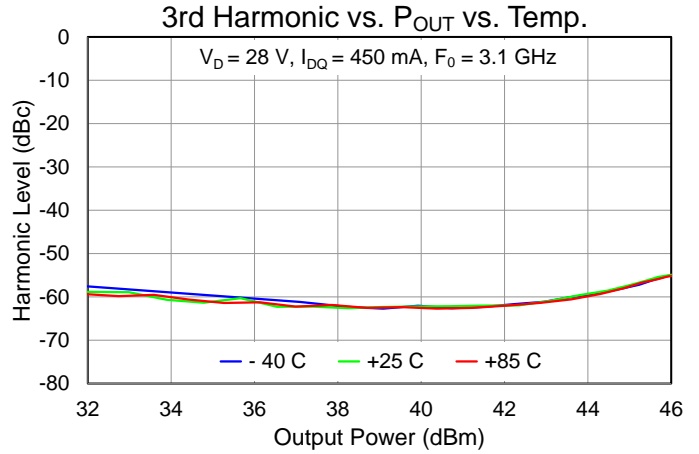
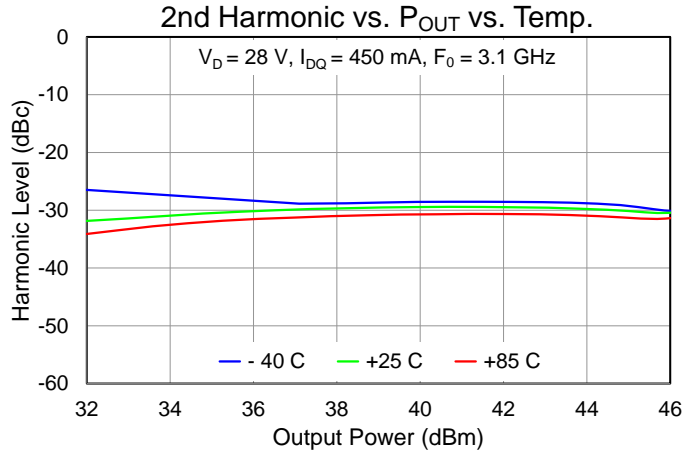



### Performance Plots – Small Signal

Test conditions unless otherwise noted: Temp. = 25 °C,  $V_D = 28$  V,  $I_{DQ} = 450$  mA

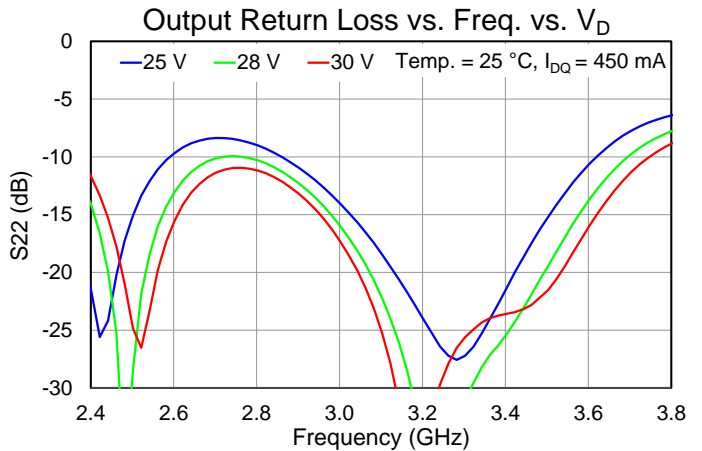
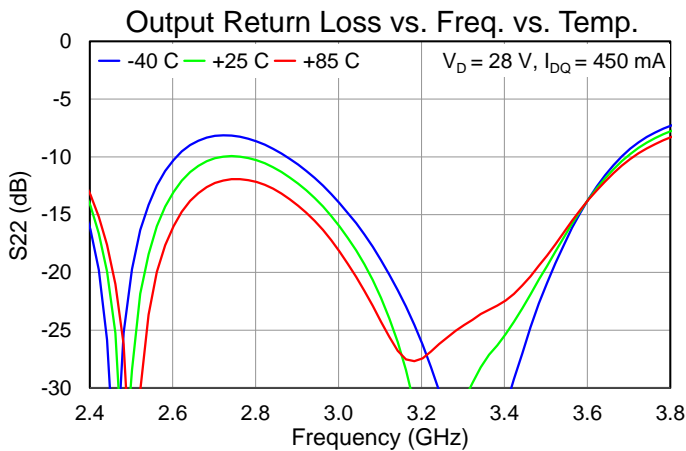
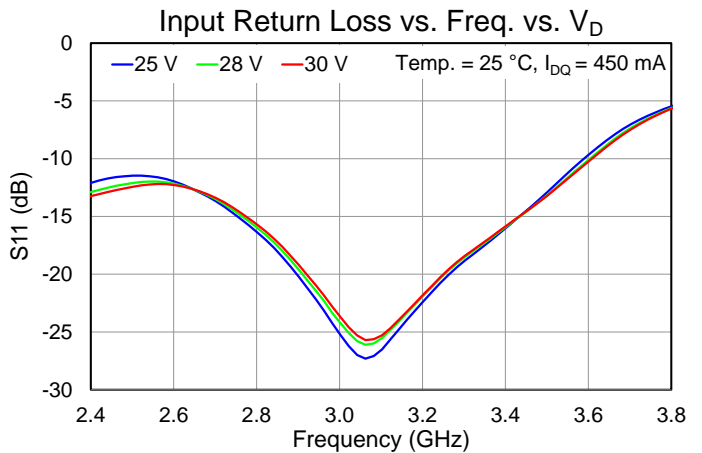
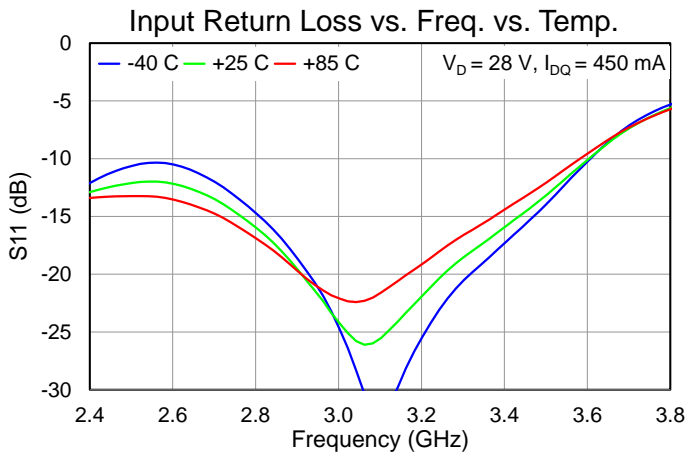
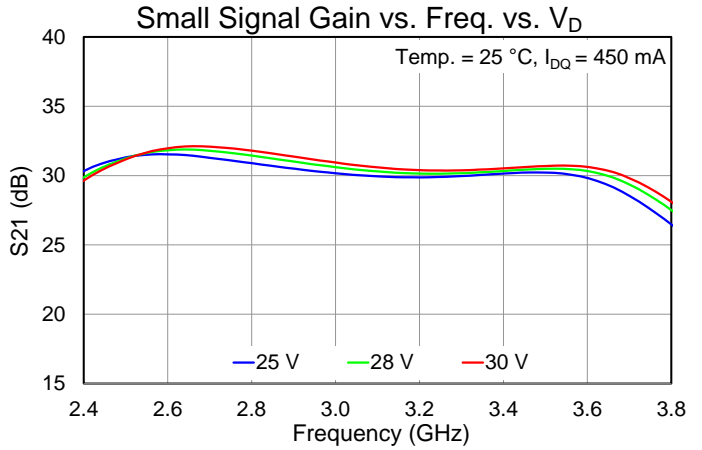
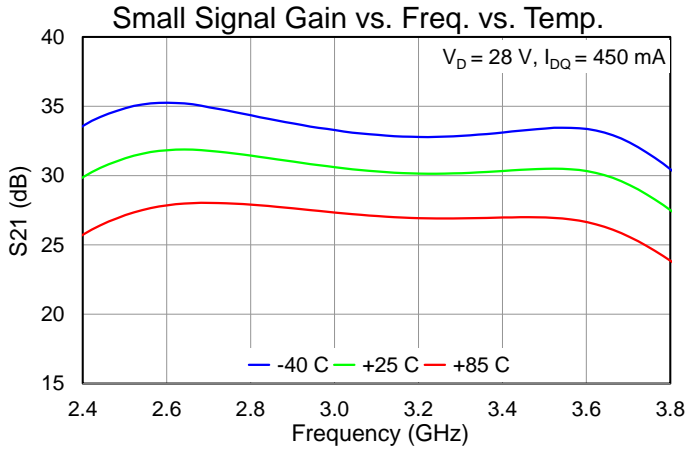

### Performance Plots – Small Signal

Test conditions unless otherwise noted: Temp. = 25 °C,  $V_D = 28$  V,  $I_{DQ} = 450$  mA

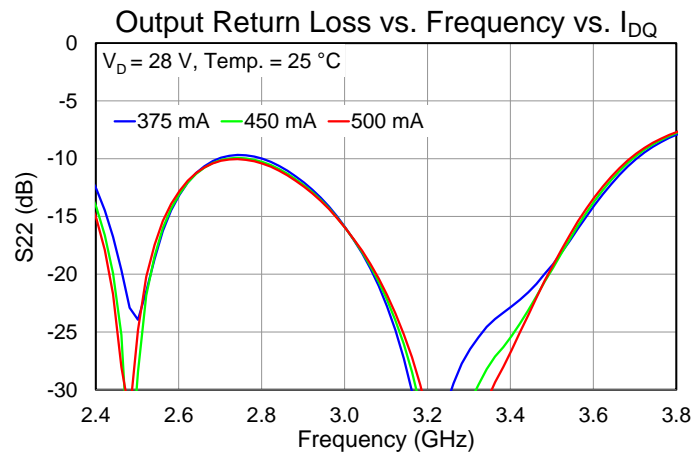
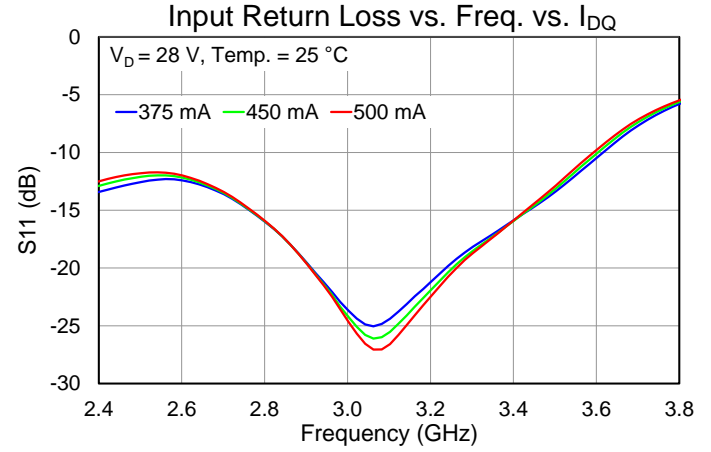
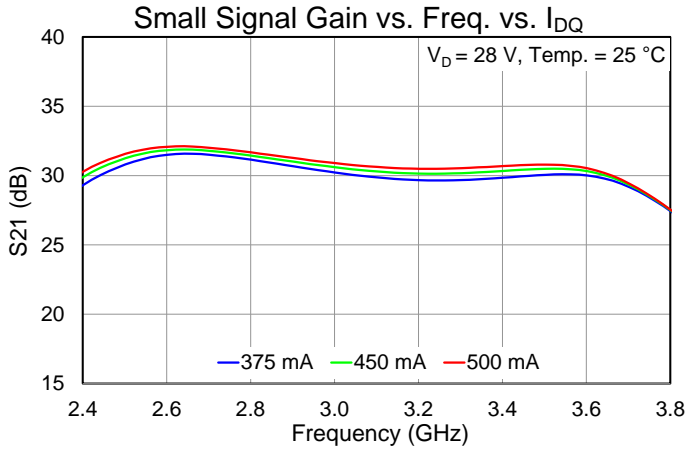

### Thermal and Reliability Information

Parameter	Test Conditions	Value	Units
Thermal Resistance ( $\theta_{JC}$ ) <sup>(1)</sup>	$T_{base} = 85^{\circ}C$	1.43	$^{\circ}C/W$
Channel Temperature ( $T_{CH}$ ) (Quiescent)	$V_D = 28 V, I_{DQ} = 450 mA$ $P_{DISS} = 12.6 W$	103	$^{\circ}C$
Thermal Resistance ( $\theta_{JC}$ ) <sup>(1)</sup>	$T_{base} = 85^{\circ}C, V_D = 28 V, I_{DQ} = 450 mA, Freq = 2.7 GHz,$	0.72	$^{\circ}C/W$
Channel Temperature ( $T_{CH}$ ) (Under RF drive)	$I_{D\_Drive} = 2.984 A, P_{IN} = 25 dBm, P_{OUT} = 46.1 dBm,$ $P_{DISS} = 40.5 W, PW = 100 us, DC = 10\%$	114	$^{\circ}C$

Notes:

1. Thermal resistance measured to back of package.
2. Refer to the following document: [GaN Device Channel Temperature, Thermal Resistance, and Reliability Estimates](#)

### Power Dissipation

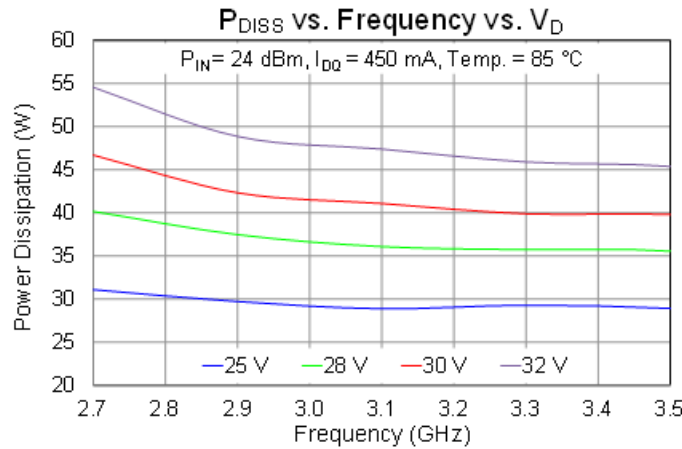

**Applications Circuit**

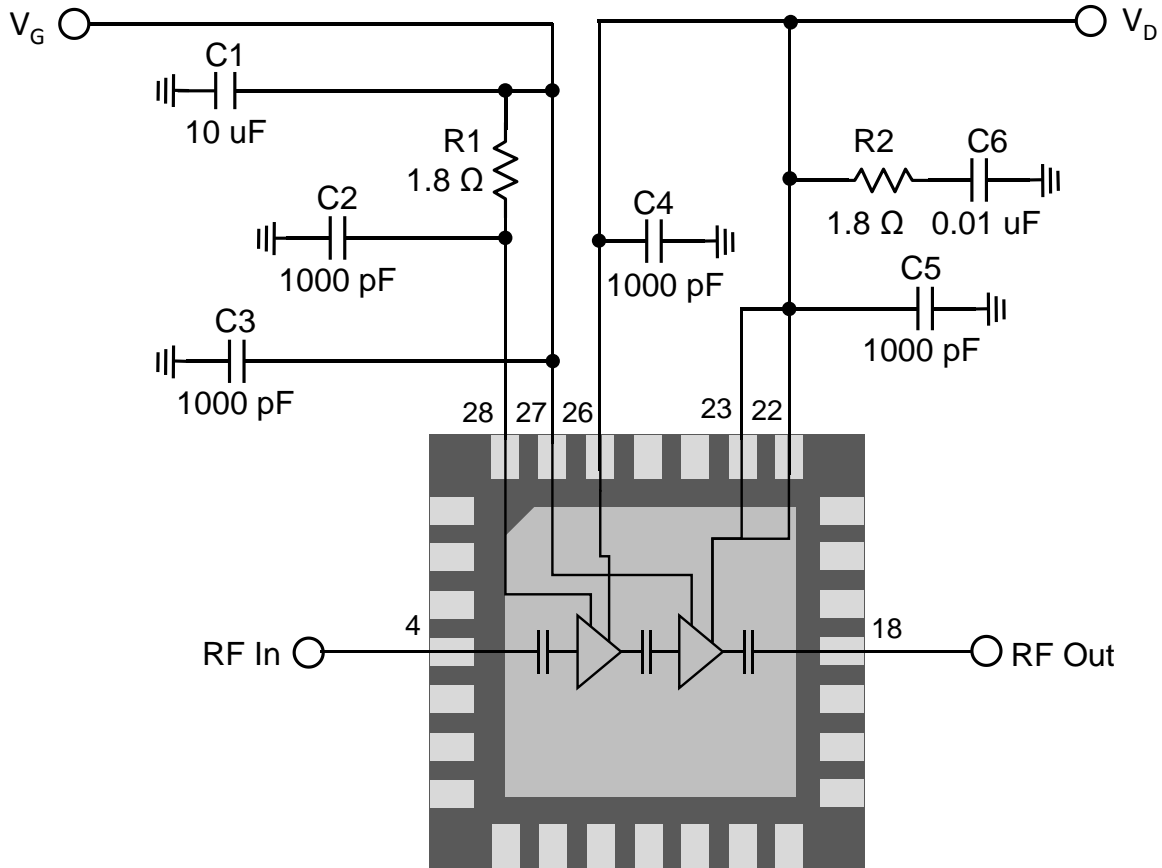

**Bias Up Procedure**

1. Set  $I_D$  limit to 4500mA,  $I_G$  limit to 40mA
2. Set  $V_G$  to -6.0 V
3. Set  $V_D$  +28 V
4. Adjust  $V_G$  more positive until  $I_{DQ} = 450mA$  ( $V_G \sim -2.7$  V Typical)
5. Apply RF signal

**Bias Down Procedure**

1. Turn off RF supply
2. Reduce  $V_G$  to -6.0V. Ensure  $I_{DQ} \sim 0mA$
3. Set  $V_D$  to 0V
4. Turn off  $V_D$  supply
5. Turn off  $V_G$  supply

### Evaluation Board and Mounting Detail

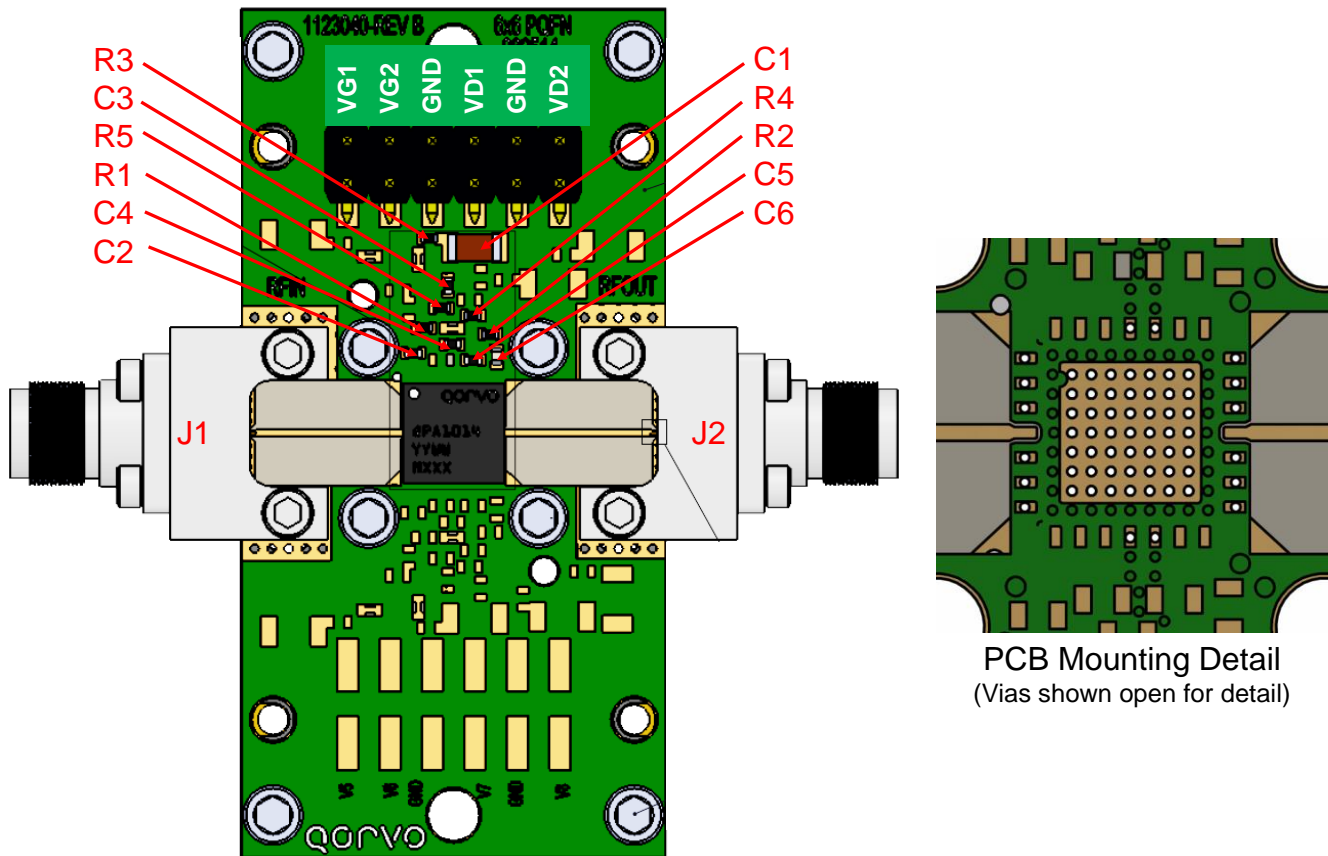

**Notes:**

1. RF Layer is 0.008" thick Rogers Corp. RO40003C ( $\epsilon_r = 3.55$ ). Metal layers are 0.5 oz. copper.
2. Via holes under the DUT should be copper-filled to improve thermal and electrical performance.

### Bill of Materials

Ref. Des.	Component	Value	Manuf.	Part Number
C1	Surface Mount Cap.	CAP, 1206, 10uF, 20%, 50V, 20%, X5R	Various	
C2 – C5	Surface Mount Cap.	CAP, 0402, 1000pF, 10%, 100V, X7R	Various	
C6	Surface Mount Cap.	CAP, 0402, 0.01uF, $\pm 10\%$ , 50V, X7R	Various	
R1, R2	Surface Mount Res.	RES, 1.8 OHM, $\pm 5\%$ , 1/10 W, 0402	Various	
R3 – R5 <sup>1</sup>	Surface Mount Res.	RES, 0 OHM, $\pm 5\%$ , 0402	Various	
J1, J2	RF Connector	2.92 mm End Launch	SW Microwave	1092–01A–5

**Note:**

1. Replace R3–R5 with a metal trace, as they are not needed for operation. Thus, they are not shown in the schematic.

### Mechanical Information

NOTES: UNLESS OTHERWISE SPECIFIED;

1. PART IS MOLD ENCAPSULATED.
2. PACKAGE EXPOSED METALLIZATION IS GOLD PLATED.

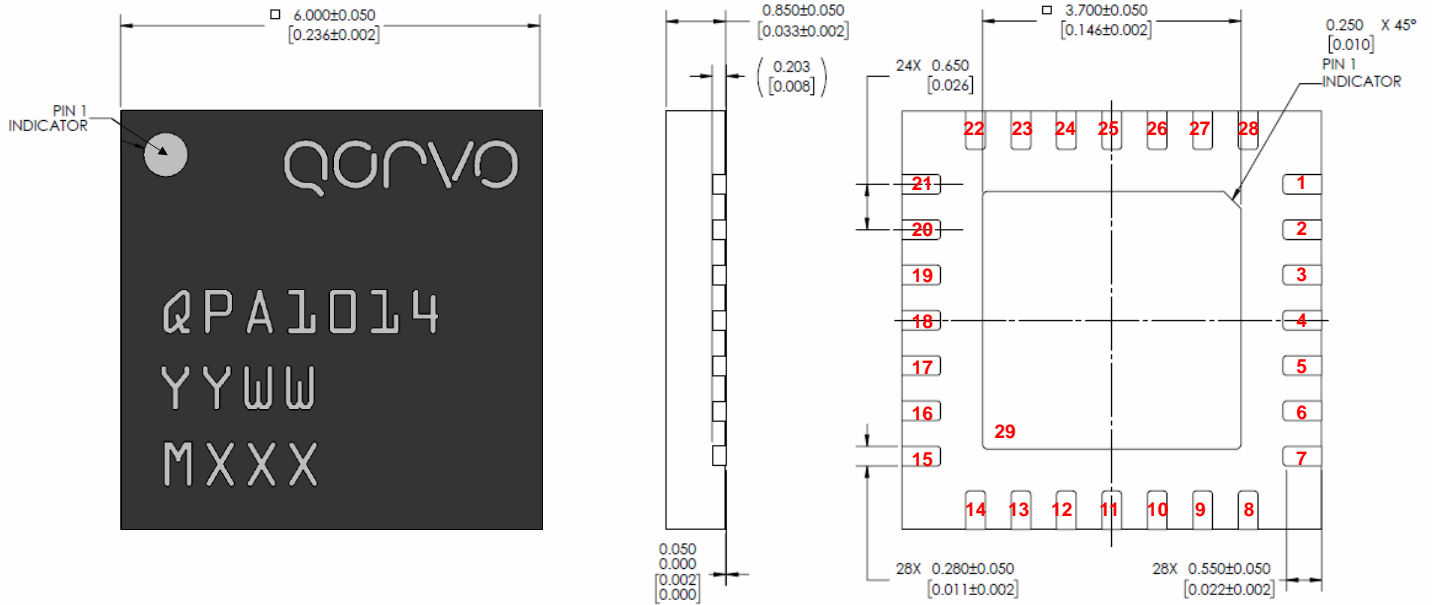

### Pin Description

Pin Number	Symbol	Description
1-3, 5-17, 19-21, 24-25	NC	No internal connection. Recommend grounding at the PCB level.
4	RF Input	50 Ohm RF input. Pad is DC blocked.
18	RF Output	50 Ohm RF output. Pad is DC blocked.
22, 23	$V_{D2}$	2 <sup>nd</sup> Stage Drain Voltage; bias network is required ( $V_{D1}$ and $V_{D2}$ can be tied together in application)
26	$V_{D1}$	1 <sup>st</sup> Stage Drain Voltage; bias network is required ( $V_{D1}$ and $V_{D2}$ can be tied together in application)
27	$V_{G2}$	2 <sup>nd</sup> Stage Gate Voltage; bias network is required ( $V_{G1}$ and $V_{G2}$ can be tied together in application)
28	$V_{G1}$	1 <sup>st</sup> Stage Gate Voltage; bias network is required ( $V_{G1}$ and $V_{G2}$ can be tied together in application)
29	GND	Ground connection (center pad).

### Absolute Maximum Ratings

Parameter	Value / Range
Drain Voltage ( $V_D$ )	40 V
Drain Current ( $I_{D1}/I_{D2}$ )	0.39 / 3.5 A
Gate Voltage Range	-8 to 0 V
Gate Current ( $I_G$ )	See $I_{G\_Max}$ plot
Dissipated Power ( $P_{DISS}$ ) <sup>1</sup>	44.25 W
Input Power (50 $\Omega$ , 85 °C) <sup>2</sup>	28 dBm
Input Power (3:1 VSWR, 85 °C) <sup>2</sup>	28 dBm
Mounting Temperature (30 seconds)	260 °C
Storage Temperature	-55 to 150 °C

Note:

<sup>1</sup>  $T_{BASE} = 85\text{ °C}$ ,  $T_{CH} = 225\text{ °C}$

<sup>2</sup>  $V_D = 28\text{ V}$ ,  $I_{DQ} = 450\text{ mA}$

Operation of this device outside the parameter ranges given above may cause permanent damage. These are stress ratings only, and functional operation of the device at these conditions is not implied.

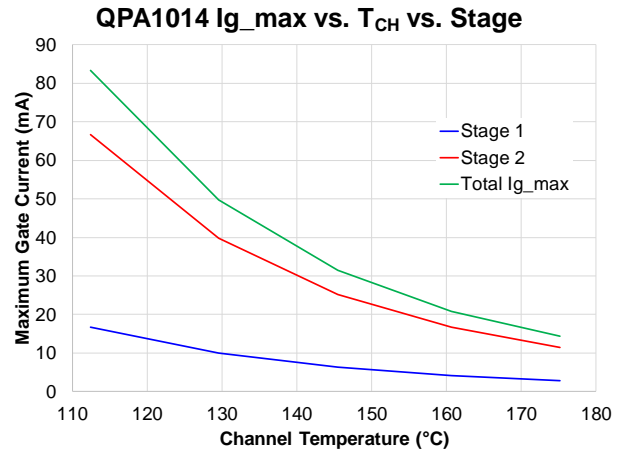

### Recommended Soldering Temperature Profile

