



# QPA1022D

## 8.5–11 GHz 4 W GaN Power Amplifier

### Product Overview

Qorvo's QPA1022D is a MMIC power amplifier fabricated on Qorvo's production 0.15  $\mu\text{m}$  GaN on SiC process (QGaN15). Covering 8.5–11.0 GHz, the QPA1022D provides > 4 W of saturated output power and 24 dB of large-signal gain while achieving 45% power-added efficiency.

The QPA1022D is matched to 50 $\Omega$  with integrated DC blocking capacitors at RF output and DC grounded input port. It also has a built-in power detector for system RF power checking. With a compact dimension of 2.65 x 1.25 x 0.10 mm, it can support tight lattice spacing requirements for phased array radar applications. It is also an ideal component to support test instrumentation and commercial communication systems.



### Key Features

- Frequency Range: 8.5–11 GHz
- $P_{\text{SAT}}$  ( $P_{\text{IN}}=12$  dBm): 36 dBm
- PAE ( $P_{\text{IN}}=12$  dBm): 45 %
- Power Gain ( $P_{\text{IN}}=12$  dBm): 24 dB
- Small Signal Gain: 31 dB
- Bias:  $V_{\text{D}} = 22$  V,  $I_{\text{DQ}} = 180$  mA
- Die Dimensions: 2.63 x 1.23 x 0.10 mm

*Performance is typical across frequency. Please reference electrical specification table and data plots for more details.*

### Applications

- Radar
- Electronic Warfare
- Communications

### Functional Block Diagram

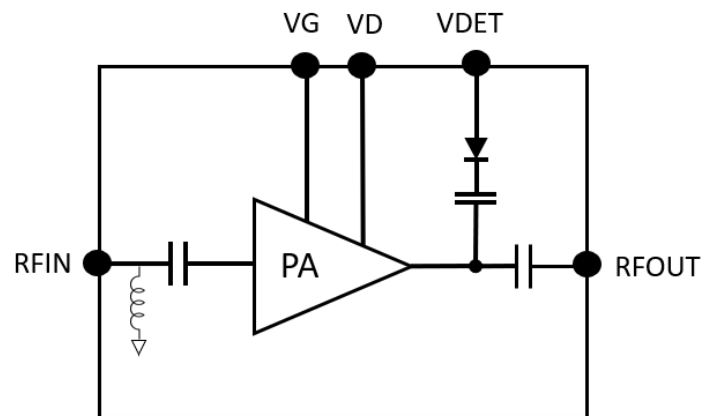

### Ordering Information

Part No.	Description
QPA1022D	8.5 to 11 GHz 4 W GaN Power Amplifier
QPA1022DS2	Device Sample (2 pcs)
QPA1022DEVB	Evaluation Board for QPA1022D

### Absolute Maximum Ratings

Parameter	Value / Range	Units
Drain Voltage ( $V_D$ )	28	V
Gate Voltage Range ( $V_G$ )	-5 to 0	V
Drain Current ( $I_D$ )	600	mA
Gate Current ( $I_G$ )	10	mA
Input Power ( $P_{IN}$ ), 3:1 VSWR, $V_D=22$ V, $I_{DQ}=180$ mA, 85 °C	27	dBm
Storage Temperature	-55 to +150	°C

Exceeding any one or a combination of the Absolute Maximum Rating conditions may cause permanent damage to the device. Extended application of Absolute Maximum Rating conditions to the device may reduce device reliability.

### Recommended Operating Conditions

Parameter	Value / Range	Units
Drain Voltage ( $V_D$ )	22	V
Drain Current ( $I_{DQ}$ )	180	mA
Operating Temperature	- 40 to + 85	°C

Electrical specifications are measured at specified test conditions. Specifications are not guaranteed over all recommended operating conditions.

### Electrical Specifications

Test conditions unless otherwise noted: Temp = 25 °C,  $V_D = 22$  V,  $I_{DQ} = 180$  mA. Data de-embedded to the reference planes.

Parameter	Min	Typ	Max	Units
Operational Frequency	8.5		11	GHz
Output Power (Pulse and CW, $P_{IN}=12$ dBm)		36.5		dBm
Power Added Efficiency (Pulse and CW, $P_{IN}= 12$ dBm)		45		%
Large Signal Gain (Pulse and CW, $P_{IN}=12$ dBm)		24.5		dB
Small Signal Gain		31		dB
Input Return Loss		17		dB
Output Return Loss		7		dB
Harmonic Suppression (CW @ $P_{OUT} = 36$ dBm, $2f_0$ )		27		dBc
$P_{OUT}$ Temp. Coeff. ( $P_{IN} = 12$ dBm)		-0.001		dB/°C
Small Signal Gain Temp. Coefficient		-0.087		dB/°C

Note: For pulse power, Pulse Width = 100  $\mu$ S, Duty Cycle = 10%

**Performance Plots – Small Signal**

Test conditions unless otherwise noted:  $V_D = 22\text{ V}$ ,  $I_{DQ} = 180\text{ mA}$ , Temperature = + 25 °C

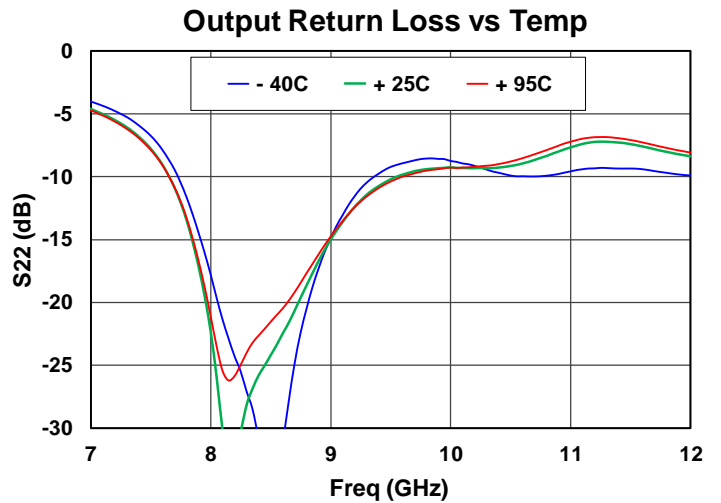
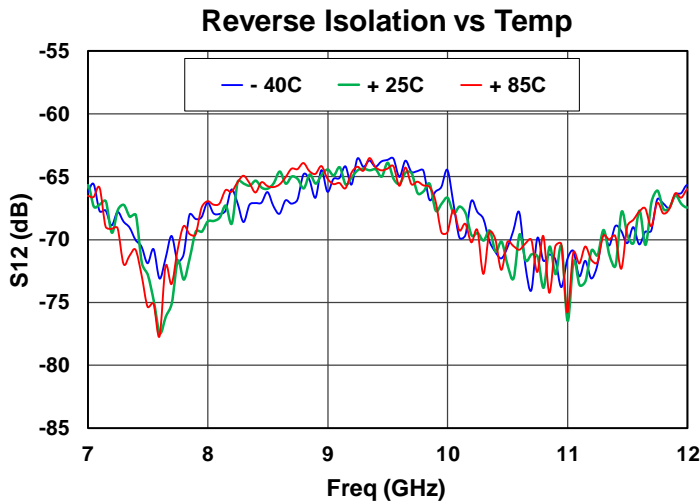
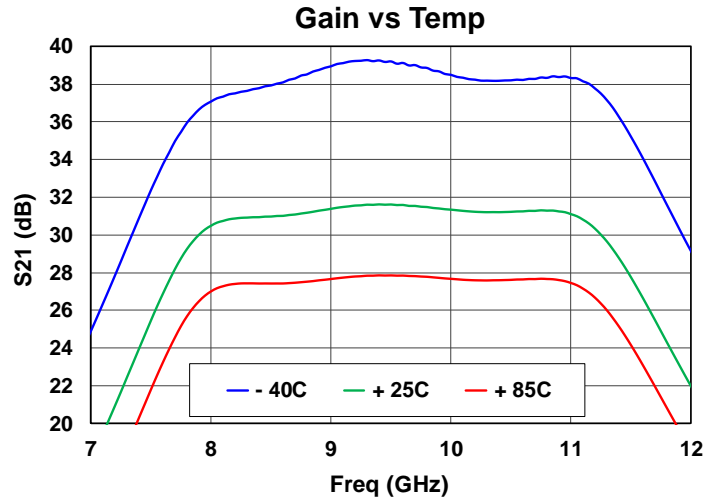
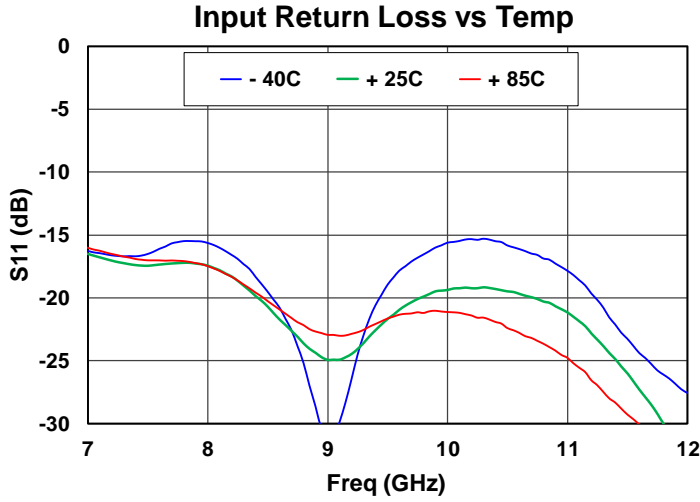

Performance Plots – Small Signal

Test conditions unless otherwise noted:  $V_D = 22\text{ V}$ ,  $I_{DQ} = 180\text{ mA}$ , Temperature = + 25 °C

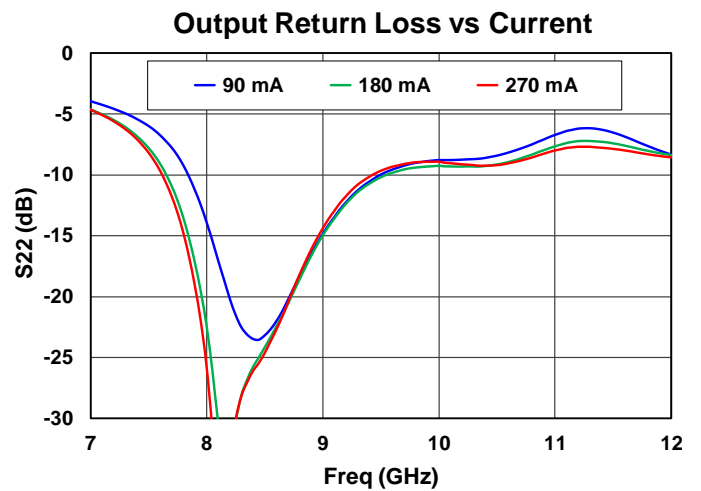
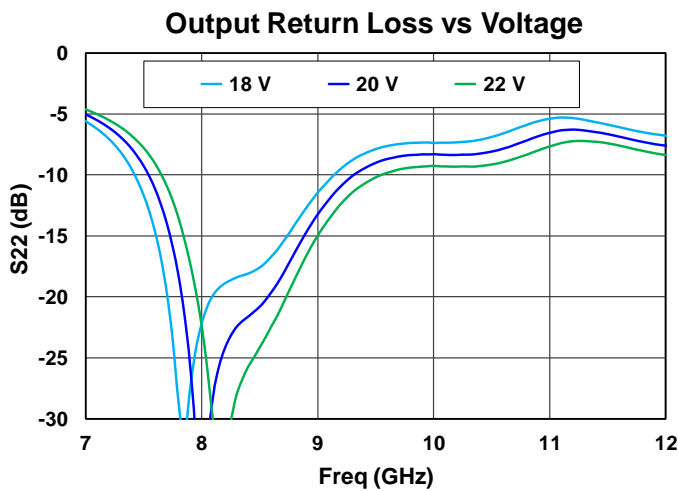
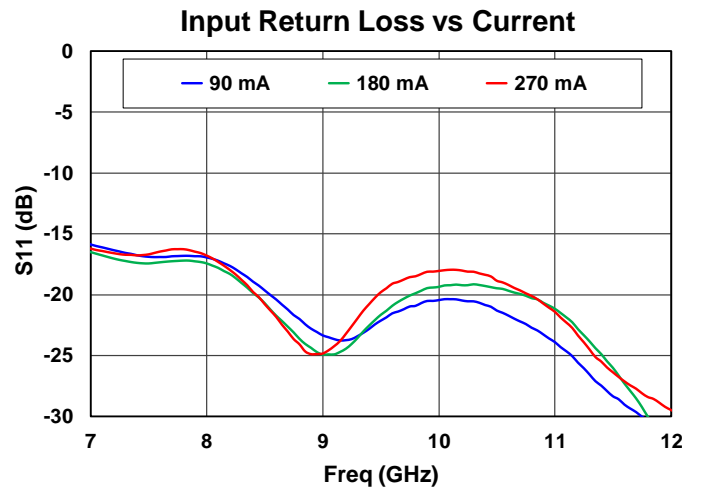
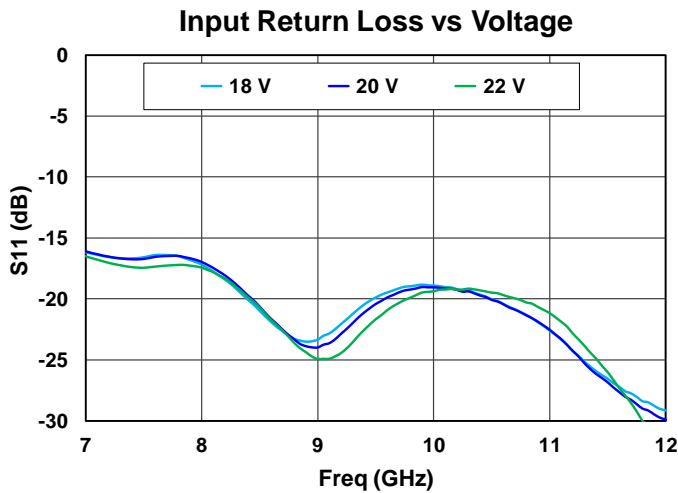
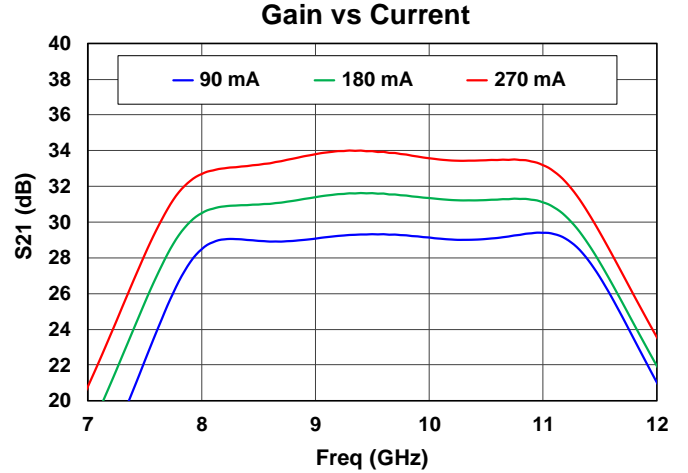
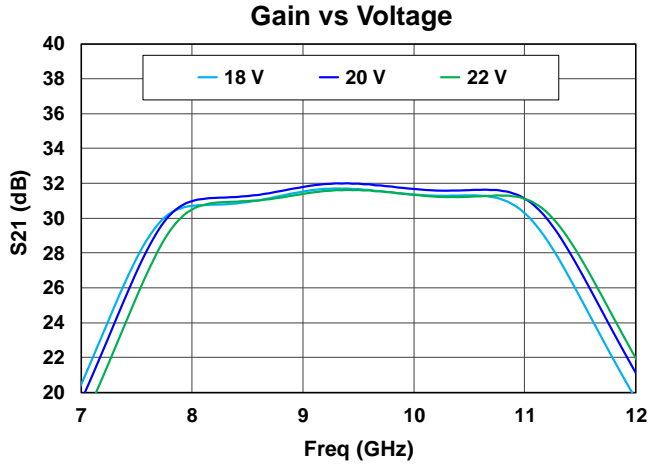

### Performance Plots – Large Signal, Pulse

Test conditions unless otherwise noted:  $V_D = 22\text{ V}$ ,  $I_{BQ} = 180\text{ mA}$ ,  $P_{in} = 12\text{ dBm}$ , Pulse Width = 100  $\mu\text{s}$ , DC = 10%, Temp = + 25 °C

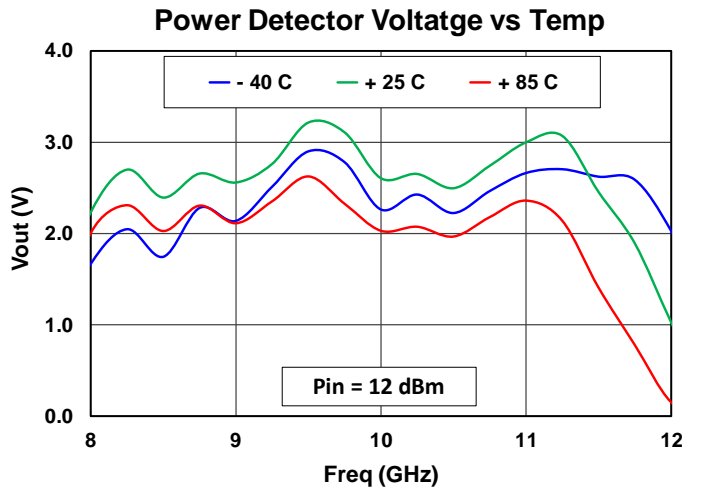
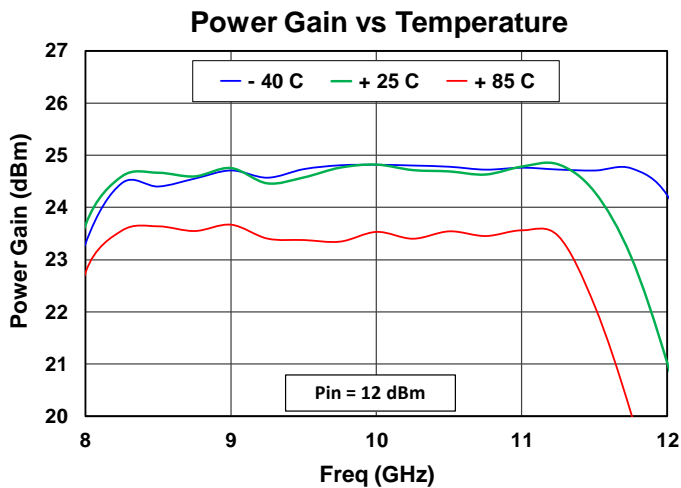
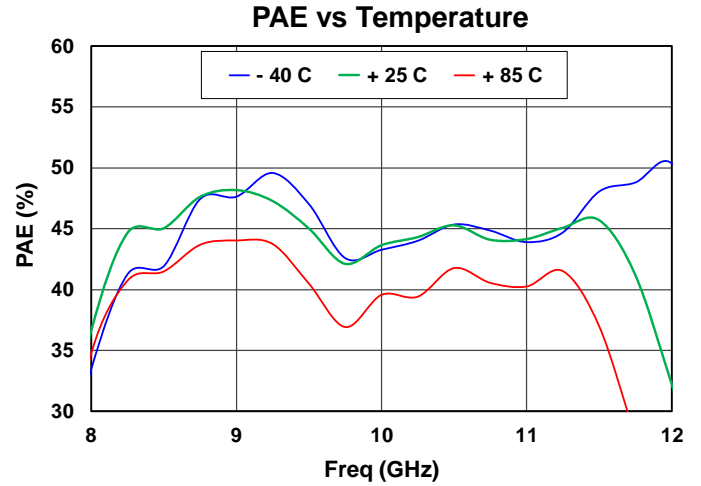
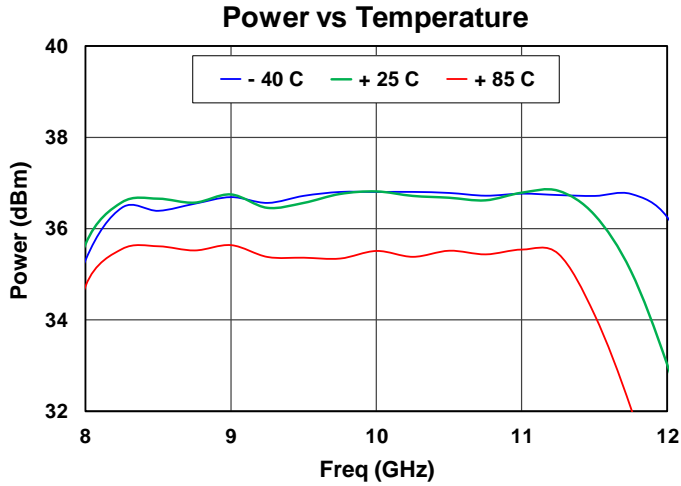

**Performance Plots – Large Signal, Pulse**

Test conditions unless otherwise noted:  $V_D = 22\text{ V}$ ,  $I_{DQ} = 180\text{ mA}$ ,  $P_{in} = 12\text{ dBm}$ , Pulse Width = 100  $\mu\text{s}$ , DC = 10%, Temp = + 25 °C

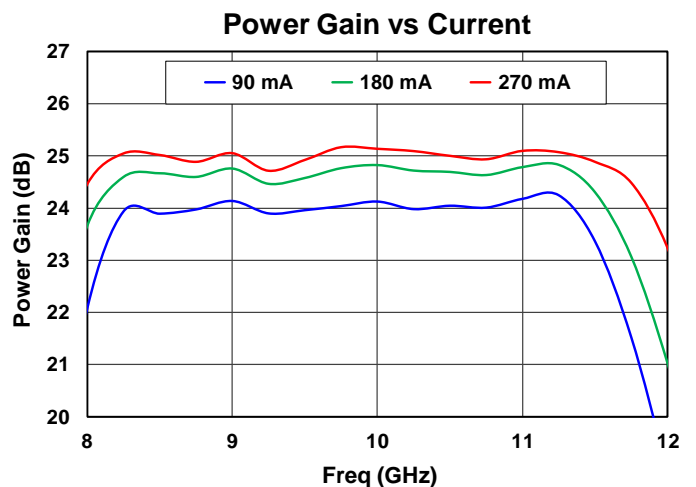
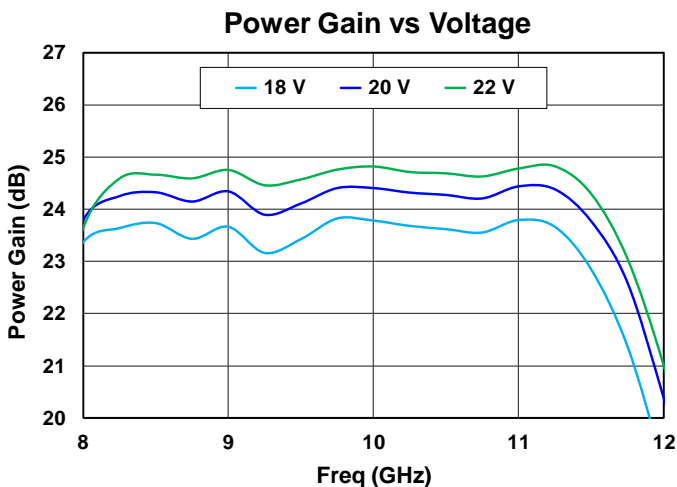
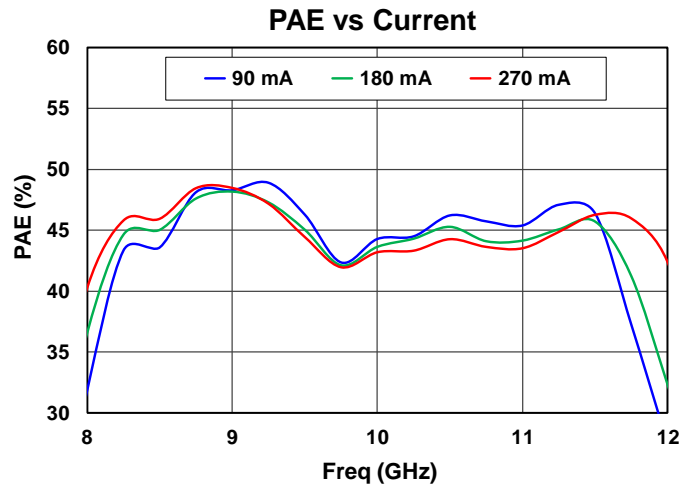
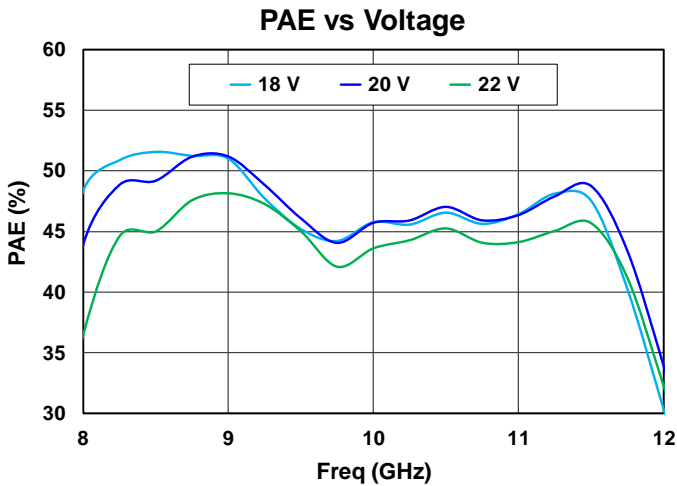
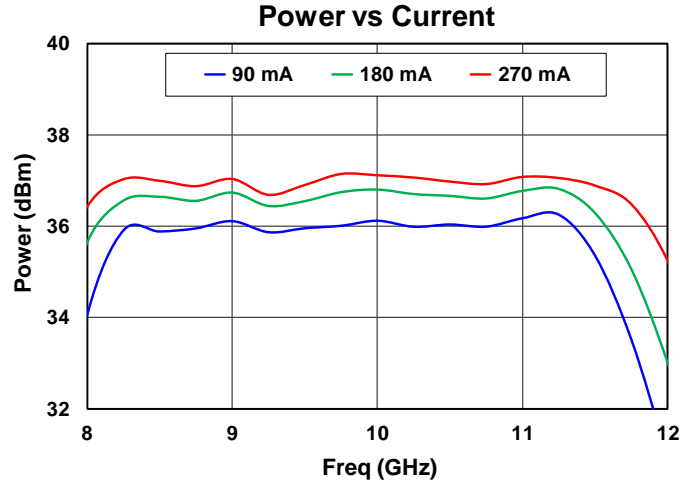
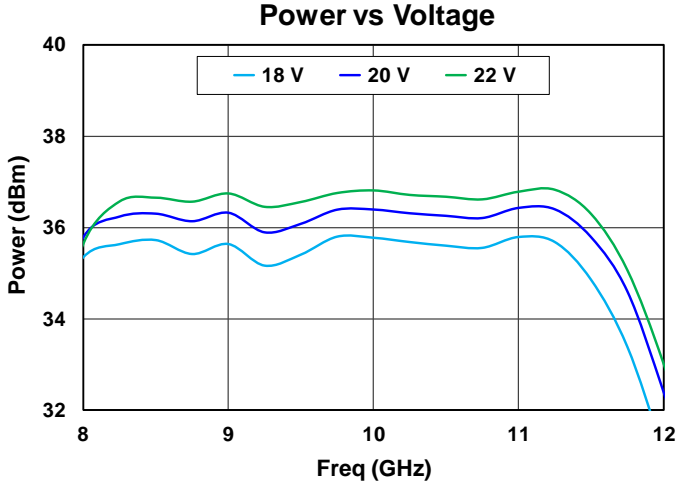

### Performance Plots – Large Signal, Pulse

Test conditions unless otherwise noted:  $V_D = 22\text{ V}$ ,  $I_{DQ} = 180\text{ mA}$ ,  $P_{in} = 12\text{ dBm}$ , Pulse Width = 100  $\mu\text{s}$ , DC = 10%, Temp = + 25 °C

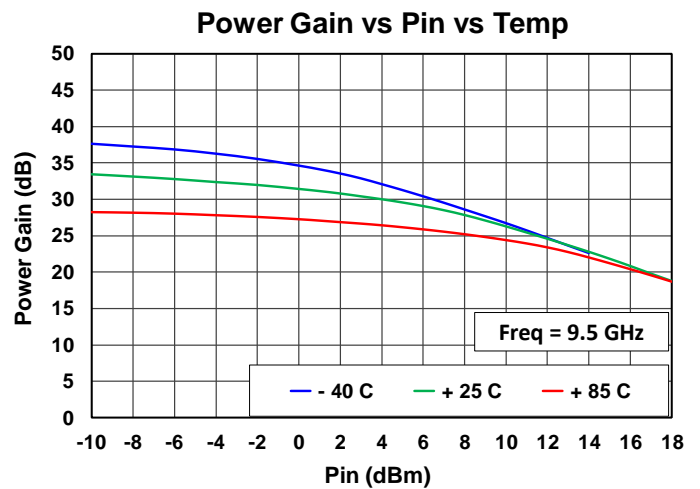
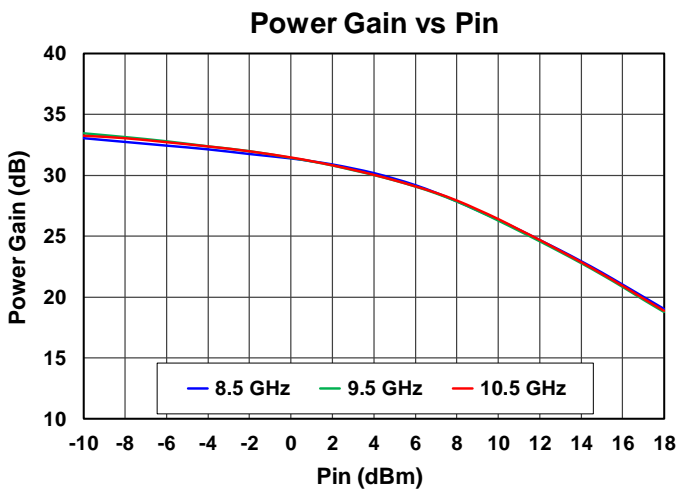
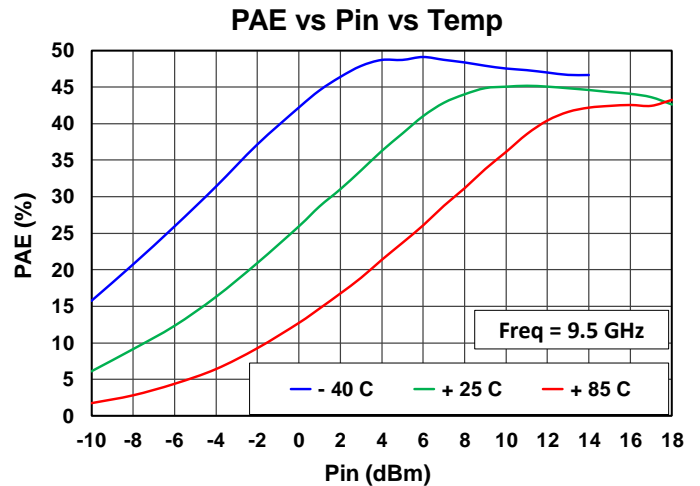
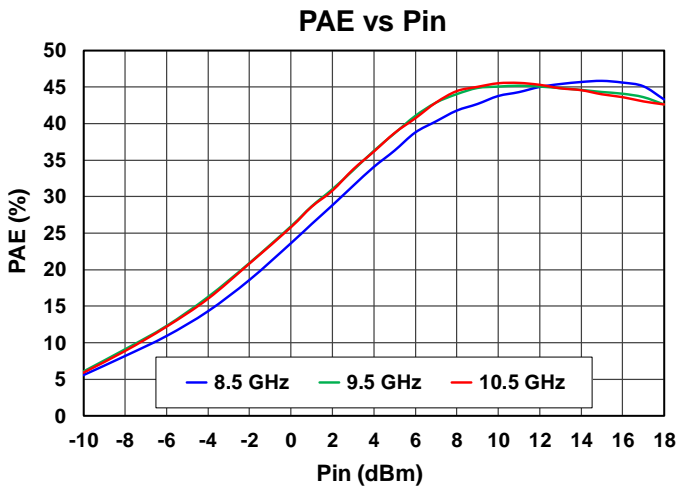
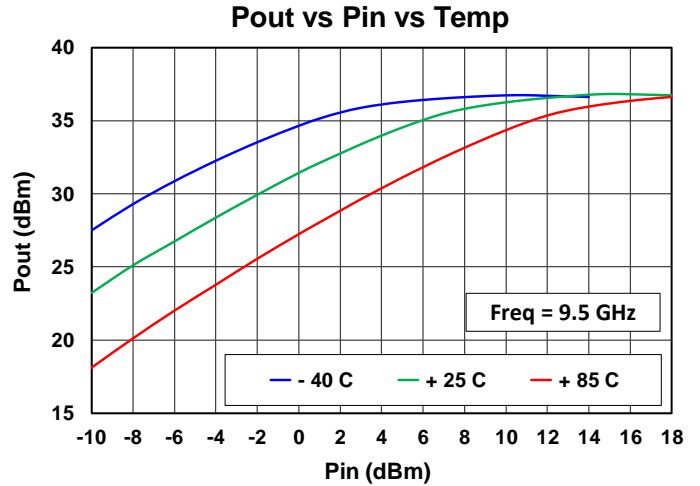
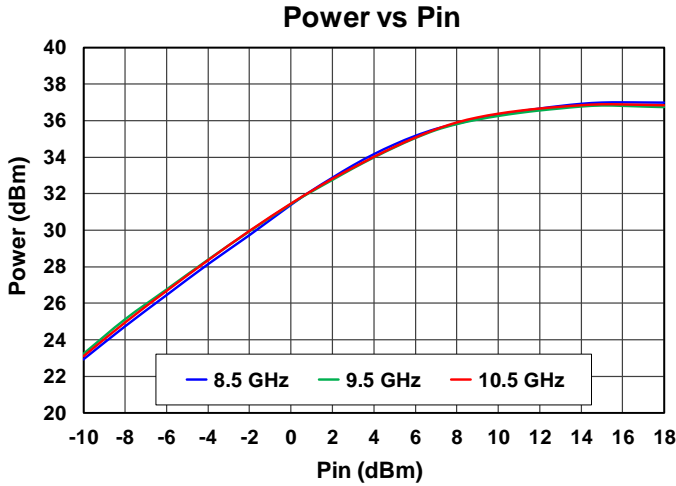

**Performance Plots – Large Signal, Pulse**

Test conditions unless otherwise noted:  $V_D = 22\text{ V}$ ,  $I_{DQ} = 180\text{ mA}$ ,  $P_{in} = 12\text{ dBm}$ , Pulse Width = 100  $\mu\text{s}$ , DC = 10%, Temp = + 25 °C

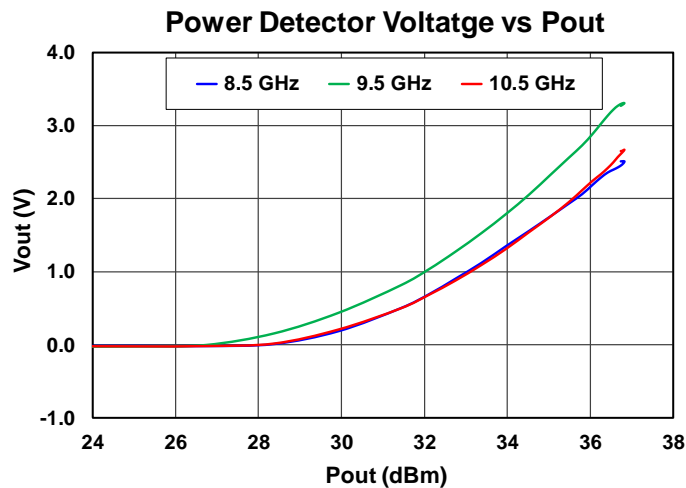
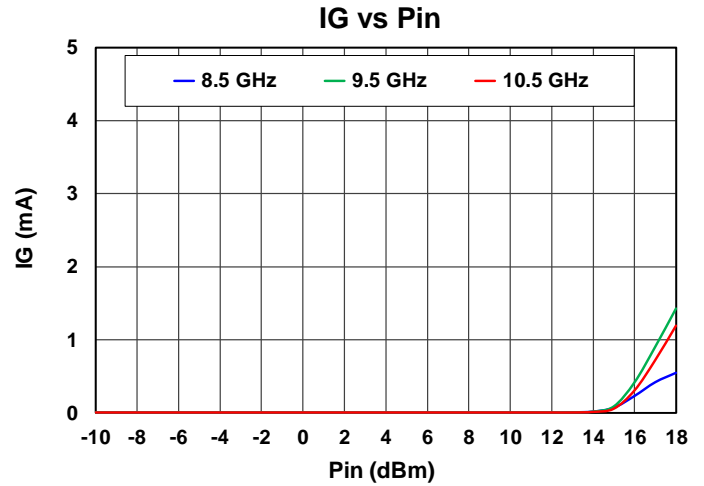
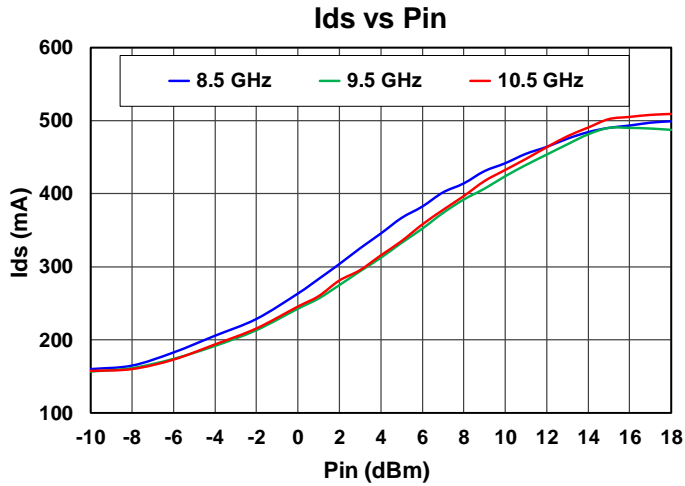



Performance Plots – Large Signal, CW

Test conditions unless otherwise noted:  $V_D = 22\text{ V}$ ,  $I_{DQ} = 180\text{ mA}$ ,  $P_{in} = 12\text{ dBm}$ , Temperature = + 25 °C

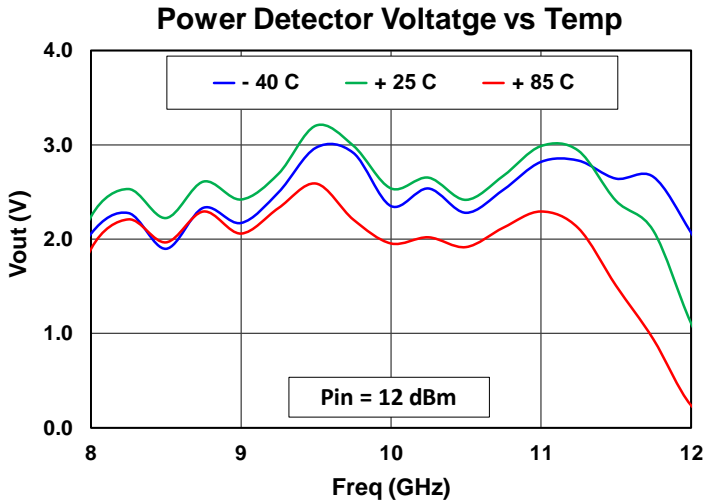
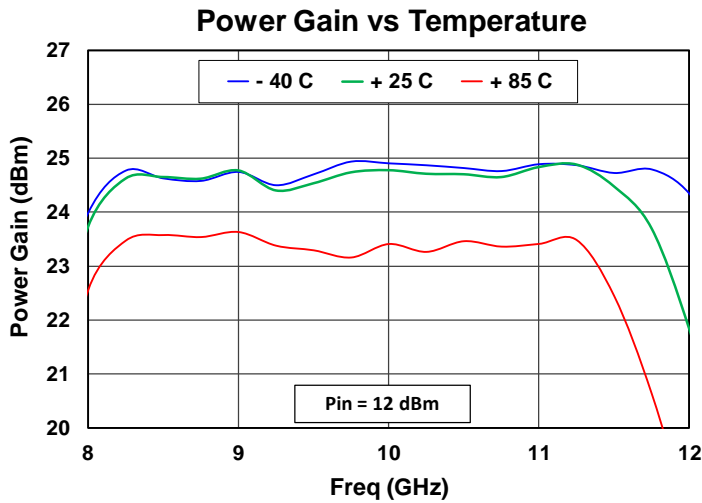
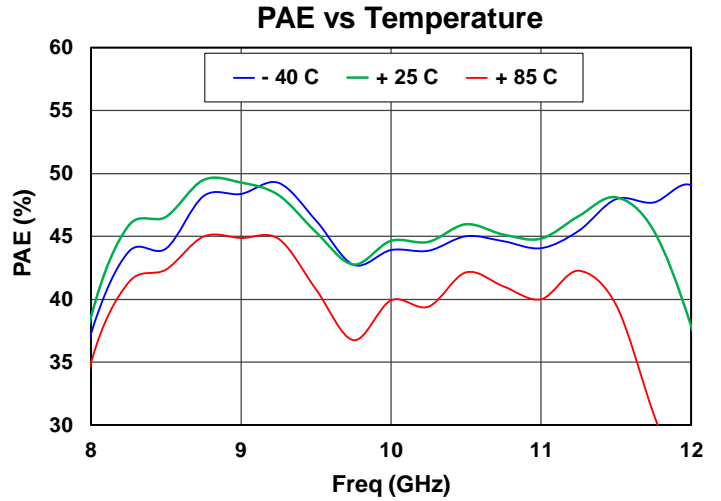
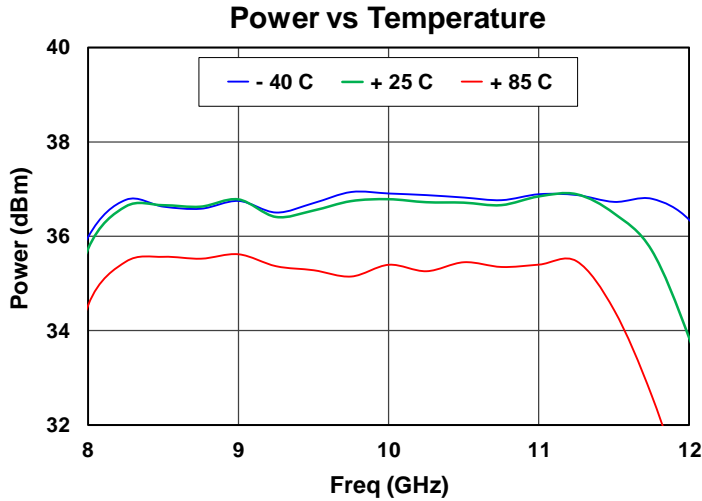

### Performance Plots – Large Signal, CW

Test conditions otherwise noted:  $V_D = 22\text{ V}$ ,  $I_{DQ} = 180\text{ mA}$ ,  $P_{in} = 12\text{ dBm}$ , Temperature = + 25 °C

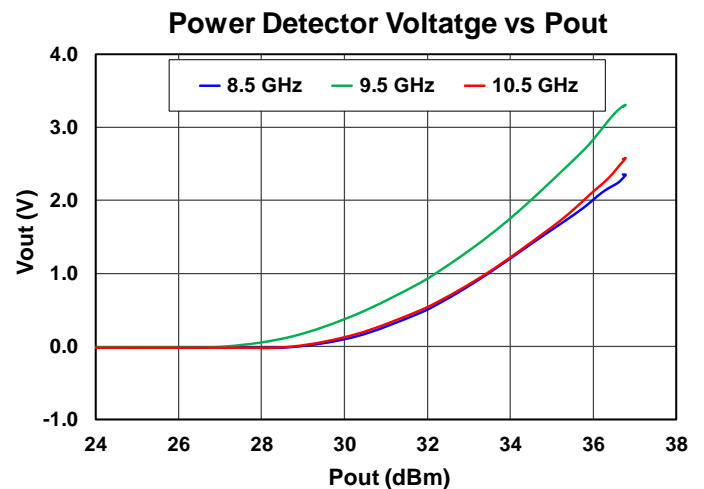
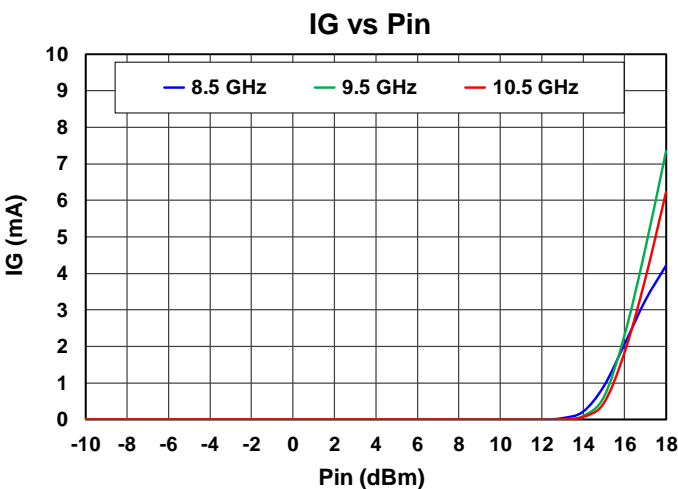
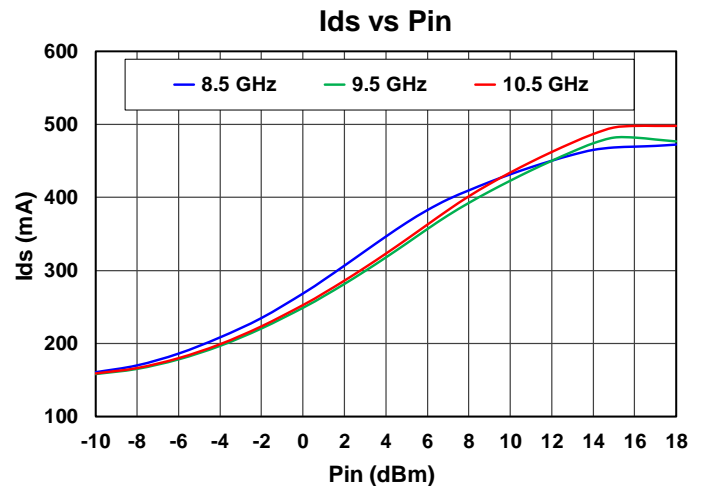
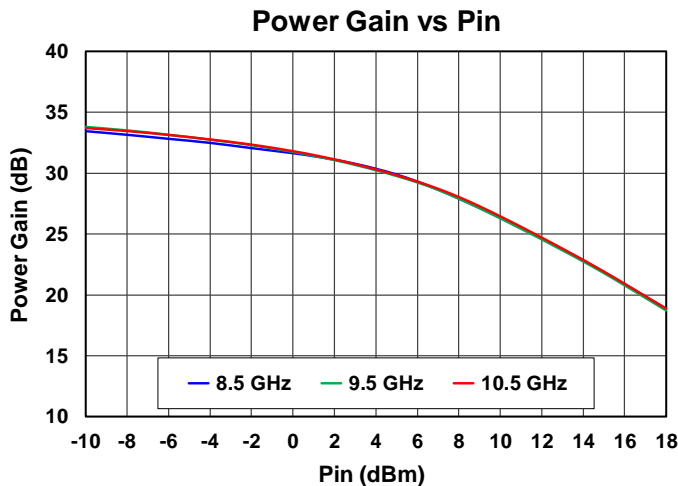
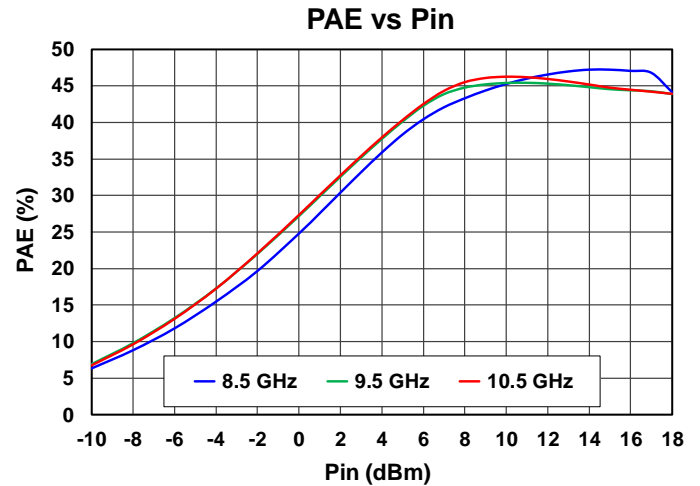
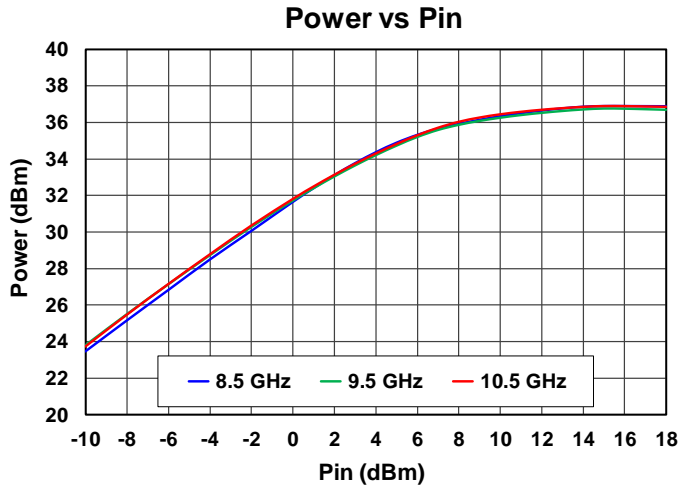

**Performance Plots – HarmonicSuppressions, CW**

Test conditions otherwise noted:  $V_D = 22\text{ V}$ ,  $I_{DQ} = 180\text{ mA}$ ,  $P_{in} = 12\text{ dBm}$ , Temperature = + 25 °C

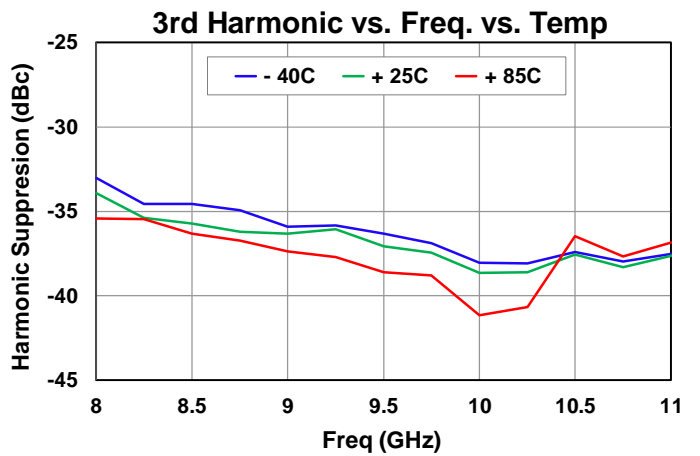
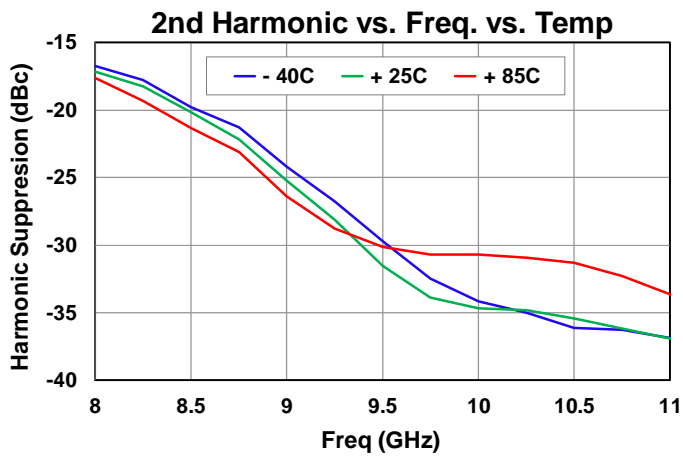
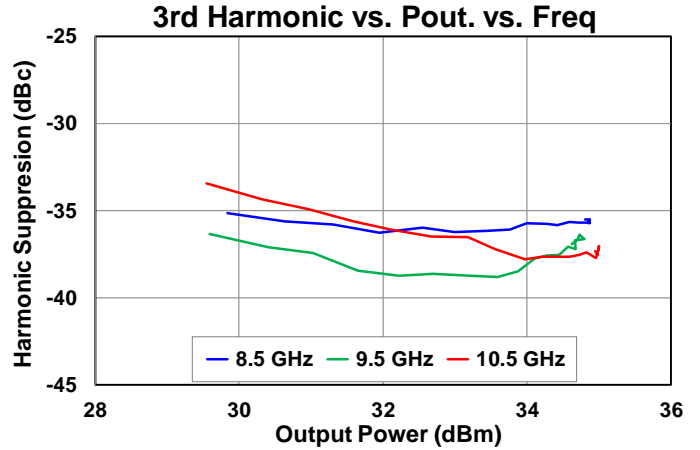
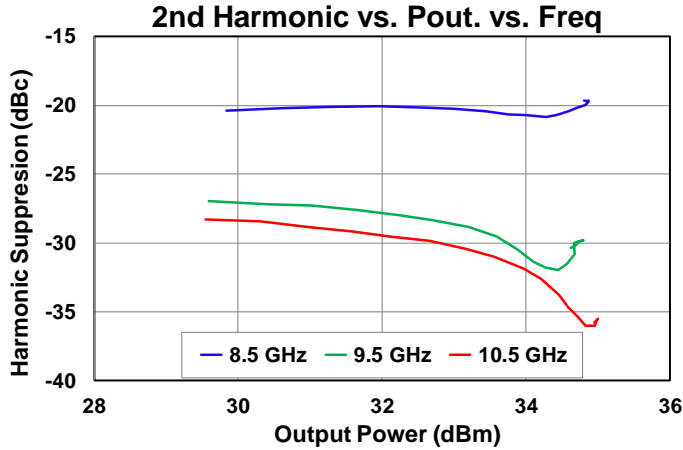

### Thermal and Reliability Information

Parameter	Test Conditions	Value	Units
Thermal Resistance ( $\theta_{JC}$ ) <sup>(1)</sup>	$T_{base} = 85\text{ }^{\circ}\text{C}$ , $V_D = 22\text{ V}$ , $I_{DQ} = 180\text{ mA}$ , $P_{DISS} = 3.96\text{ W}$ , CW, No RF (quiescent DC operation)	8.3	$^{\circ}\text{C/W}$
Channel Temperature, $T_{CH}$ (No RF) <sup>(2)</sup>		118	$^{\circ}\text{C}$
Thermal Resistance ( $\theta_{JC}$ ) <sup>(1)</sup>	$T_{base} = 85\text{ }^{\circ}\text{C}$ , $V_D = 22\text{ V}$ , $I_{DQ} = 180\text{ mA}$ , CW Freq = 9.5 GHz, $I_{D\_Drive} = 0.472\text{ A}$ , $P_{IN} = 18\text{ dBm}$ , $P_{OUT} = 36.4\text{ dBm}$ , $P_{DISS} = 6.08\text{ W}$	9.0	$^{\circ}\text{C/W}$
Channel Temperature, $T_{CH}$ (Under RF) <sup>(2)</sup>		140	$^{\circ}\text{C}$

**Notes:**

- Thermal resistance is referenced to the back of Cu-Mo carrier plate, assuming carrier thickness 20 mils, eutectic die attachment, back side of carrier temperature at 85 °C
- Refer to the following document: [GaN Device Channel Temperature, Thermal Resistance, and Reliability Estimates](#)

### Dissipated Power under RF Drive

Test conditions otherwise noted:  $V_D = 22\text{ V}$ ,  $I_{DQ} = 180\text{ mA}$ , CW, Temperature = +85 °C

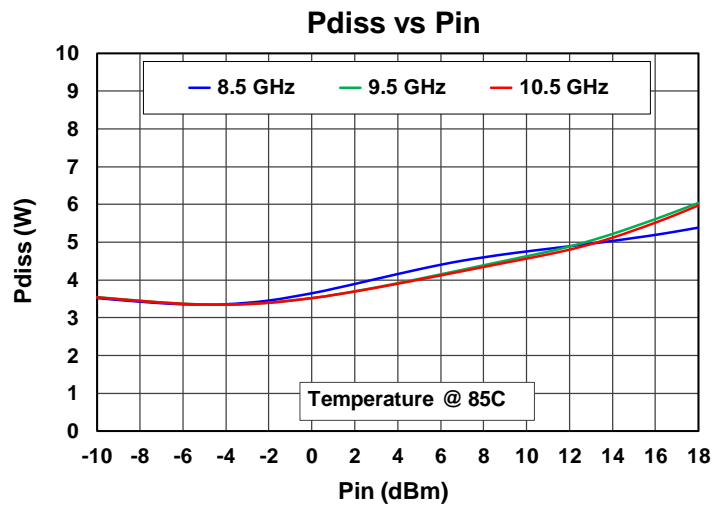

Applications Information

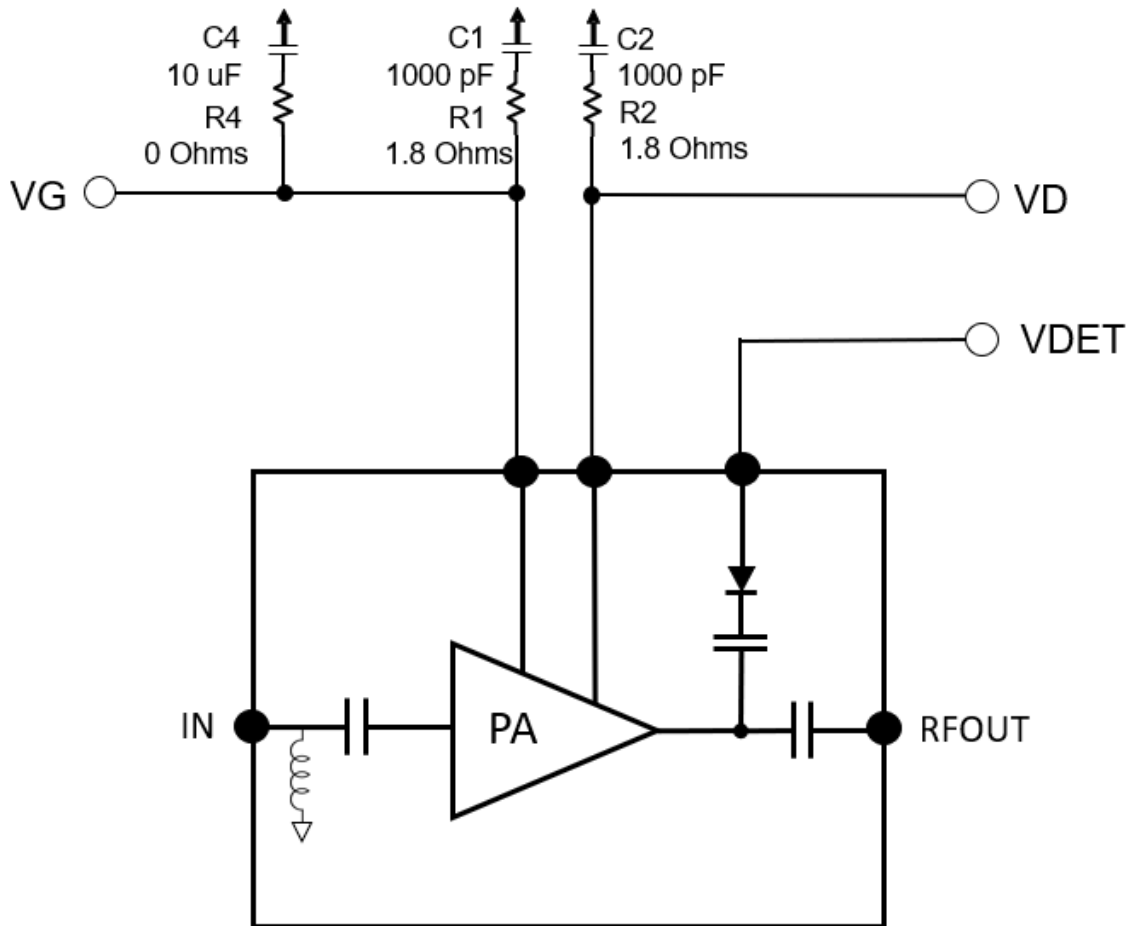

Bias-Up Procedure

1. Set  $I_D$  limit to 600 mA,  $I_G$  limit to 10 mA
2. Set  $V_G$  to -4.0 V
3. Set  $V_D$  +22 V
4. Adjust  $V_G$  more positive until  $I_{DQ} \approx 180$  mA
5. Apply RF signal

Bias-Down Procedure

1. Turn off RF signal
2. Reduce  $V_G$  to -4.0 V. Ensure  $I_{DQ} \sim 0$  mA
4. Set  $V_D$  to 0 V
5. Turn off  $V_D$  supply
6. Turn off  $V_G$  supply

**Evaluation Board (EVB) Layout Assembly**

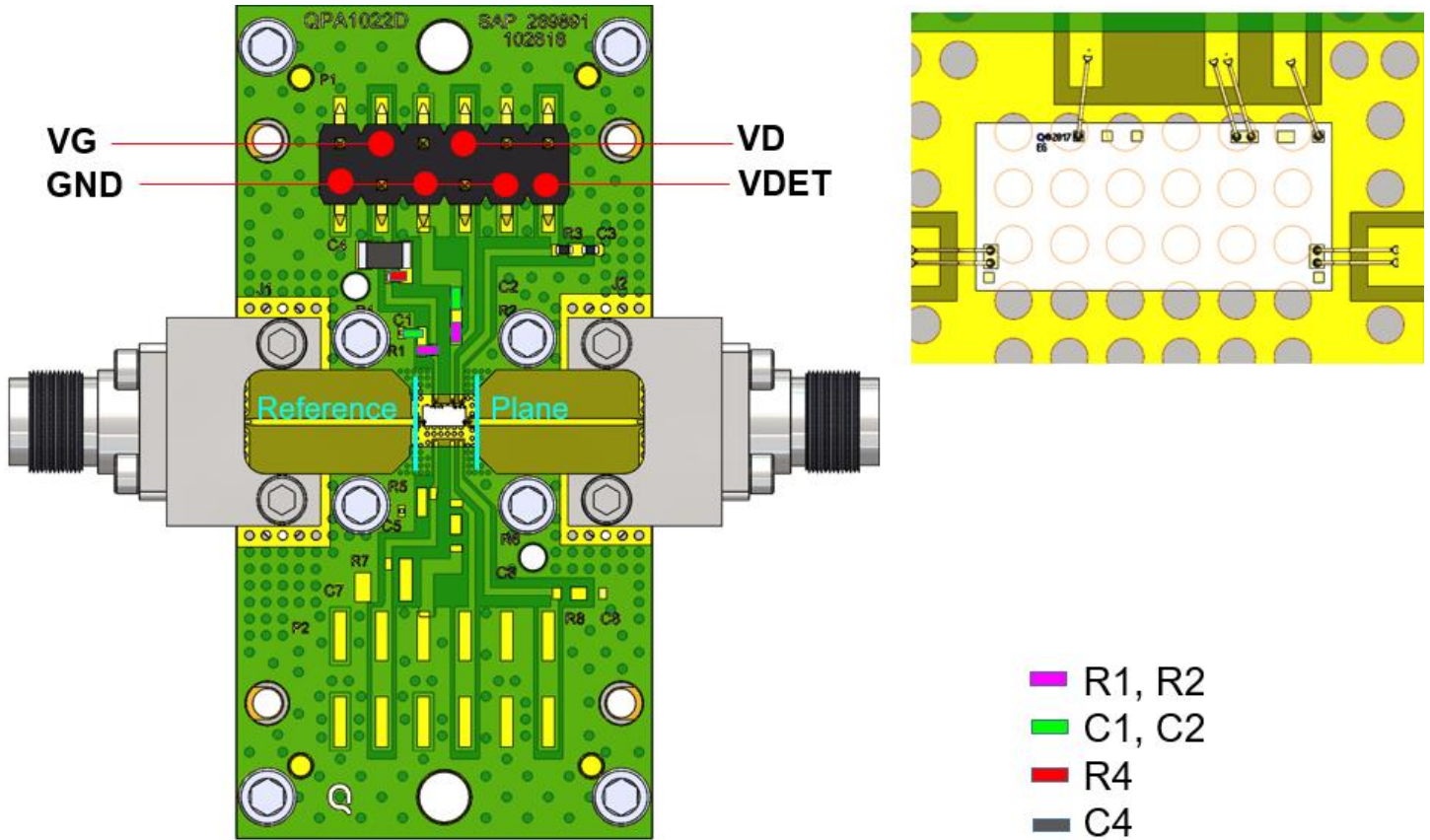

PCB is made from Rogers 4003C dielectric, 8 mil thickness, 0.5 oz. copper both sides.

**Bill of Materials**

Reference Des.	Value	Description	Manuf.	Part Number
C1, C2	1000 pF	CAP, 1000 pF, 20%, 50 V, 0402	Various	
R1, R2	1.8 Ohm	RES, 1.8 Ohm, 5%, 1/10 W, 0402	Various	
C4	10 uF	CAP, 10 uF, 20%, 50 V, 1206	Various	
R4	0 Ω	RES, 0 OHM, JMPR, 0402	Various	
J1, J2	2.92 mm	CONNECTOR, FEMALE, ENDLAUNCH	Southwest Microwave	1092-01A-5

**Mechanical Information**

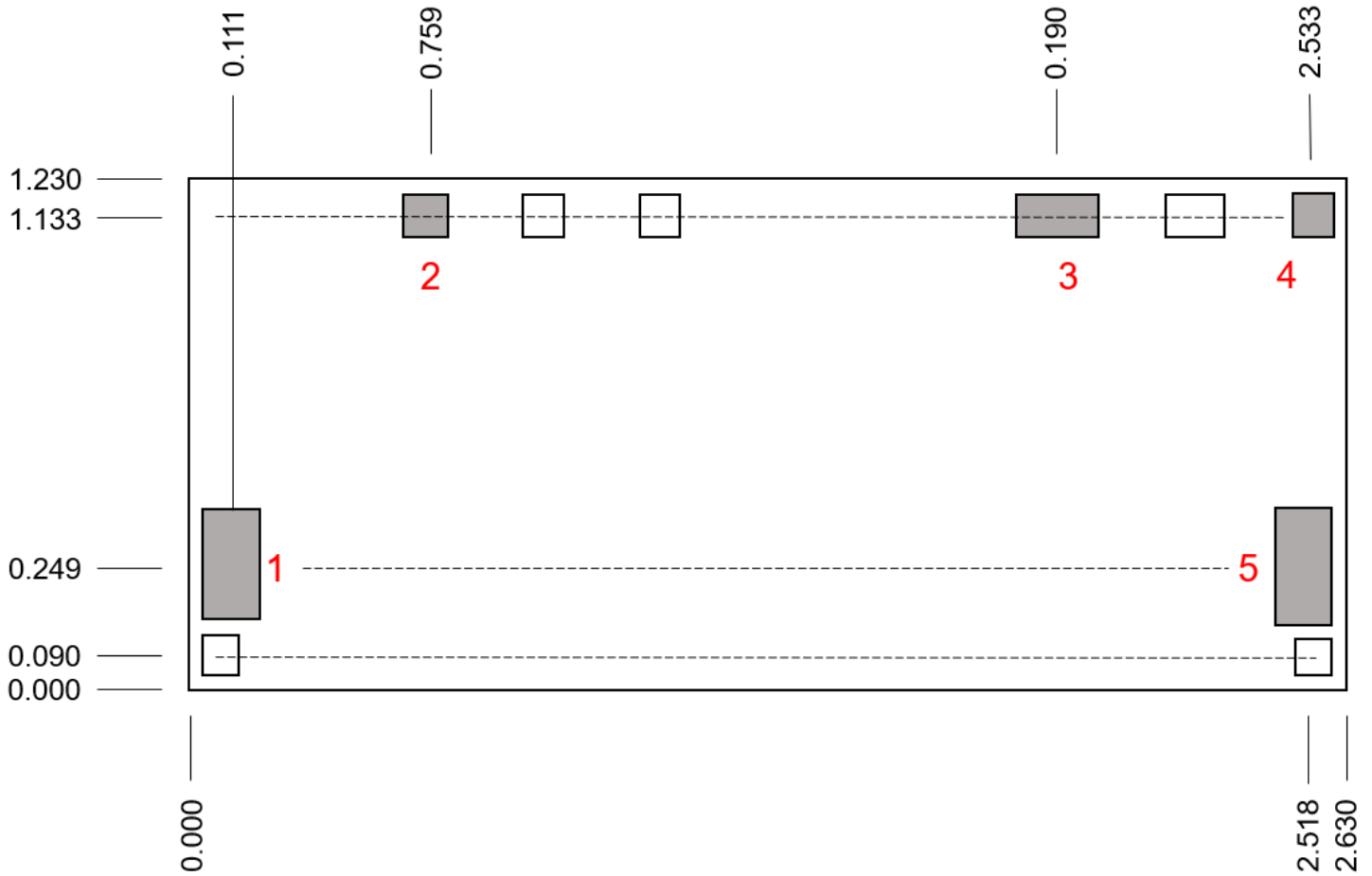

Dimensions are in mm  
Die thickness: 0.100  
Die x, y size tolerance: ± 0.050  
Ground is backside of die

**Bond Pad Description**

Pad No.	Symbol	Pad Size (mm)	Description
1	RF IN	0.113 x 0.183	RF input. 50 Ohms. DC grounded.
2	VG	0.083 x 0.083	Gate voltage. Bypass network required.
3	VD	0.208 x 0.093	Drain voltage. Bypass network required.
4	VDET	0.090 x 0.090	Power detection. Bias not required.
5	RF OUT	0.113 x 0.183	RF output. 50 Ohms. DC blocked.

## Assembly Notes

---

Component placement and adhesive attachment assembly notes:

- Vacuum pencils and/or vacuum collets are the preferred method of pick up.
- Air bridges must be avoided during placement.
- The force impact is critical during auto placement.

Reflow process assembly notes:

- Use AuSn (80/20) solder and limit exposure to temperatures above 300 °C to 3–4 minutes, maximum.
- An alloy station or conveyor furnace with reducing atmosphere should be used.
- Do not use any kind of flux.
- Coefficient of thermal expansion matching is critical for long-term reliability.
- Devices must be stored in a dry nitrogen atmosphere.

Interconnect process assembly notes:

- Thermosonic ball bonding is the preferred interconnect technique.
- Force, time, and ultrasonic are critical parameters.
- Aluminum wire should not be used.
- Devices with small pad sizes should be bonded with 0.0007-inch wire.