

Product Overview

Qorvo's QPA2612 is a packaged, high performance power amplifier fabricated on Qorvo's production 0.15 um GaN on SiC process (QGaN15). Covering 8 - 12 GHz, the QPA2612 provides > 12 W of saturated output power and 23 dB of large-signal gain while achieving an impressive 40% power-added efficiency.

Packaged in a small 5 x 5 mm plastic overmold QFN, tight lattice spacing requirements for phased array radar applications is easily supported. RF input and output ports are matched to 50Ω and are DC grounded. QPA2612 is part of a three-amplifier family and is pin compatible to QPA2610 and QPA2611.

Lead-free and RoHS compliant.

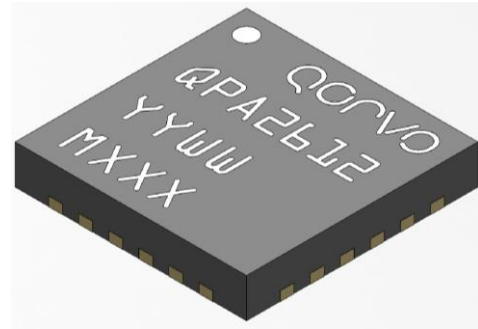

5 mm x 5 mm plastic overmold QFN

Key Features

- Frequency Range: 8.0 – 12.0 GHz
- Output Power ($P_{IN} = 18 \text{ dBm}$): > 41 dBm
- PAE ($P_{IN} = 18 \text{ dBm}$): > 40 %
- Small Signal Gain: 34 dB
- Input Return Loss: > 16 dB
- Output Return Loss: > 4 dB
- Recommended Bias: $V_D = 24 \text{ V}$, $I_{DQ} = 250 \text{ mA}$
- Package Size: 5.0 mm x 5.0 mm x 0.85 mm

Functional Block Diagram

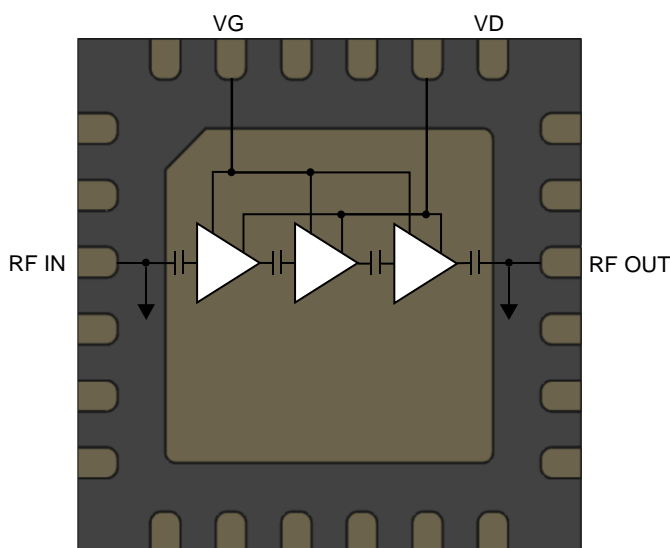

Top View

Applications

- Radar
- Communications
- Satcom

Ordering Information

Part No.	Description
QPA2612	12 Watt X-Band Power Amplifier
QPA2612TR7	250 pcs. on 7 inch reel
QPA2612EVB	QPA2612 Evaluation Board

Absolute Maximum Ratings

Parameter	Rating
Drain Voltage (V_D)	29.5 V
Gate Voltage Range (V_G)	-4 to 0 V
Drain Current (I_D)	1700 mA
Gate Current (I_G)	See plot pg. 16
Power Dissipation (P_{DISS}), CW, 85 °C	26.8 W
Input Power (P_{IN}), CW, 50 Ω , 85 °C	21 dBm
Input Power (P_{IN}), CW, VSWR 4:1, $V_D = 24$ V, 85 °C	21 dBm
Mounting Temperature (30 seconds max.)	260 °C
Storage Temperature	-55 to 150 °C

Exceeding any one or a combination of the Absolute Maximum Rating conditions may cause permanent damage to the device. Extended application of Absolute Maximum Rating conditions to the device may reduce device reliability.

Recommended Operating Conditions

Parameter	Typ
Drain Voltage (V_D)	24 V
Drain Current (I_{DQ})	250 mA
Drain Current Under RF Drive (I_{D_DRIVE})	See plots pg. 4
Gate Voltage Range (V_G)	-2.8 to -2.0 V
Gate Current Under RF Drive (I_{G_DRIVE})	See plots pg. 4

Electrical specifications are measured at specified test conditions. Specifications are not guaranteed over all recommended operating conditions.

Electrical Specifications

Parameter	Conditions	Min	Typ	Max	Units
Operational Frequency		8		12	GHz
Output Power ($P_{IN} = 18$ dBm)	Pulsed V_D		41.7		dBm
Power Added Efficiency ($P_{IN} = 18$ dBm)	Pulsed V_D		43.5		%
Small Signal Gain (CW)			34.2		dB
Input Return Loss (CW)			21		dB
Output Return Loss (CW)			6		dB
3 RD Order IMD ($P_{IN}/Tone = 5$ dBm)	10 MHz tone spacing		-14		dBc
P_{OUT} Temp. Coeff. (85 °C to 25 °C, $P_{IN} = 18$ dBm)			-0.003		dB/°C
Sm. Sig. Gain Temp. Coefficient (85 °C to -40 °C)			-0.105		dB/°C
Gate Leakage Current	$V_D = 10$ V, $V_G = -3.7$ V	-5.37			mA

Test conditions, unless otherwise noted: $T = +25$ °C, $V_D = 24$ V, $I_{DQ} = 250$ mA, Pulse Width = 100 us, Duty Cycle = 10%

Performance Plots – Large Signal (Pulsed)

Test conditions unless otherwise noted: $T = +25\text{ }^{\circ}\text{C}$, $V_D = 24\text{ V}$, $I_{DQ} = 250\text{ mA}$, $P_{IN} = 18\text{ dBm}$, Pulse Width = 100 μs , Duty Cycle = 10%

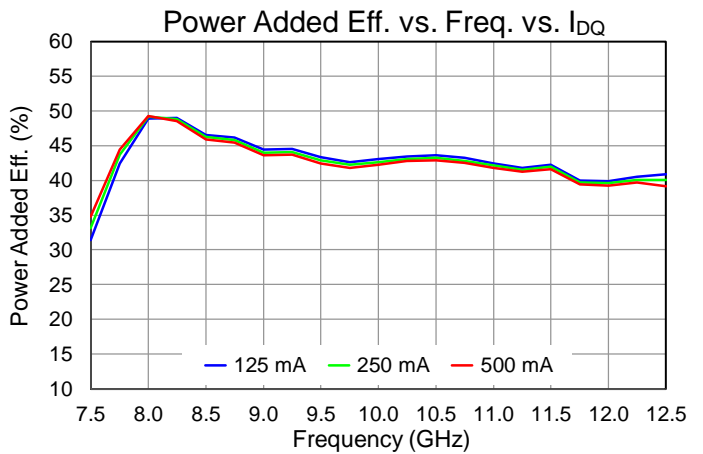
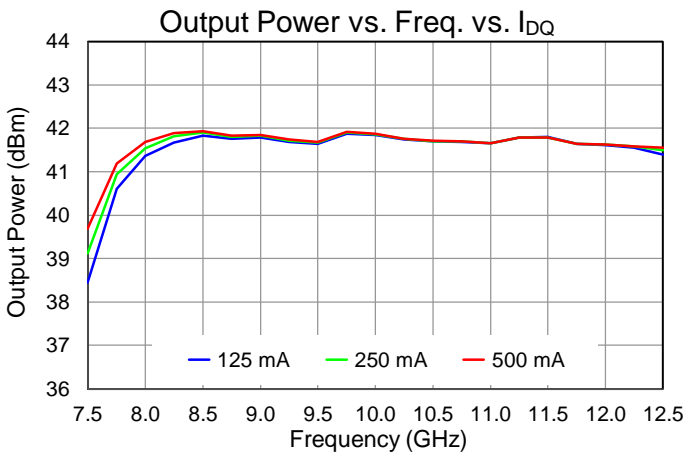
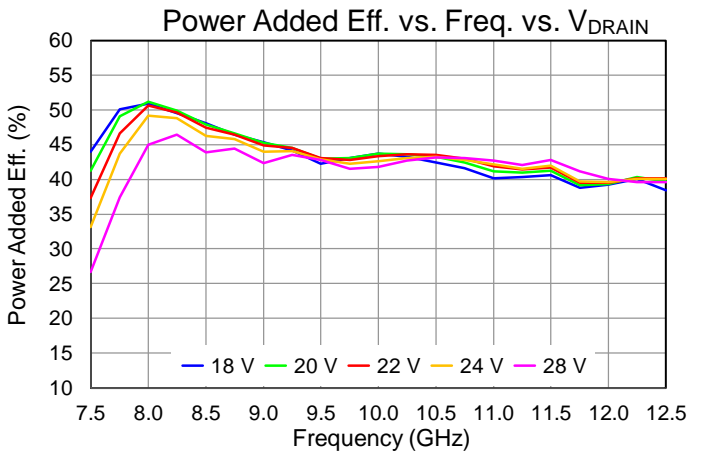
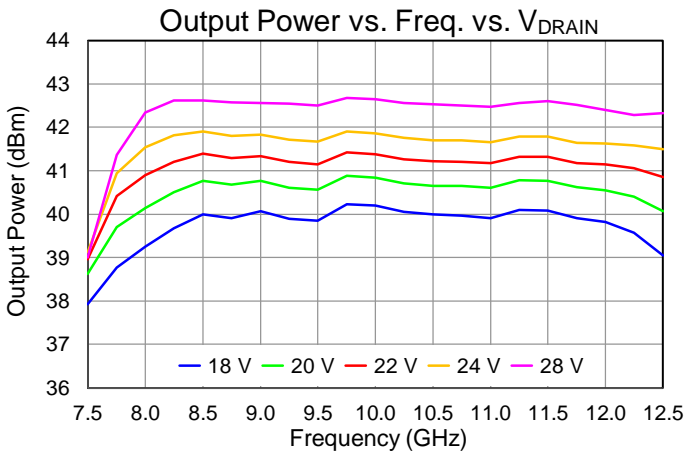
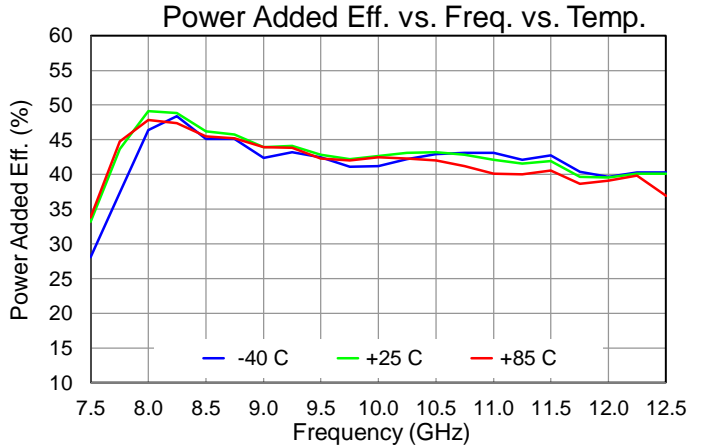
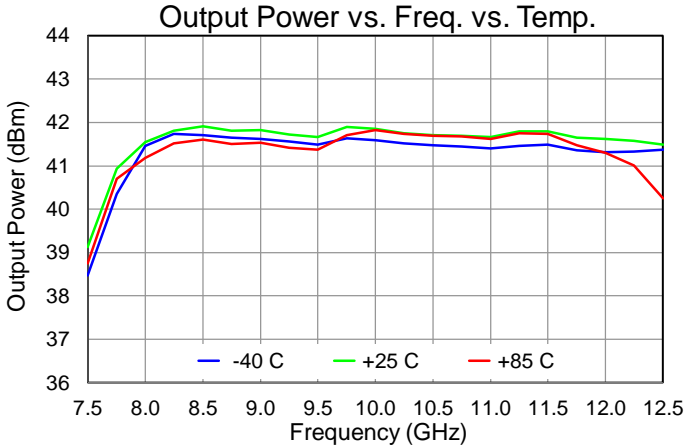

Performance Plots – Large Signal (Pulsed)

Test conditions unless otherwise noted: $T = +25\text{ }^{\circ}\text{C}$, $V_D = 24\text{ V}$, $I_{DQ} = 250\text{ mA}$, $P_{IN} = 18\text{ dBm}$, Pulse Width = 100 μs , Duty Cycle = 10%

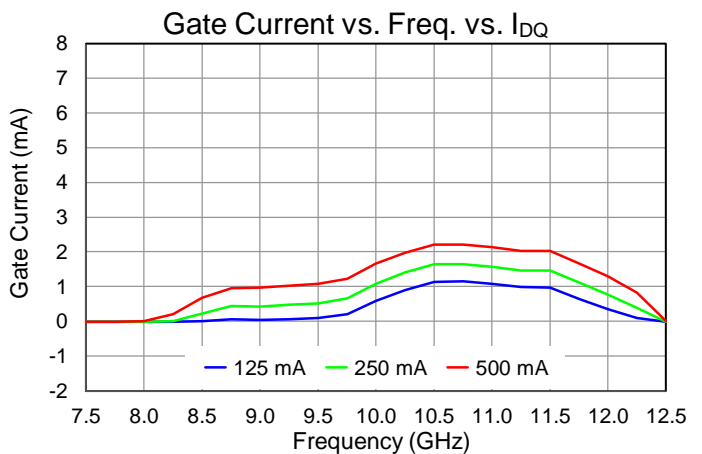
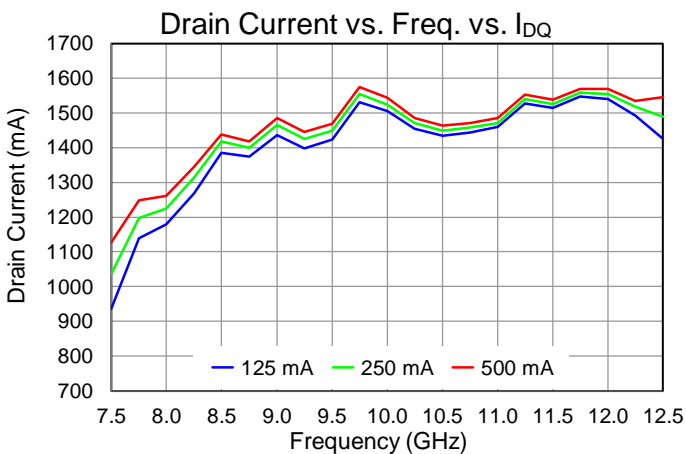
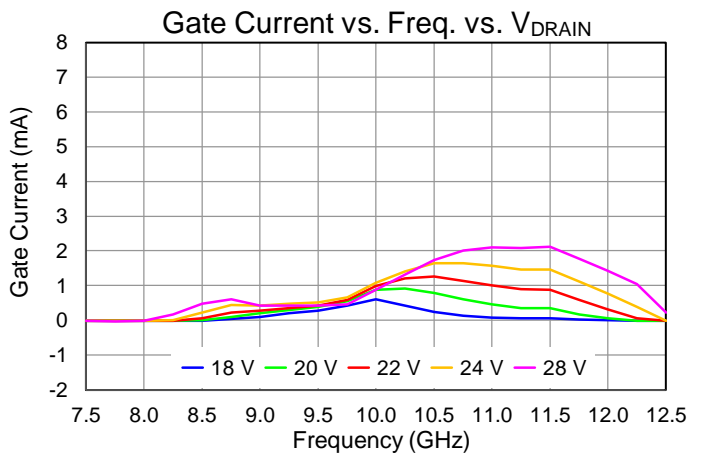
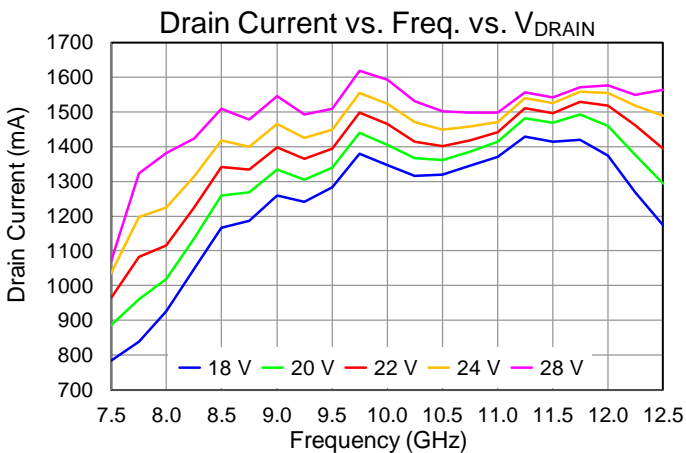
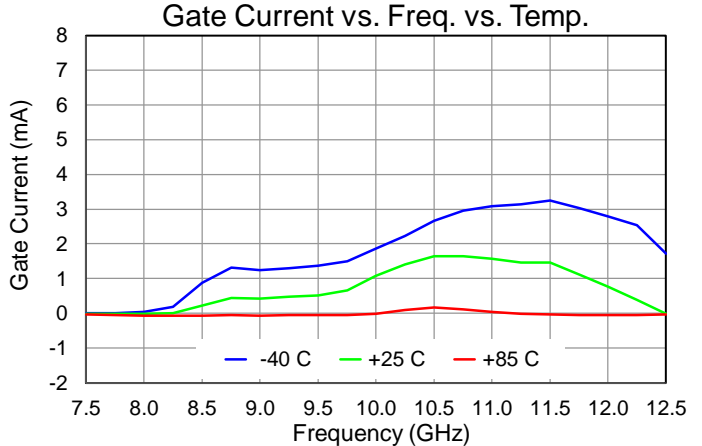
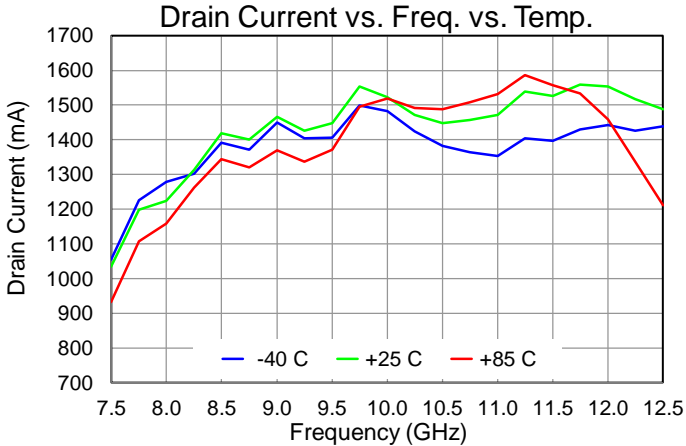

Performance Plots – Large Signal (Pulsed)

Test conditions unless otherwise noted: $T = +25\text{ }^{\circ}\text{C}$, $V_D = 24\text{ V}$, $I_{DQ} = 250\text{ mA}$, Pulse Width = 100 us, Duty Cycle = 10%

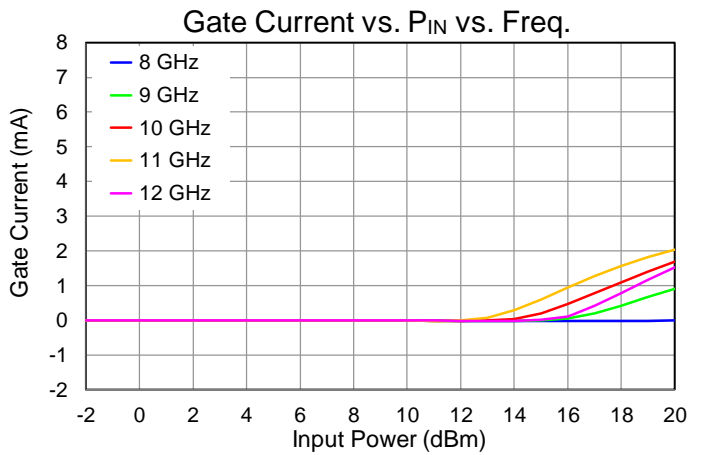
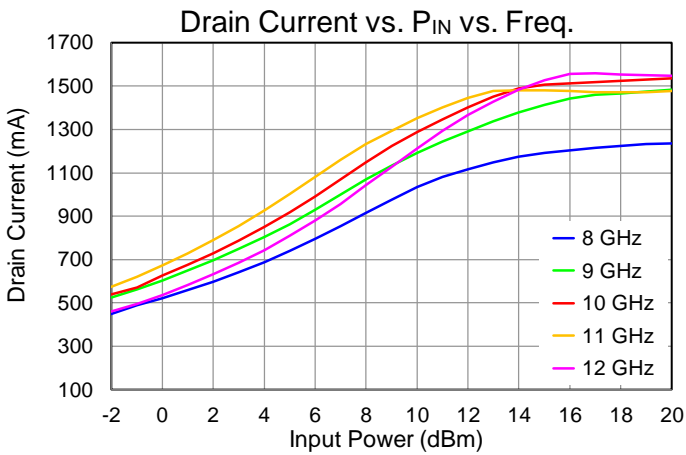
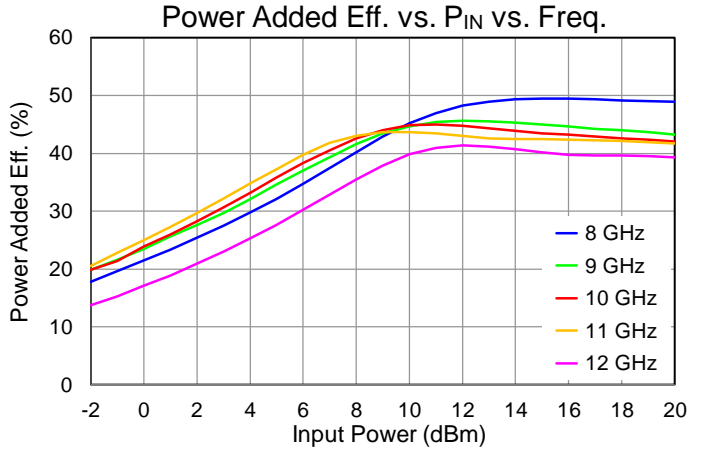
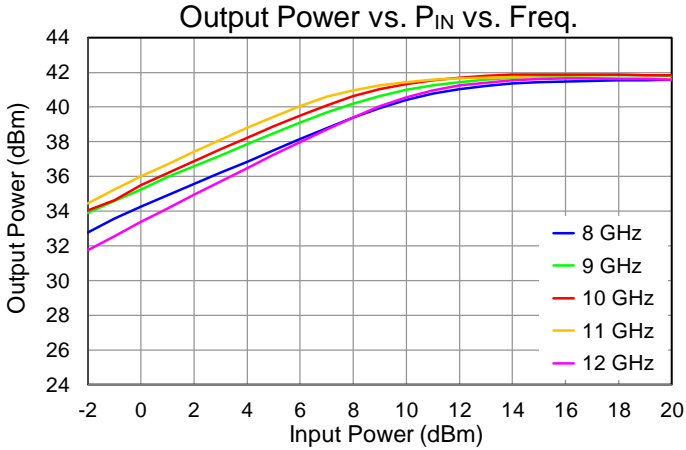

Performance Plots – Large Signal (Pulsed)

Test conditions unless otherwise noted: T = +25 °C, V_D = 24 V, I_{DQ} = 250 mA, Pulse Width = 100 us, Duty Cycle = 10%

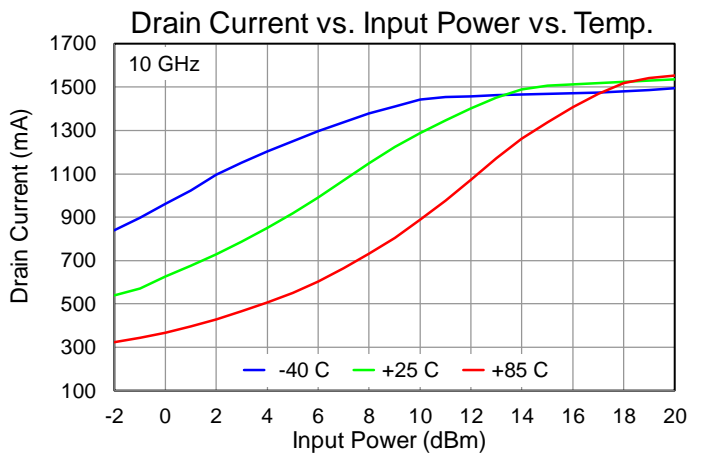
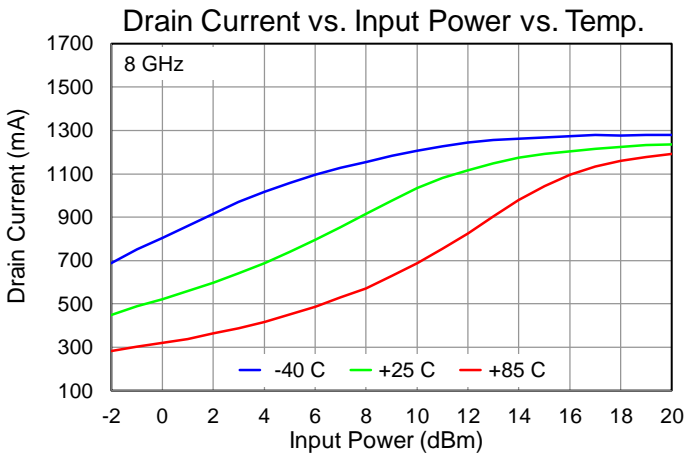
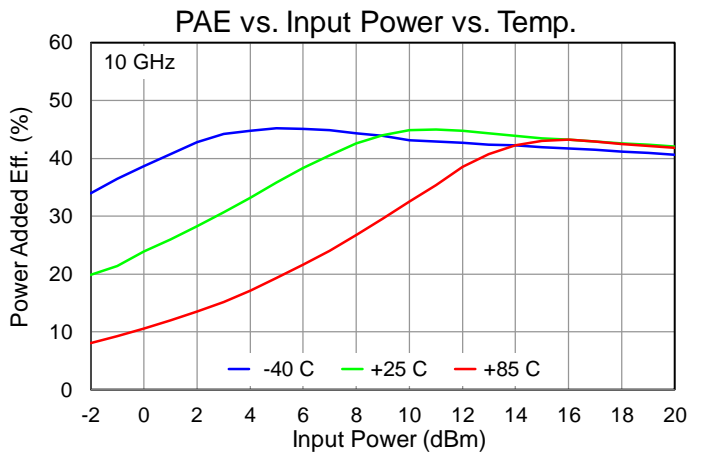
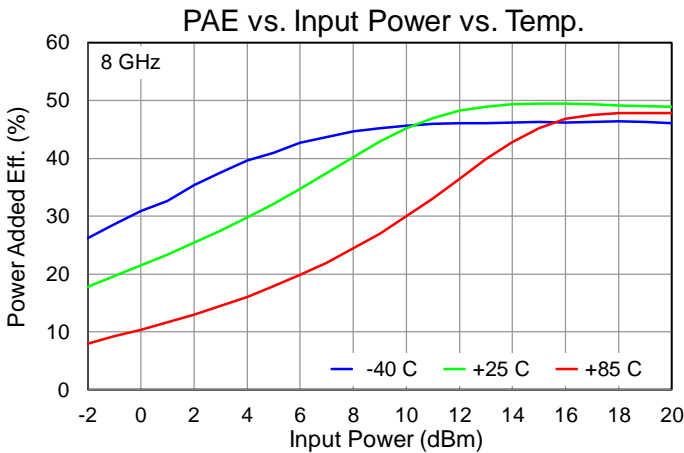
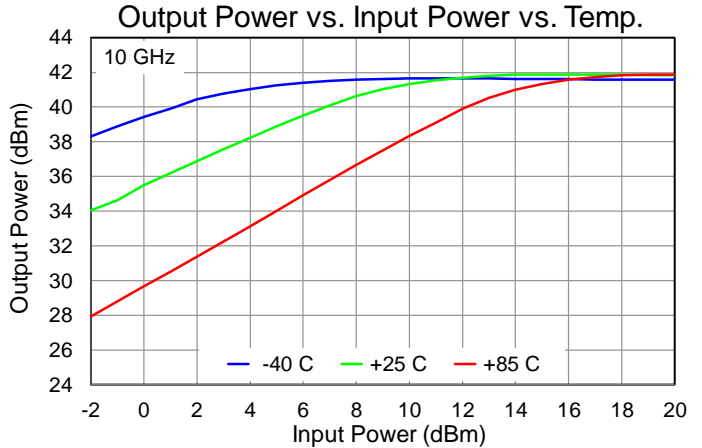
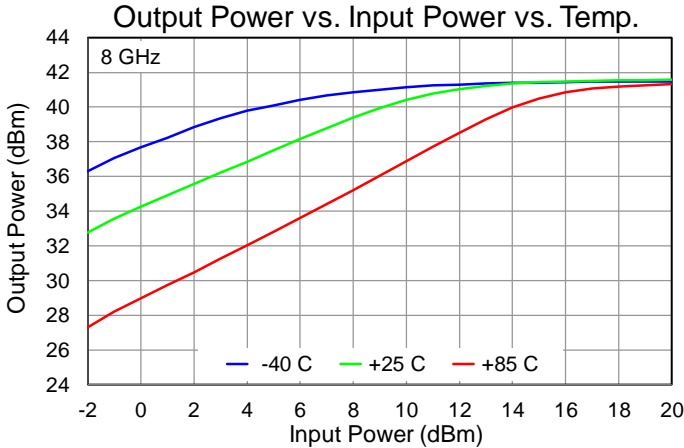

Performance Plots – Large Signal (Pulsed)

Test conditions unless otherwise noted: T = +25 °C, V_D = 24 V, I_{DQ} = 250 mA, Pulse Width = 100 us, Duty Cycle = 10%

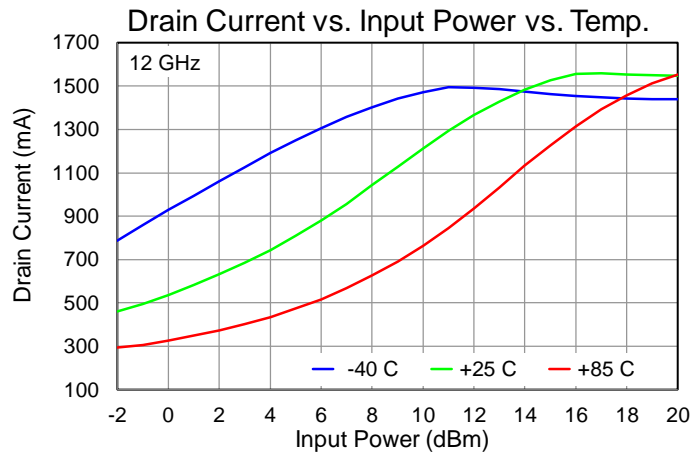
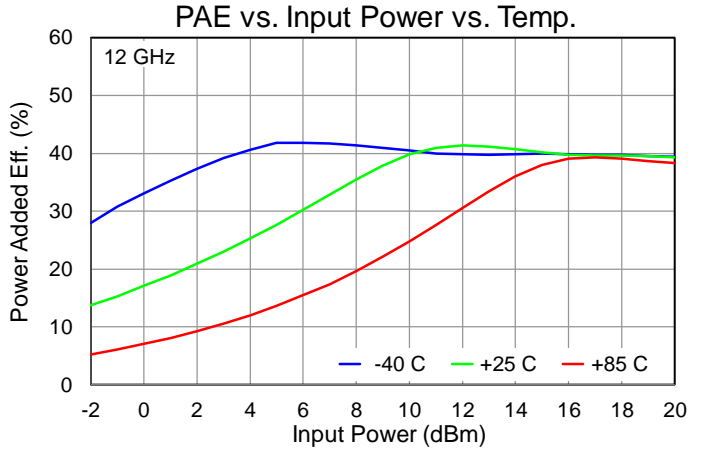
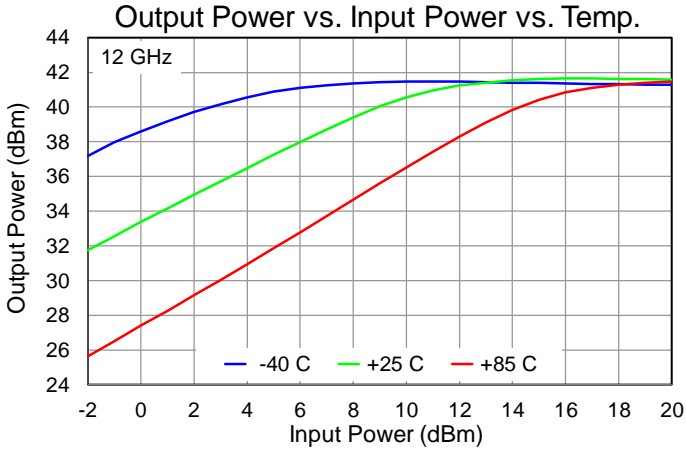

Performance Plots – Large Signal (Pulsed)

Test conditions unless otherwise noted: $T = +25\text{ }^{\circ}\text{C}$, $V_D = 24\text{ V}$, $I_{DQ} = 250\text{ mA}$, Pulse Width = 100 us, Duty Cycle = 10%

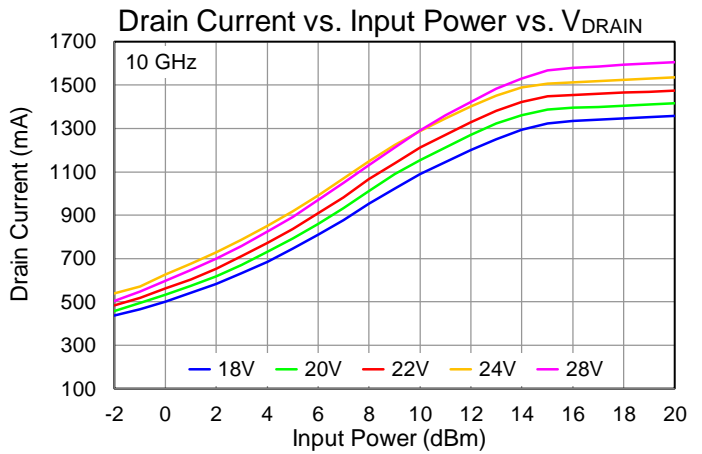
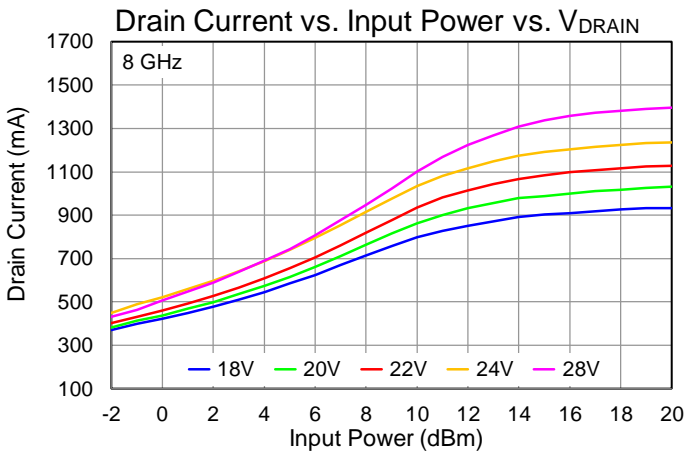
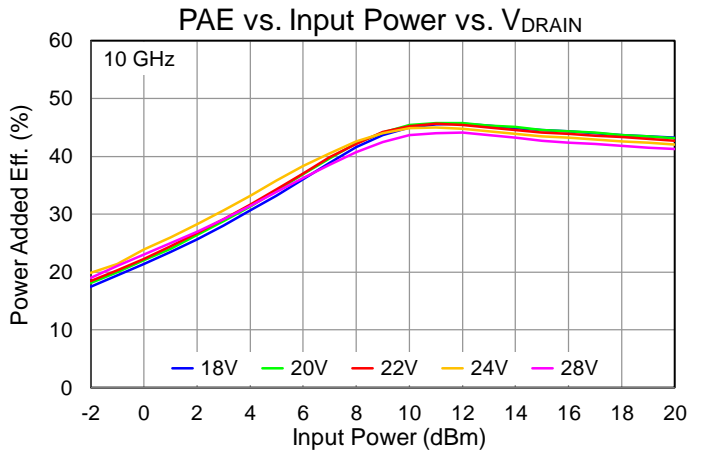
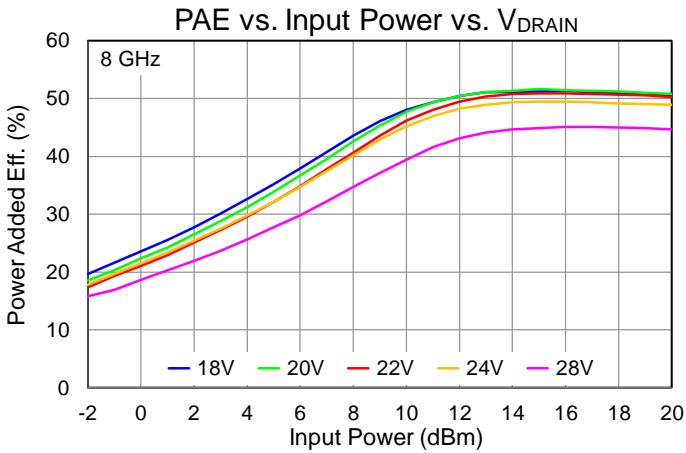
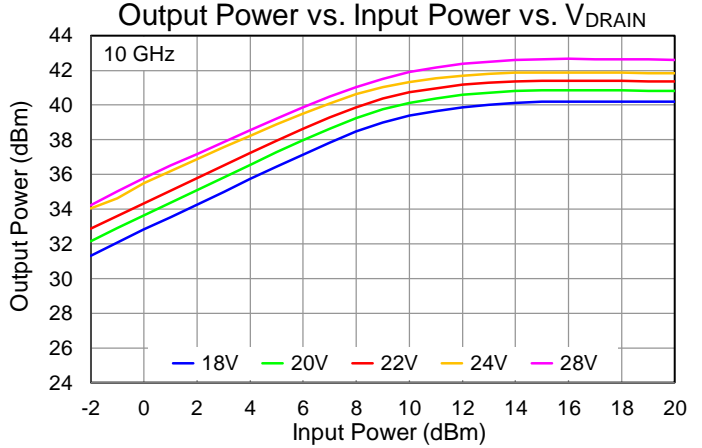
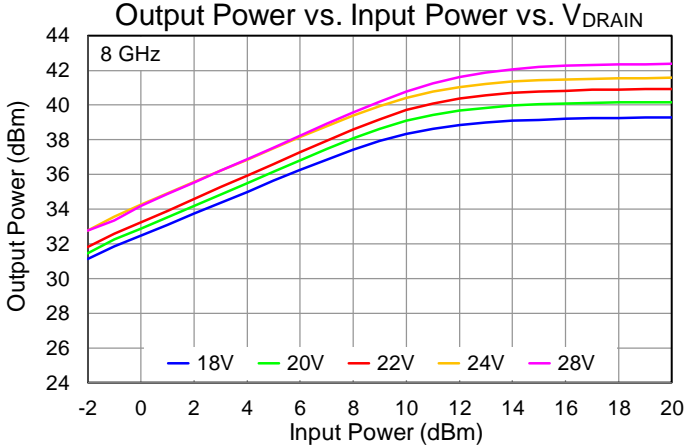

Performance Plots – Large Signal (Pulsed)

Test conditions unless otherwise noted: T = +25 °C, V_D = 24 V, I_{DQ} = 250 mA, Pulse Width = 100 us, Duty Cycle = 10%

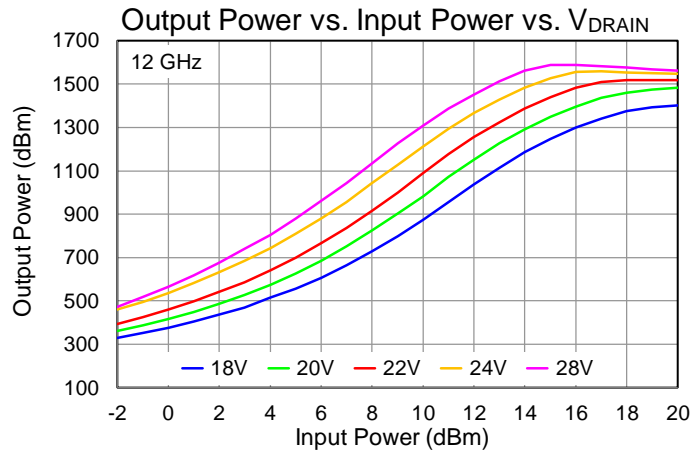
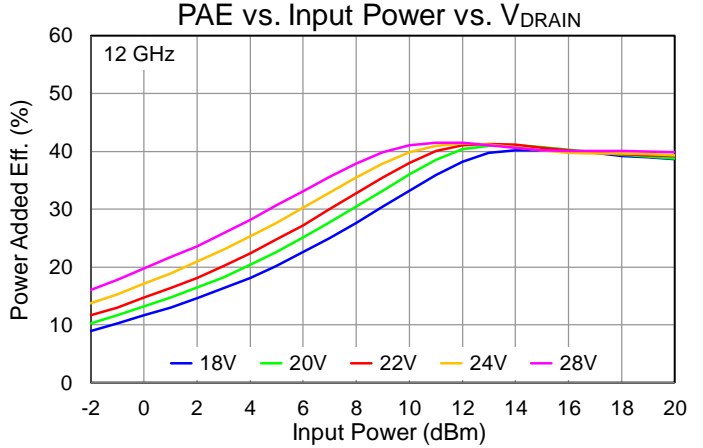
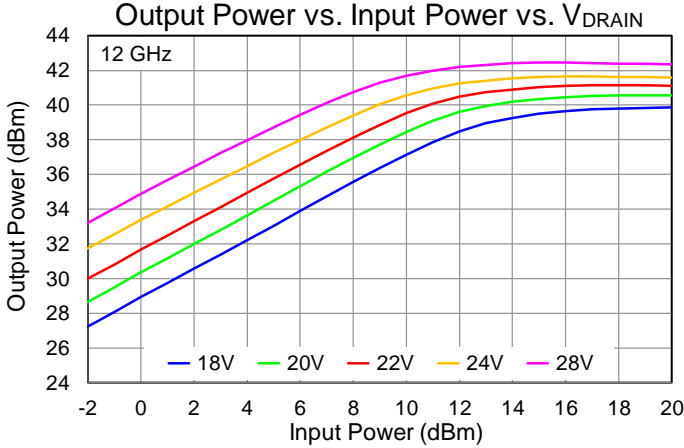

Performance Plots – Large Signal (Pulsed)

Test conditions unless otherwise noted: $T = +25\text{ }^{\circ}\text{C}$, $V_D = 24\text{ V}$, $I_{DQ} = 250\text{ mA}$, Pulse Width = 100 us, Duty Cycle = 10%

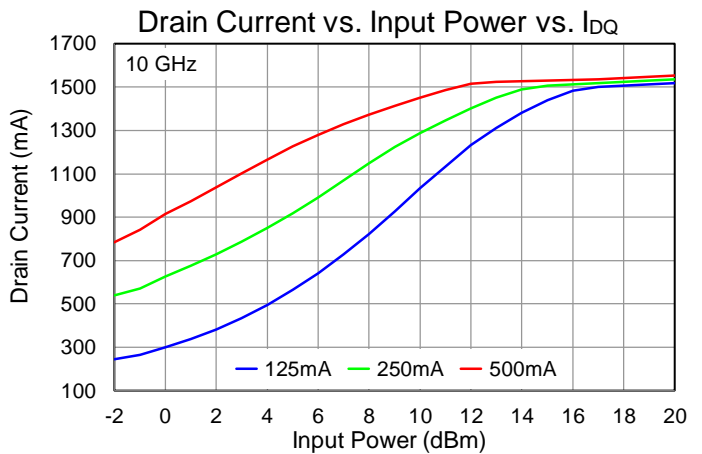
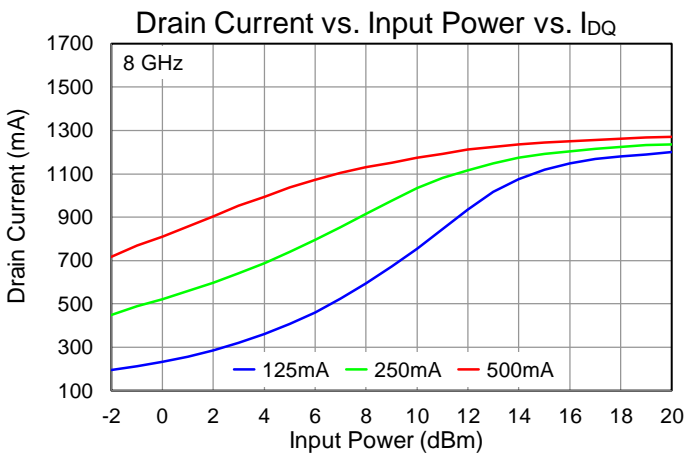
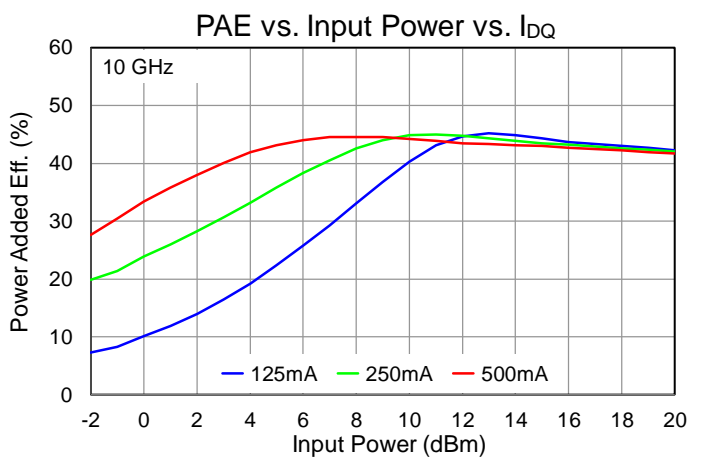
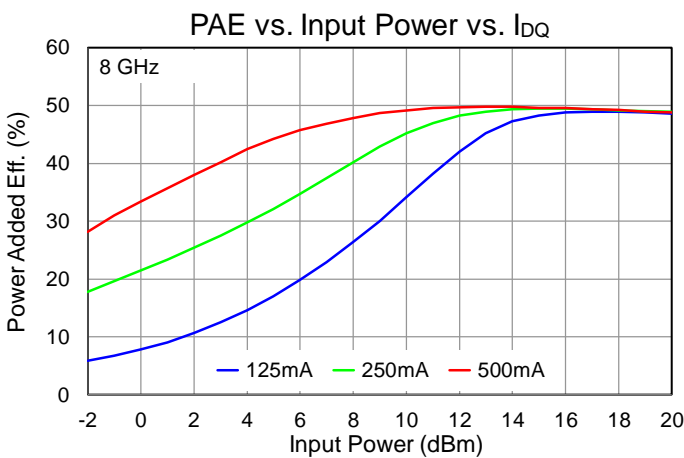
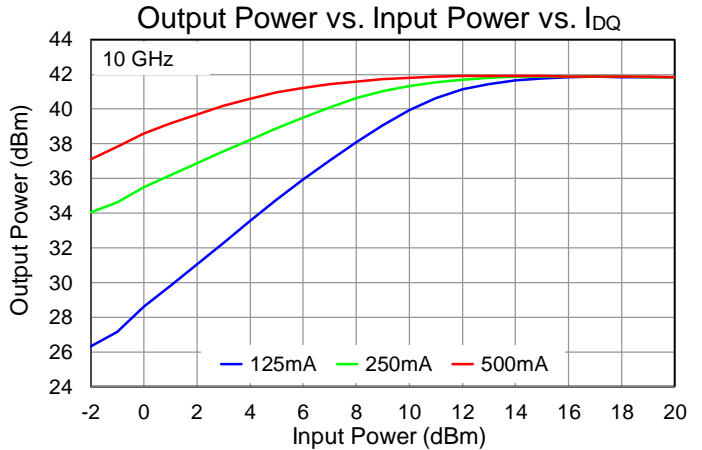
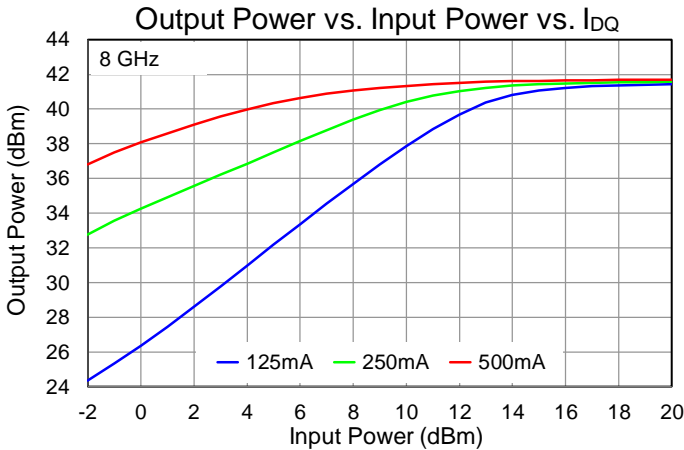

Performance Plots – Large Signal (Pulsed)

Test conditions unless otherwise noted: T = +25 °C, V_D = 24 V, I_{DQ} = 250 mA, Pulse Width = 100 us, Duty Cycle = 10%

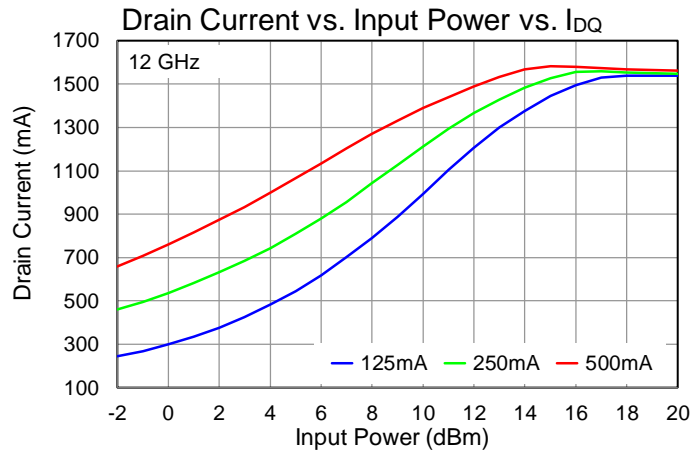
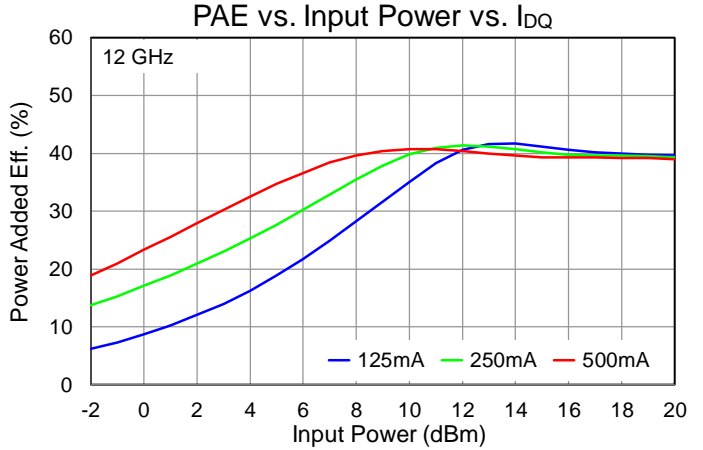
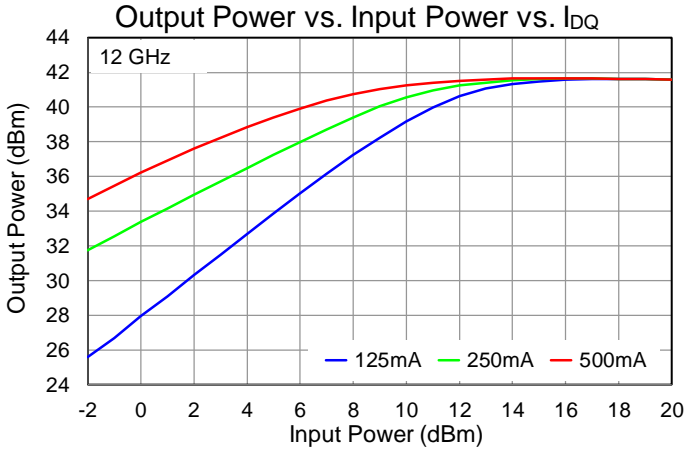

Performance Plots – Linearity

Test conditions unless otherwise noted: $V_D = 24\text{ V}$, $I_{BQ} = 250\text{ mA}$, $T = 25\text{ }^\circ\text{C}$, 10 MHz Tone Spacing, CW

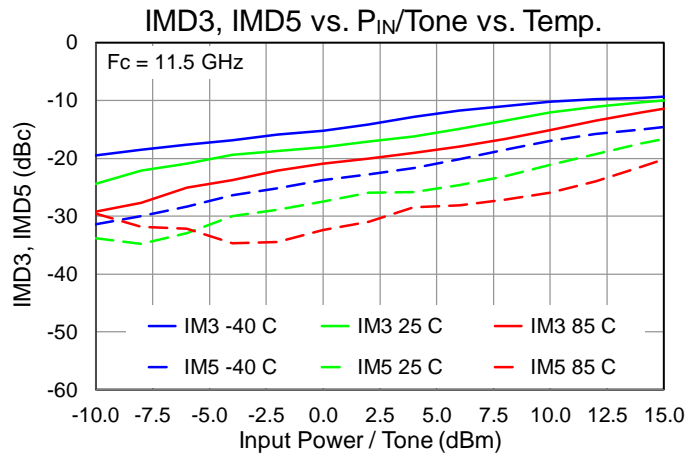
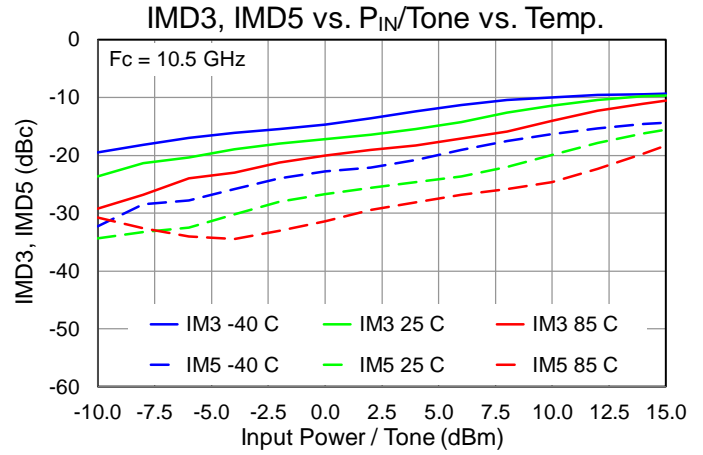
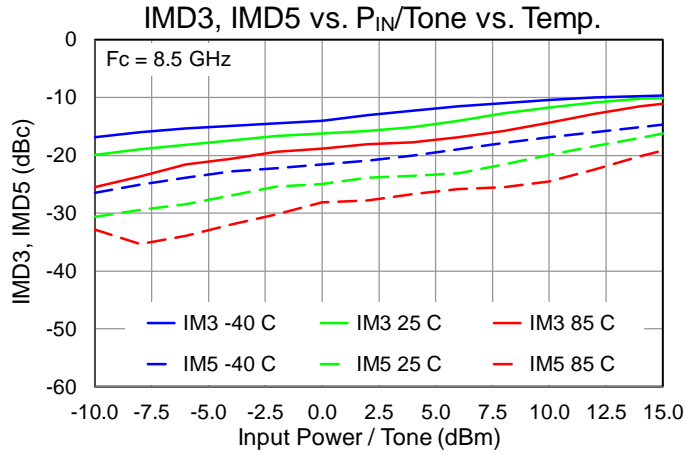

Performance Plots – Harmonics

Test conditions unless otherwise noted: T = +25 °C, V_D = 24 V, I_{DQ} = 250 mA, Pulse Width = 100 us, Duty Cycle = 10%

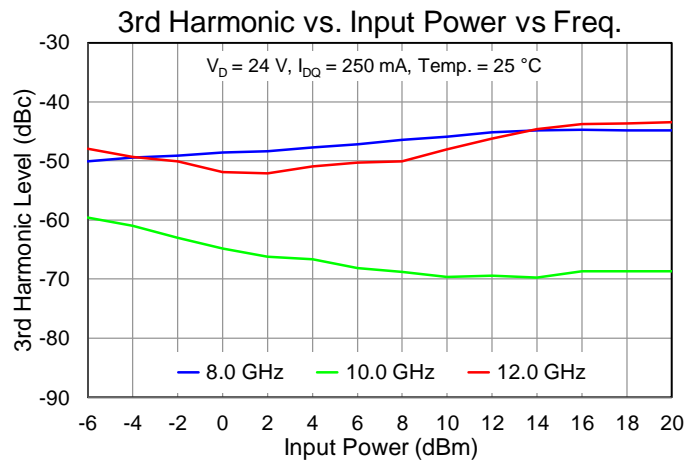
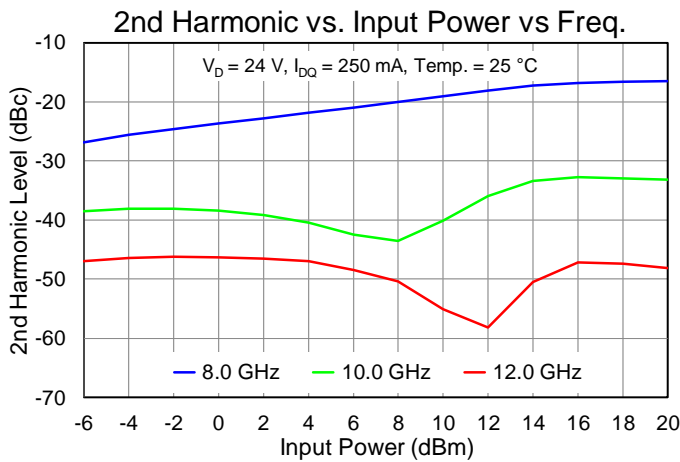
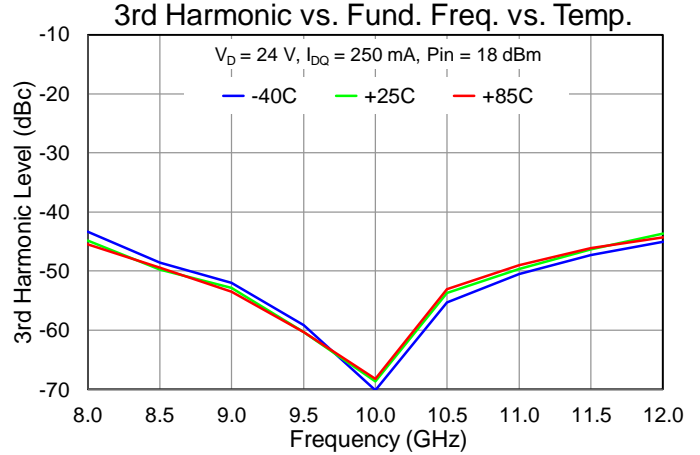
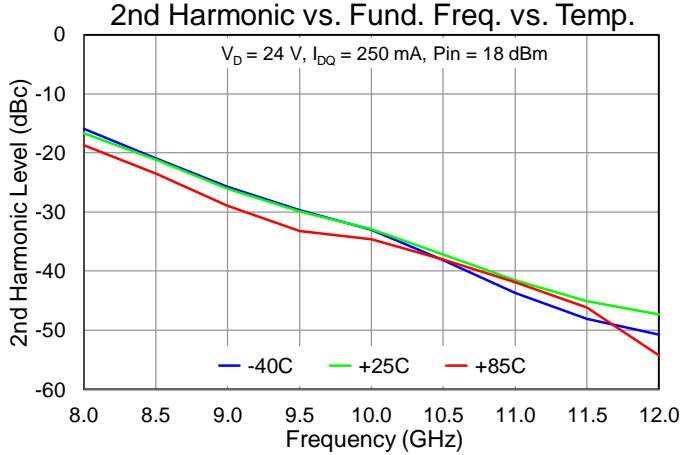

Performance Plots – Small Signal

Test conditions unless otherwise noted: T = +25 °C, V_D = 24 V, I_{DQ} = 250 mA, CW

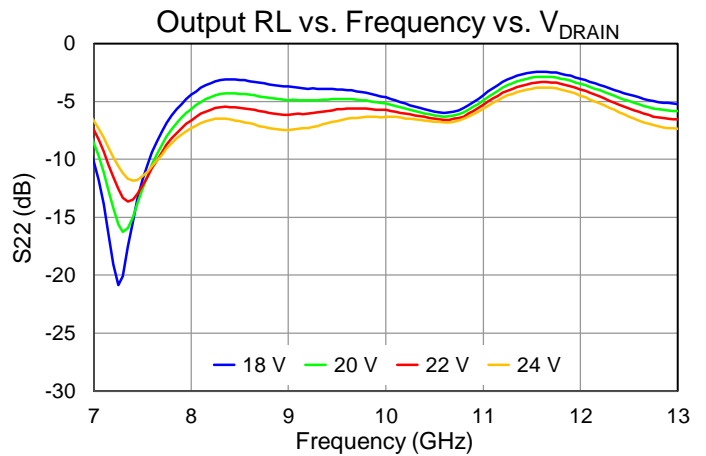
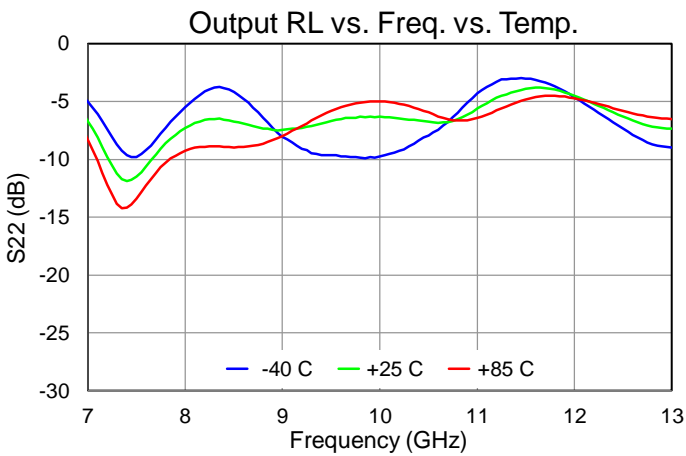
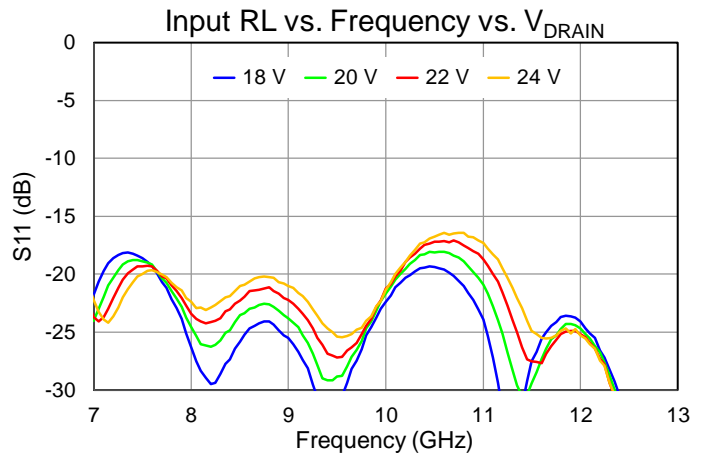
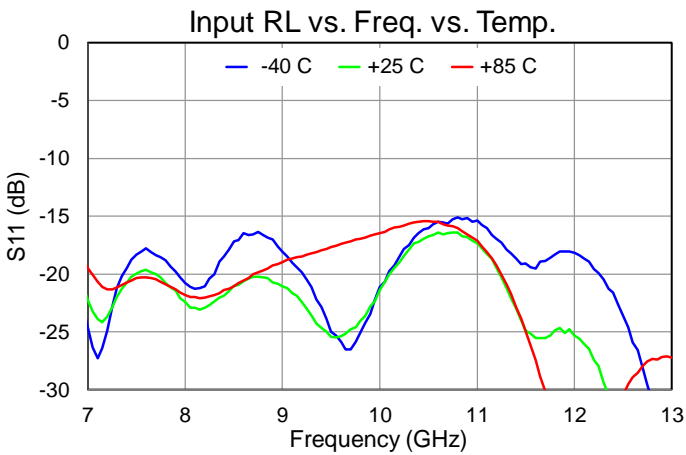
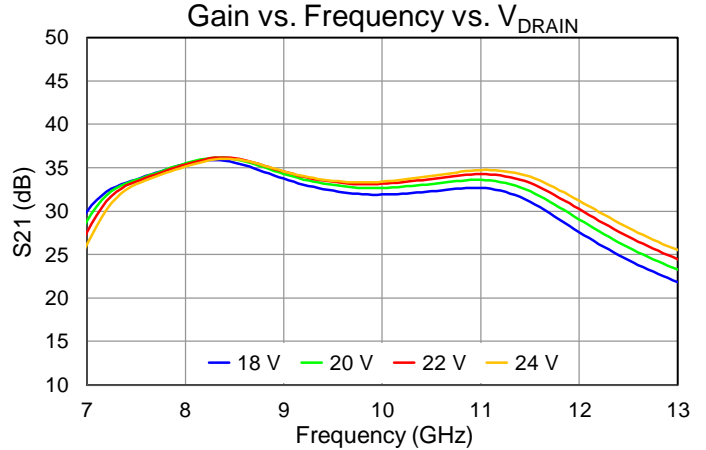
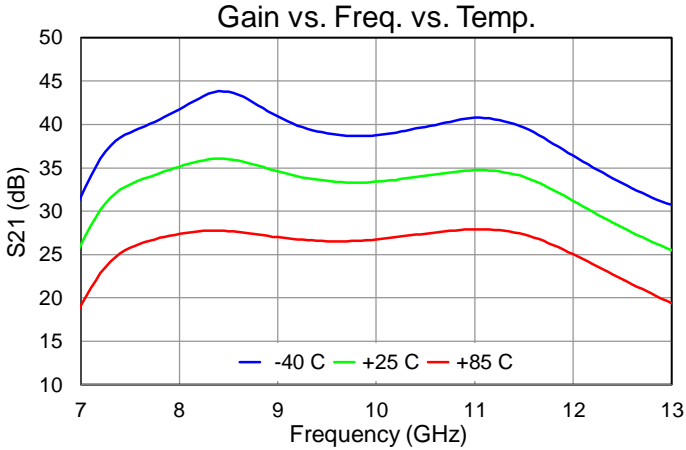

Performance Plots – Small Signal

Test conditions unless otherwise noted: T = +25 °C, V_D = 24 V, I_{DQ} = 250 mA, CW

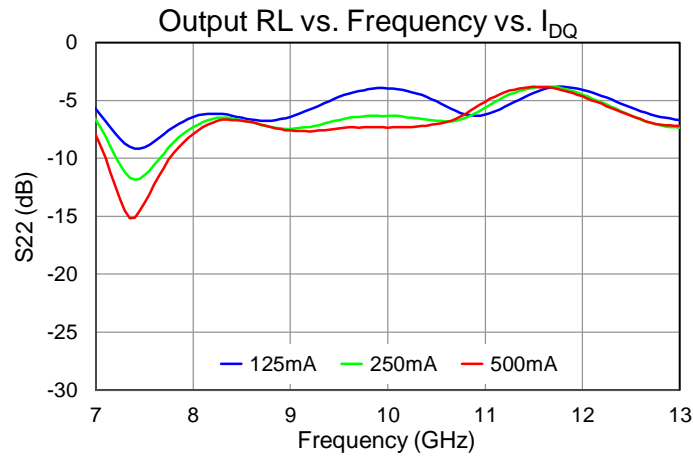
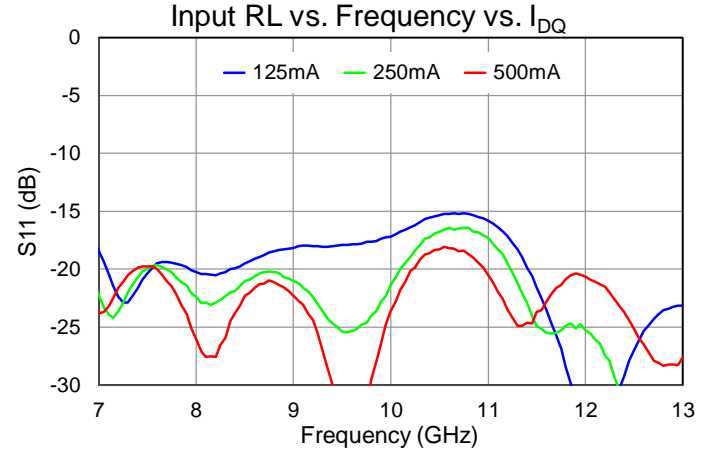
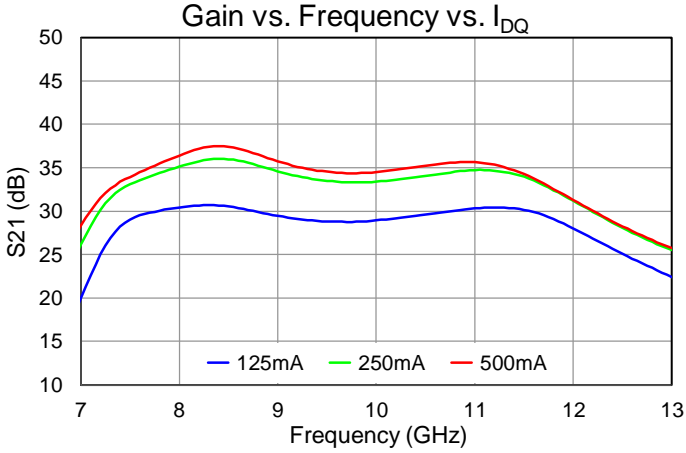

Thermal and Reliability Information

Parameter	Test Conditions	Value	Units
Thermal Resistance (θ_{JC}) ⁽¹⁾	$T_{base} = +85\text{ }^{\circ}\text{C}$, $V_D = 24\text{ V}$, $I_{DQ} = 250\text{ mA}$, $P_{DISS} = 6.0\text{ W}$ (CW, quiescent, no RF)	3.563	$^{\circ}\text{C}/\text{W}$
Channel Temperature, T_{CH} (Under RF) ⁽²⁾		106.4	$^{\circ}\text{C}$
Thermal Resistance (θ_{JC}) ⁽¹⁾	$T_{base} = +85\text{ }^{\circ}\text{C}$, $V_D = 24\text{ V}$, $I_{DQ} = 250\text{ mA}$, $I_{D_Drive} = 1586\text{ mA}$, $P_{OUT} = 41.8\text{ dBm}$, $P_{IN} = 18\text{ dBm}$, Freq. = 11.25 GHz, $P_{DISS} = 22.4\text{ W}$ (Pulse: 100us/10%)	2.834	$^{\circ}\text{C}/\text{W}$
Channel Temperature, T_{CH} (Under RF) ⁽²⁾		148.5	$^{\circ}\text{C}$
Thermal Resistance (θ_{JC}) ⁽¹⁾	$T_{base} = +85\text{ }^{\circ}\text{C}$, $V_D = 28\text{ V}$, $I_{DQ} = 250\text{ mA}$, $I_{D_Drive} = 1663\text{ mA}$, $P_{OUT} = 42.8\text{ dBm}$, $P_{IN} = 18\text{ dBm}$, Freq. = 11.25 GHz, $P_{DISS} = 26.8\text{ W}$ (Pulse: 100us/10%)	2.794	$^{\circ}\text{C}/\text{W}$
Channel Temperature, T_{CH} (Under RF) ⁽²⁾		159.9	$^{\circ}\text{C}$

Notes:

- Thermal resistance is referenced to the back of the package.
- IR scan equivalent temperatures. Refer to the following document: [GaN Device Channel Temperature, Thermal Resistance, and Reliability Estimates](#)

Power Dissipation and Maximum Gate Current

$P_{IN} = 18\text{ dBm}$, Pulse Width = 100 us, Duty Cycle = 10%

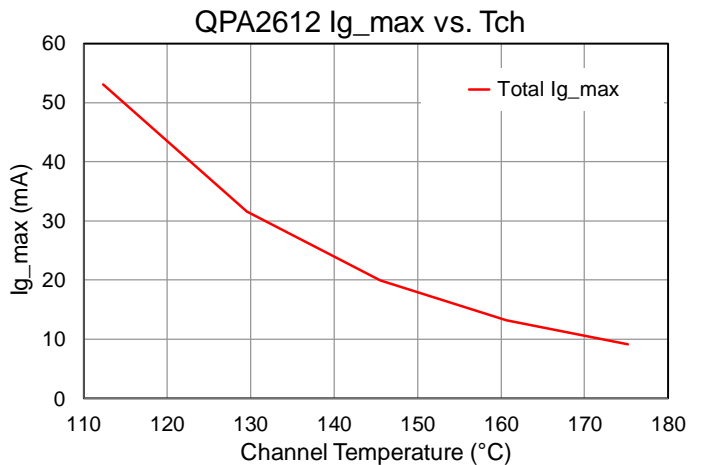
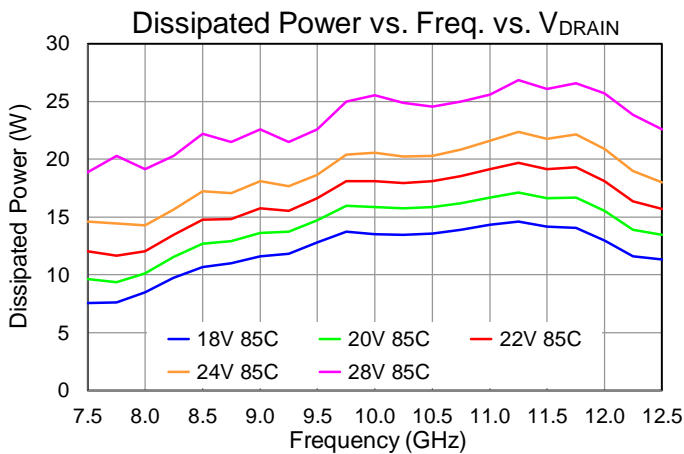

Application Information

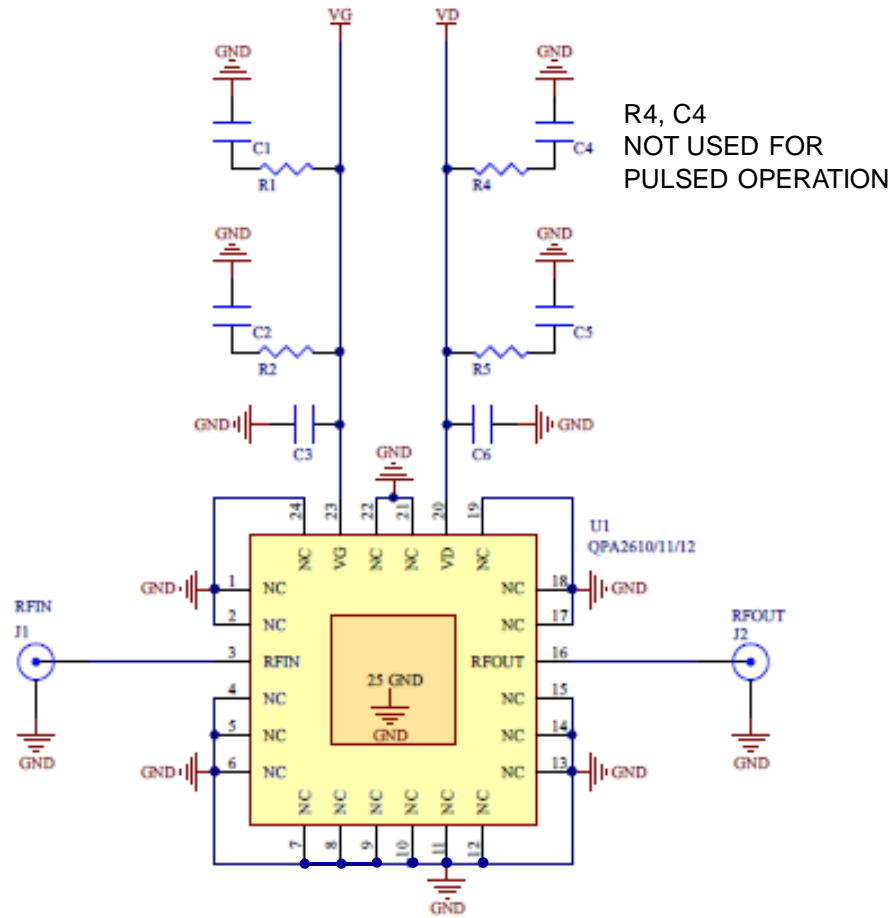

Bias-up Procedure

- Set I_D limit to 1800 mA, I_G limit to 10 mA

- Apply -4 V to V_G

- Apply +24 V to V_D ; ensure I_{DQ} is approx. 0 mA

- Adjust V_G until $I_{DQ} = 250$ mA

- Turn on RF supply

Bias-down Procedure

- Turn off RF signal

- Reduce V_G to -4 V; ensure I_{DQ} is approx. 0 mA

- Set V_D to 0 V

- Turn off V_D supply

- Turn off V_G supply

Pin Layout

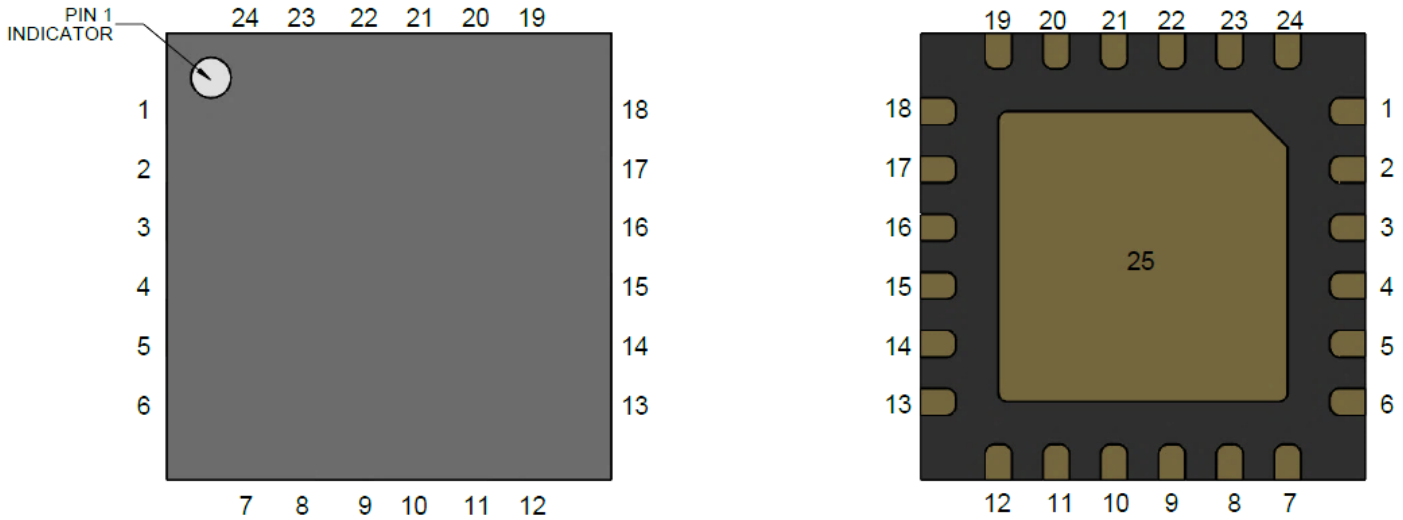

Pin Description

Pin Number	Symbol	Description
1, 2, 4-15, 17-19, 21, 22, 24	NC	No connection inside of package. Connection to PCB ground recommended
3	RF IN	RF input. 50 Ω, DC blocked, pad connected to ground
16	RF OUT	RF output. 50 Ω, DC blocked, pad connected to ground
20	VD	Drain voltage. Bypass network required; refer to page 19
23	VG	Gate voltage. Bypass network required; refer to page 19
25	GND	Center paddle ground

Evaluation Board

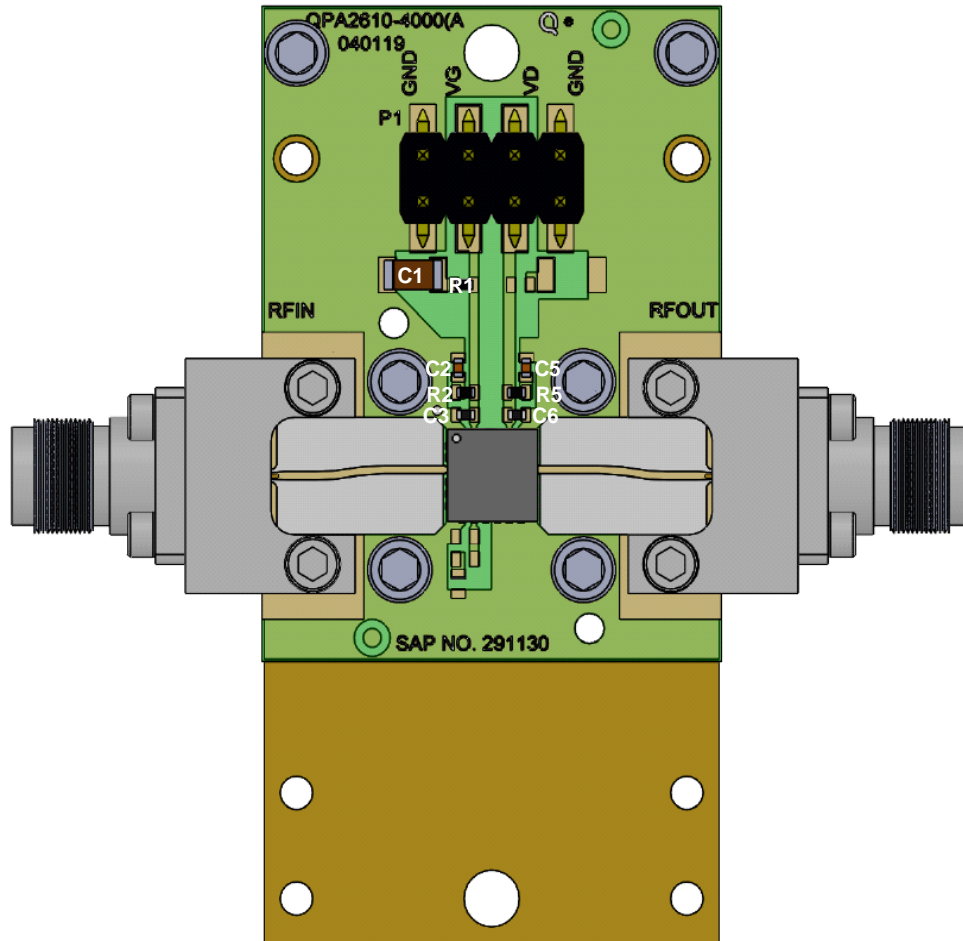

Bill of Materials

Ref. Des.	Value	Description	Manuf.	Part Number
C1	10 uF	CAP, 10uF, 20%, 50V, 20%, X5R, 1206	various	
C3,C6	1000 pF	CAP, 1000pF, 10%, 100V, X7R, 0402	various	
C2,C5	0.1 uF	CAP, 0.1uF, 10%, 50V, X7R, 0402	various	
R2,R5	10 Ω	RES, 10 OHM, 5%, 0.1W, 0402	various	
R1	0 Ω	RES, 0 OHM, JMPR, 0402	various	
J1, J2		2.92mm Female End Launch Connector	Southwest Microwave	1092-01A-5

Mechanical Information

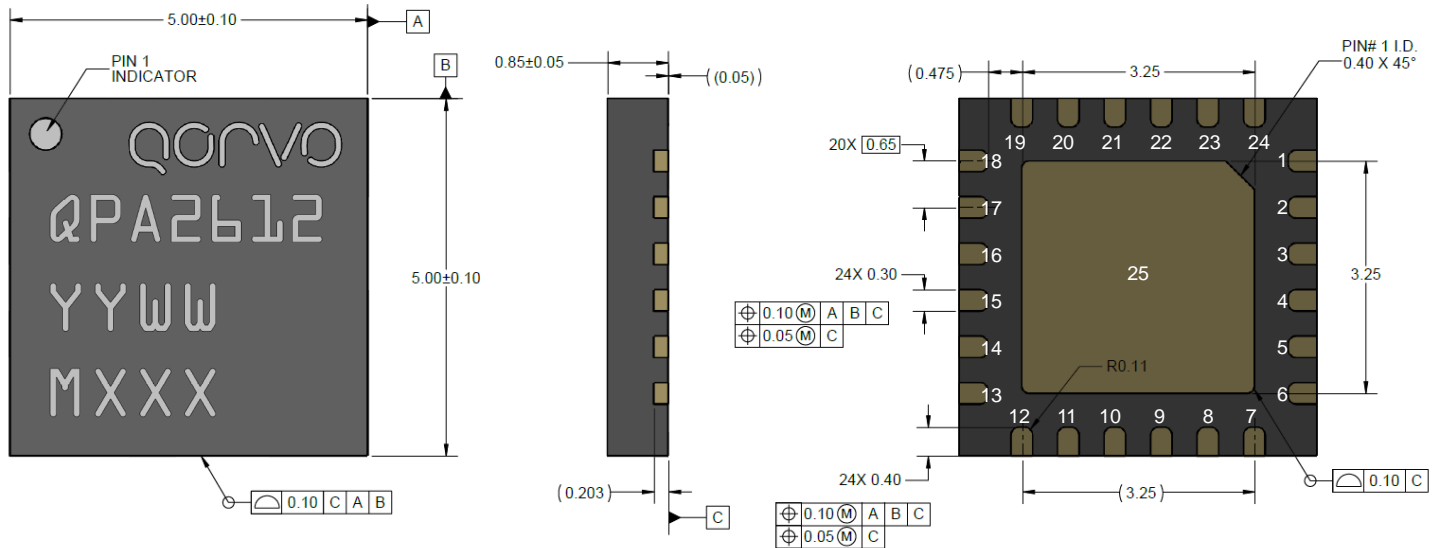

NOTES:

Package base and leads are Ni-Au plated

Part Markings:

- Part Number: QPA2612
- Part Assembly Year: YY
- Part Assembly Week: WW
- Lot Number: MXXX

Dimensions are in millimeters

Assembly Notes

Compatible with lead-free soldering processes with 260°C peak reflow temperature.

Contact plating: Ni-Au.

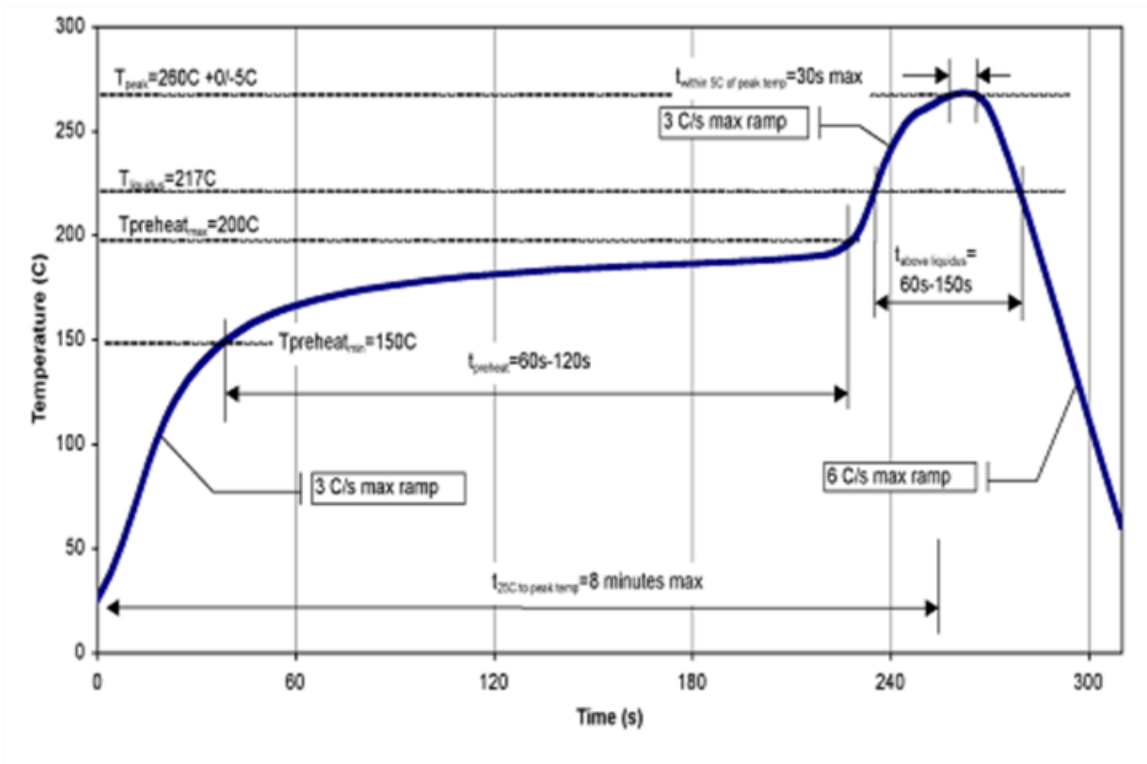

Recommended Soldering Temperature Profile

Tape and Reel Information – Carrier and Cover Tape Dimensions

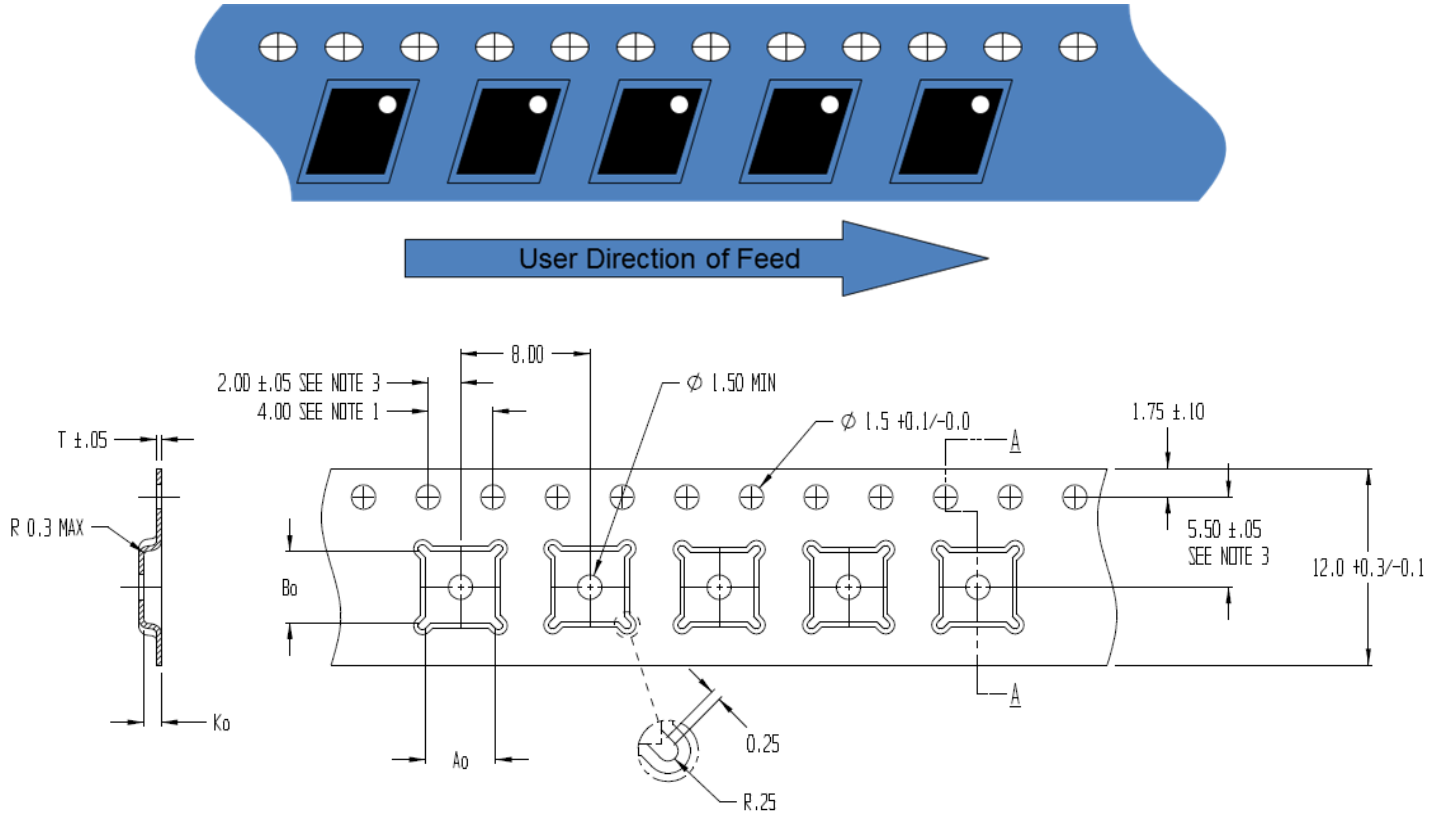

Feature	Measure	Symbol	Size (in)	Size (mm)
Cavity	Length	A0	0.189	4.80
	Width	B0	0.209	5.30
	Depth	K0	0.051	1.30
	Pitch	P1	0.315	8.00
Centerline Distance	Cavity to Perforation - Length Direction	P2	0.079	2.00
	Cavity to Perforation - Width Direction	F	0.217	5.50
Cover Tape	Width	C	0.362	9.20
Carrier Tape	Width	W	0.472	12.00

Tape and Reel Information – Reel Dimensions

Standard T/R size = 500 pieces on a 7" reel.

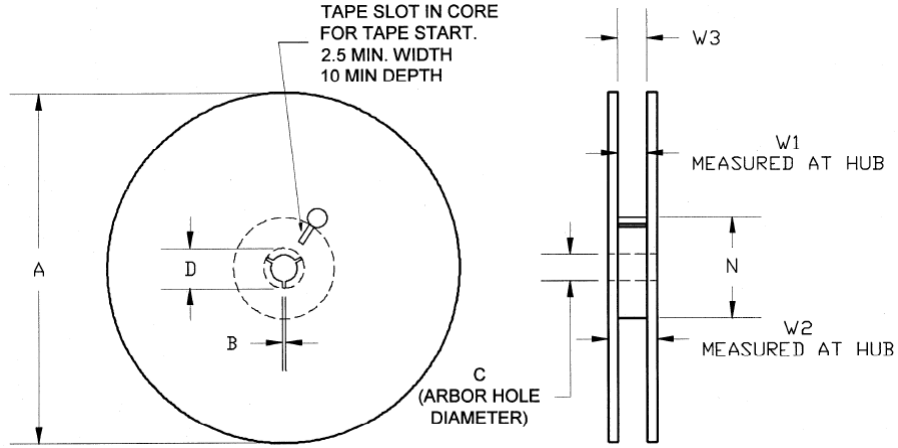

Feature	Measure	Symbol	Size (in)	Size (mm)
Flange	Diameter	A	6.969	177.0
	Thickness	W2	0.717	18.2
	Space Between Flange	W1	0.504	12.8
Hub	Outer Diameter	N	2.283	58.0
	Arbor Hole Diameter	C	0.512	13.0
	Key Slit Width	B	0.079	2.0
	Key Slit Diameter	D	0.787	20.0

Tape and Reel Information – Tape Length and Label Placement

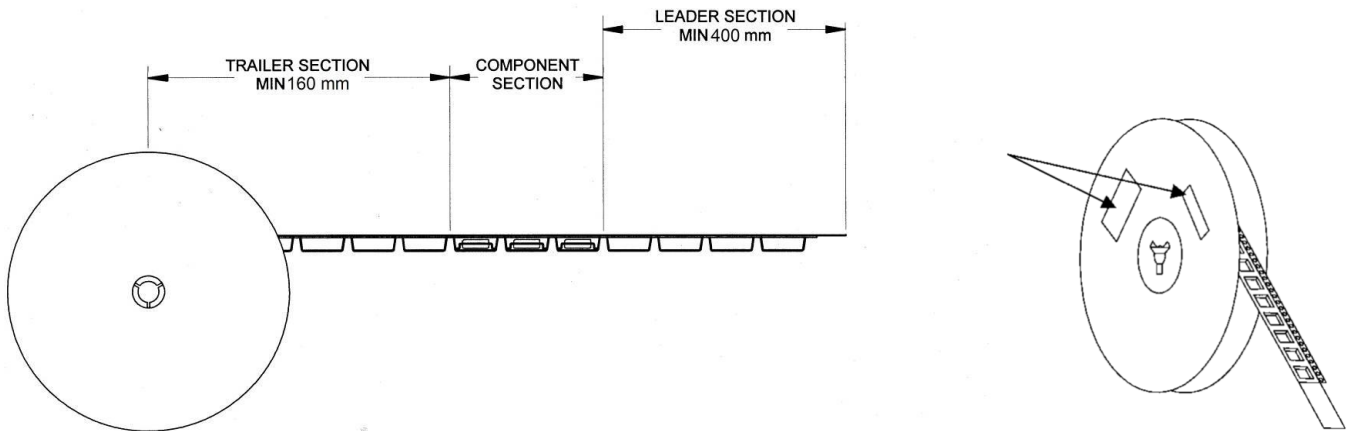

- Notes:
1. Empty part cavities at the trailing and leading ends are sealed with cover tape. See EIA 481-1-A.
 2. Labels are placed on the flange opposite the sprockets in the carrier tape.