

### Product Overview

Qorvo’s QPA3069 is a packaged, high-power S-band amplifier fabricated on Qorvo’s production 0.25 um GaN on SiC process (QGaN25). Covering 2.7–3.5 GHz, the QPA3069 provides 50 dBm of saturated output power and 25 dB of large-signal gain while achieving 53% power-added efficiency.

The QPA3069 is packaged in a 7 mm x 7 mm 48-pin plastic overmolded package. It can support a variety of operating conditions to best support system requirements. With good thermal properties, it can support a range of bias voltages.

The QPA3069 MMIC has DC blocking capacitors on both RF ports, which are matched to 50 ohms. The QPA3069 is ideal for military radar systems.

Lead-free and RoHS compliant.

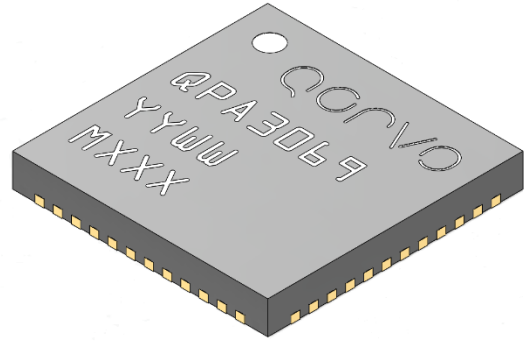

### Key Features

- Frequency Range: 2.7–3.5 GHz
- $P_{SAT}$  ( $P_{IN}=25$  dBm): > 50 dBm
- PAE ( $P_{IN}=25$  dBm): > 53 %
- Power Gain ( $P_{IN}=25$  dBm): > 25 dB
- Bias:  $V_D = 30$  V,  $I_{DQ} = 300$  mA,  $P_{IN} = 25$  dBm
- Package Dimensions: 7.00 x 7.00 x 0.85 mm

*Performance is typical across frequency. Please reference electrical specification table and data plots for more details.*

### Functional Block Diagram

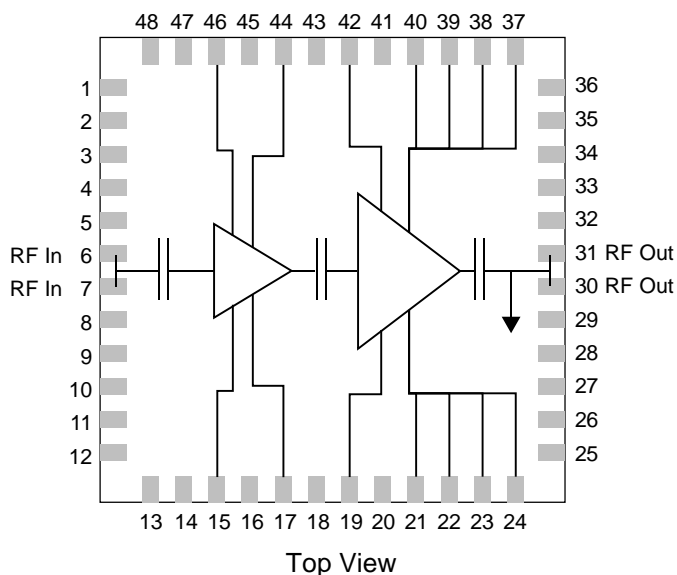

### Applications

- Radar

### Ordering Information

Part No.	Description
QPA3069	2.7 – 3.5 GHz 100 W GaN Power Amplifier (10 Pcs.)
QPA3069TR7	250 piece 7" reel
QPA3069EVB	Evaluation Board for QPA3069

## Absolute Maximum Ratings

Parameter	Value / Rang
Drain Voltage ( $V_D$ )	40 V
Gate Voltage Range ( $V_G$ )	-8 to +1 V
Drain Current ( $I_D$ )	13.6 A
Gate Current ( $I_G$ )	See plot on page 12
Power Dissipation ( $P_{DISS}$ ), 85 °C	117 W
Input Power ( $P_{IN}$ ), Pulsed, 50 $\Omega$ , $V_D=28$ V, $I_{DQ}=300$ mA, 85 °C	31 dBm
Input Power ( $P_{IN}$ ), Pulsed, 3:1 VSWR, $V_D=28$ V, $I_{DQ}=300$ mA, 85 °C	28 dBm
Soldering Temperature (30 seconds)	260 °C
Storage Temperature	-55 to 150 °C

Operation of this device outside the parameter ranges given above may cause permanent damage. These are stress ratings only, and functional operation of the device at these conditions is not implied.

## Recommended Operating Conditions

Parameter	Value / Range
Drain Voltage ( $V_D$ )	30 V
Drain Current ( $I_{DQ}$ )	300 mA
Gate Voltage Range ( $V_G$ )	-2.8 to -2.0 V
Operating Temperature	-40 to +85 °C

Electrical specifications are measured at specified test conditions. Specifications are not guaranteed over all recommended operating conditions.

## Electrical Specifications

Parameter		Min	Typ	Max	Units
Operational Frequency Range		2.7		3.5	GHz
Output Power ( $P_{IN} = 25$ dBm)	2.7 GHz		50.4		dBm
	3.1 GHz		50.5		dBm
	3.5 GHz		50.1		dBm
Power Added Efficiency ( $P_{IN} = 25$ dBm)	2.7 GHz		54.3		%
	3.1 GHz		55.9		%
	3.5 GHz		55.8		%
Small Signal Gain (CW)	2.7 GHz		31.1		dB
	3.1 GHz		31.7		dB
	3.5 GHz		29.3		dB
Input Return Loss (CW)	2.7 GHz		13		dB
	3.1 GHz		10		dB
	3.5 GHz		29		dB
Output Return Loss (CW)	2.7 GHz		7		dB
	3.1 GHz		5		dB
	3.5 GHz		19		dB
Second Harmonic ( $P_{IN} = 25$ dBm)			-23		dBc
Third Harmonic ( $P_{IN} = 25$ dBm)			-40		dBc
Gate Leakage ( $V_D = 10$ V, $V_G = -3.7$ V)		-42.0	-4.5	-0.0001	mA
$P_{OUT}$ Temp. Coeff. (85–25 °C, $P_{IN} = 25$ dBm))			0.001		dB/°C
Sm. Sig. Gain Temp. Coefficient (85 to -40 °C, CW)			-0.041		dB/°C

Test conditions, unless otherwise noted:  $T = 25$  °C,  $V_D = 30$  V,  $I_{DQ} = 300$  mA,  $PW = 100$  us, Duty Cycle = 10%

Performance Plots – Large Signal

Test conditions unless otherwise noted:  $V_D = 30\text{ V}$ ,  $I_{DQ} = 300\text{ mA}$ ,  $P_{IN} = 25\text{ dBm}$ ,  $PW = 100\text{ us}$ , Duty Cycle = 10%

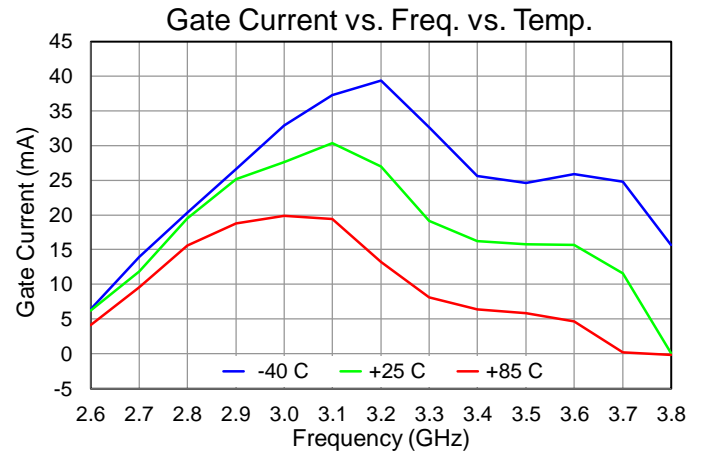
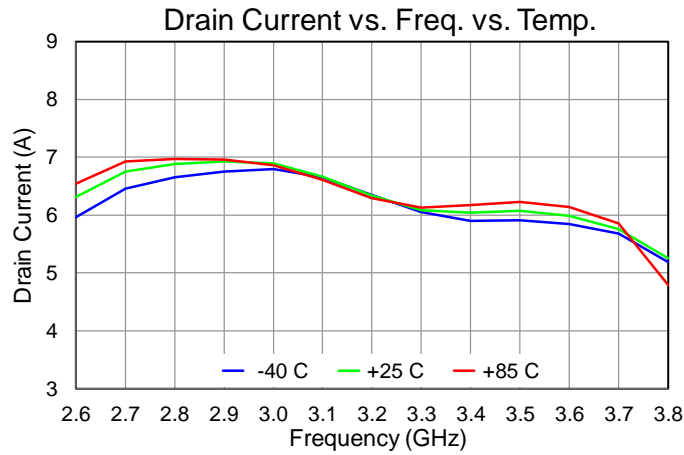
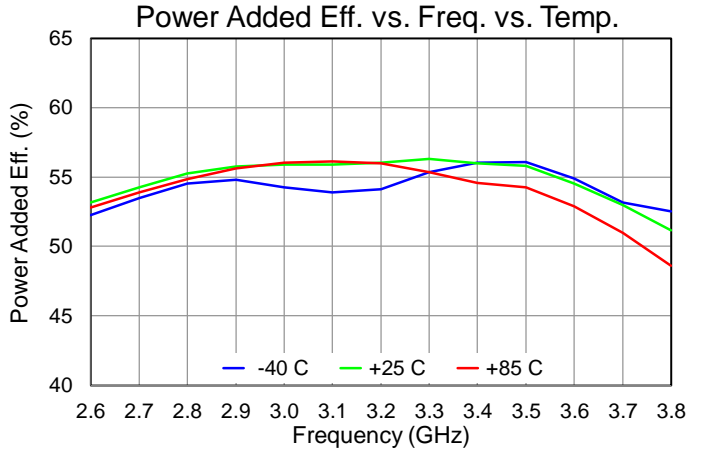
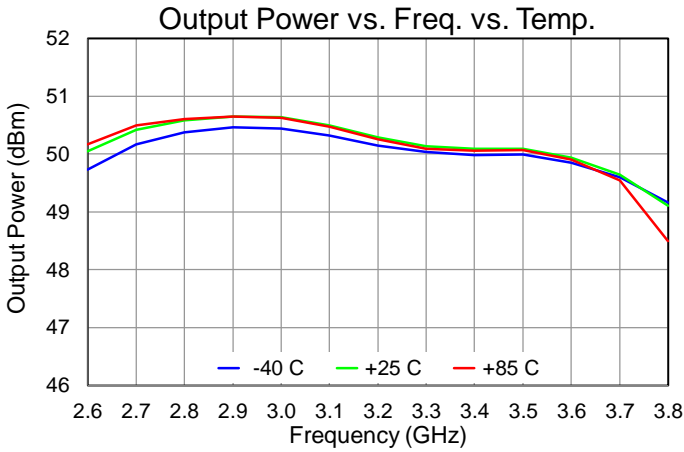

Performance Plots – Large Signal

Test conditions unless otherwise noted:  $I_{DQ} = 300 \text{ mA}$ ,  $T = +25 \text{ }^\circ\text{C}$ ,  $P_{IN} = 25 \text{ dBm}$ ,  $PW = 100 \text{ } \mu\text{s}$ , Duty Cycle = 10%

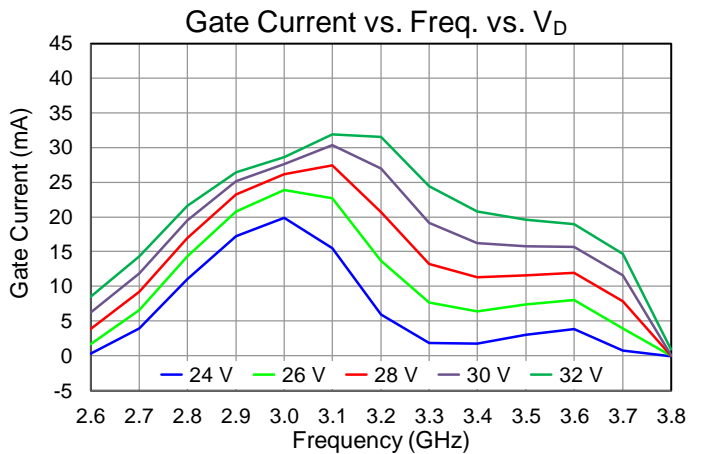
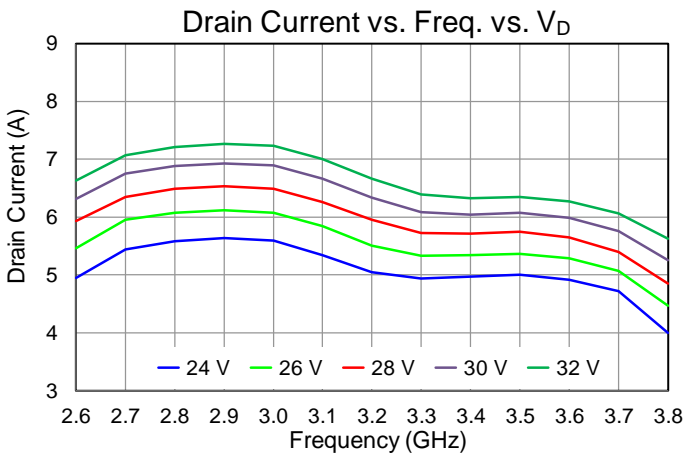
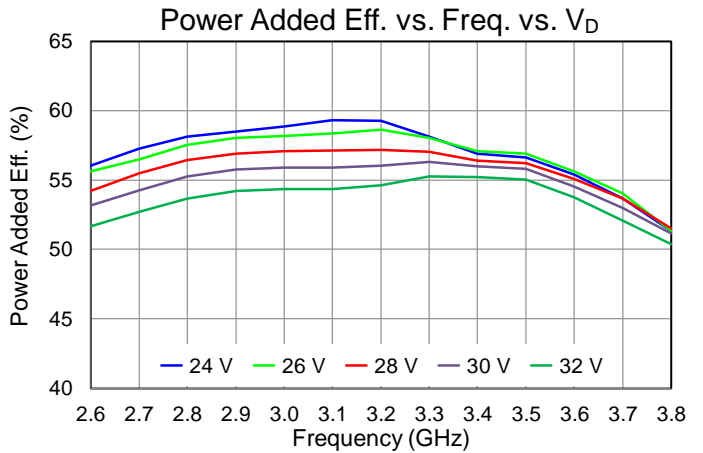
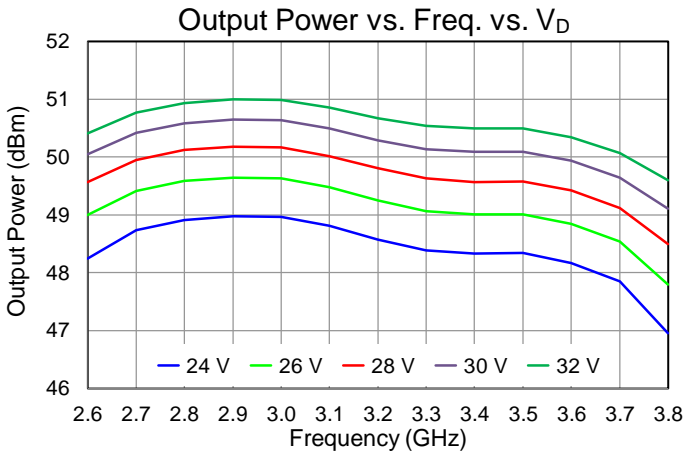

Performance Plots – Large Signal

Test conditions unless otherwise noted:  $V_D = 30\text{ V}$ ,  $I_{DQ} = 300\text{ mA}$ ,  $T = +25\text{ }^\circ\text{C}$ ,  $PW = 100\text{ }\mu\text{s}$ , Duty Cycle = 10%

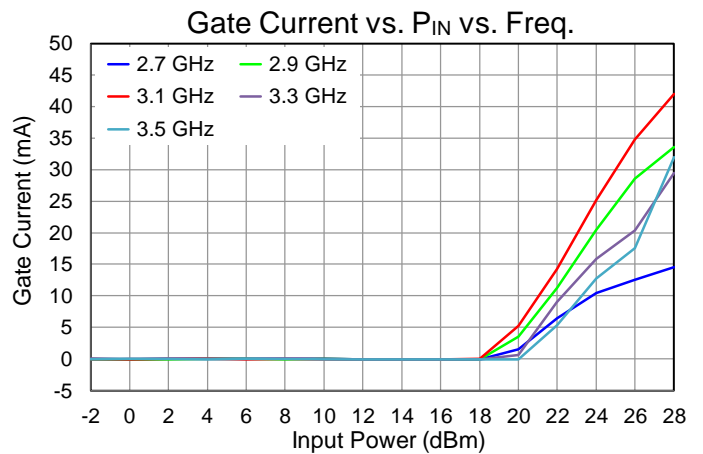
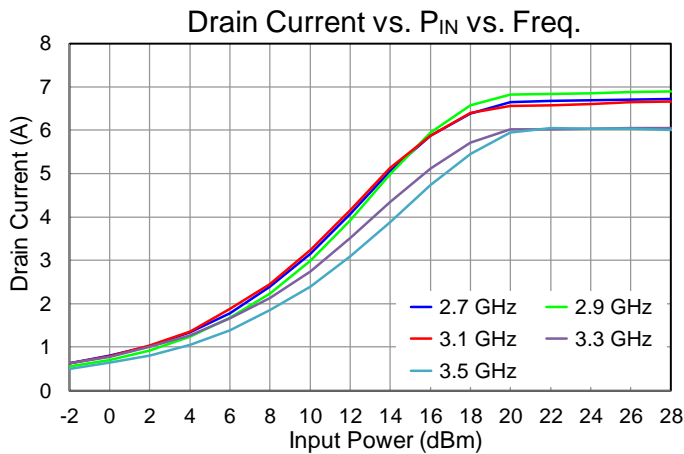
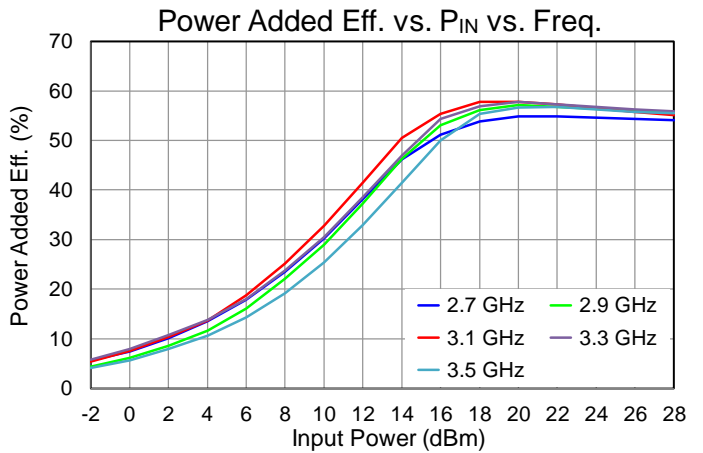
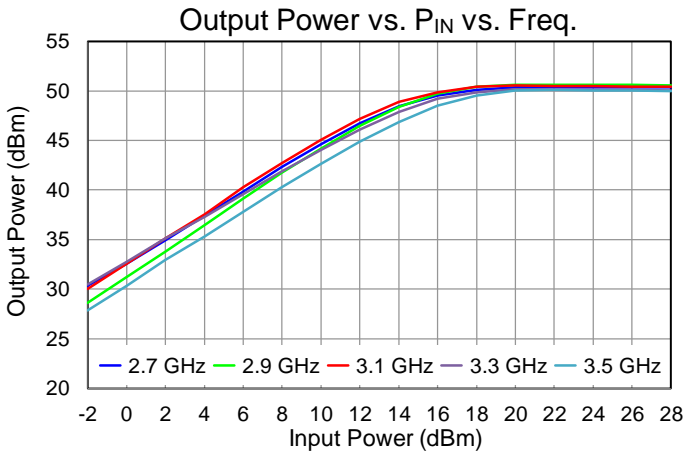

Performance Plots – Large Signal

Test conditions unless otherwise noted:  $V_D = 30\text{ V}$ ,  $I_{DQ} = 300\text{ mA}$ ,  $PW = 100\text{ us}$ , Duty Cycle = 10%

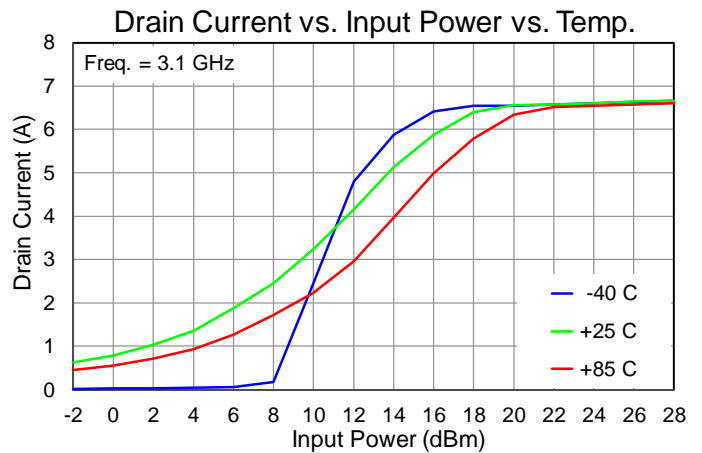
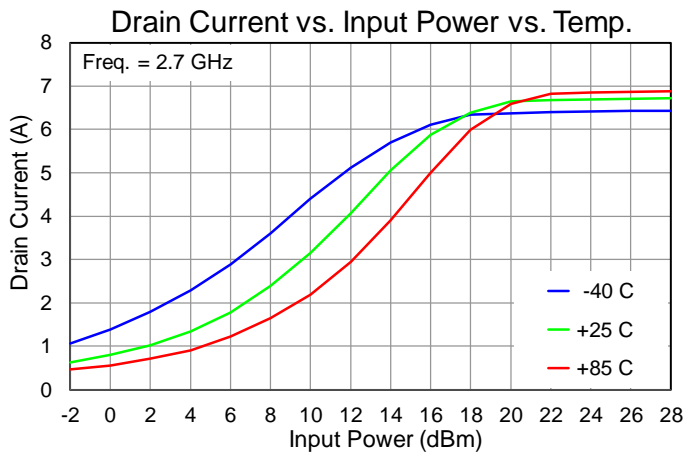
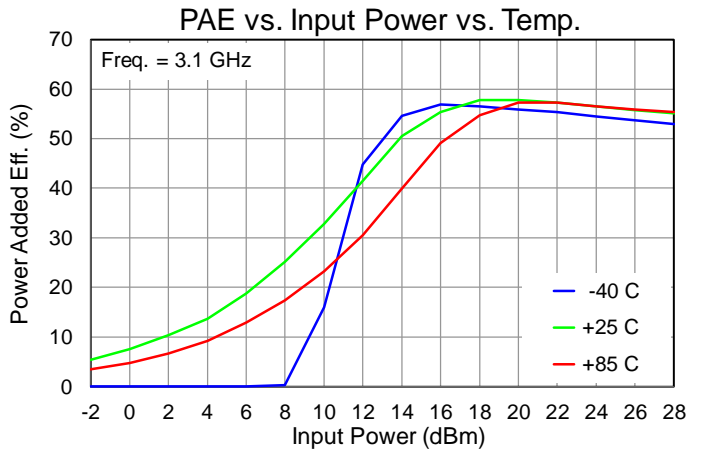
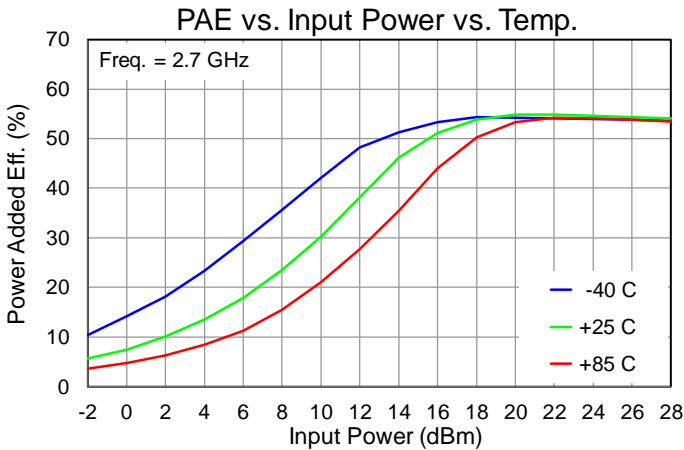
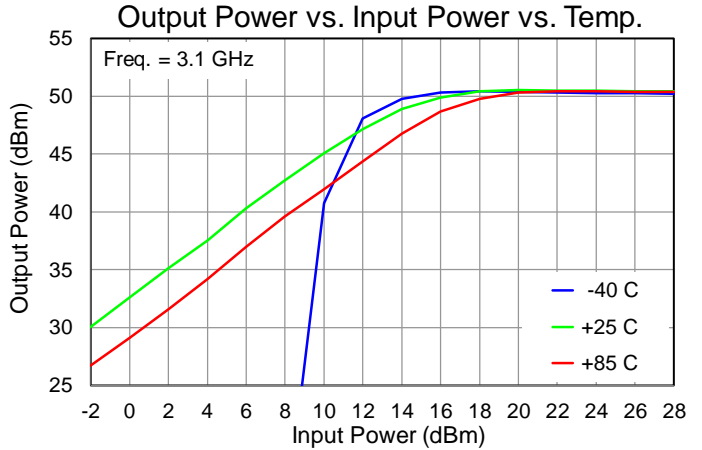
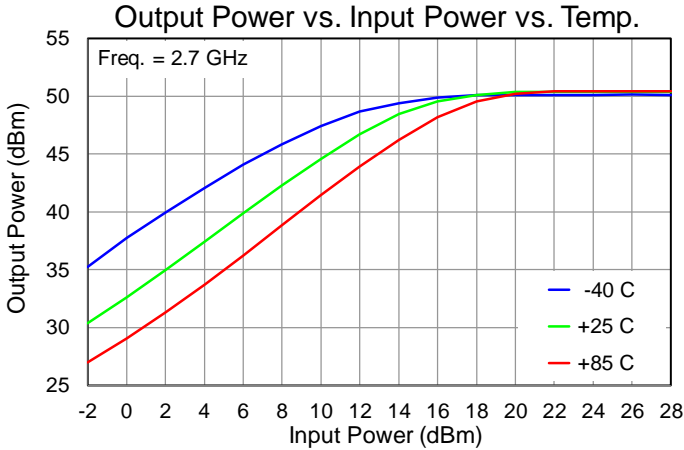

**Performance Plots – Large Signal**

Test conditions unless otherwise noted:  $V_D = 30\text{ V}$ ,  $I_{DQ} = 300\text{ mA}$ ,  $PW = 100\text{ us}$ , Duty Cycle = 10%

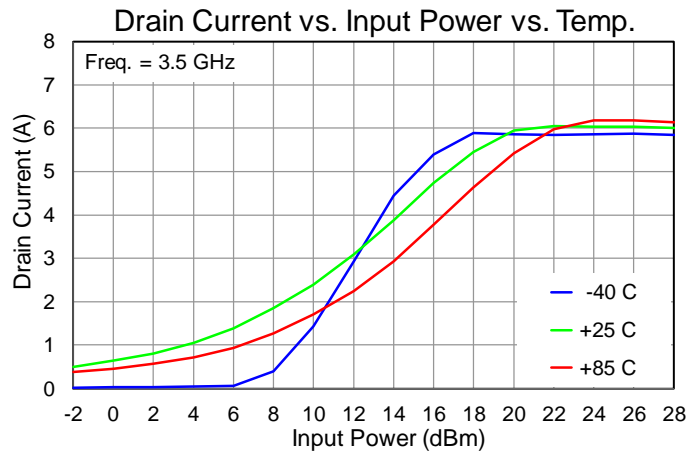
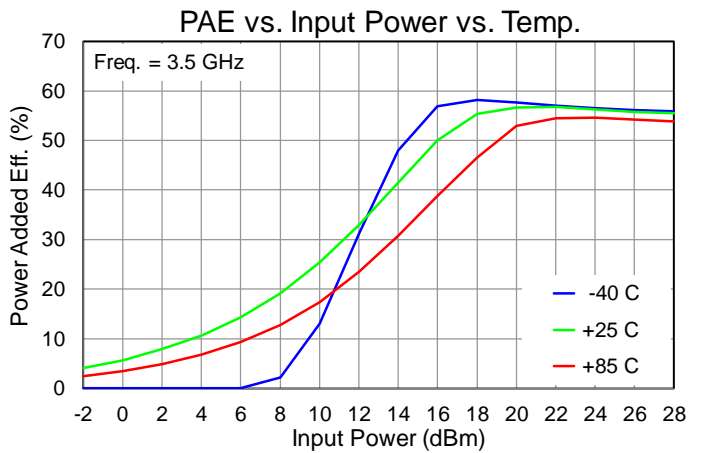
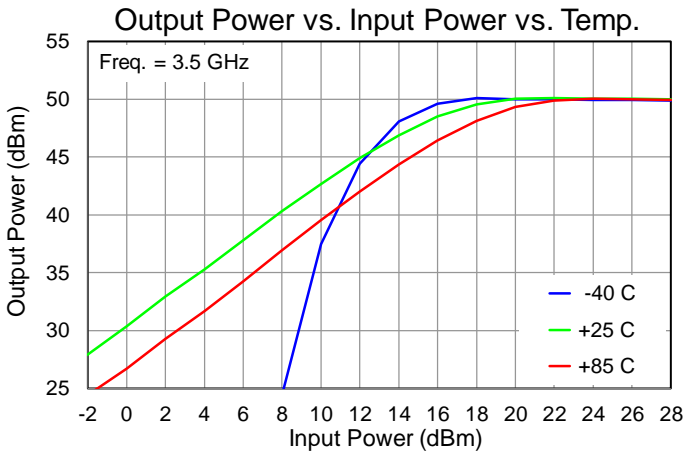

**Performance Plots – Large Signal**

Test conditions unless otherwise noted:  $I_{DQ} = 300\text{ mA}$ ,  $PW = 100\text{ }\mu\text{s}$ , Duty Cycle = 10%

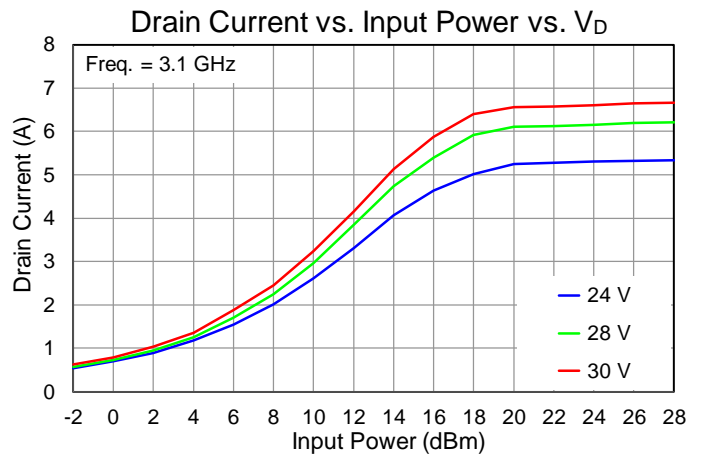
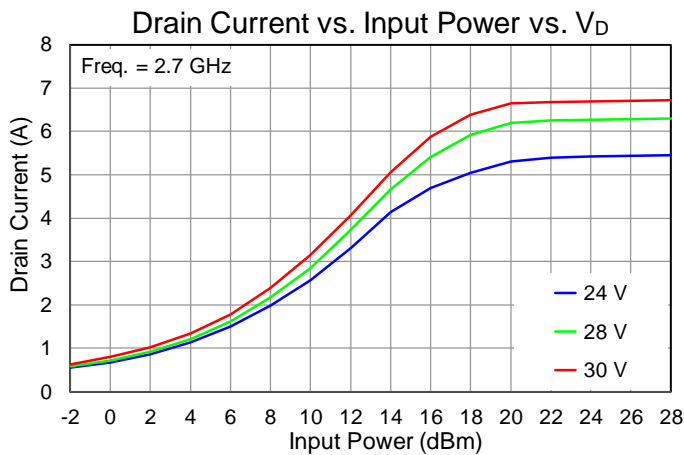
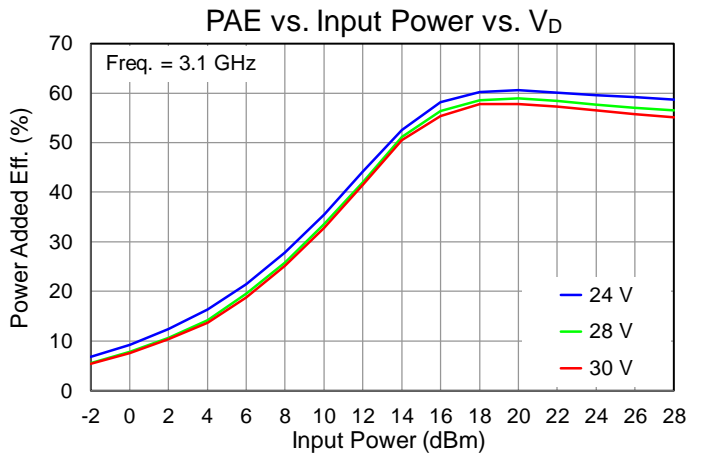
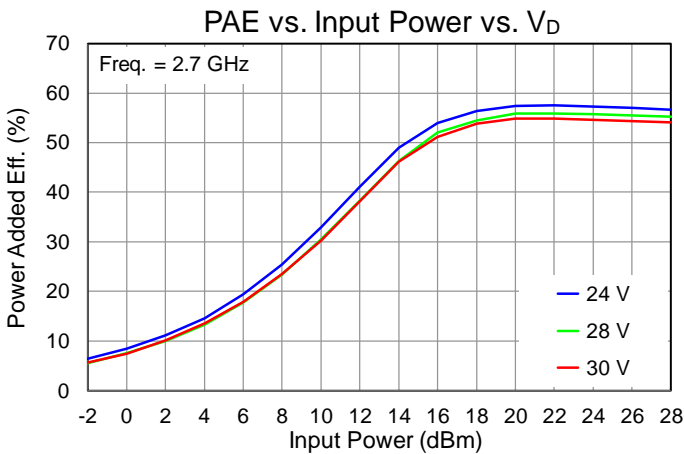
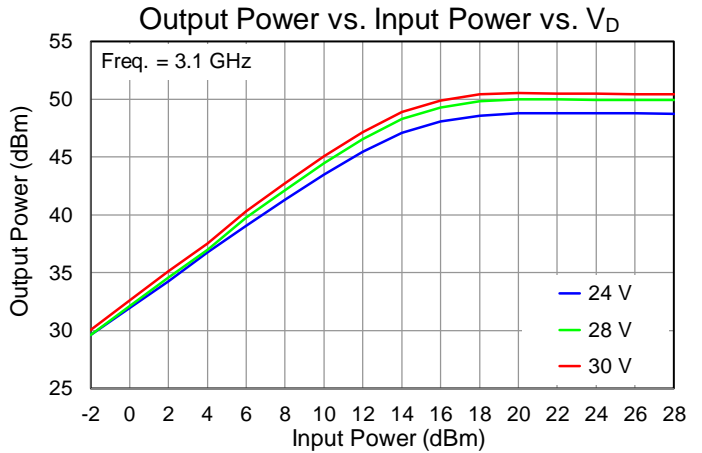
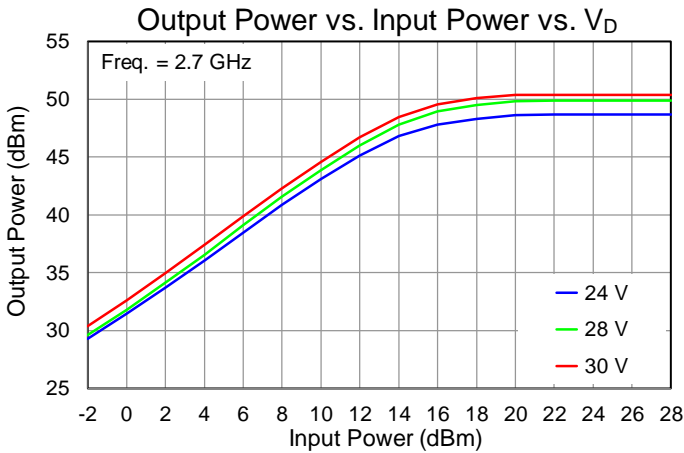



**Performance Plots – Large Signal**

Test conditions unless otherwise noted:  $I_{DQ} = 300 \text{ mA}$ ,  $T = +25 \text{ }^\circ\text{C}$ ,  $PW = 100 \text{ } \mu\text{s}$ , Duty Cycle = 10%

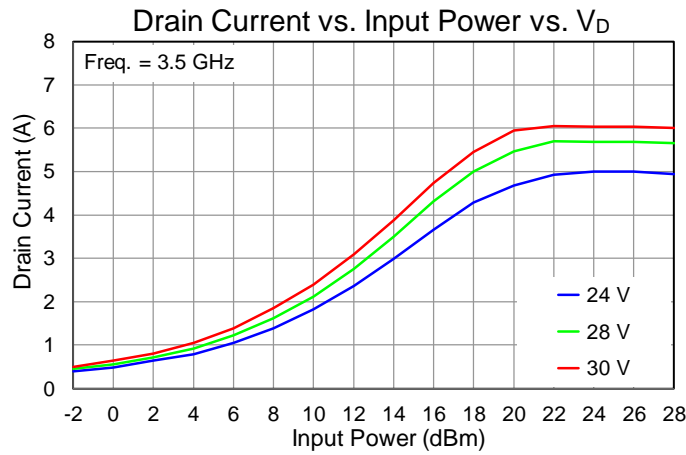
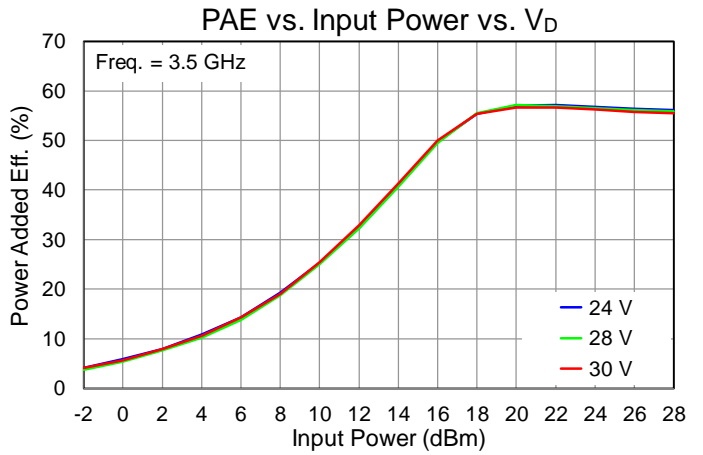
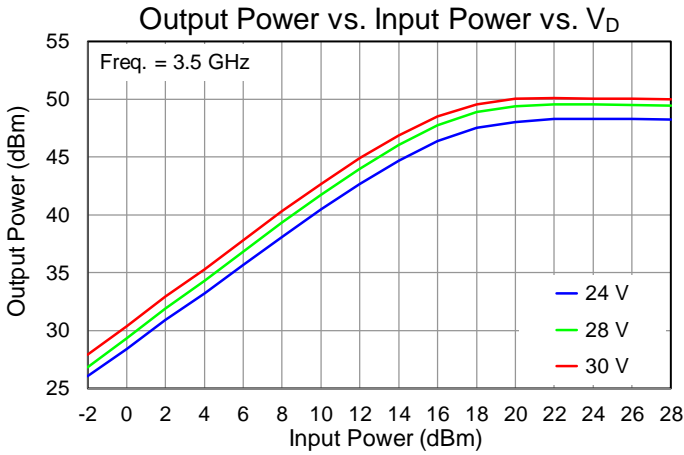

Performance Plots – Harmonics

Test conditions unless otherwise noted:  $V_D = 30\text{ V}$ ,  $I_{DQ} = 300\text{ mA}$ ,  $T = +25\text{ }^\circ\text{C}$ ,  $PW = 100\text{ }\mu\text{s}$ , Duty Cycle = 10%

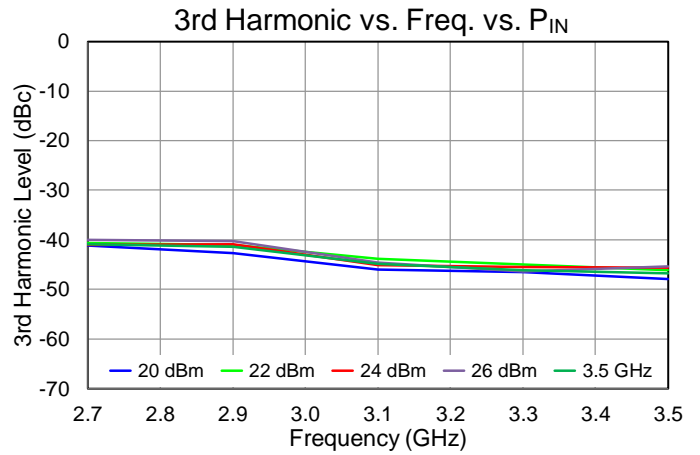
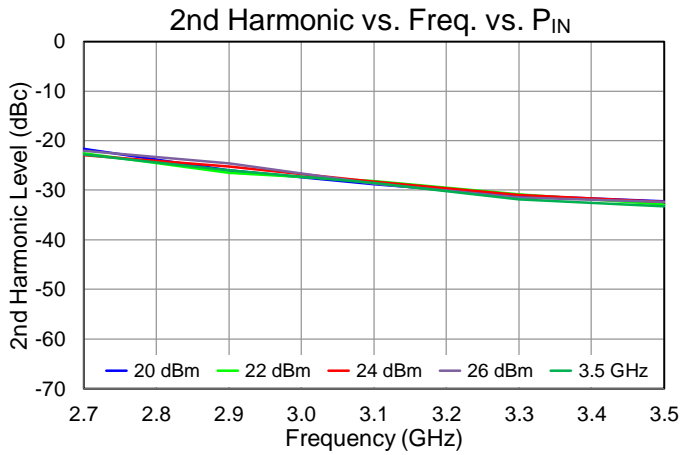
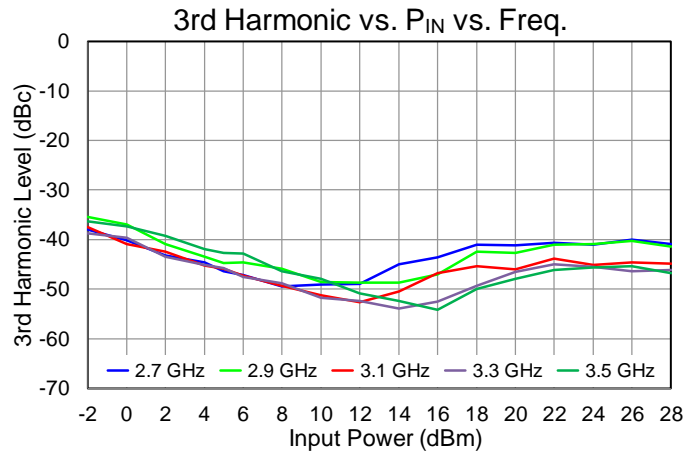
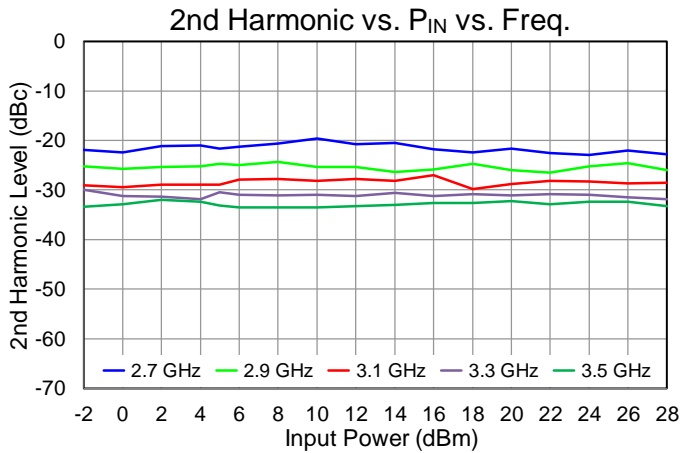

**Performance Plots – Small Signal**

Test conditions unless otherwise noted:  $V_D = 30\text{ V}$ ,  $I_{DQ} = 300\text{ mA}$ ,  $T = +25\text{ }^\circ\text{C}$

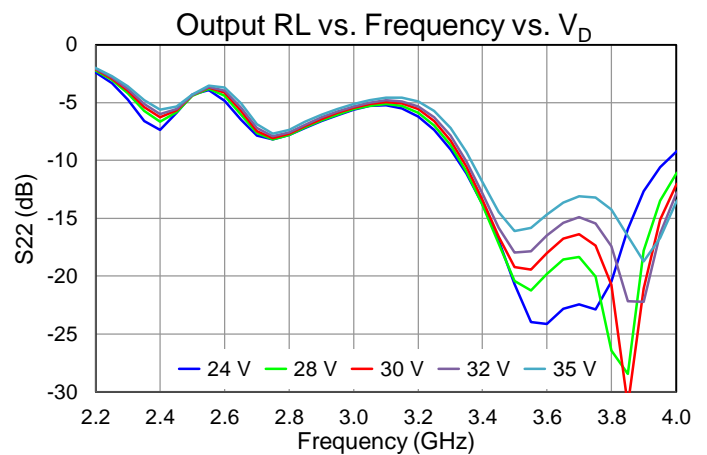
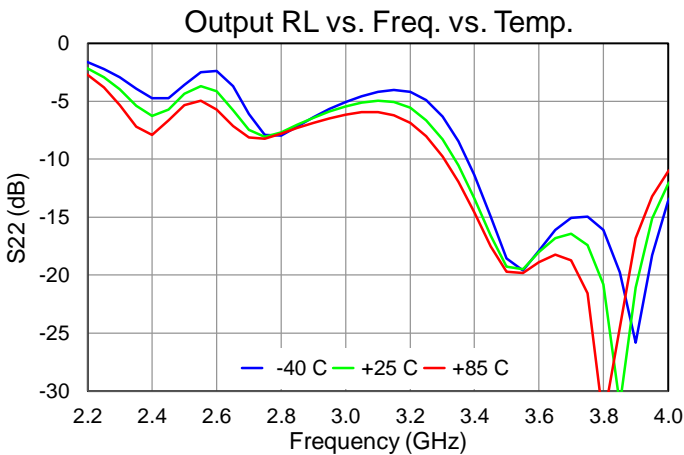
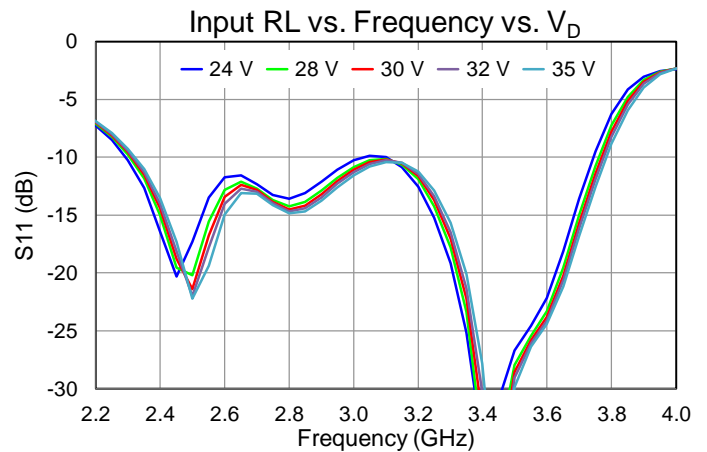
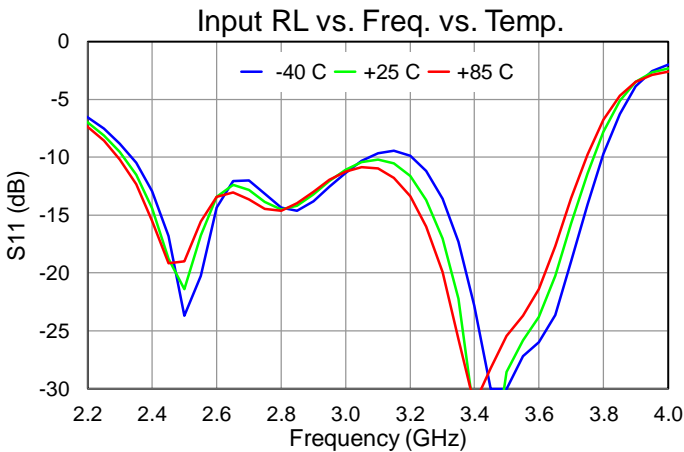
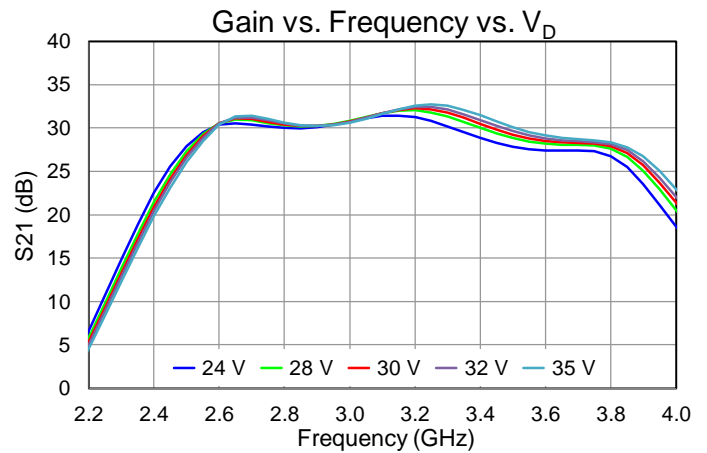
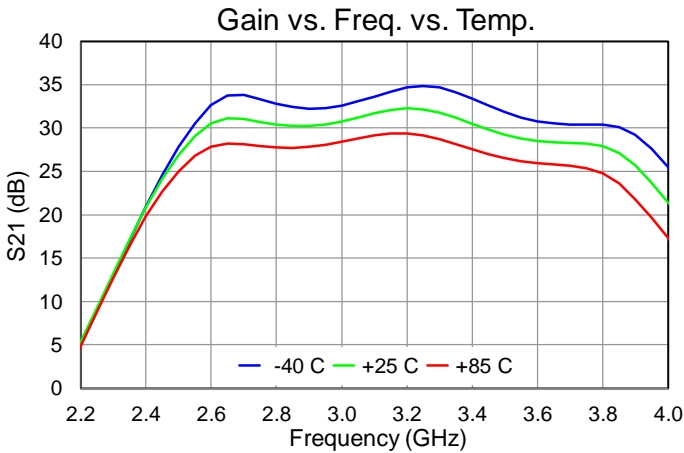

## Thermal and Reliability Information

Parameter	Test Conditions	Value	Units
Thermal Resistance ( $\theta_{JC}$ ) <sup>(1)</sup>	$T_{base} = 85\text{ }^{\circ}\text{C}$ , $V_D = 30\text{ V}$ , $I_{DQ} = 300\text{ mA}$ , $P_{DISS} = 9.0\text{ W}$	0.511	$^{\circ}\text{C}/\text{W}$
Channel Temperature, $T_{CH}$ (No RF drive) <sup>(2)</sup>		89.6	$^{\circ}\text{C}$
Thermal Resistance ( $\theta_{JC}$ ) <sup>(1)</sup>	$T_{base} = 85\text{ }^{\circ}\text{C}$ , $V_D = 30\text{ V}$ , $I_{DQ} = 300\text{ mA}$ , Freq = 2.7 GHz, $I_{D\_Drive} = 6.93\text{ A}$ , $P_{IN} = 25\text{ dBm}$ , $P_{OUT} = 50.5\text{ dBm}$ , $P_{DISS} = 95.7\text{ W}$ , $PW = 100\text{ }\mu\text{s}$ , DC = 10%	0.373	$^{\circ}\text{C}/\text{W}$
Channel Temperature, $T_{CH}$ (w/RF drive) <sup>(2)</sup>		120.7	$^{\circ}\text{C}$
Thermal Resistance ( $\theta_{JC}$ ) <sup>(1)</sup>	$T_{base} = 85\text{ }^{\circ}\text{C}$ , $V_D = 32\text{ V}$ , $I_{DQ} = 300\text{ mA}$ , Freq = 2.7 GHz, $I_{D\_Drive} = 7.33\text{ A}$ , $P_{IN} = 25\text{ dBm}$ , $P_{OUT} = 50.9\text{ dBm}$ , $P_{DISS} = 110.0\text{ W}$ , $PW = 100\text{ }\mu\text{s}$ , DC = 10%	0.391	$^{\circ}\text{C}/\text{W}$
Channel Temperature, $T_{CH}$ (w/RF drive) <sup>(2)</sup>		128.0	$^{\circ}\text{C}$

**Notes:**

1. Thermal resistance determined to the back of the package (fixed at 85  $^{\circ}\text{C}$ )
2. IR scan equivalent. Refer to the following document: [GaN Device Channel Temperature, Thermal Resistance, and Reliability Estimates](#)

## Dissipated Power and Maximum Gate Current

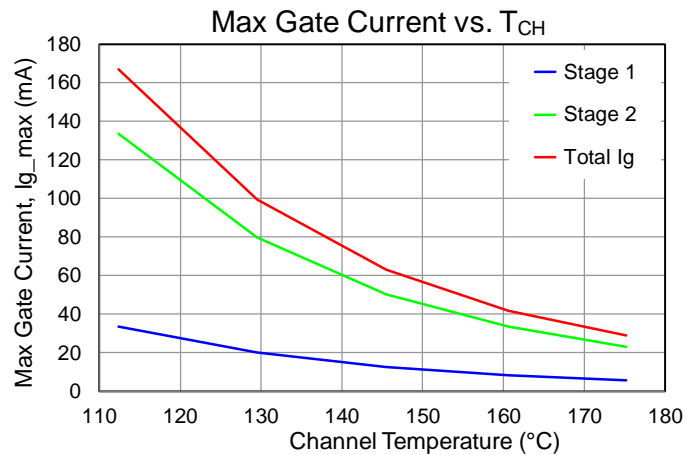
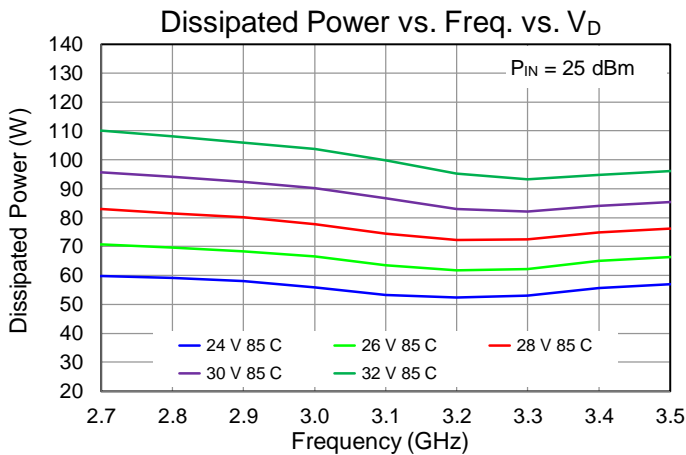

## Applications Information

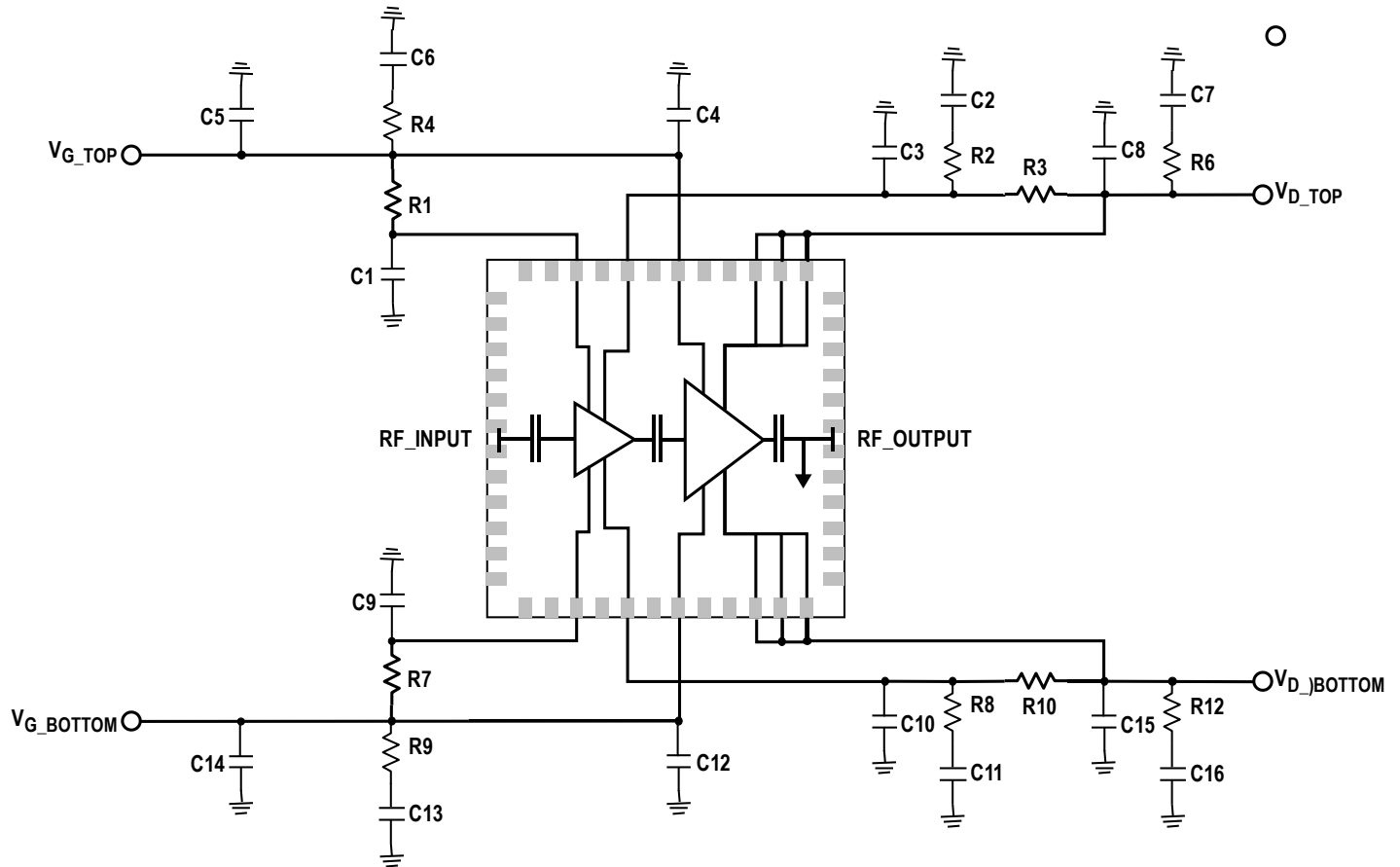

**Notes:**

1.  $V_G$  &  $V_D$  must be biased from both sides.

## Bill of Materials

Reference Des.	Value	Description	Manuf.	Part Number
C1,C3,C4,C8,C9,C10,C12,C15	1000 pF	CAP, 1000pF, 10%, 100V, X7R, 0402	Various	
C2,C6,C11,C13	0.01 uF	CAP, 0.01uF, ±10%, 50V, X7R, 0402	Various	
C5,C14	10 uF	CAP, 10uF, 20%, 50V, 20%, X5R, 1206	Various	
C7,C16	0.1 uF	CAP, 0.1uF, 10%, 50V, X7R, 0402	Various	
R1,R5,R7,R11	10 Ohm	RES, 10 OHM, 5%, 1/10W, 0603	Various	
R2,R4,R6,R8,R9,R12	10 Ohm	RES, 10 OHM, 5%, 0.1W, 0402	Various	
R3,R10	0 Ohm	RES, 0 OHM, 1/10W, 0603	Various	
J1, J2	2.92 mm	Female End Launch Connector	Southwest Microwave	1092-02A-5

Evaluation Board (EVB) Layout Assembly

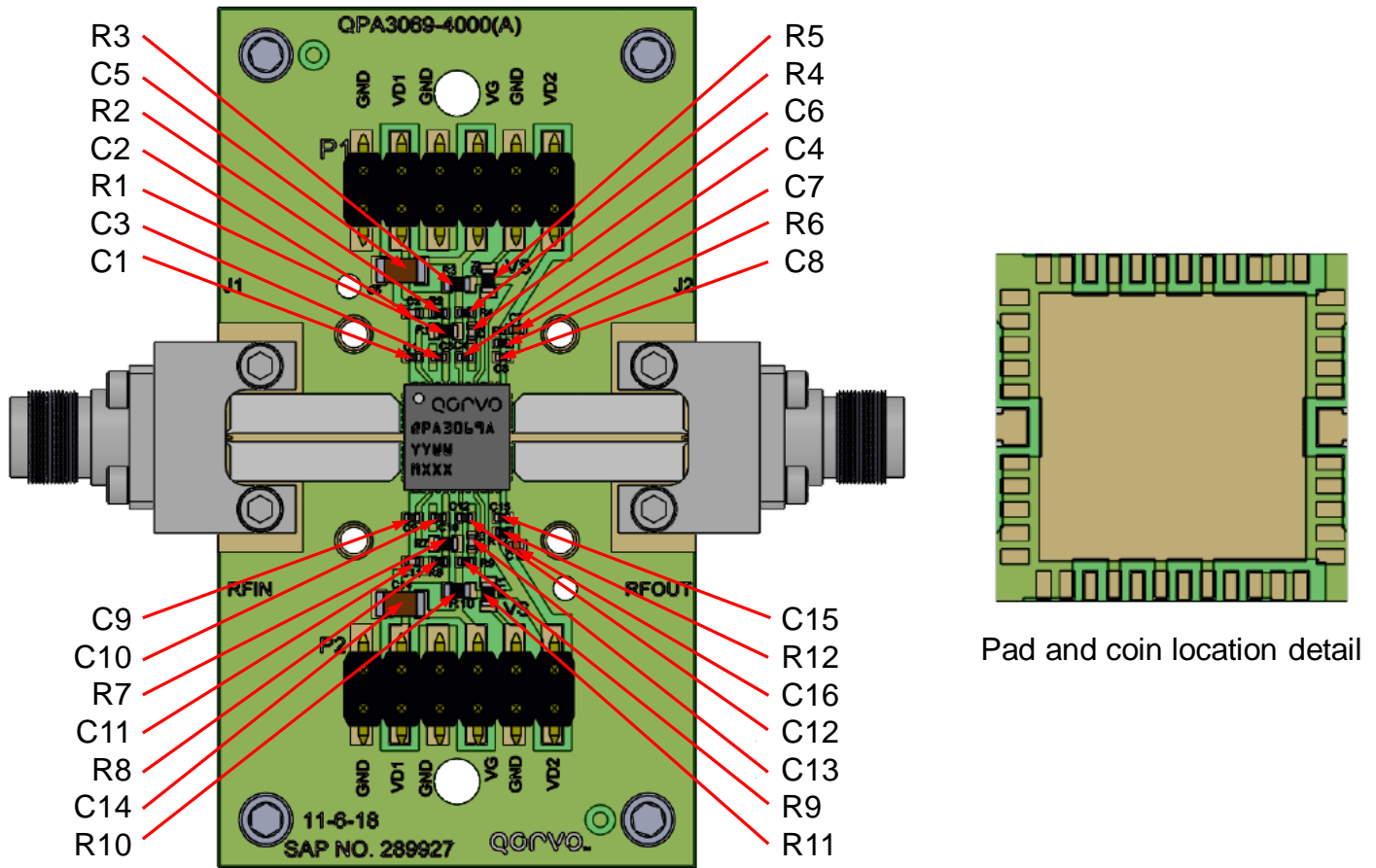

RF PCB is Rogers 6035HTC, 0.010" thick, 0.5 ounce copper both sides  
 Overall PCB is a multi-layer board with a coined center pad for improved thermal conductivity

**Bias-Up Procedure**

1. Set  $I_D$  (peak) limit to 7000 mA,  $I_G$  limit to 60 mA
2. Set  $V_G$  to  $-5.0$  V
3. Set  $V_D$  +30 V
4. Adjust  $V_G$  more positive until  $I_{DQ} \approx 300$  mA, peak
5. Apply RF signal

**Bias-Down Procedure**

1. Turn off RF signal
2. Reduce  $V_G$  to  $-5.0$  V. Ensure  $I_{DQ} \sim 0$  mA
4. Set  $V_D$  to 0 V
5. Turn off  $V_D$  supply
6. Turn off  $V_G$  supply

## Mechanical Information and Bond Pad Description

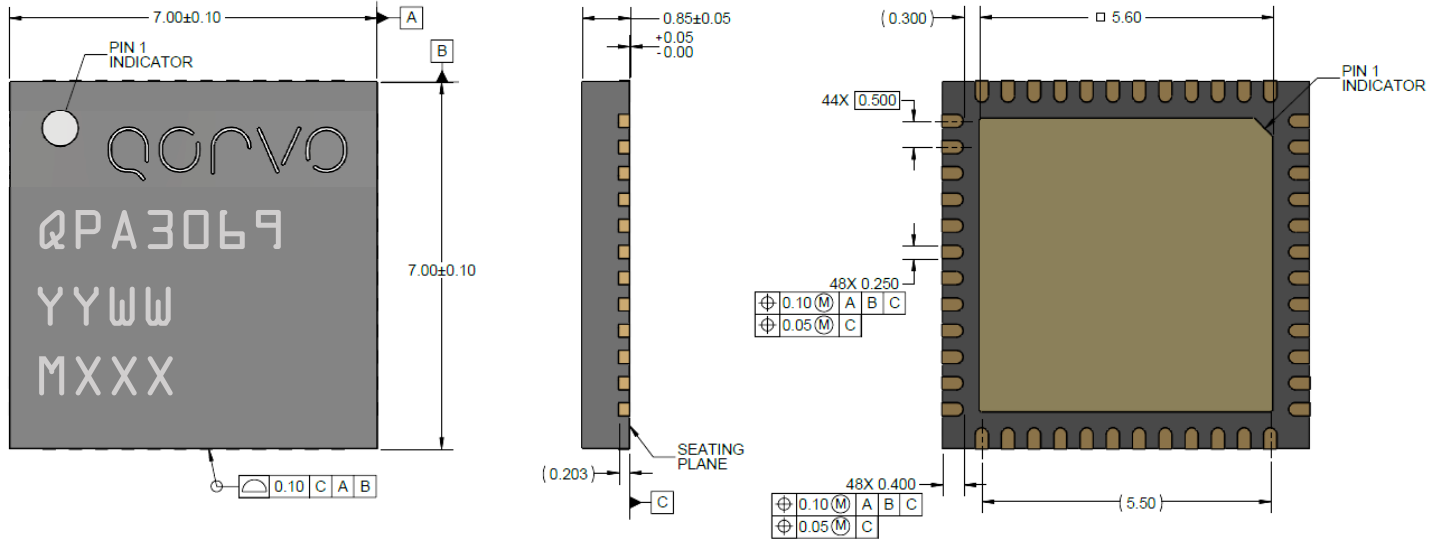

Unless otherwise specified, all dimensions are in mm.

Package leads are gold plated.

Part is mold encapsulated.

Tolerances:

.XX = ± 0.25

.XXX = ± 0.100

.XXXX = ± 0.0254

## Bond Pad Description

Pad No.	Symbol	Description
1-5, 8-14, 16, 18, 20, 25-29, 32-36, 41, 43, 45, 47, 48	NC	No connection. Grounding these pins is recommended, but not required
6, 7	RF INPUT	RF Input; matched to 50 Ω; DC blocked
15, 46	VG1	Gate voltage, stage 1. Bias network is required; see Application Circuit as an example
17, 44	VD1	Drain voltage, stage 1. Bias network is required; see Application Circuit as an example
19, 42	VG2	Gate voltage, stage 2. Bias network is required; see Application Circuit as an example
21, 40	VD2_SENSE	Power supply monitor line for VD2 (do not apply bias to these pads)
22-24, 37-39	VD2	Drain voltage, stage 2. Bias network is required; see Application Circuit as an example
30, 31	RF OUTPUT	RF Output; matched to 50 Ω; DC blocked; DC grounded
Center Pad	GND	Center pad must be grounded to PCB

Recommended Soldering Temperature Profile

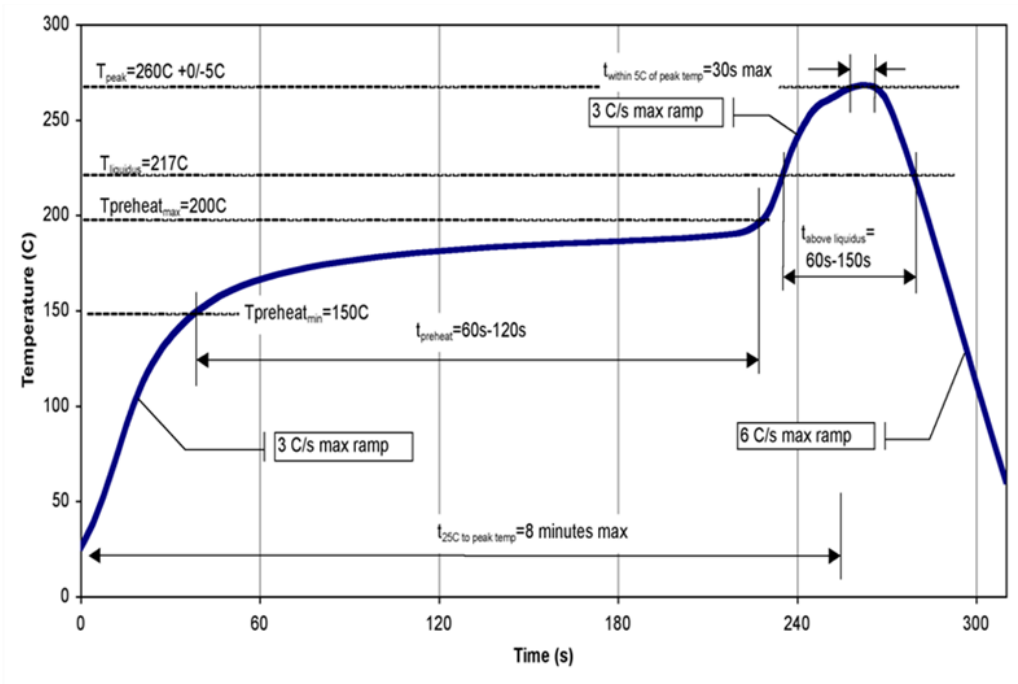



**Tape and Reel Information – Carrier and Cover Tape Dimensions**

Tape and reel specifications for this part are also available on the Qorvo website.  
 Standard T/R size = 250 pieces on a 7" reel.

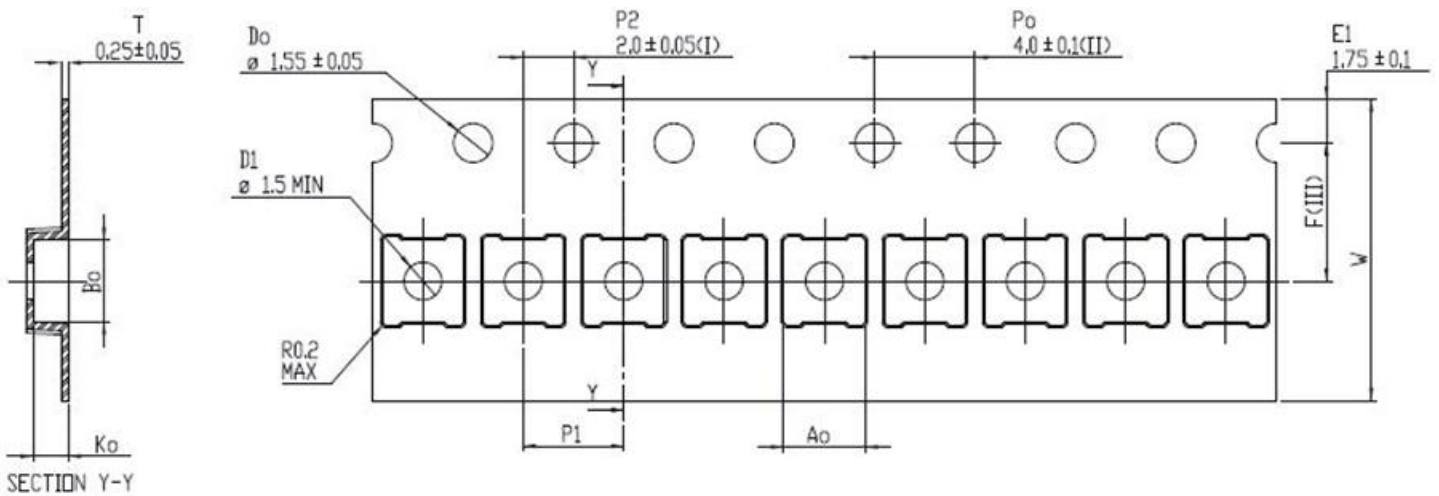
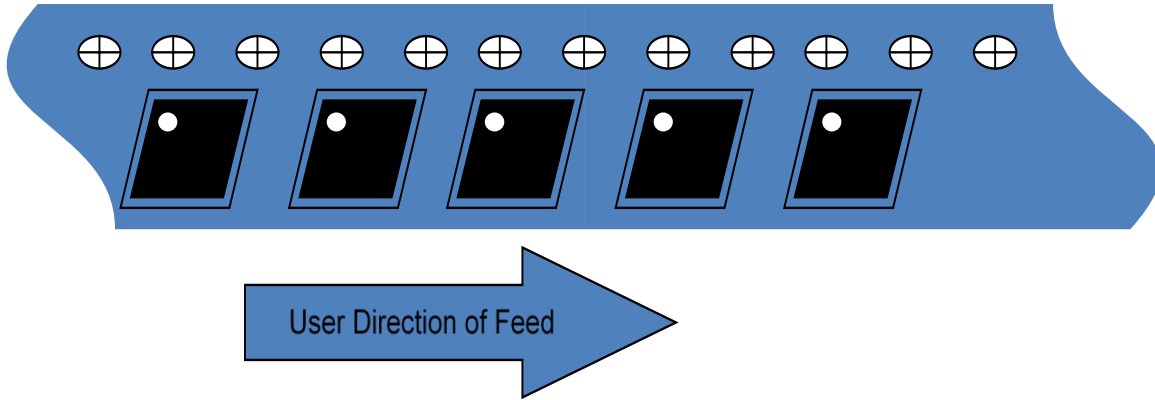

Feature	Measure	Symbol	Size (in)	Size (mm)
Cavity	Length	A0	0.128	3.25
	Width	B0	0.128	3.25
	Depth	K0	0.055	1.40
	Pitch	P1	0.157	4.00
Centerline Distance	Cavity to Perforation - Length Direction	P2	0.079	2.00
	Cavity to Perforation - Width Direction	F	0.217	5.50
Cover Tape	Width	C	0.362	9.20
Carrier Tape	Width	W	0.472	12.00

**Tape and Reel Information – Reel Dimensions**

Packaging reels are used to prevent damage to devices during shipping and storage, loaded carrier tape is typically wound onto a plastic take-up reel. The reel size is 7" diameter. The reels are made from high-impact injection-molded polystyrene (HIPS), which offers mechanical and ESD protection to packaged devices.

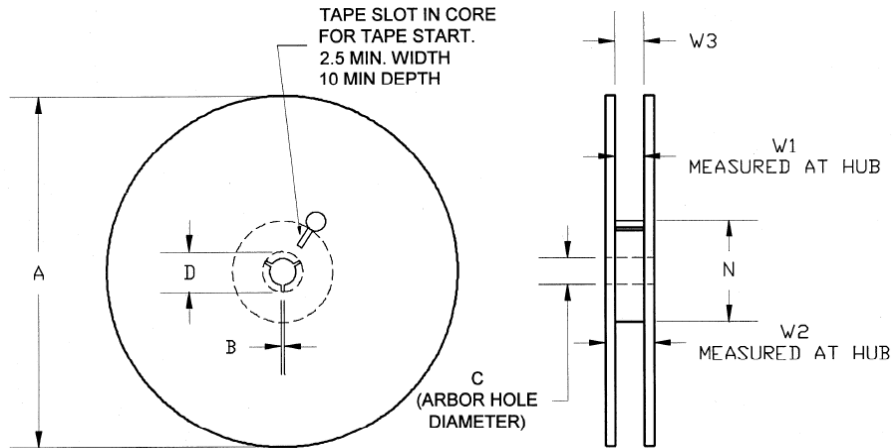

Feature	Measure	Symbol	Size (in)	Size (mm)
Flange	Diameter	A	6.969	177.0
	Thickness	W2	0.717	18.2
	Space Between Flange	W1	0.504	12.8
Hub	Outer Diameter	N	2.283	58.0
	Arbor Hole Diameter	C	0.512	13.0
	Key Slit Width	B	0.079	2.0
	Key Slit Diameter	D	0.787	20.0

**Tape and Reel Information – Tape Length and Label Placement**

Tape and reel specifications for this part are also available on the Qorvo website. Standard T/R size = 250 pieces on a 7" reel.

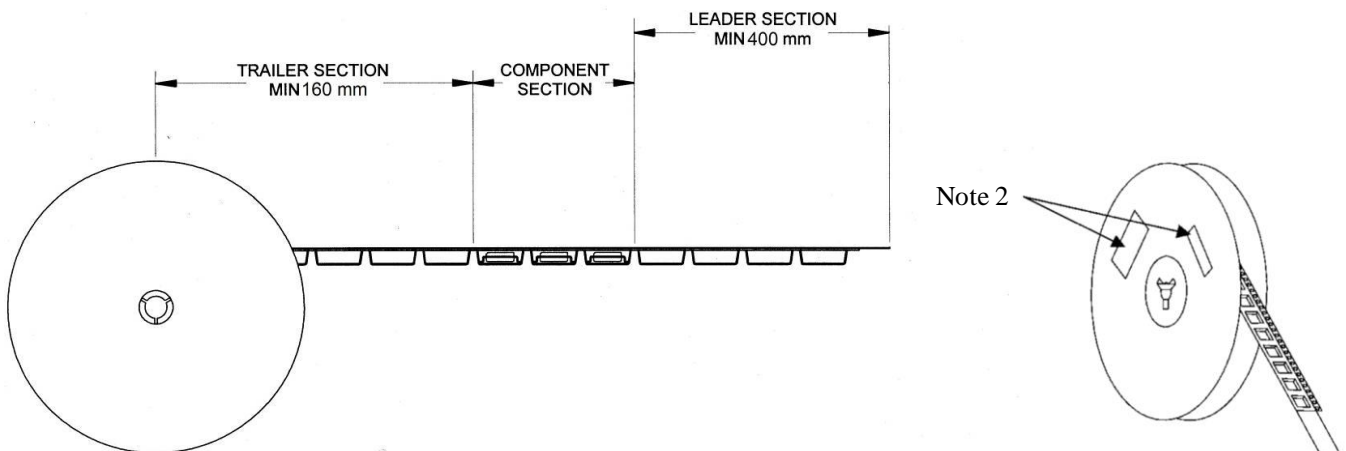

**Notes:**

1. Empty part cavities at the trailing and leading ends are sealed with cover tape. See EIA 481.
2. Labels are placed on the flange opposite the sprockets in the carrier tape.