

Product Overview

The QPA9122 is a wideband, high gain, and high peak power driver amplifier. It provides 36dB gain at 2.6GHz and achieves a peak power of 27dBm P3dB. With a quiescent current of 95mA, the amplifier can provide good DPD linearity performance with wideband signals of up to 160 MHz IBW making it perfectly suited for m-MIMO applications.

The QPA9122 is internally match to 50Ω over the entire operating frequency band of 2.3 – 5.0 GHz and incorporates a shut-down function through the V_{PD} pin.

The QPA9122 is housed in a 16-pin 3X3mm SMT package and is footprint and pin-compatible to QPA9120 and QPA9121.

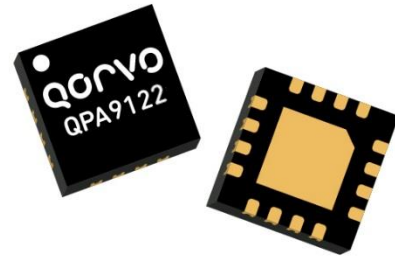

16 Pad 3 x 3 mm Laminate Package

Key Features

- 2.3–5.0 GHz Operational Frequency
- 50Ω Matched RF Input and Output
- +27 dBm P3dB
- 36.0 dB Gain at 2.6 GHz
- +5 V Single Supply, I_Q 95 mA
- DC Power Shutdown Feature

Functional Block Diagram

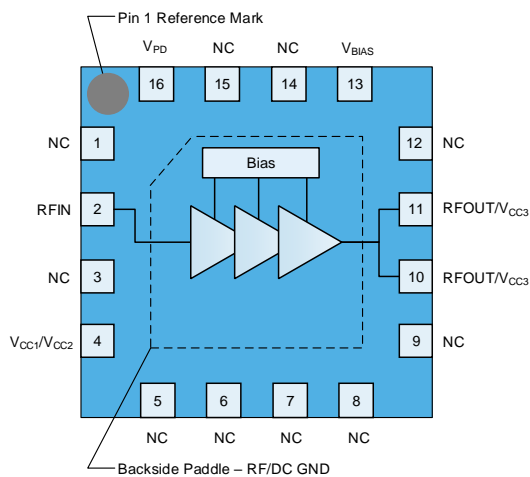

Top View

Applications

- 5G m-MIMO
- Mobile Infrastructure
- General Purpose Wireless
- TDD / FDD System

Ordering Information

Part No.	Description
QPA9122TR7	2500 pcs on 7" reel (standard)
QPA9122EVB-01	Evaluation Board

Absolute Maximum Ratings

Parameter	Rating
Storage Temperature	-65 to +150°C
T _{CASE}	-40 to +125°C
RF Input Power, ON state, CW, T=25 °C, 2:1 VSWR, In-band	+10 dBm
RF Input Power, OFF state, CW, T=25 °C, 2:1 VSWR, In-band	+10 dBm
Device Voltage (V _{CC1})	+6 V

Exceeding any one or a combination of the Absolute Maximum Rating conditions may cause permanent damage to the device. Extended application of Absolute Maximum Rating conditions to the device may reduce device reliability.

Recommended Operating Conditions

Parameter	Min	Typ	Max	Units
Supply Voltage (V _{CC})	+4.75	+5	+5.25	V
T _{CASE}	-40		+105	°C
T _j for >10 ⁶ hours MTTF			+218	°C

Electrical specifications are measured at specified test conditions. Specifications are not guaranteed over all recommended operating conditions. Operating the part above the maximum recommended T_{case} may degrade performance.

Electrical Specifications

Parameter	Conditions ⁽¹⁾	Min	Typ	Max	Units
Operational Frequency Range		2300		5000	MHz
Gain	At 2.6 GHz	33.7	36	39.7	dB
	At 3.6 GHz	34	36.5	40	dB
Gain Flatness	Any 100 MHz BW within band		0.8		dB
Input Return Loss			15		dB
Output Return Loss			12		dB
Reverse Isolation	ON state		50		dB
Forward Isolation	OFF state		45		dB
Output P _{1dB}	At 2.6 GHz	24.5	25.3		dBm
	At 3.6 GHz	25	26		dBm
Output P _{3dB}	At 2.6 GHz	25.5	26.9		dBm
	At 3.6 GHz	25.5	27		dBm
ACPR	At 2.6 GHz, P _{out} =+15 dBm, 1C LTE 20MHz, 8dB PAR		-45.7	-38	dBc
	At 3.6 GHz, P _{out} =+15 dBm, 1C LTE 20MHz, 8dB PAR		-39.5	-34	dBc
Noise Figure	At 3.6 GHz		5.3		dB
Device Current, ON	I _{CC} Quiescent Current	50	95	125	mA
Device Current, OFF	V _{PD} = 0 V		2		μA
V _{PD} , Logic Low		0		0.63	V
V _{PD} , Logic High		1.17		V _{CC}	V
Device ON or OFF Timing	50% Ctrl to 10/90% RF		0.45		μS
Thermal Resistance, θ _{jc}	Junction to case		65		°C/W

Notes:

1. Test conditions unless otherwise noted: V_{CC} = +5.0V, V_{PD} = +1.8V, Temp = +25 °C, 50 Ω system.

Evaluation Board - QPA9122EVB01

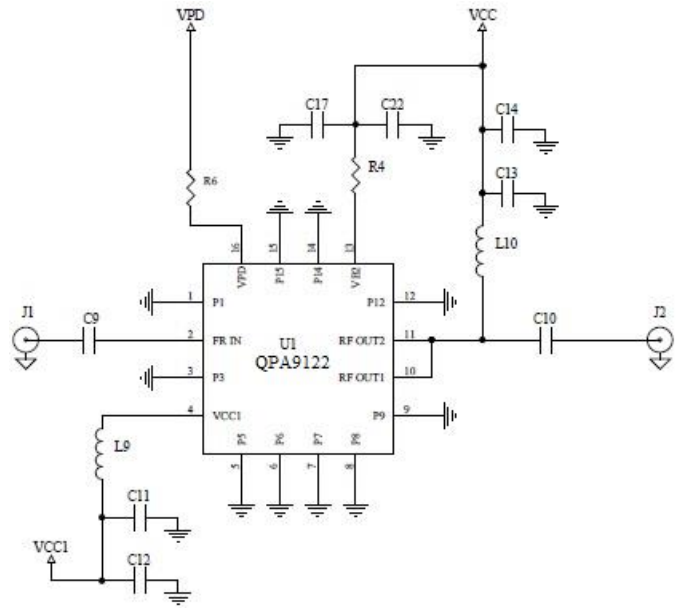
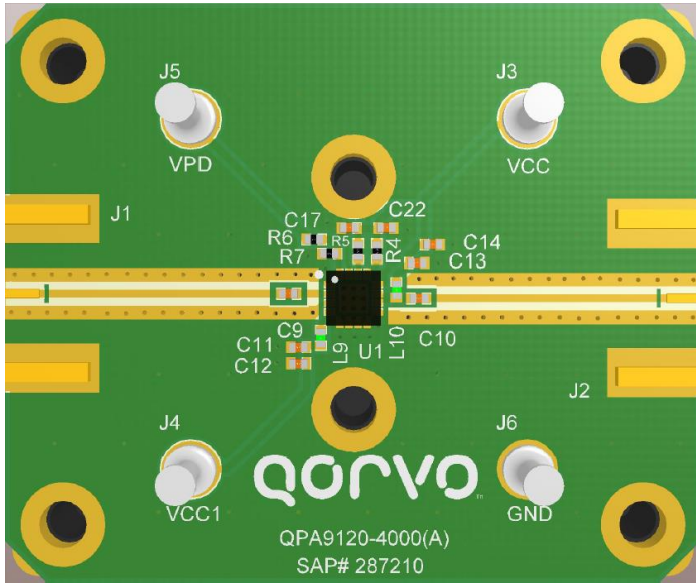

Notes:
1. Components shown on PCB layout but not on the schematic are not used.

Bill of Materials

Reference Des.	Value	Description	Manuf.	Part Number
n/a	-	Printed Circuit Board	Qorvo	
U1	-	High Gain Driver Amplifier	Qorvo	QPA9122
C9, C10	18 pF	CAP, 5%, 50V, C0G, 0402	Murata	GRM1555C1H180JA01D
C12, C14	1 μ F	CAP, 10V, X5R, CER, 0402	Various	
C11, C13, C17, C22	100 pF	CAP, 5%, 50V, C0G, 0402	Murata	GRM1555C1H101JA01D
R4	51 Ω	RES, 5%, 1/16W, 0402	Various	
R6	0 Ω	RES, 1/10W, 0402	Various	
L9	8.2 Ω	RES, 5%, 1/16W, 0402	Various	
L10	12 nH	IND, 5%, 0402	Coilcraft	0402CS-12NXJLW
J1, J2	-	Conn, SMA F STRT .062"	Cinch Connectivity	142-0701-851
R5, R7	DNP	n/a	n/a	n/a

Logic Table

Parameter, V_{PD}	High	Low
Device State	ON	OFF

Typical Performance

Parameter	Conditions	Typical Value			Units
		2600	3600	4900	
Frequency		2600	3600	4900	MHz
Gain		36.8	36	34	dB
Input Return Loss		16.6	16.7	18.9	dB
Output Return Loss		17.4	18.1	13.3	dB
Output P3dB		26.9	27.2	26.8	dBm
Output IP3	$P_{out} = +0$ dBm/tone, $\Delta f = 1$ MHz	32.4	32.9	30.0	dBm
ACPR	$P_{out} = +15$ dBm, 1C LTE, 20MHz, 8.5dB PAR	-46.1	-40.7	-38.1	dBc
Device Current	V_{CC} and V_{CC1} combined	95			mA

Notes:

1. Test Conditions unless otherwise noted: V_{CC} and V_{CC1} on EVB = +5.0V, $I_{CC} = 95$ mA, $V_{PD} = +1.8$ V, Temp.=+25 °C

Performance Plots – QPA9122EVB01

Test conditions unless otherwise noted: V_{CC} and V_{CC1} on EVB = +5.0 V, $I_{CC} = 95$ mA, $V_{PD} = +1.8$ V, Temp. = +25 °C

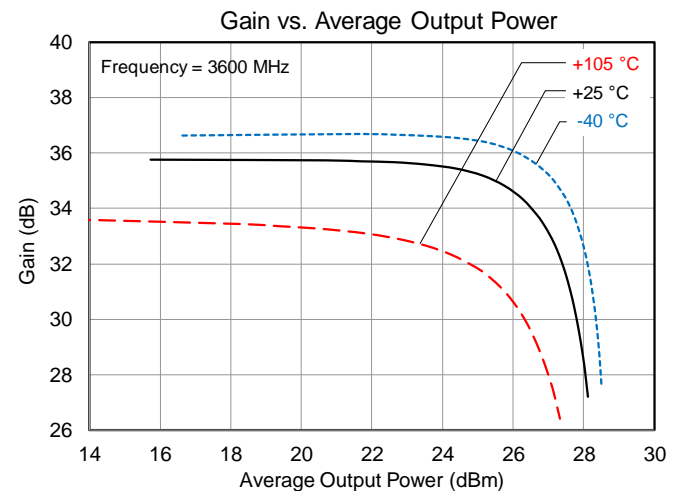
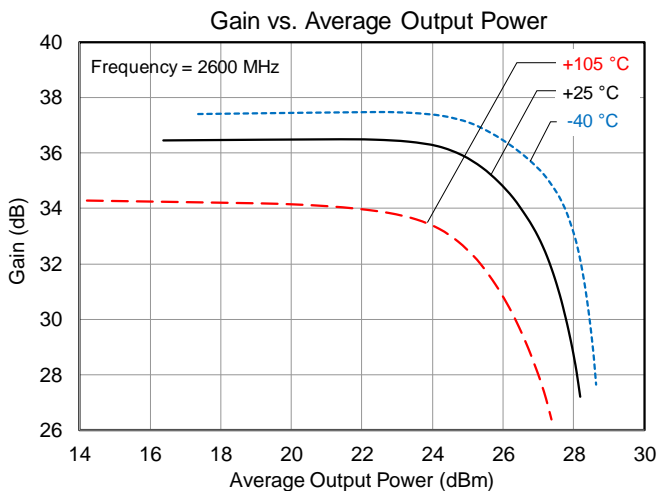
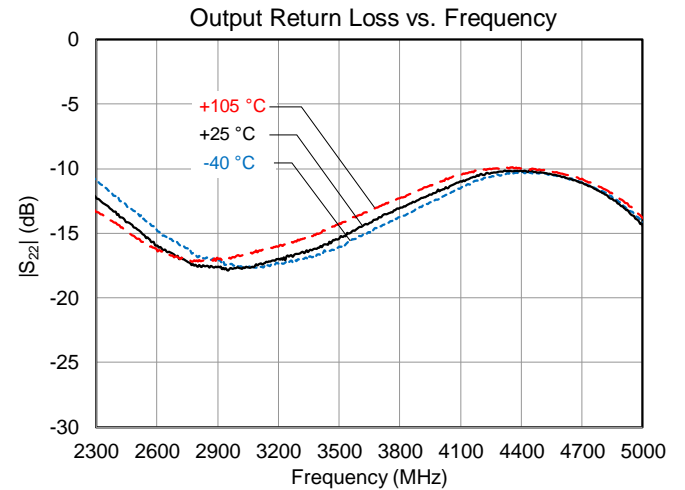
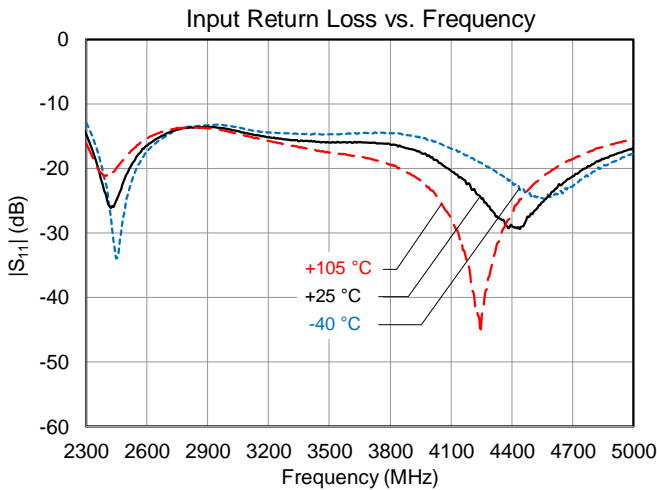
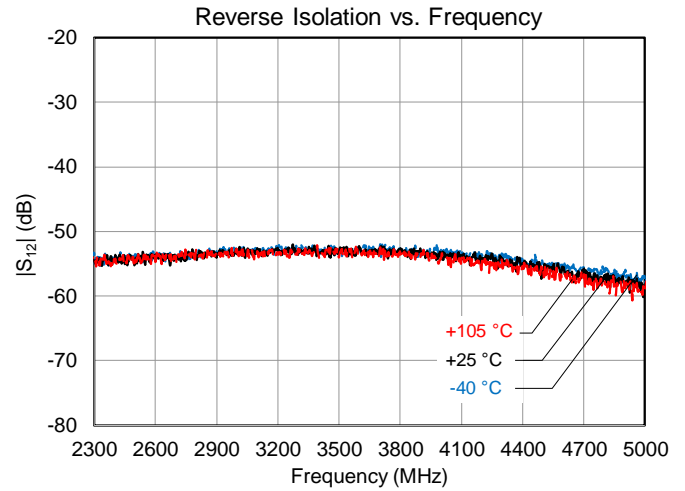
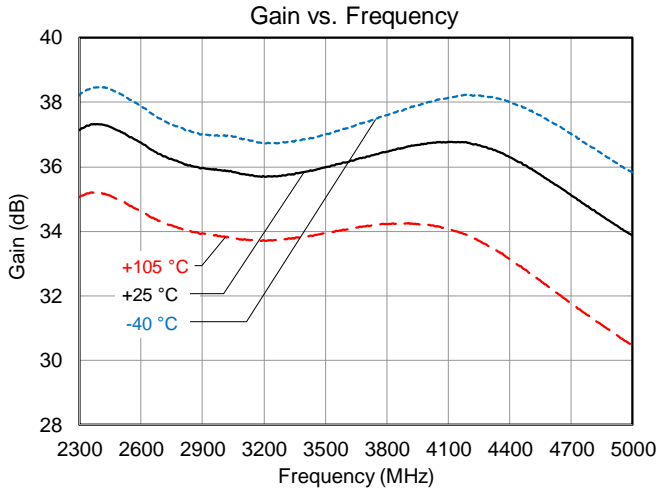

Performance Plots – QPA9122EVB01 (Continued)

Test conditions unless otherwise noted: V_{CC} and V_{CC1} on EVB = +5.0 V, I_{CC} = 95 mA, V_{PD} = +1.8 V, Temp. = +25 °C

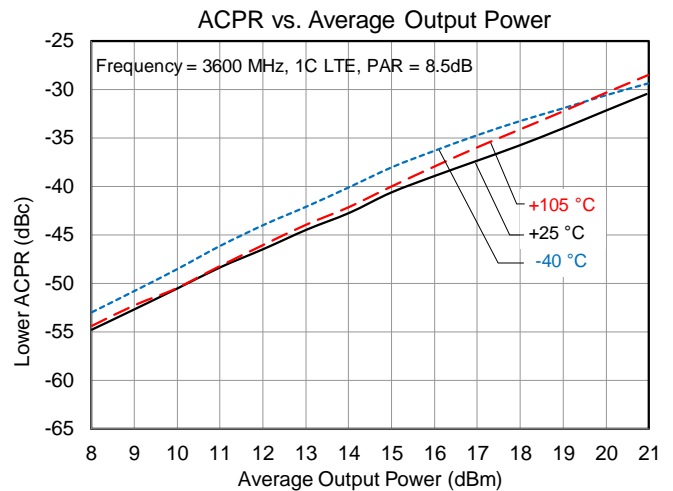
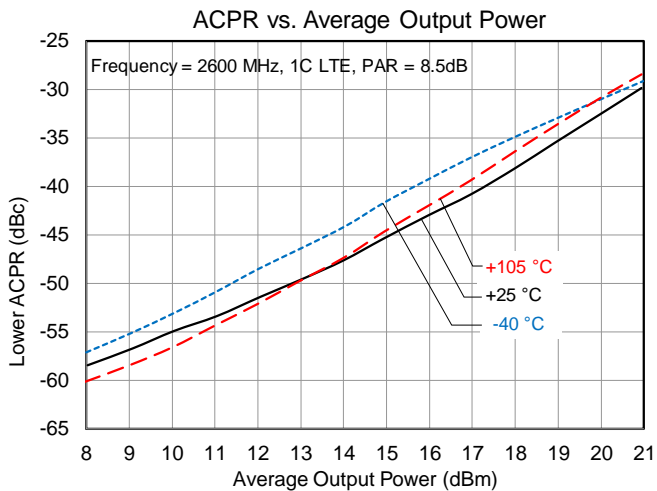
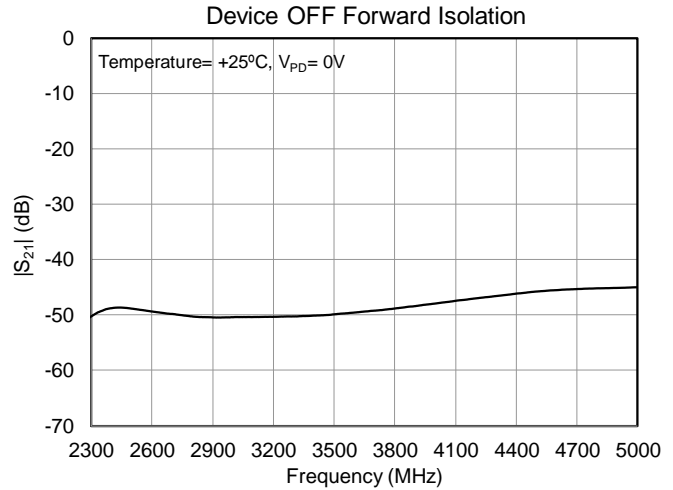
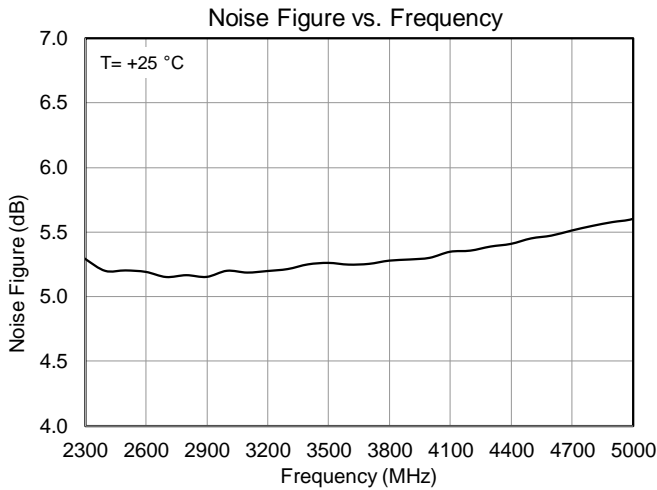
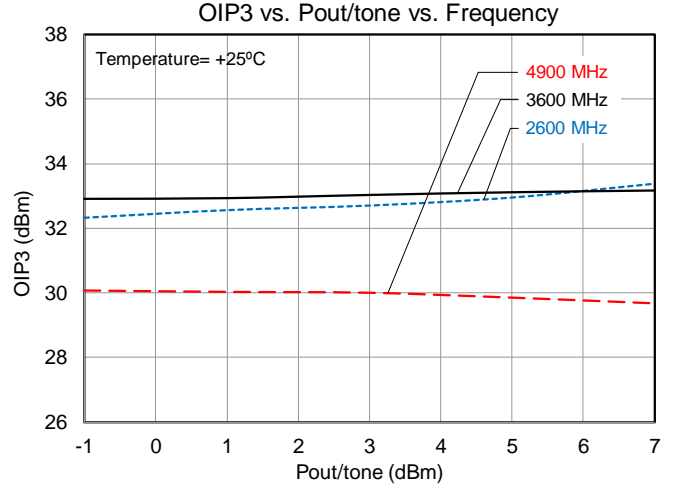
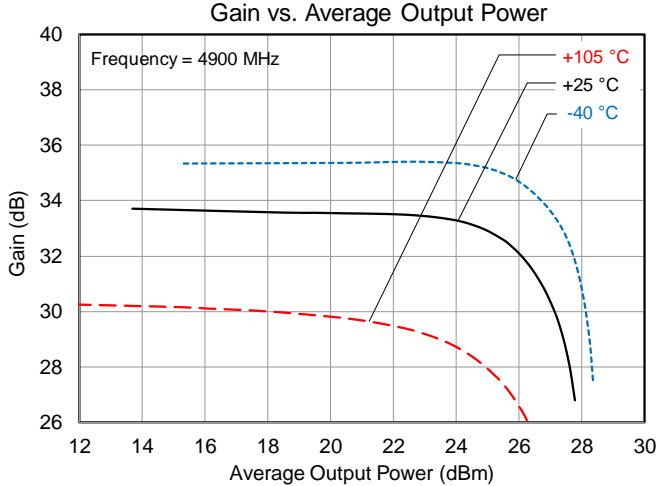

Performance Plots – QPA9122EVB01 (Continued)

Test conditions unless otherwise noted: V_{CC} and V_{CC1} on EVB = +5.0 V, $I_{CC} = 95$ mA, $V_{PD} = +1.8$ V, Temp. = +25 °C

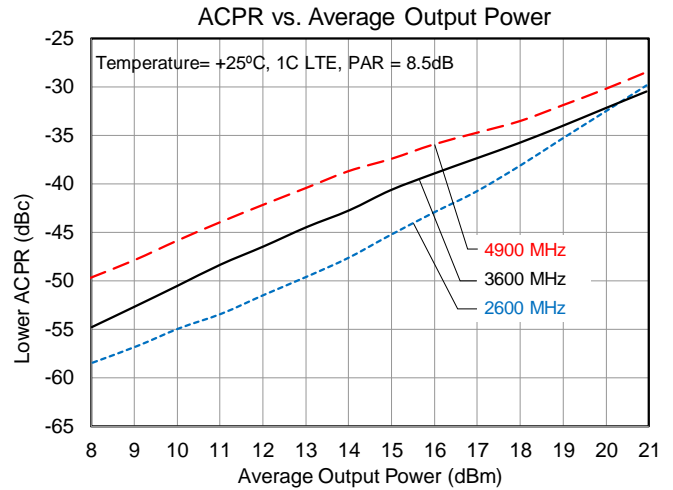
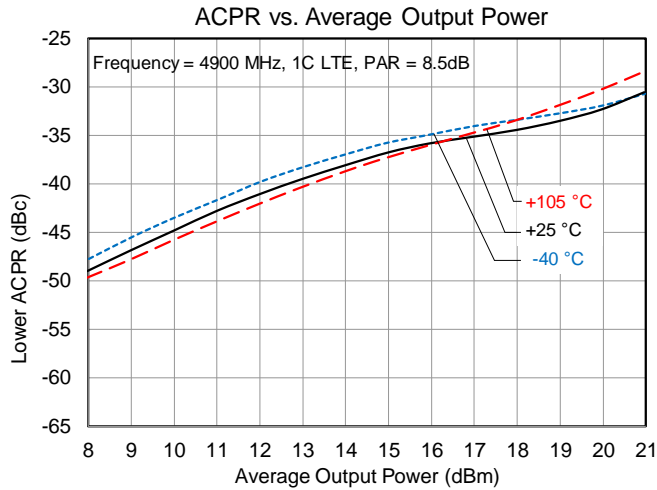

Pad Configuration and Description

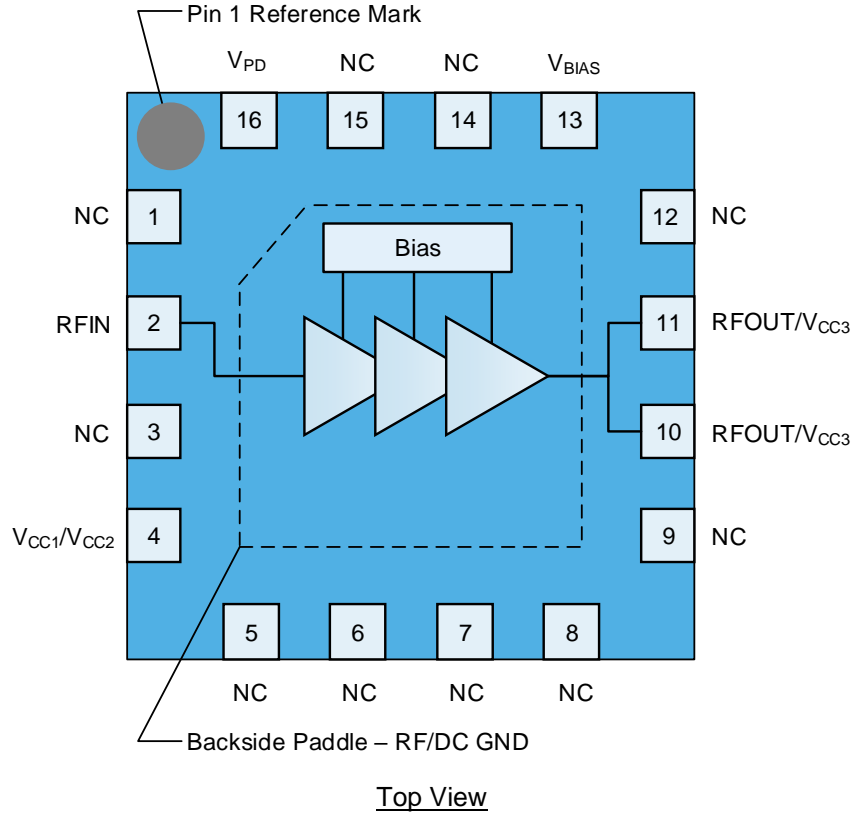

Pad No.	Label	Description
1, 3, 5, 6, 7, 8, 9, 12, 14, 15	NC	No electrical connection internally. It may be left floating or connected to ground. Land pads should be provided for PCB mounting integrity.
2	RF IN	RF input. External DC block required.
4	V _{CC1} / V _{CC2}	First and second stage DC supply.
10, 11	RFOUT / V _{CC3}	RF output and third stage DC supply. External choke and DC block capacitor required.
13	V _{BIAS}	Bias circuit supply voltage.
16	V _{PD}	PA on/off logic control.
Backside Paddle	GND	RF/DC ground connection. The back side of the package should be connected to the ground plane through as short of a connection as possible. PCB vias under the device as many as possible are recommended.

Package Marking and Dimensions

Marking: Part Number – A9122
 Trace Code – XXXX up to 4 Characters assigned by sub-contractor

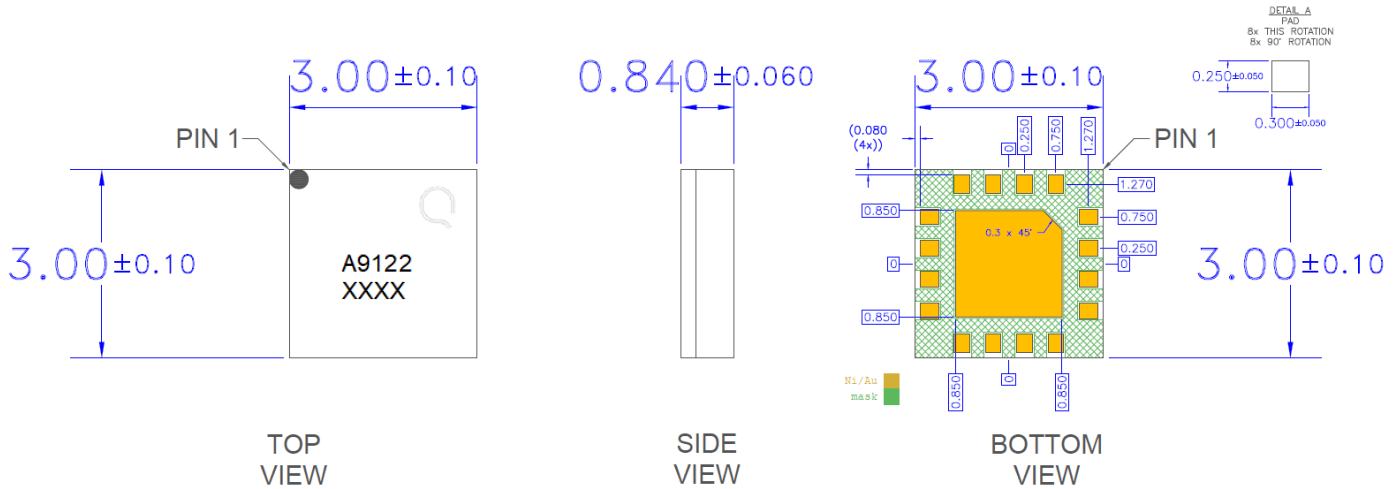

- Notes:
2. All dimensions are in millimeters. Angles are in degrees.
 3. The terminal #1 identifier and terminal numbering conform to SPE-000677.
 4. Contact plating: ENEPIG

Recommended PCB Layout Pattern

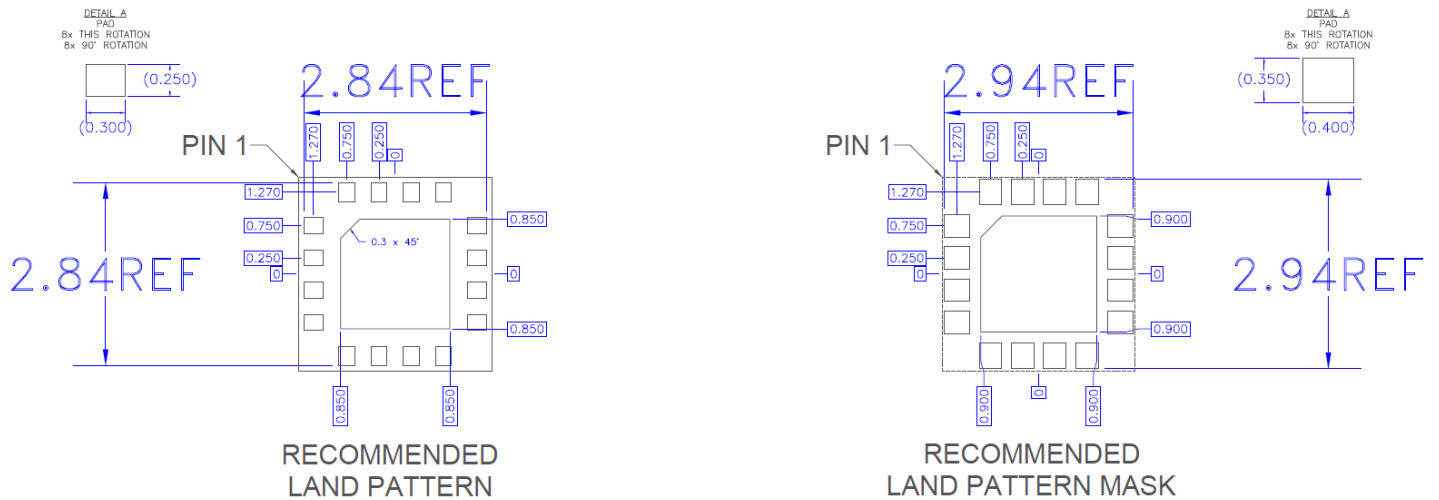

- Notes:
1. All dimensions are in millimeters. Angles are in degrees.
 2. Use 1 oz. copper minimum for top and bottom layer metal.
 3. Via holes are required under the backside paddle of this device for proper RF/DC grounding and thermal dissipation. We recommend a 0.35mm (#80/.0135") diameter bit for drilling via holes and a final plated thru diameter of 0.25 mm (0.01").
 4. Ensure good package backside paddle solder attach for reliable operation and best electrical performance.

Tape and Reel Information – Carrier and Cover Tape Dimensions

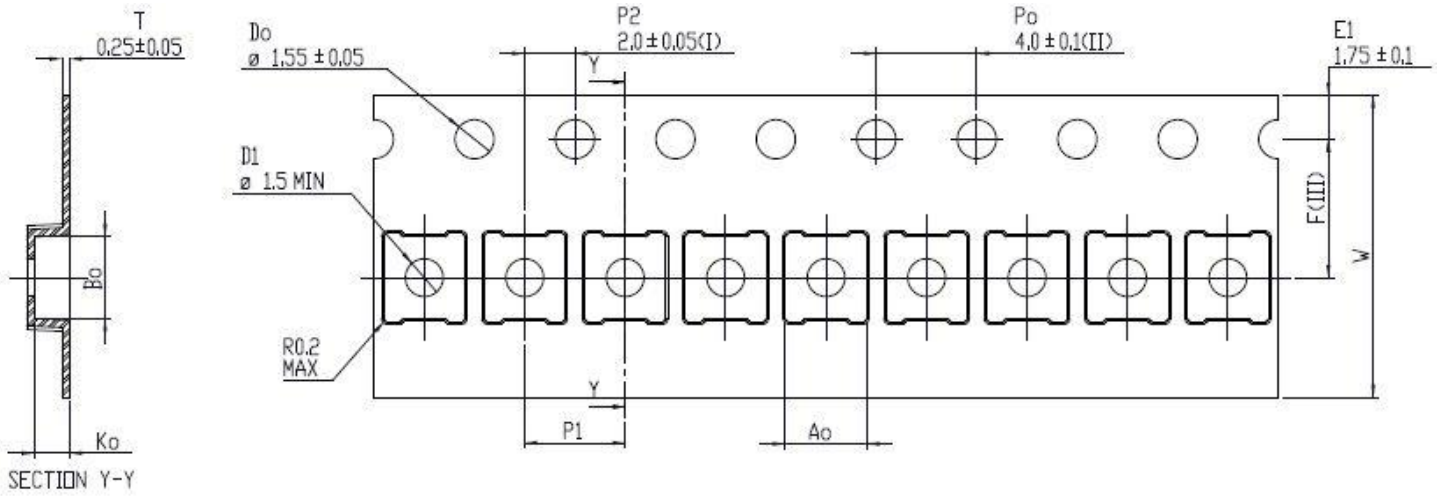

Feature	Measure	Symbol	Size (in)	Size (mm)
Cavity	Length	A0	0.128	3.25
	Width	B0	0.128	3.25
	Depth	K0	0.055	1.40
	Pitch	P1	0.157	4.00
Centerline Distance	Cavity to Perforation - Length Direction	P2	0.079	2.00
	Cavity to Perforation - Width Direction	F	0.217	5.50
Cover Tape	Width	C	0.362	9.20
Carrier Tape	Width	W	0.472	12.00

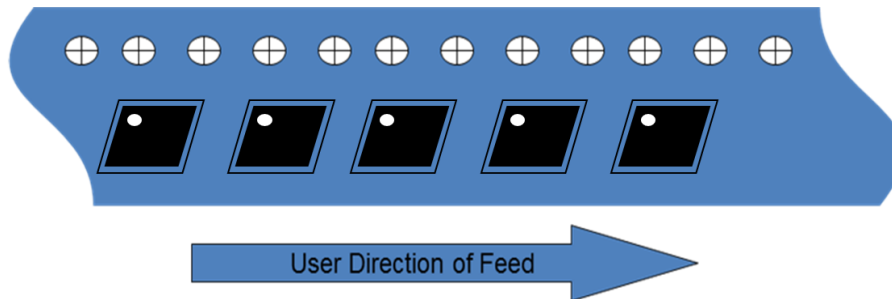

Tape and Reel Information – Reel Dimensions

Standard T/R size = 2,500 pieces on a 7" reel.

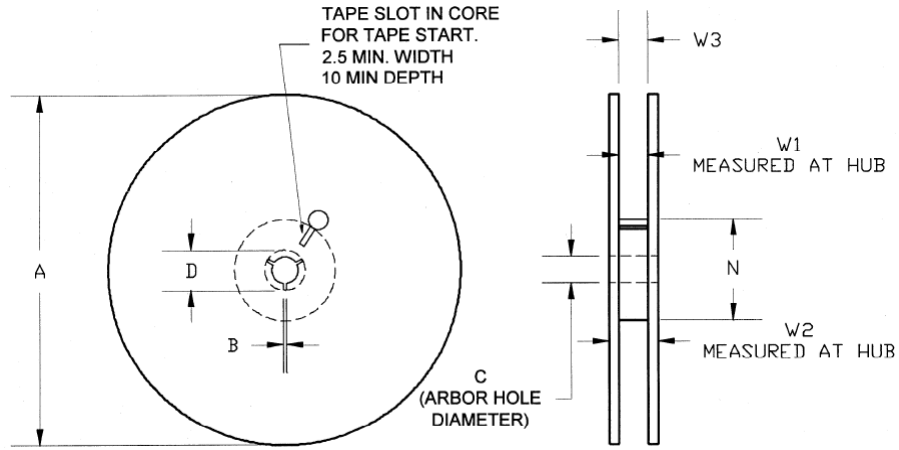

Feature	Measure	Symbol	Size (in)	Size (mm)
Flange	Diameter	A	6.969	177.0
	Thickness	W2	0.717	18.2
	Space Between Flange	W1	0.504	12.8
Hub	Outer Diameter	N	2.283	58.0
	Arbor Hole Diameter	C	0.512	13.0
	Key Slit Width	B	0.079	2.0
	Key Slit Diameter	D	0.787	20.0

Tape and Reel Information – Tape Length and Label Placement



- Notes:
1. Empty part cavities at the trailing and leading ends are sealed with cover tape. See EIA 481-1-A.
 2. Labels are placed on the flange opposite the sprockets in the carrier tape.