

Product Description

The QPB0220J is a solid state driver amplifier based on GaN MMIC technology, with an operating range of 2 – 18 GHz with a saturated output power of 39.1 dBm (8 Watts). Its compact size and weight allow it to be used to drive a number of Spatium power amplifiers in microwave high power transmitters for EW and radar applications.

Planar multistage driver module for use with existing Spatium platforms operating in the 2 – 18 GHz frequency band. A variable attenuator in conjunction with a temperature sensor compensates for variation in gain over the operating temperature range. Gate bias and variable attenuator settings are digitally programmable using non-volatile I2C digital potentiometers. RF input and output are via SMA connectors. DC and control interface is provided via a Micro D-Sub connector.

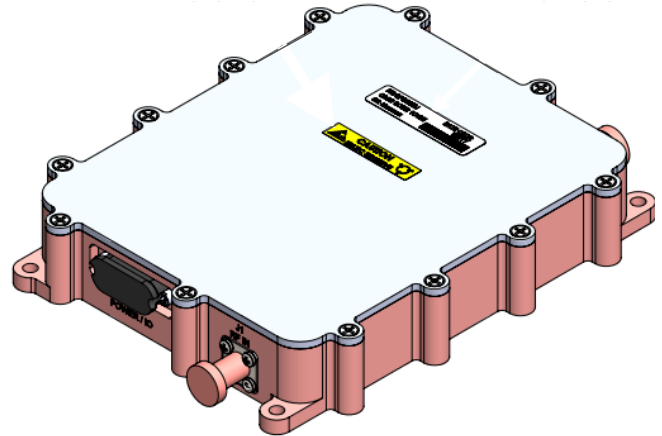

Functional Block Diagram

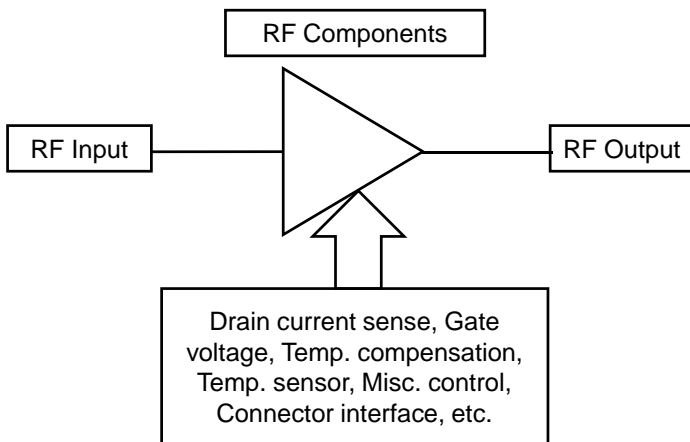

Product Features

- Frequency Range: 2 – 18 GHz
- Saturated Output Power: 39.1 dBm ($P_{IN} = 14$ dBm)
- Solid State MMIC Reliability
- Instant On (no warm-up)

Performance is typical across frequency. Please reference electrical specification table and data plots for more details.

Applications

- Spatium Driver Amplifier

Ordering Information

Part No.	Description
QPB0220J	2 – 18 GHz GaN Driver Amplifier

Absolute Maximum Ratings

Parameter	Value / Range
Prime Power (V_{DC})*	22 V
Drain Current (I_{D_DRIVE})	5.6 A
Max. RF Input Power	30 dBm
Storage Temperature	-40 to +85 °C

Operation of this device outside the parameter ranges given above may cause permanent damage. These are stress ratings only, and functional operation of the device at these conditions is not implied.

* Rating for thermal reliability

Recommended Operating Conditions

Parameter	Value / Range
Drain Voltage (V_D)	18 V
Quiescent Drain Current (I_{DQ})	4 A
Operating Drain Current (I_D)	5 A
Operating Temperature**:	18 V, 20 V 22 V
	-40 to +71 °C -40 to +50 °C

Electrical specifications are measured at specified test conditions. Specifications are not guaranteed over all recommended operating conditions.

** Refers to outside clamp surface temperature

Electrical Specifications

Test conditions unless otherwise noted: $V_D = 18$ V, $I_{DQ} = 4$ A, $T_{CLAMP} = 25$ °C, CW Operation

Parameter	Min	Typ	Max	Units
Frequency	2		18	GHz
Saturated P_{OUT} , CW ($P_{IN} = 14$ dBm)		39.1		dBm
Power-Added Efficiency, CW ($P_{IN} = 14$ dBm)		18.8		%
Power Gain, CW ($P_{IN} = 14$ dBm)		25.1		dB
Small Signal Gain		27		dB
Input Return Loss		13		dB
Second Harmonic, CW (In band, $P_{IN} = 14$ dBm)		-22		dBc
Third Harmonic, CW (In band, $P_{IN} = 14$ dBm)		-13		dBc
Pulse Propagation Delay (50% of V_{ENABLE} to the 90%/10% pt. of the RF Pulse; $P_{IN} = 14$ dBm)		200		ns
Input RF Interface	SMA (F)			
Output RF Interface	SMA (F)			
Weight – Amplifier Unit	3.90 (1.77)			lbs. (kg)
Dimensions – Amplifier Unit (L) x (W) x (H)	5.818 x 4.635 x 1.020			inches
	147.8 x 117.7 x 25.9			millimeters

Typical Performance – Large Signal (CW)

Test conditions unless otherwise noted: $V_D = 18\text{ V}$, $I_{DQ} = 4\text{ A}$, $T_{CLAMP} = 25\text{ °C}$, CW Operation

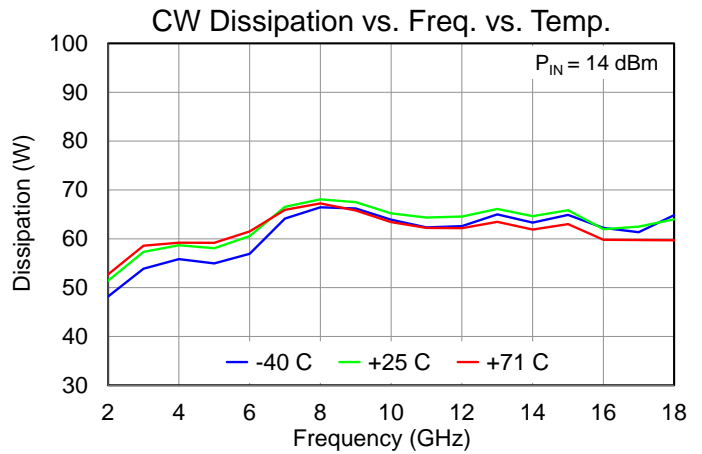
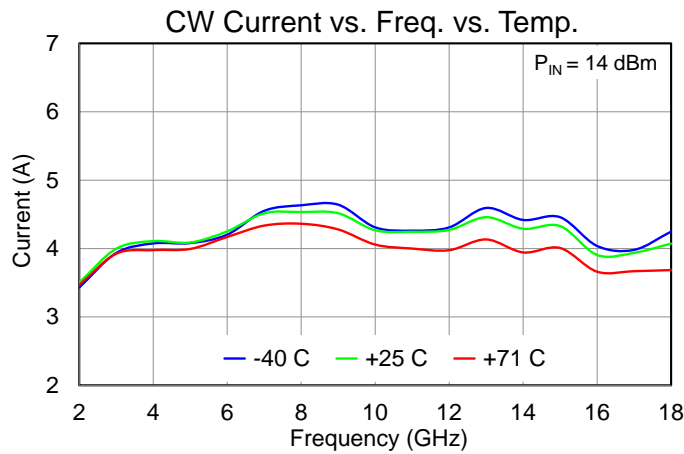
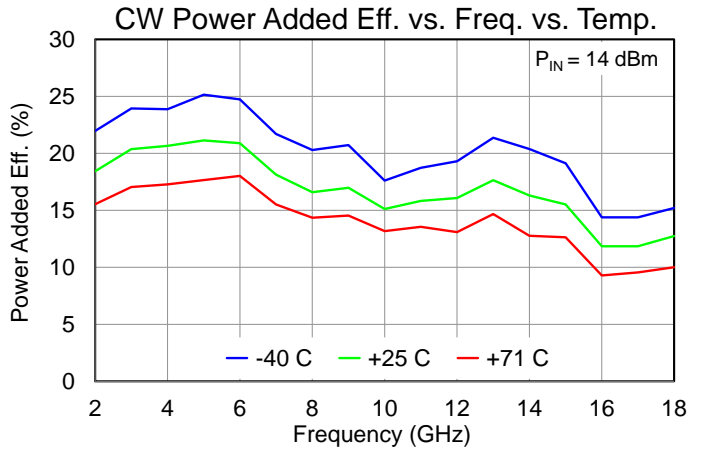
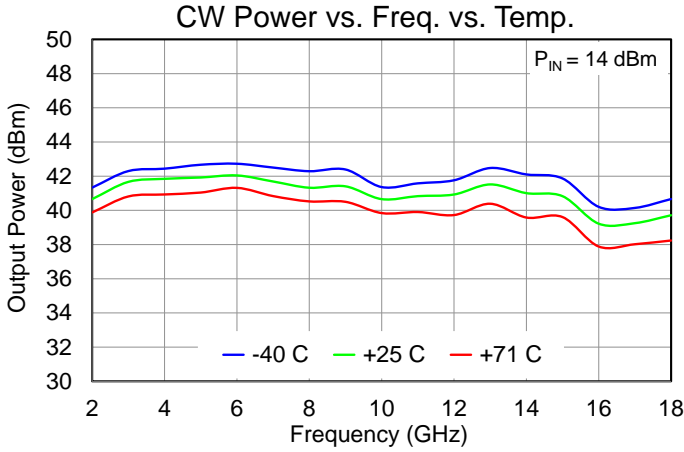

Typical Performance – Large Signal (CW)

Test conditions unless otherwise noted: $V_D = 18\text{ V}$, $I_{DQ} = 4\text{ A}$, $T_{CLAMP} = 25\text{ °C}$, CW Operation

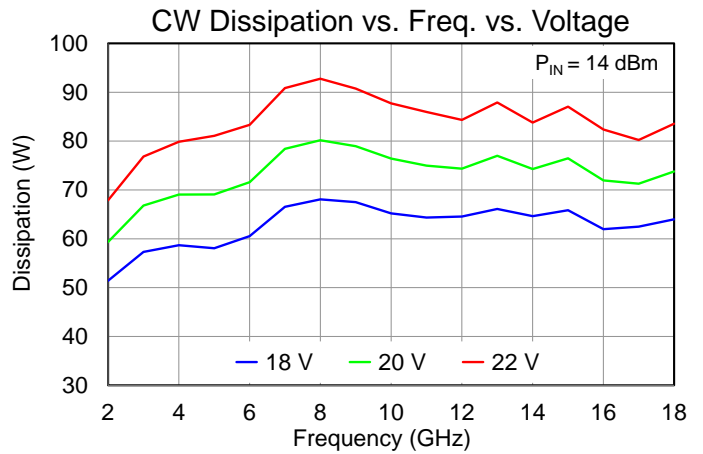
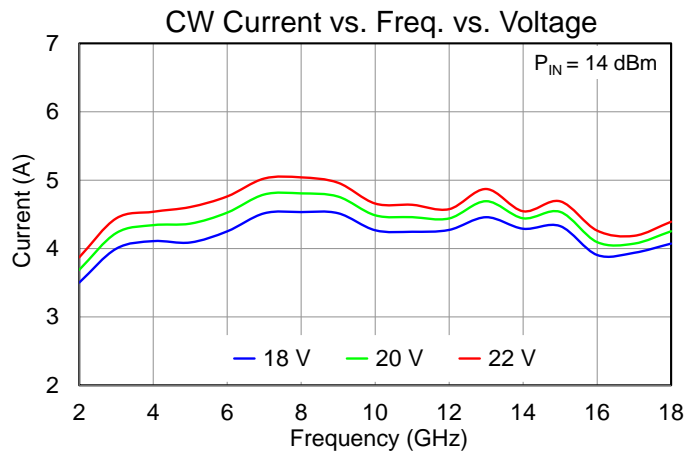
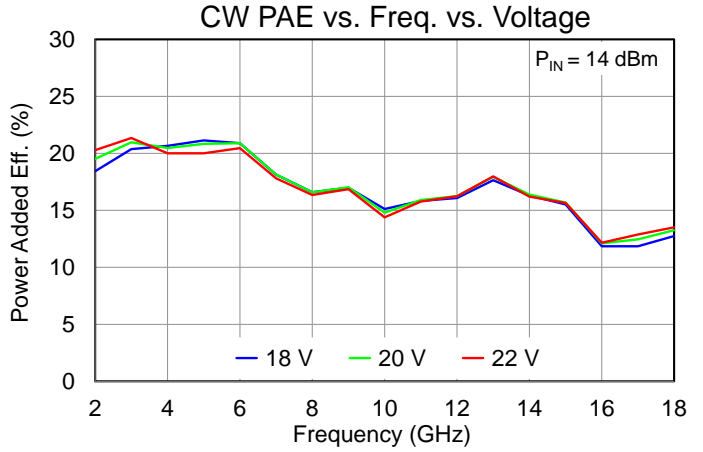
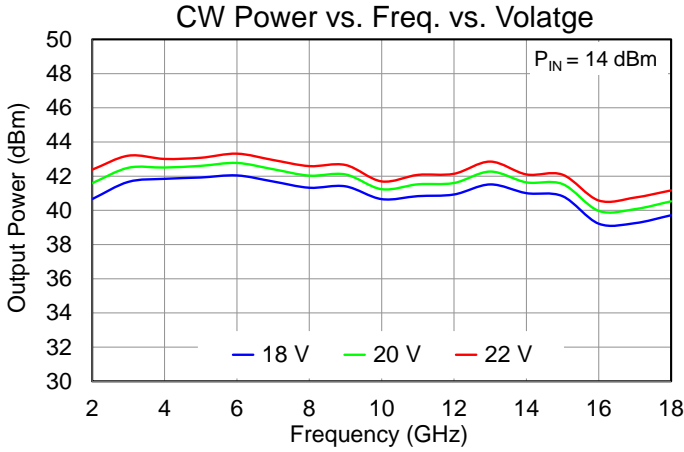

Typical Performance – Large Signal (CW)

Test conditions unless otherwise noted: $V_D = 18\text{ V}$, $I_{DQ} = 4\text{ A}$, $T_{CLAMP} = 25\text{ °C}$, CW Operation

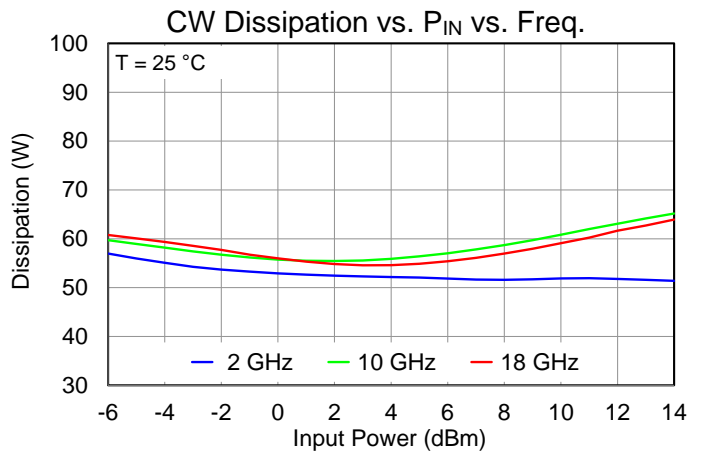
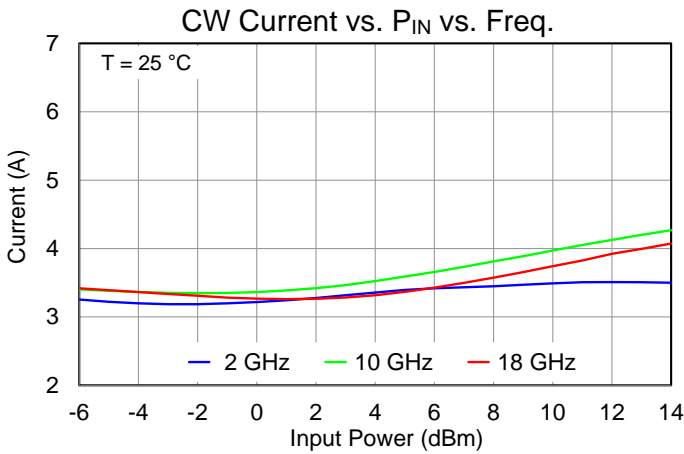
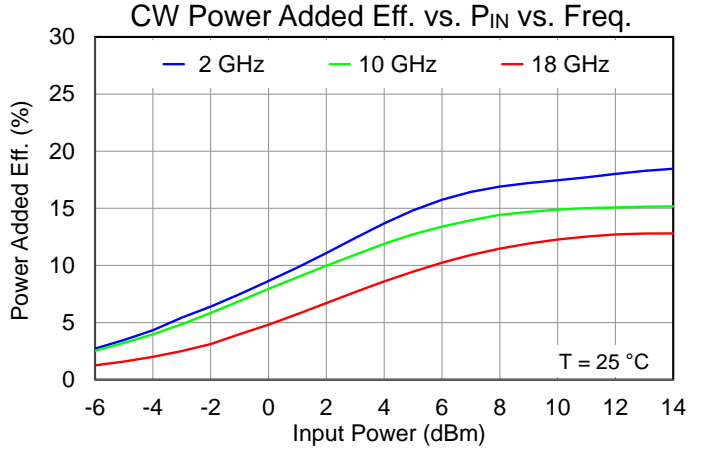
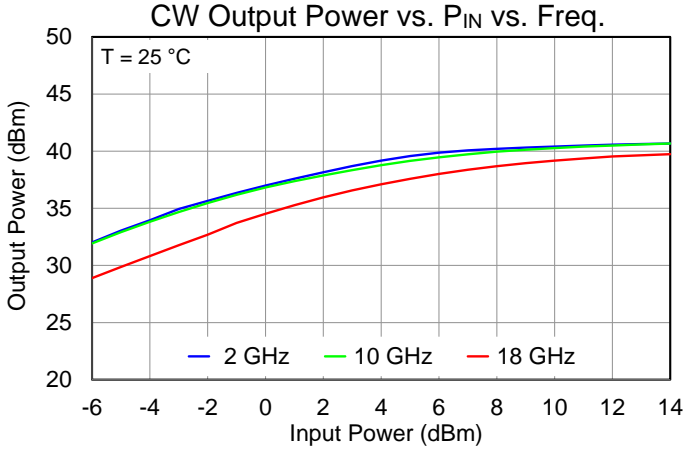

Typical Performance – Large Signal (CW)

Test conditions unless otherwise noted: $V_D = 18\text{ V}$, $I_{DQ} = 4\text{ A}$, CW Operation

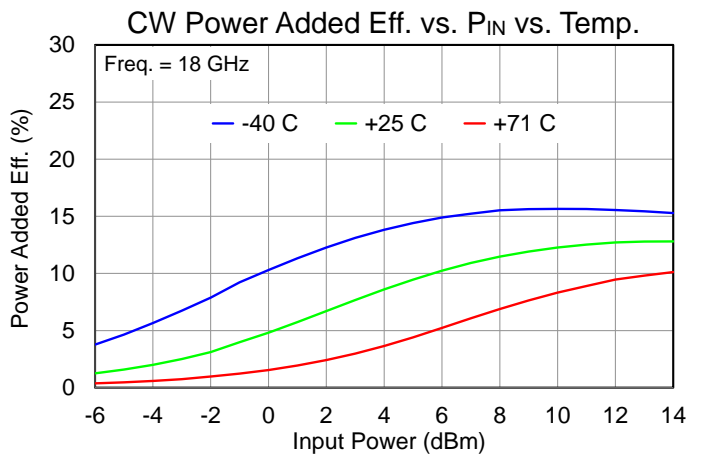
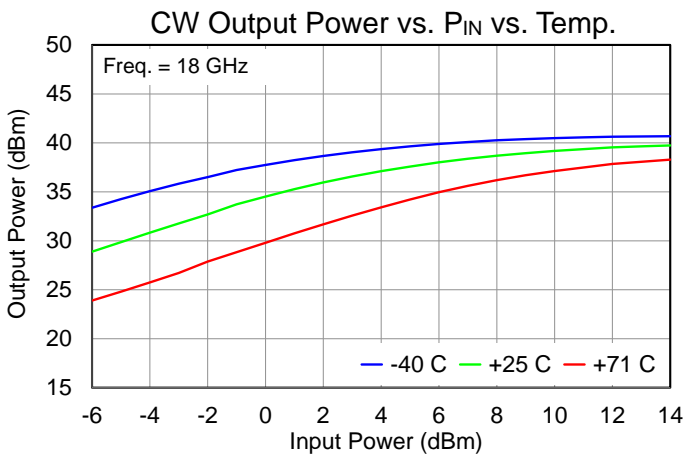
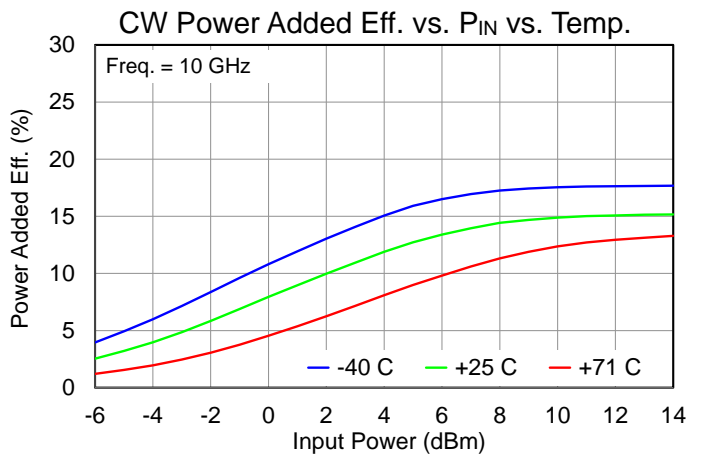
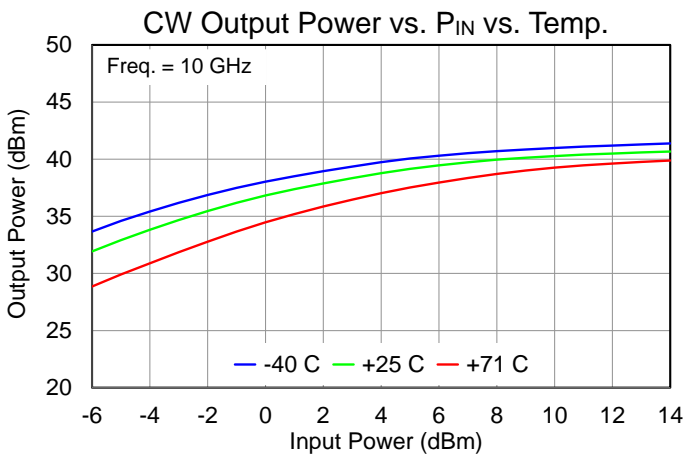
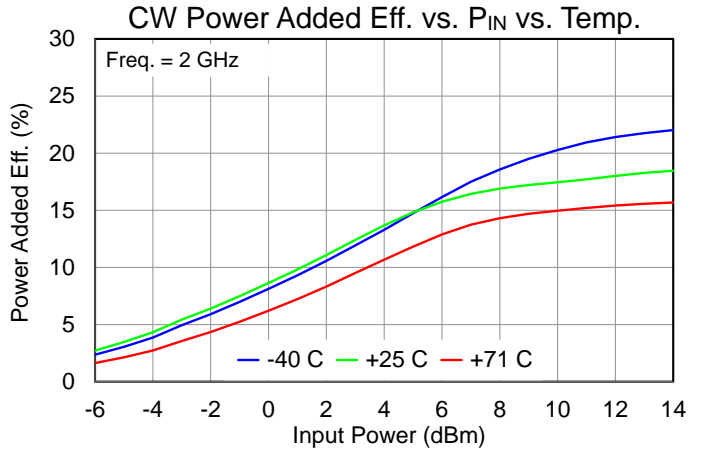
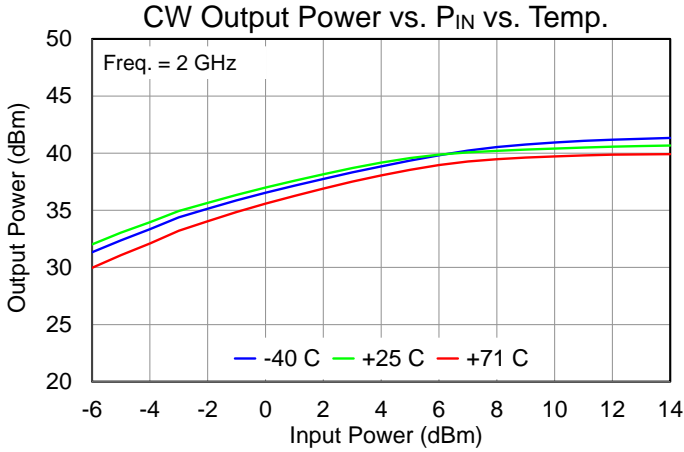

Typical Performance – Large Signal (Pulsed)

Test conditions unless otherwise noted: $V_D = 18\text{ V}$, $I_{DQ} = 4\text{ A}$, $T_{CLAMP} = 25\text{ }^\circ\text{C}$, Pulse Width = 500 ns, Duty Cycle = 50%

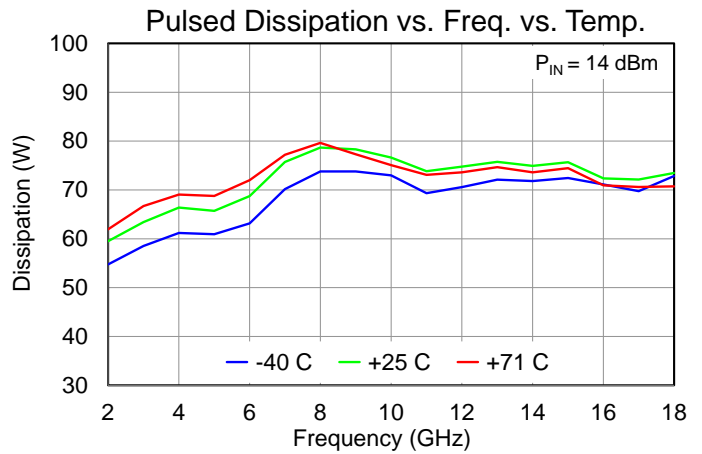
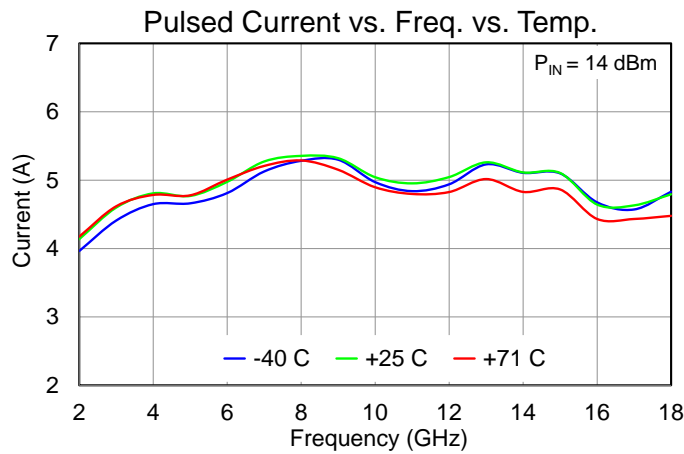
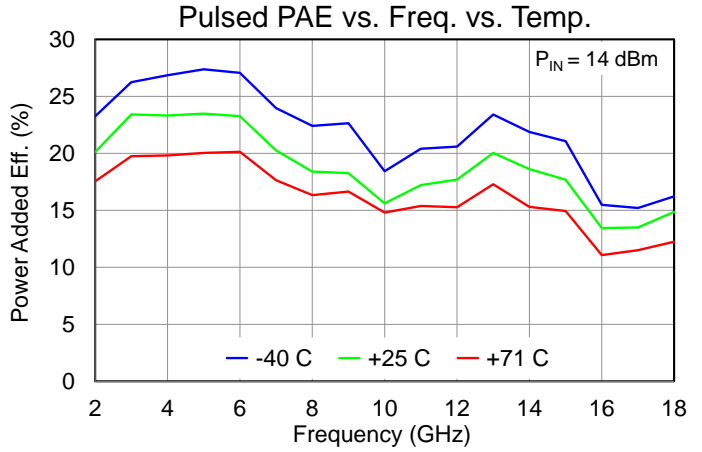
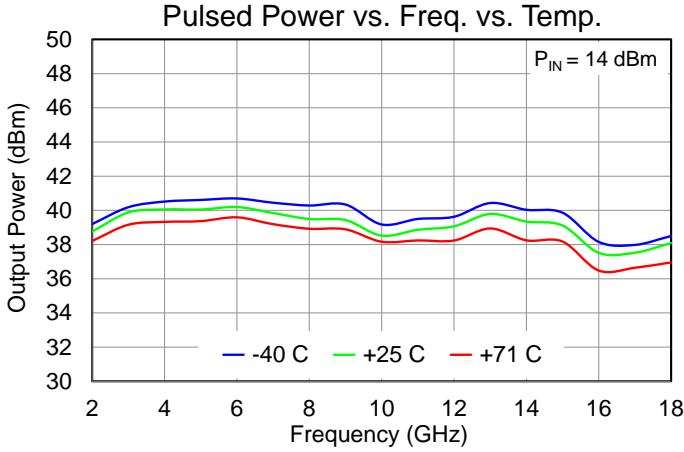

Typical Performance – Large Signal (Pulsed)

Test conditions unless otherwise noted: $V_D = 18\text{ V}$, $I_{DQ} = 4\text{ A}$, $T_{CLAMP} = 25\text{ }^\circ\text{C}$, Pulse Width = 500 ns, Duty Cycle = 50%

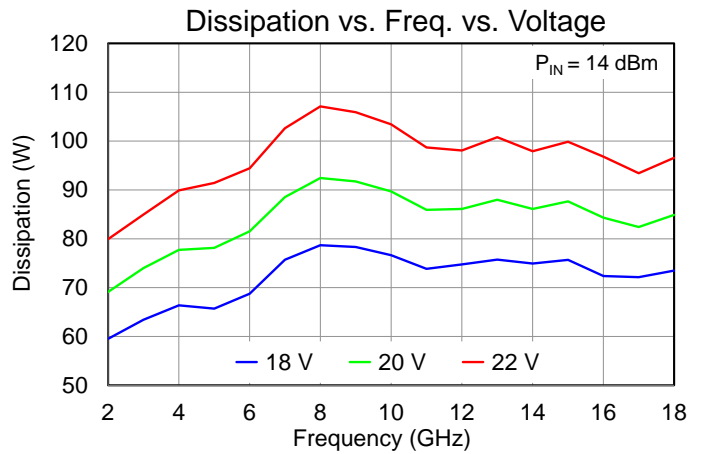
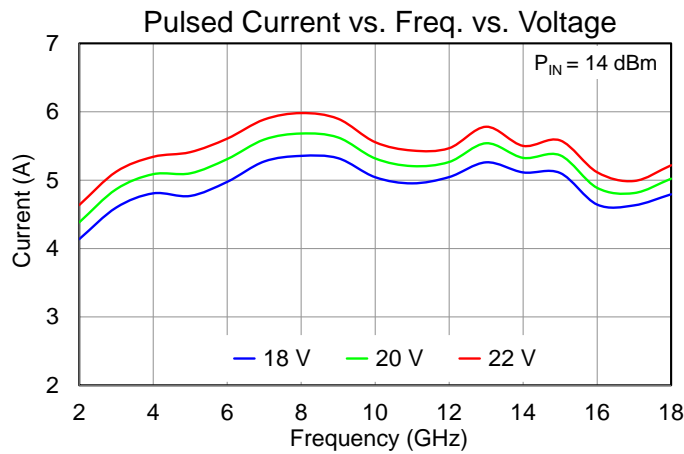
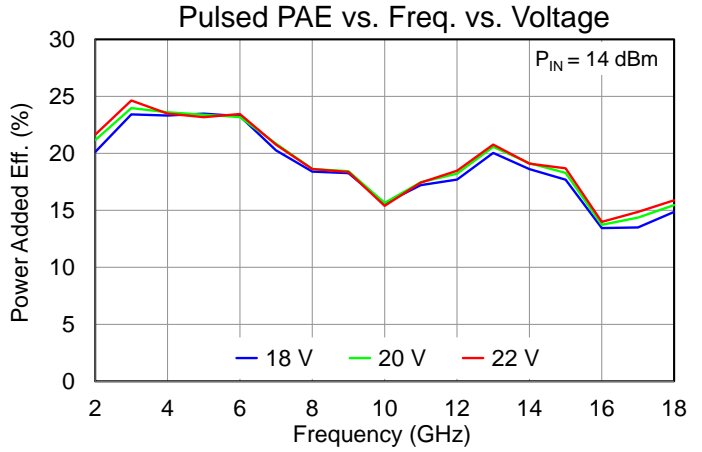
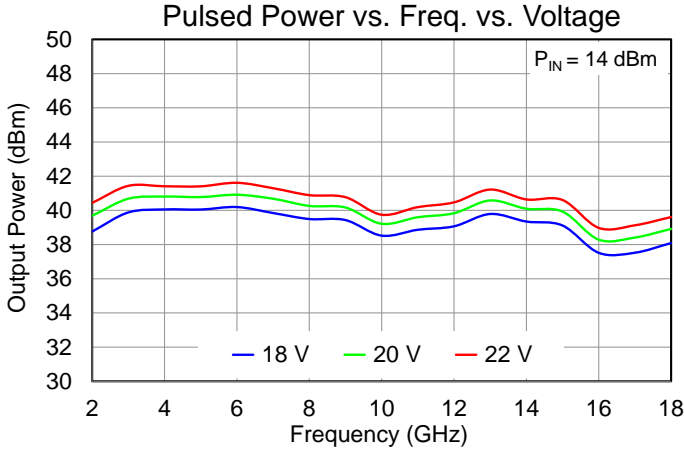

Typical Performance – Large Signal (Pulsed)

Test conditions unless otherwise noted: $V_D = 18\text{ V}$, $I_{DQ} = 4\text{ A}$, $T_{CLAMP} = 25\text{ °C}$, Pulse Width = 500 ns, Duty Cycle = 50%

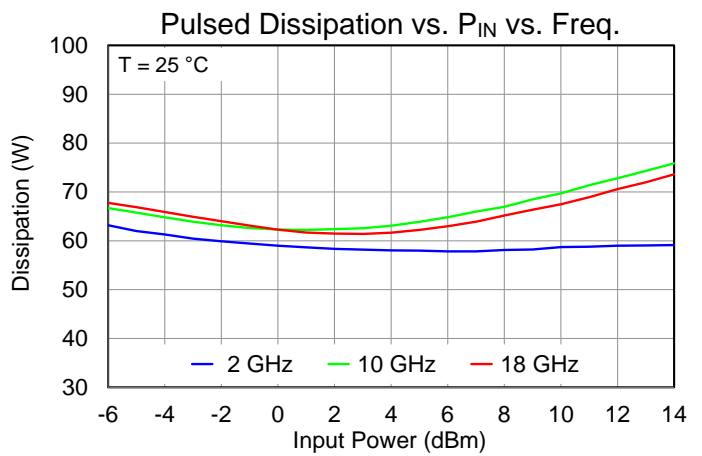
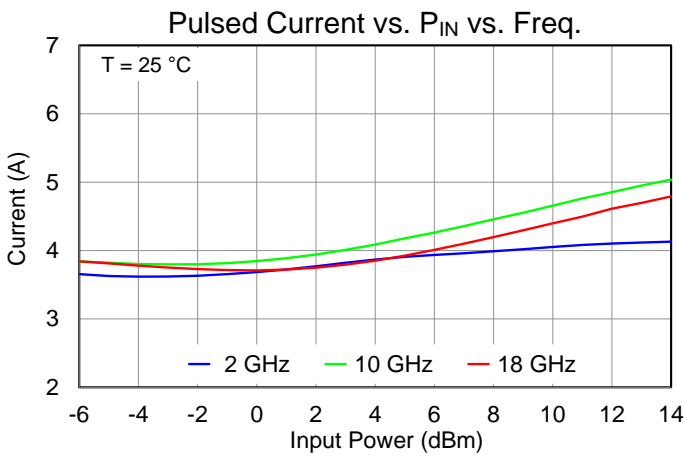
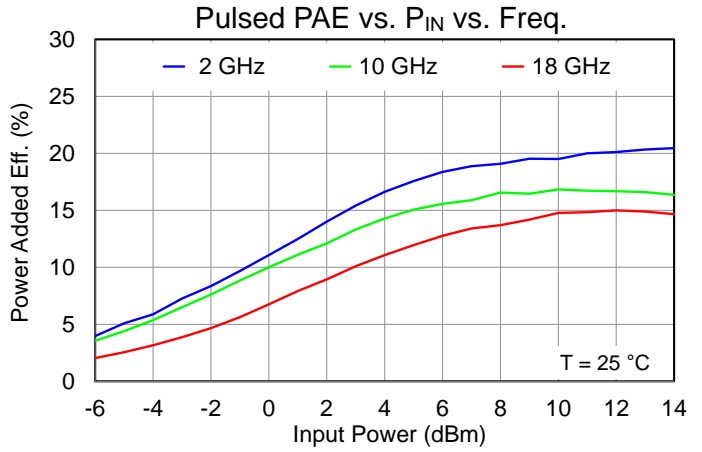
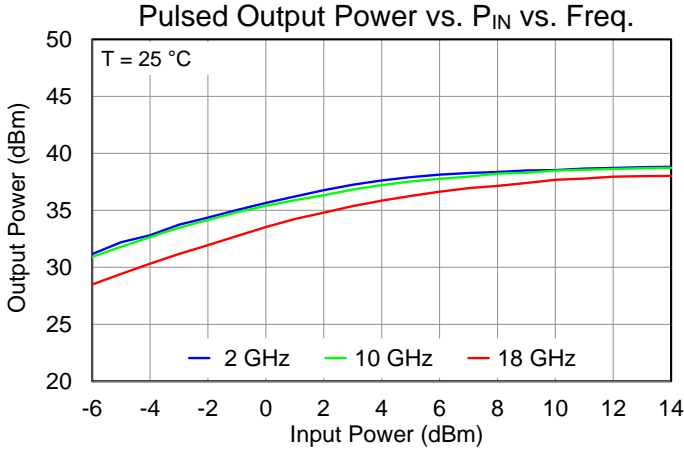

Typical Performance – Large Signal (Pulsed)

Test conditions unless otherwise noted: $V_D = 18\text{ V}$, $I_{DQ} = 4\text{ A}$, $T_{CLAMP} = 25\text{ °C}$, Pulse Width = 500 ns, Duty Cycle = 50%

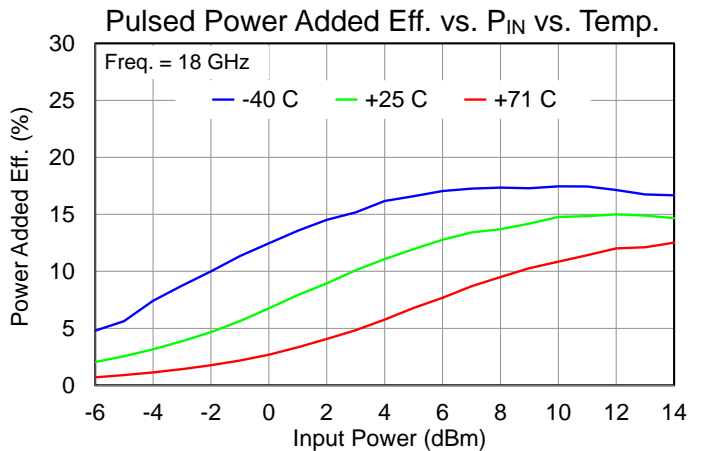
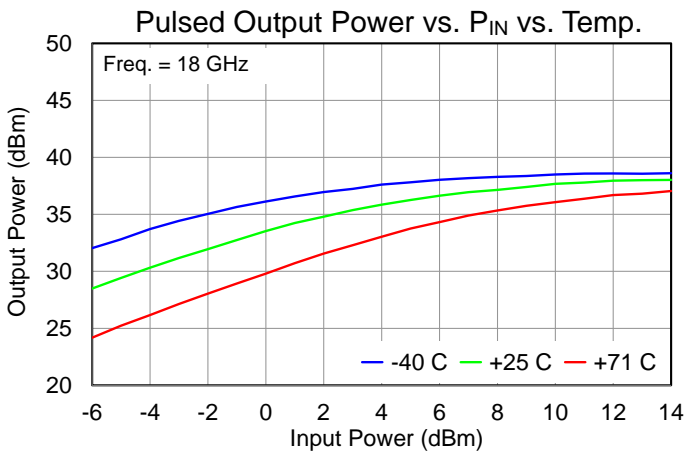
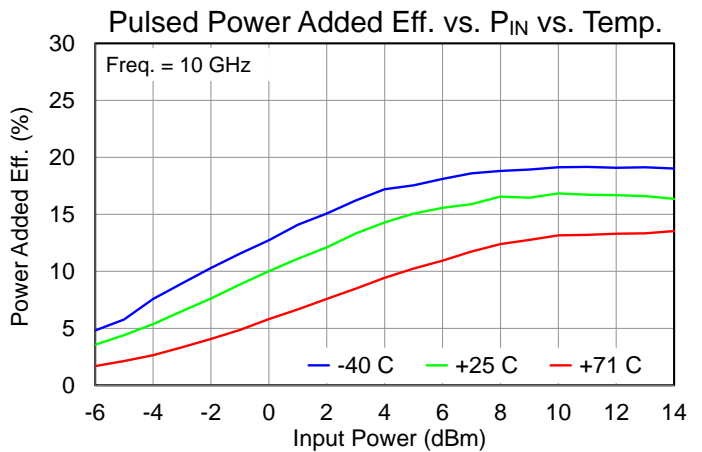
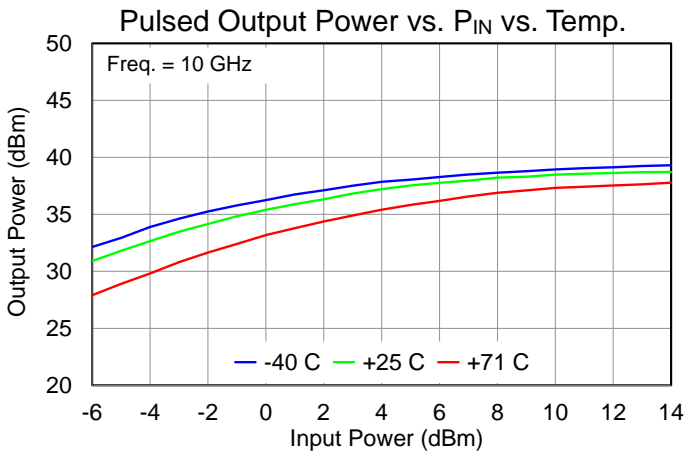
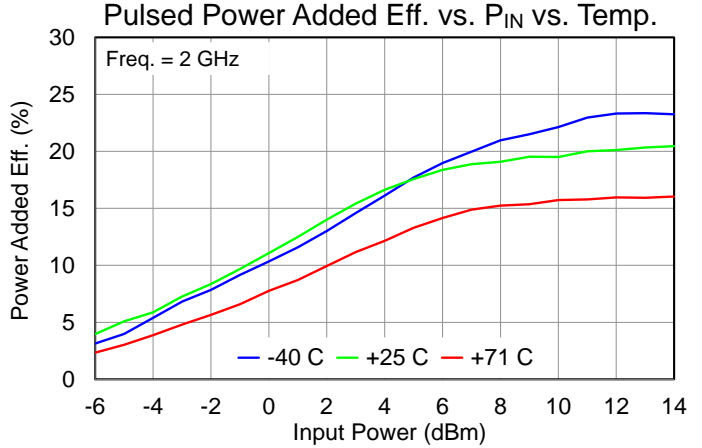
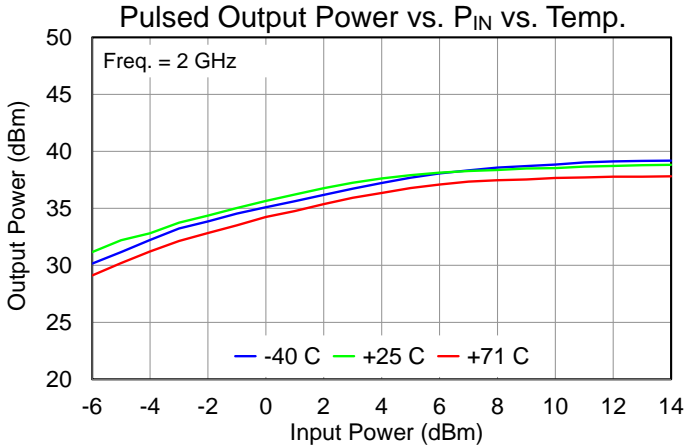

Typical Performance – Harmonics

Test conditions unless otherwise noted: $V_D = 18\text{ V}$, $I_{DQ} = 4\text{ A}$, $T_{CLAMP} = 25\text{ °C}$, CW Operation. $P_{IN} = 14\text{ dBm}$

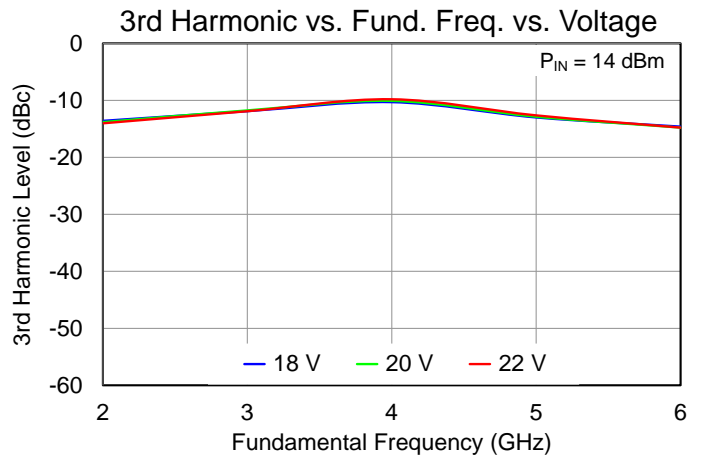
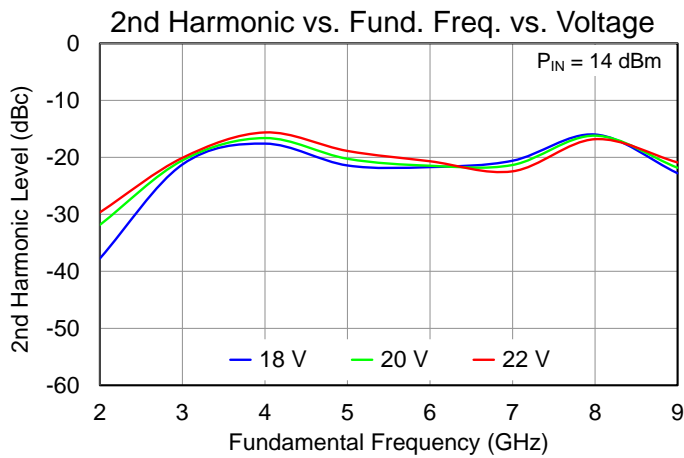
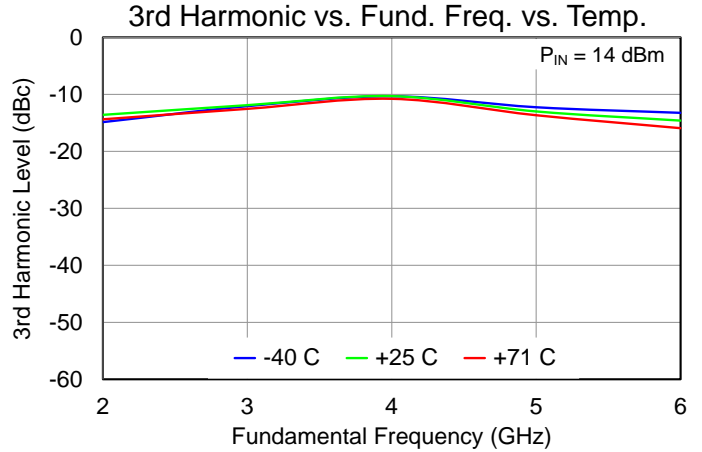
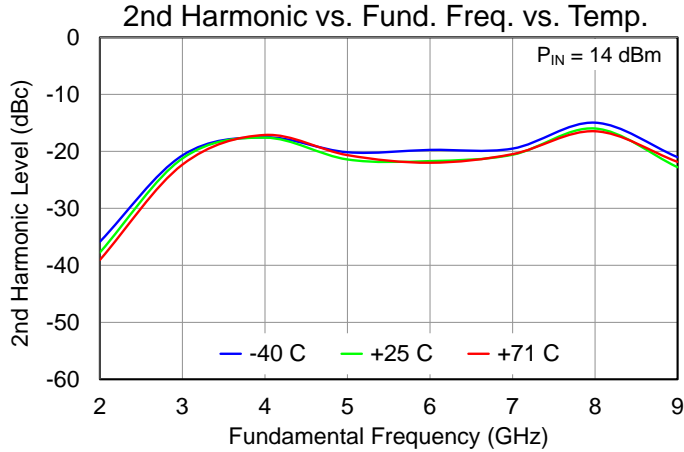

Typical Performance – Small Signal (CW)

Test conditions unless otherwise noted: $V_D = 18\text{ V}$, $I_{DQ} = 4\text{ A}$, $T_{CLAMP} = 25\text{ }^\circ\text{C}$, CW Operation

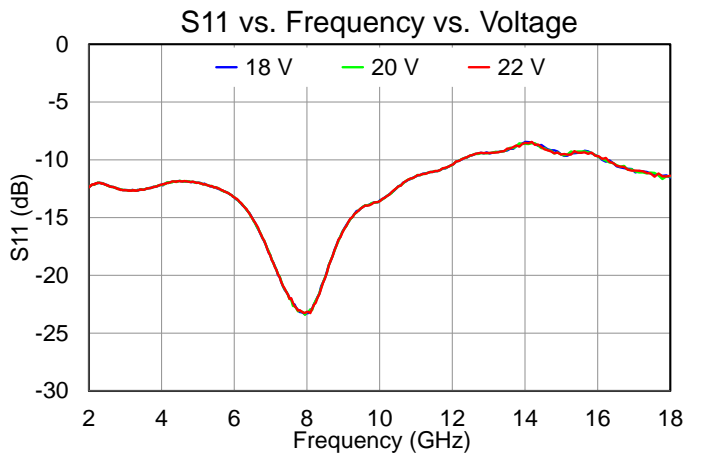
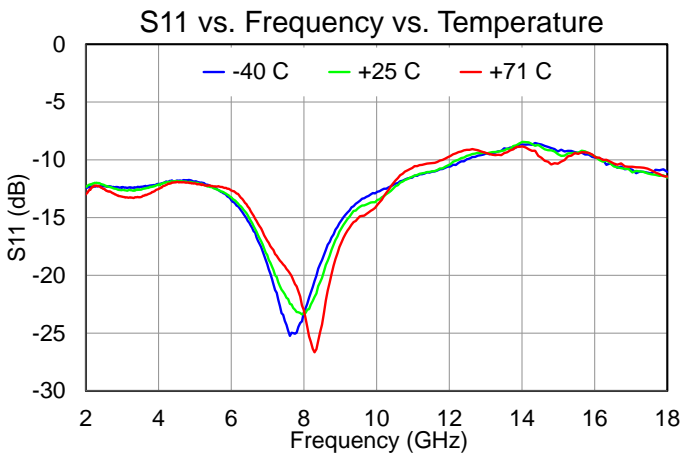
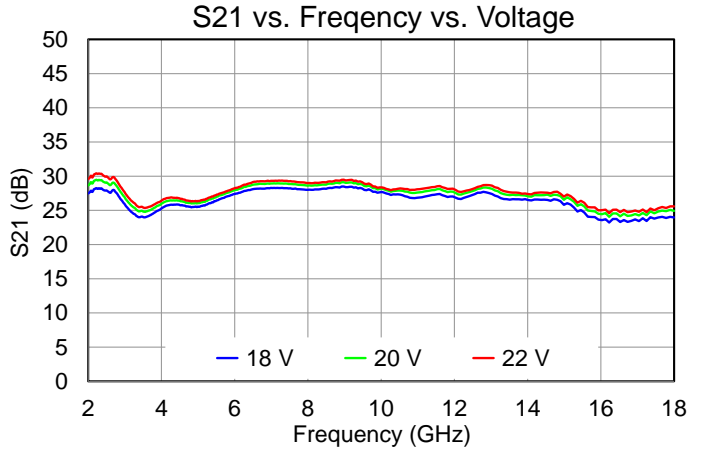
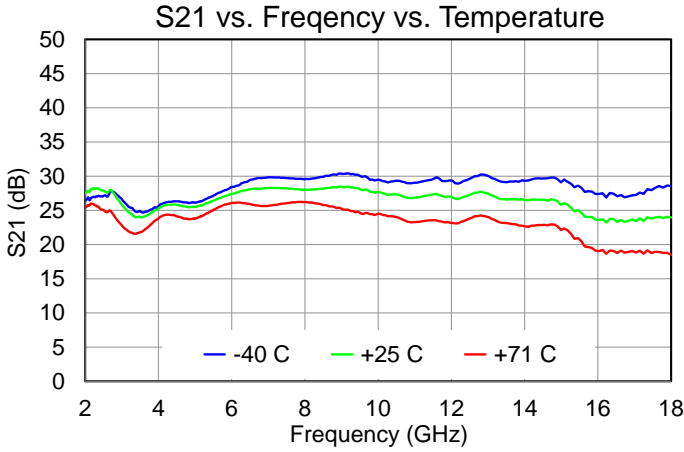

Typical Performance – Reliability

Test conditions unless otherwise noted: $V_D = 18\text{ V}$, $I_{DQ} = 4\text{ A}$, $T_{CLAMP} = \text{as shown}$, CW Operation, $P_{IN} = 14\text{ dBm}$

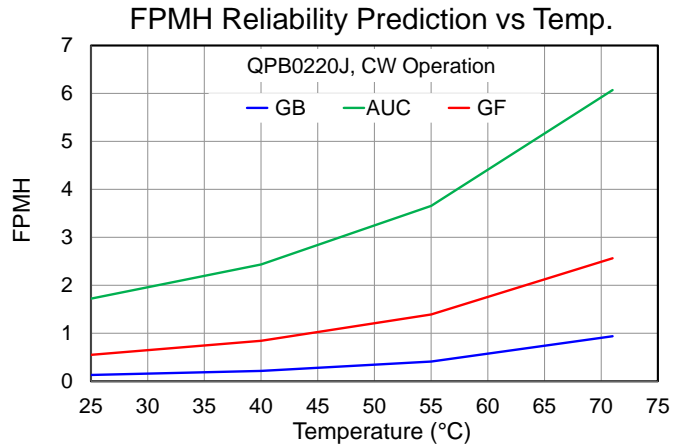
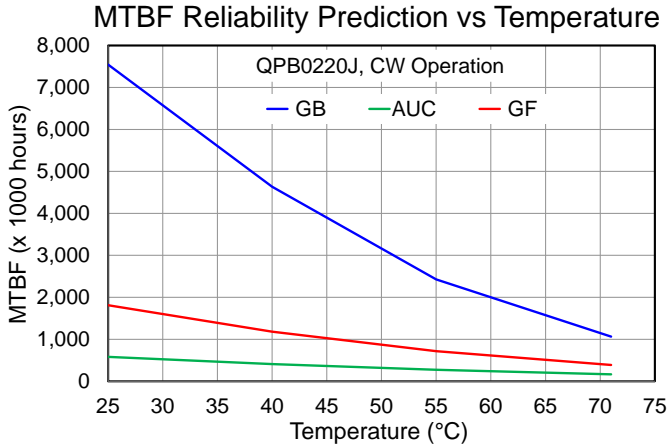

Block Diagram

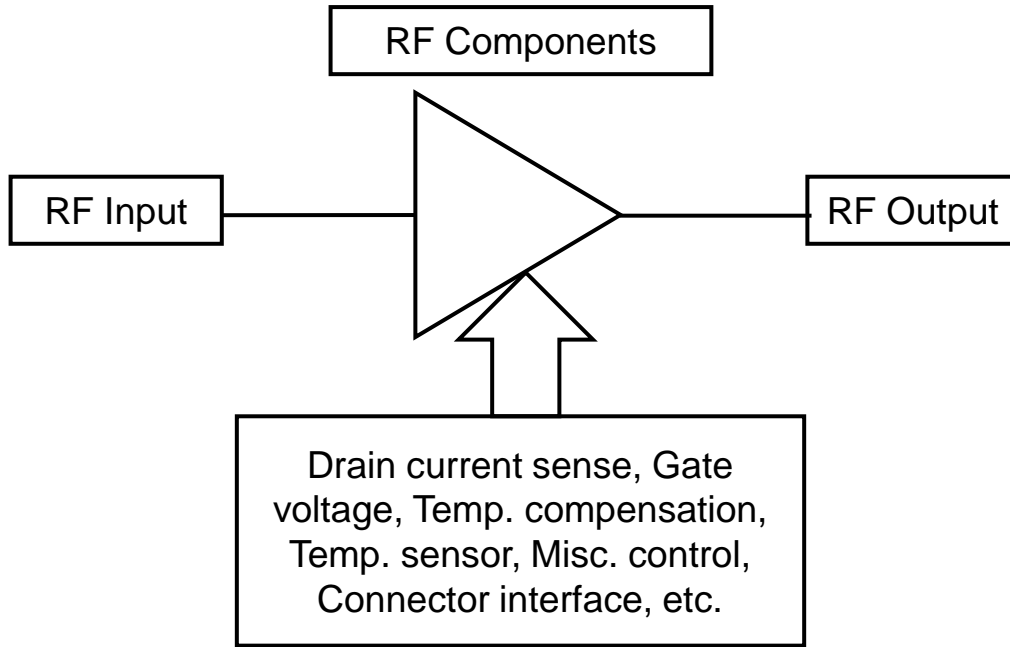

Pin No.	Label	Description
RF Input	J1	SMA (F) Coaxial RF Input
RF Output	J2	SMA (F) Coaxial RF Input
Power I/O	J3	M83513/04-D03N D-Sub connector

Mechanical Information – Amplifier Outline Drawing and Interface Connector

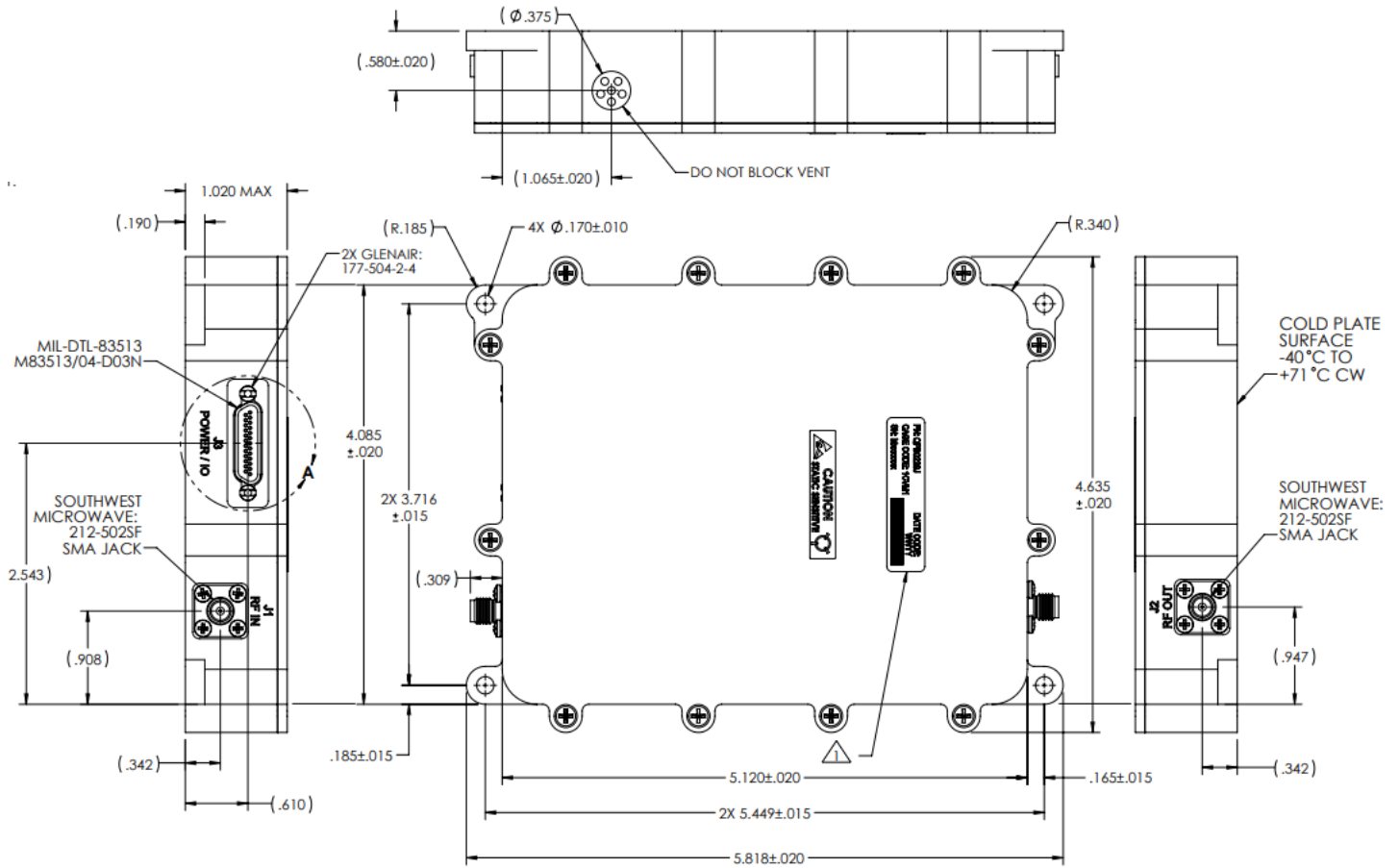

Dimensions are in INCHES

NOTES: UNLESS OTHERWISE SPECIFIED

- 1 LABEL LOCATION:
SN: * * * * *
BATCH I.D.
WORK WEEK
CALENDAR YEAR
MANUFACTURER
- 2 FOR J3 PIN ASSIGNMENT SEE TABLE 1.
- 3. WEIGHT: 3.9 LBS. MAX.

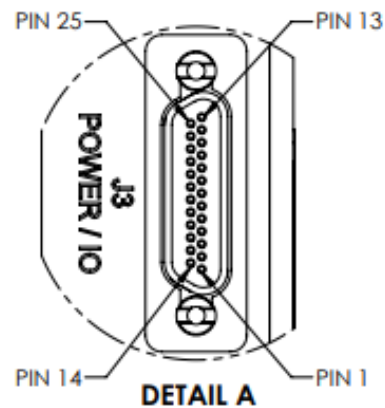
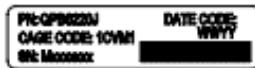

Mechanical Information – Interface Connector Pinout Function and Description

J1 PIN CONFIGURATION AND FUNCTION DESCRIPTION		
PIN NO.	FUNCTION	DESCRIPTION
1	SDA	I2C bus used to program amplifier for operation. Please contact Qorvo applications engineering for further information.
2	RESET	I2C bus used to program amplifier for operation. Please contact Qorvo applications engineering for further information.
3	GND	Connect to logic/power ground.
4	ID_PA3	Voltage output on this pin follows .5V/A times the current flowing through gain stage 3 of the amplifier. Can be used for diagnostics / status of MMIC; otherwise leave open."
5	ID_PA1	Voltage output on this pin follows .5V/A times the current flowing through gain stage 1 of the amplifier. Can be used for diagnostics / status of MMIC; otherwise leave open.
6	ID_PA2	Voltage output on this pin follows .5V/A times the current flowing through gain stage 2 of the amplifier. Can be used for diagnostics / status of MMIC; otherwise leave open.
7	Spare	Spare
8	GND	Connect to logic/power ground.
9	GATE_EN	5V logic command bit for setting the gain stages to low power mode operation. 0V puts the unit into a low-power state while 5V will allow normal operation. In the absence of an external logic signal (open), the amplifier will power on with the application of the supply voltage.
10	GND	Connect to logic/power ground.
11	GND	Connect to logic/power ground.
12	V_Supply	Primary supply voltage powering the amplifier. Please see operational data for details.
13	V_Supply	Primary supply voltage powering the amplifier. Please see operational data for details.
14	SCL	I2C bus used to program amplifier for operation. Please contact Qorvo applications engineering for further information.
15	GND	Connect to logic/power ground.
16	Spare	Spare
17	VTEMP_OUT	Connects to Texas Instruments LMT87 temperature sensor output. Can be used to monitor reference temperature of amplifier. For relationship between output voltage and temperature, please see the LMT87 datasheet.
18	Spare	Spare
19	Spare	Spare
20	GND	Connect to logic/power ground.
21	DRAIN_EN	5V logic command bit to turn on/off the drain voltage leading to each channel of the amplifier. 0V puts the unit into a low-power state while 5V will allow normal operation. In the absence of an external logic signal (open), the amplifier will power on with the application of the supply voltage.
22	GND	Connect to logic/power ground.
23	GND	Connect to logic/power ground.
24	V_Supply	Primary supply voltage powering the amplifier. Please see operational data for details.
25	V_Supply	Primary supply voltage powering the amplifier. Please see operational data for details.