

### Product Overview

Qorvo’s QPC1006 is a Single-Pole, Triple-Throw (SP3T) switch fabricated on Qorvo’s QGaN25 0.25um GaN on SiC production process.

Operating from 0.15 to 2.8 GHz, the QPC1006 typically supports 50 W input power handling at control voltages of 0/–40 V for both CW and pulsed RF operations. This switch maintains low insertion loss less than 1.0 dB and greater than 30 dB isolation, making it ideal for high power switching applications across both defense and commercial platforms.

QPC1006 is offered in a 4 x 4 mm plastic overmolded QFN package.

Lead-free and RoHS compliant

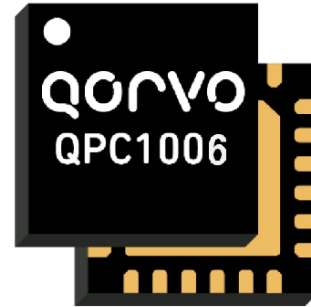

4mm x 4mm 24 Lead OVM QFN

### Key Features

- SP3T
- Frequency Range: 0.15 to 2.8 GHz
- Input Power: 50 W
- Insertion Loss: < 1.0 dB
- Isolation: >30 dB Typical
- Switching Speed: 50 ns
- Control Voltages: 0 V/–40 V
- Package Dimensions: 4 x 4 x 0.85 mm

*Performance is typical across frequency. Please reference electrical specification table and data plots for more details.*

### Functional Block Diagram

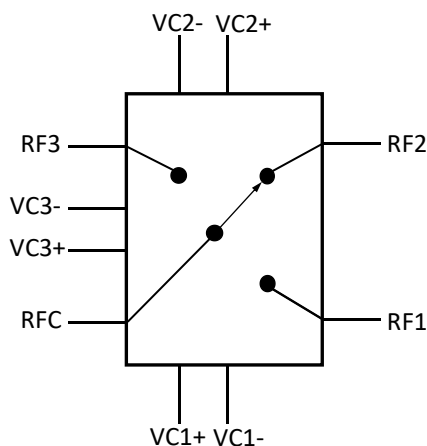

### Applications

- Commercial and Military Radar
- Communications
- Electronic Warfare
- Test Instrumentation
- General Purpose

### Ordering Information

Part No.	Description
QPC1006	0.15–2.8 GHz High Power GaN SP3T Switch
QPC1006EVB	Evaluation Board

## Absolute Maximum Ratings

Parameter	Rating
Control Voltage ( $V_c$ )	-50 V
Control Current ( $I_c$ )	3 mA
Power Dissipation <sup>(1)</sup>	14 W
RF Input Power, CW, 50 $\Omega$ , T = 25 °C	60 W
Mounting Temperature (30 sec)	260 °C
Storage Temperature	-40 to 150 °C

Exceeding any one or a combination of the Absolute Maximum Rating conditions may cause permanent damage to the device. Extended application of Absolute Maximum Rating conditions to the device may reduce device reliability.

Notes:

- 1) This is a total loss of which 4 W is mismatched loss and 3 W is dissipated in the passive structures.

## Recommended Operating Conditions

Parameter	Min	Typ.	Max	Units
$V_{C1+}/V_{C1-}$		0/-40		V
$V_{C2+}/V_{C2-}$		-40/0		V
$V_{C3+}/V_{C3-}$		-40/0		V
Temperature Range	-40	+25	+85	°C

Electrical specifications are measured at specified test conditions. Specifications are not guaranteed over all recommended operating conditions.

## Thermal and Reliability Information

Parameter	Test Conditions	Value	Units
Thermal Resistance ( $\theta_{JC}$ ) <sup>(1,2)</sup>	$T_{BASE} = 85$ °C, $V_{C1+} = 0$ V, $V_{C2+} = -40$ V,, $V_{C3+} = -40$ V	5.52	°C/W
Channel Temperature ( $T_{CH}$ ) <sup>(1,2)</sup>	Freq. = 2.8 GHz, $P_{IN} = 50$ W, $P_{DISS}$ <sup>(3)</sup> = 5.8 W, CW	117	°C

Notes:

1. Measured to the back of the package.
2. Refer to the following document: [GaN Device Channel Temperature, Thermal Resistance, and Reliability Estimates](#)
3. This is a total  $P_{DISS}$  in the FETs.

## Electrical Specifications

Test conditions unless otherwise noted: 25 °C,  $V_{C1+}/V_{C1-} = 0\text{V}/-40\text{V}$ ,  $V_{C2+}/V_{C2-} = -40\text{V}/0\text{V}$ ,  $V_{C3+}/V_{C3-} = -40\text{V}/0\text{V}$ .  
See Logic table on page 12.

Parameter	Min	Typ.	Max	Units
Operational Frequency Range	0.15	–	2.8	GHz
Insertion Loss (On-State)	Frequency = 0.15 GHz	–	0.30	dB
	Frequency = 1.0 GHz	–	0.43	
	Frequency = 2.8 GHz	–	1.0	
Input Return Loss (On-State) Common Port RL	Frequency = 0.15 GHz	–	35	dB
	Frequency = 1.0 GHz	–	33	
	Frequency = 2.8 GHz	–	12.5	
Output Return Loss (On-State) Switched Port RL	Frequency = 0.15 GHz	–	34.5	dB
	Frequency = 1.0 GHz	–	32	
	Frequency = 2.8 GHz	–	13	
Isolation (Off-State)	Frequency = 0.15 GHz	–	57	dB
	Frequency = 1.0 GHz	–	40	
	Frequency = 2.8 GHz	–	30	
Output Return Loss Isolated Port	Frequency = 0.15 GHz	–	2.3	dB
	Frequency = 1.0 GHz	–	2.4	
	Frequency = 2.8 GHz	–	2.0	
Insertion Loss @ $P_{IN} = 47\text{ dBm}$ (Pulsed RF) $PW = 100\mu\text{s}$ ; $DC = 10\%$	Frequency = 0.15 GHz	–	0.32	dB
	Frequency = 1.0 GHz	–	0.45	
	Frequency = 2.8 GHz	–	1.0	
Insertion Loss @ $P_{IN} = 47\text{ dBm}$ (CW)	Frequency = 0.15 GHz	–	0.37	dB
	Frequency = 1.0 GHz	–	0.55	
	Frequency = 2.8 GHz	–	1.2	
Input Power ( $P_{0.1dB}$ )	–	47	–	dBm
Control Voltage		-40	-50	V
Total Supply Current		<3		mA
Switching Speed		50		nS
Insertion Loss Temperature Coefficient	–	-0.0015	–	dB/°C

Performance Plots – Small Signal

Notes: RFC = Port1; RF1 = Port 2; RF2 = Port 3; RF3 = Port4. See Logic table on Page 12 for Voltage controls

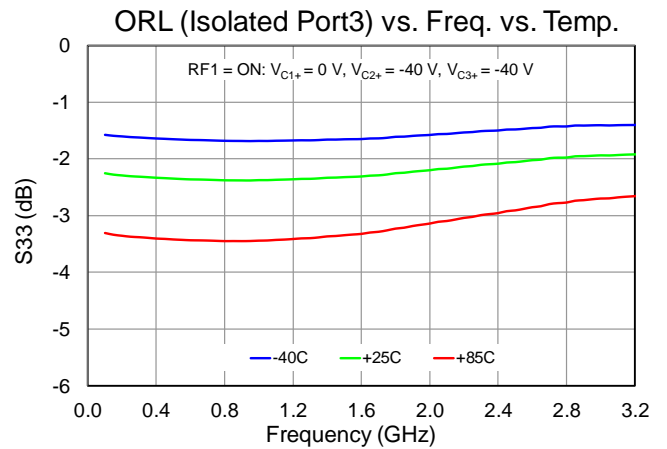
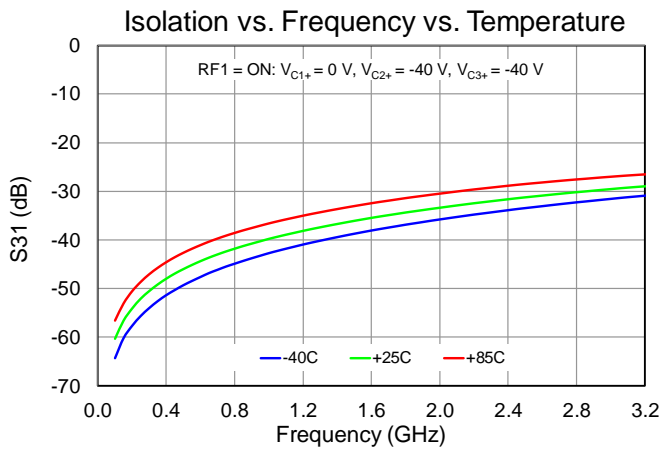
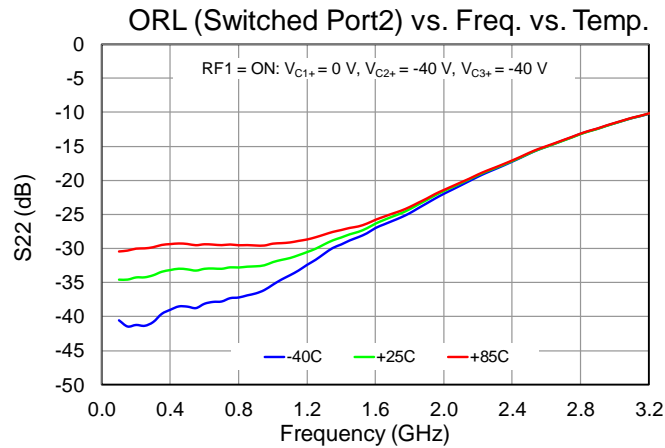
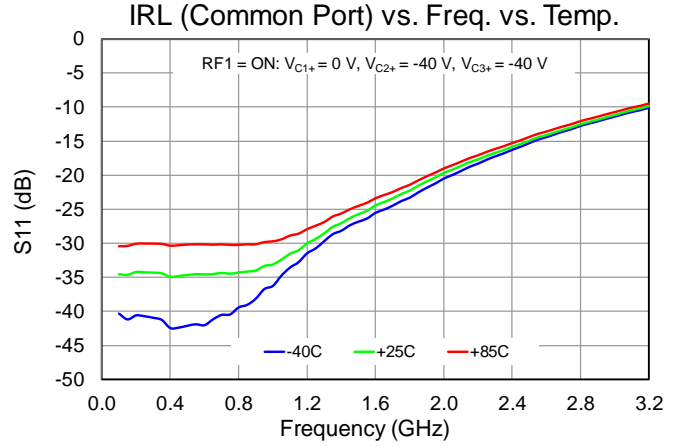
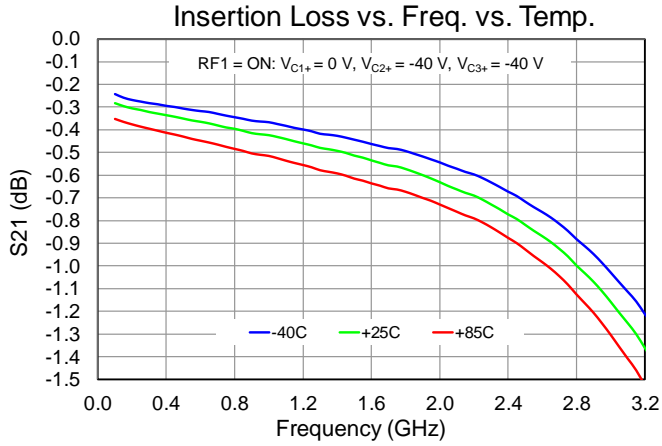

Performance Plots – Small Signal

Notes: RFC = Port1; RF1 = Port 2; RF2 = Port 3; RF3 = Port4. See Logic table on Page 12 for Voltage controls

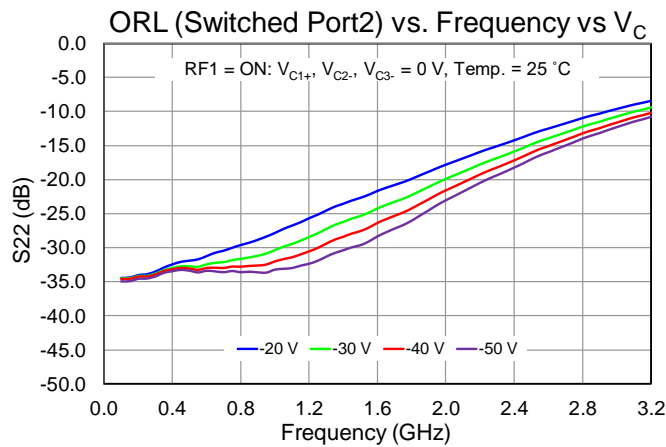
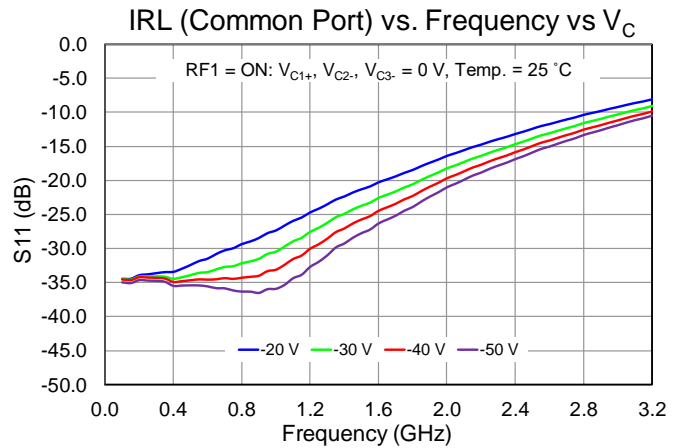
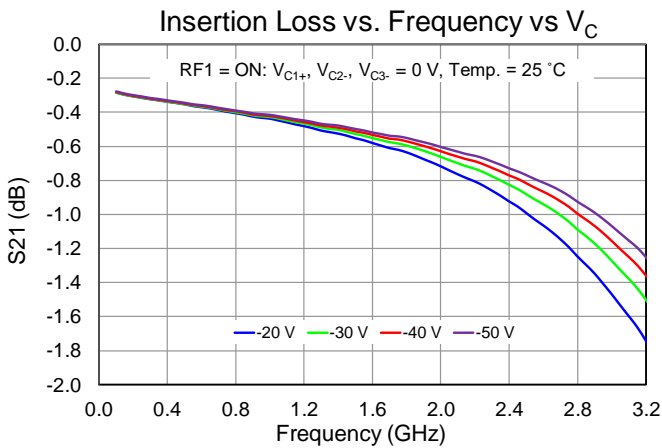
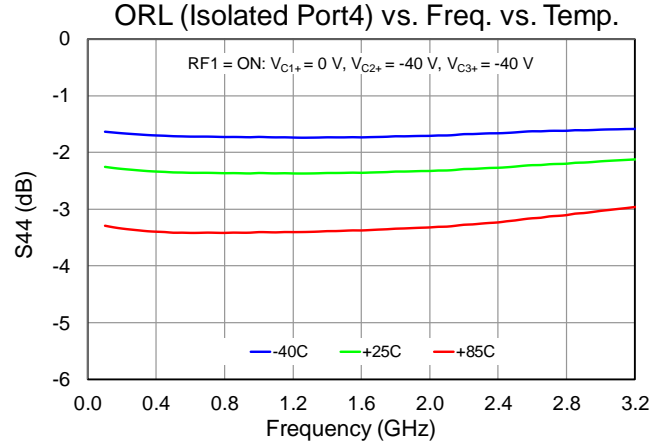
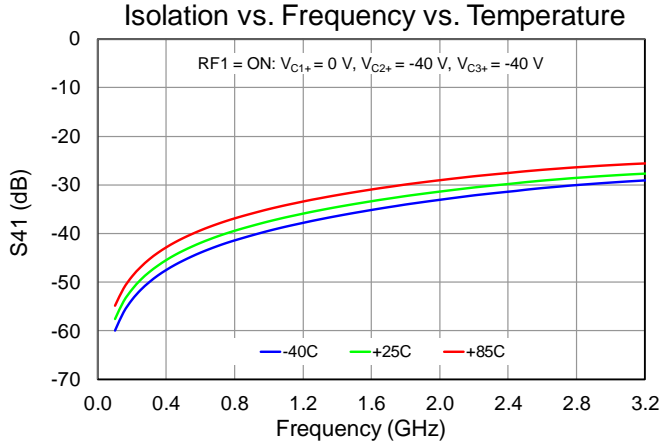

Performance Plots – Small Signal

Notes: RFC = Port1; RF1 = Port 2; RF2 = Port 3; RF3 = Port4. See Logic table on Page 12 for Voltage controls

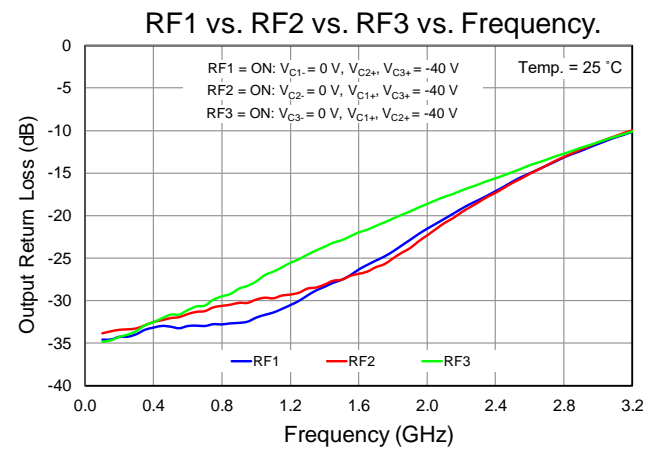
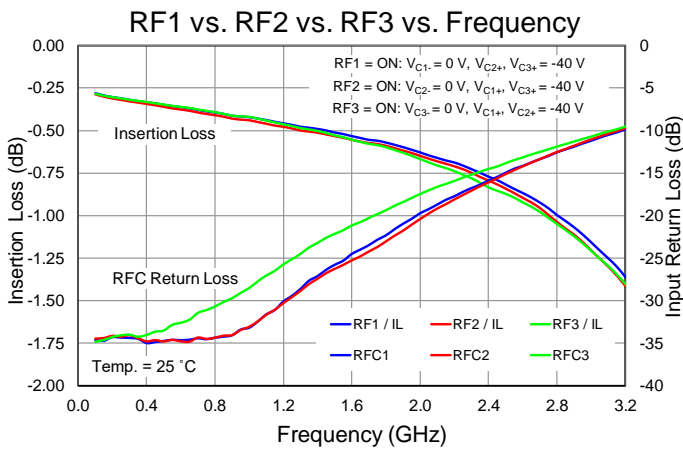
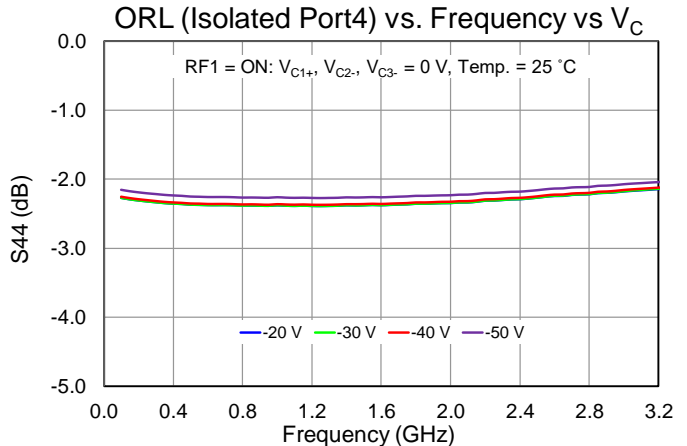
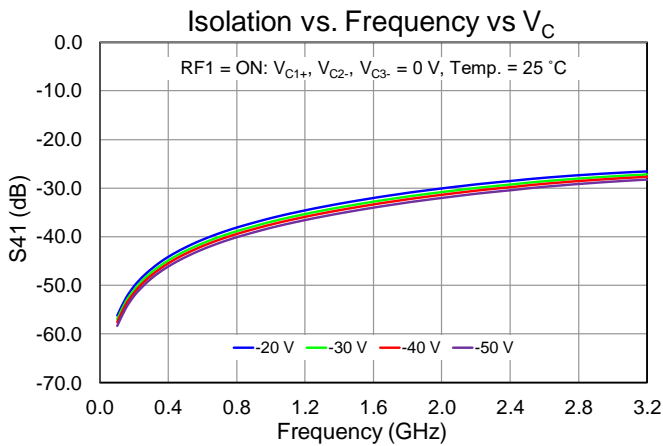
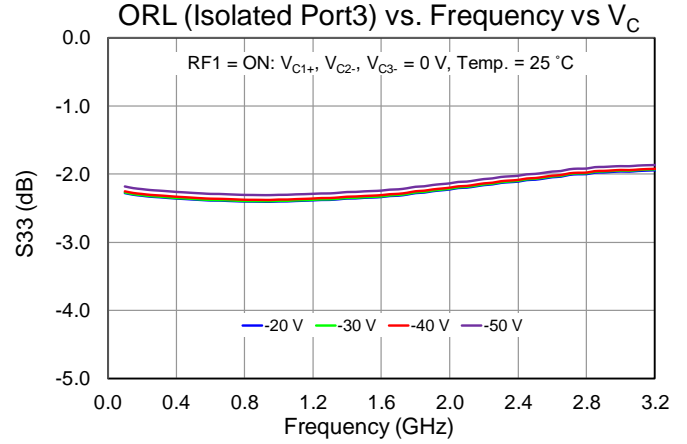
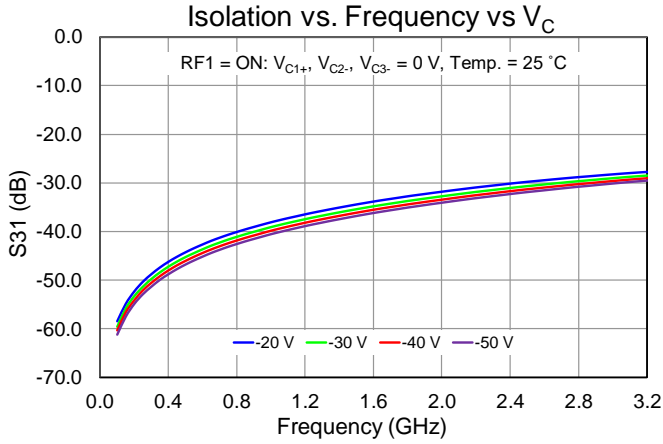

## Performance Plots – Compression (Pulsed)

Notes: RFC = Port1; RF1 = Port 2; RF2 = Port 3; RF3 = Port4. See Logic table on Page 12 for Voltage controls

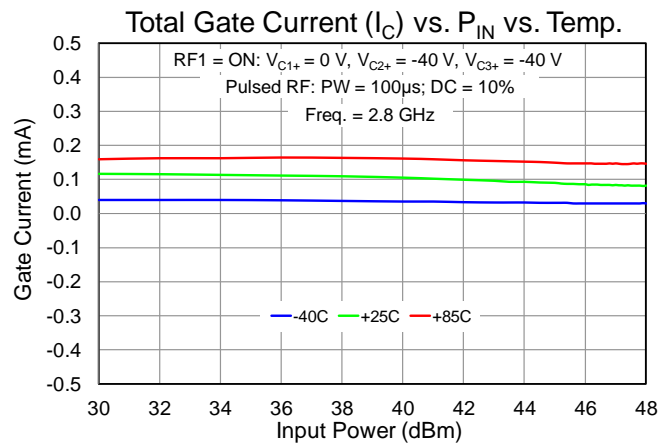
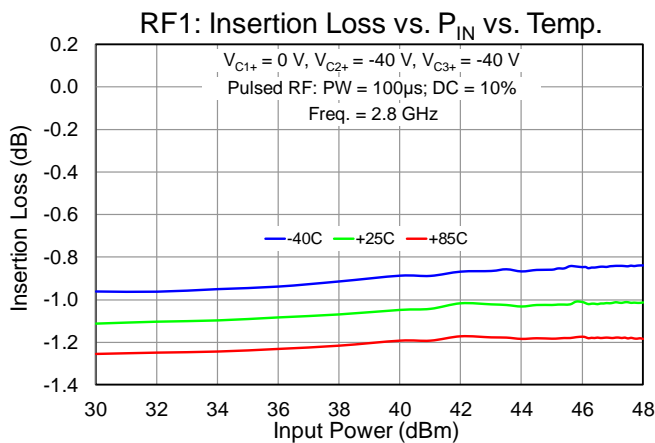
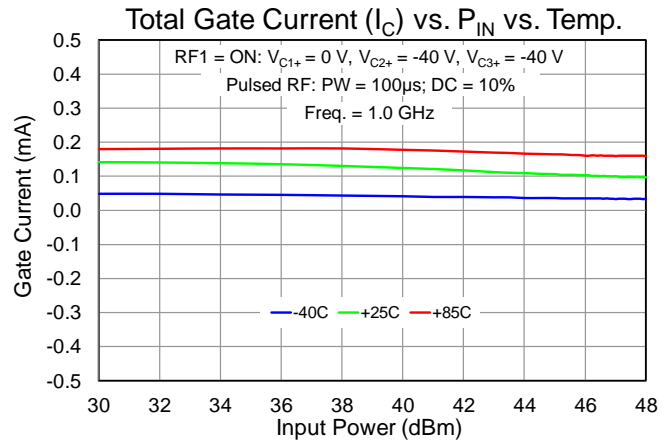
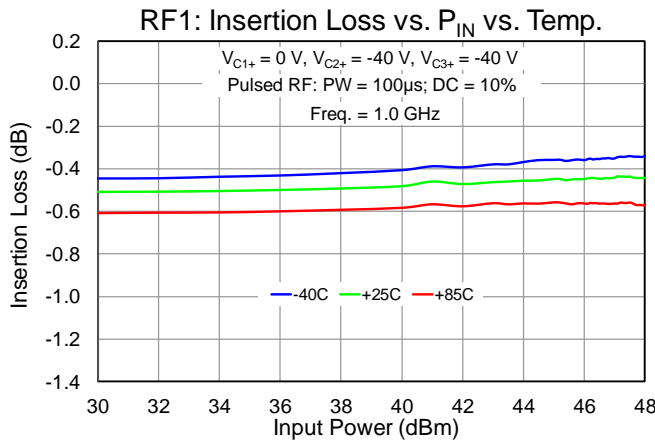
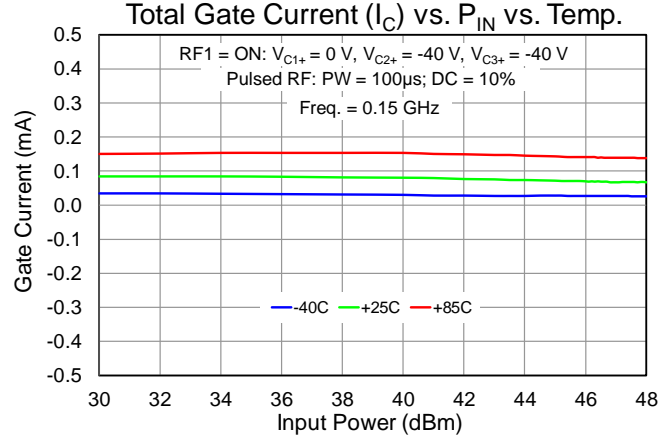
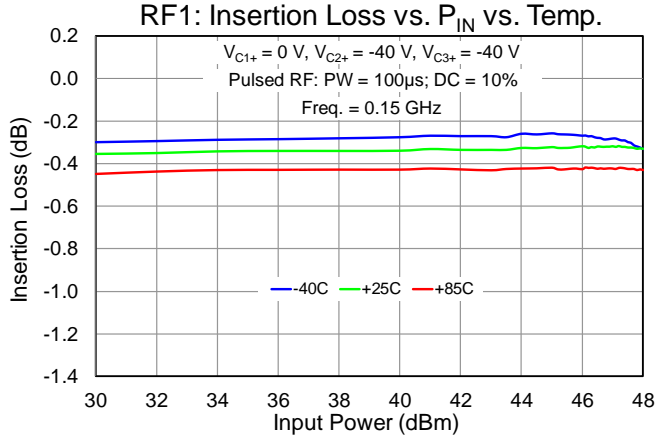

## Performance Plots – Compression (Pulsed)

Notes: RFC = Port1; RF1 = Port 2; RF2 = Port 3; RF3 = Port4. See Logic table on Page 12 for Voltage controls

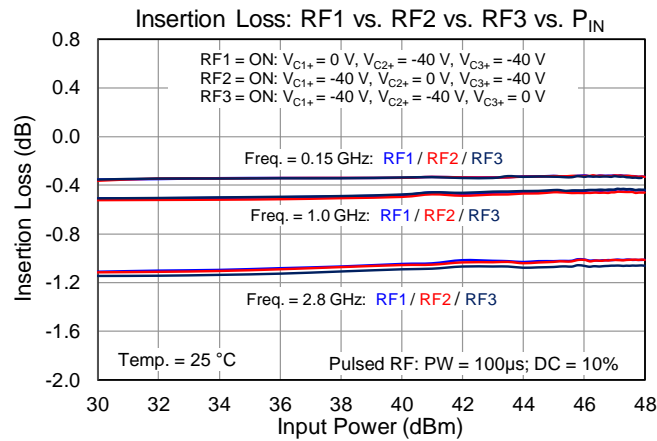
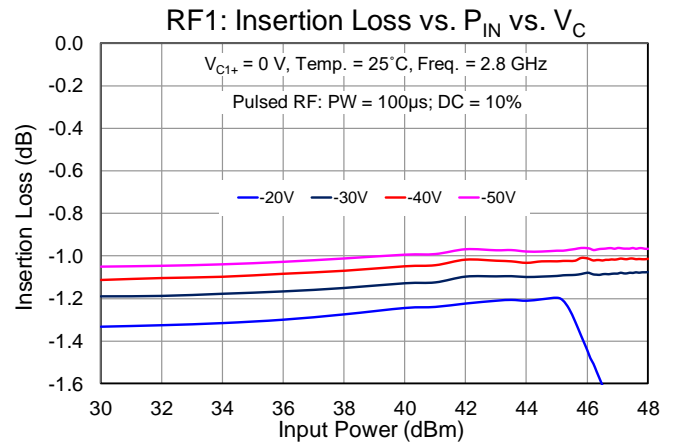
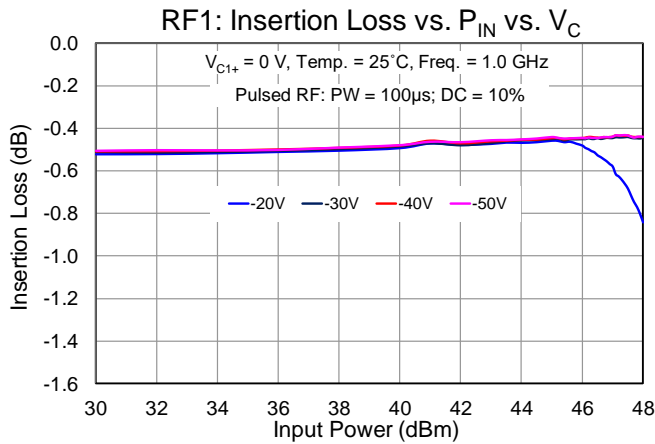
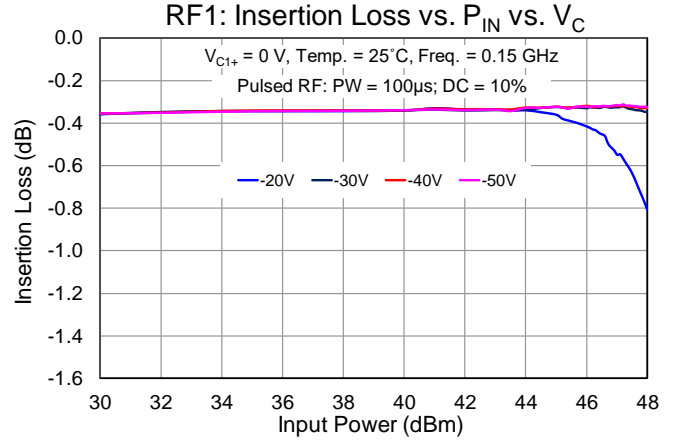
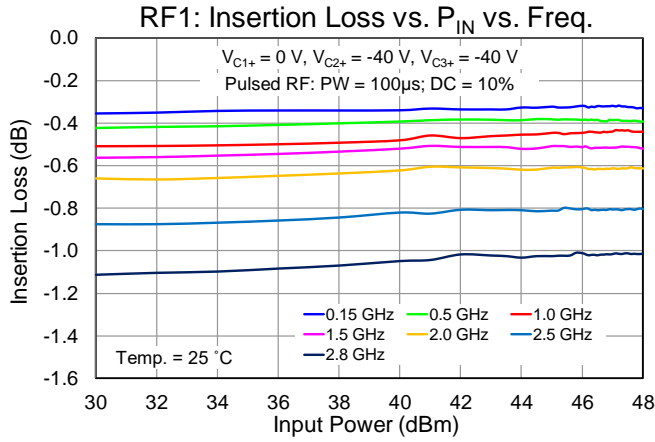



## Performance Plots – Compression (CW)

Notes: RFC = Port1; RF1 = Port 2; RF2 = Port 3; RF3 = Port4. See Logic table on Page 12 for Voltage controls

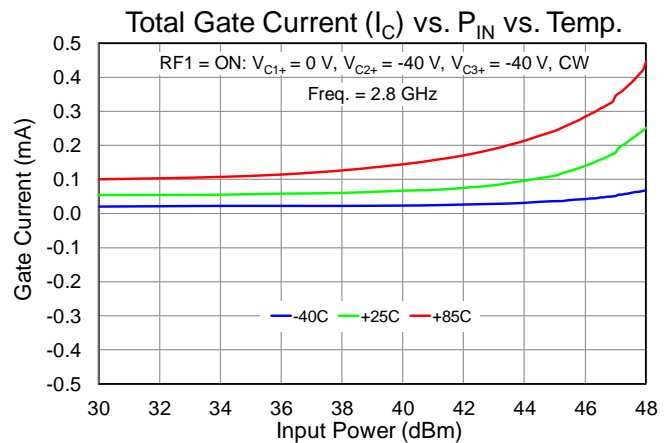
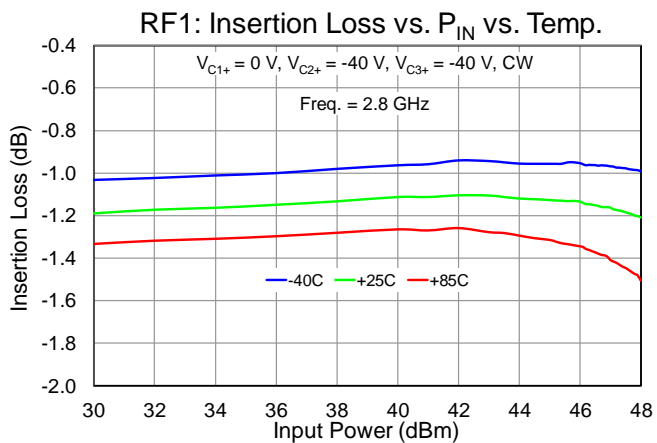
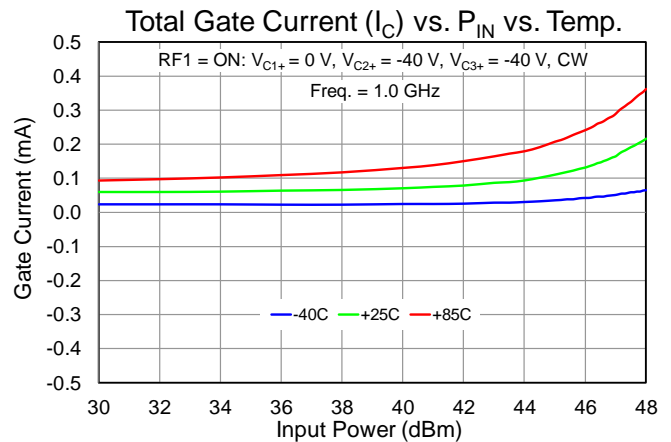
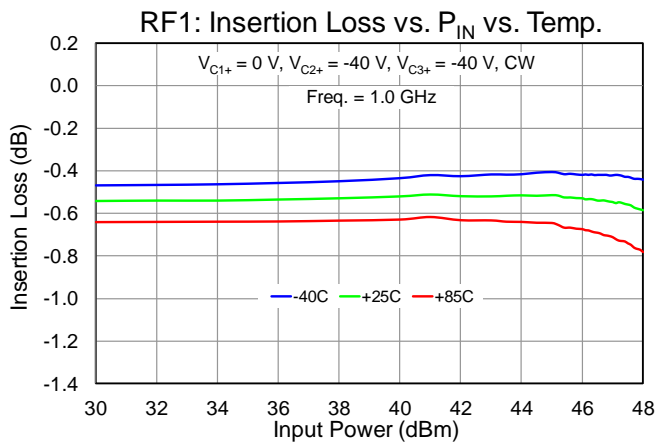
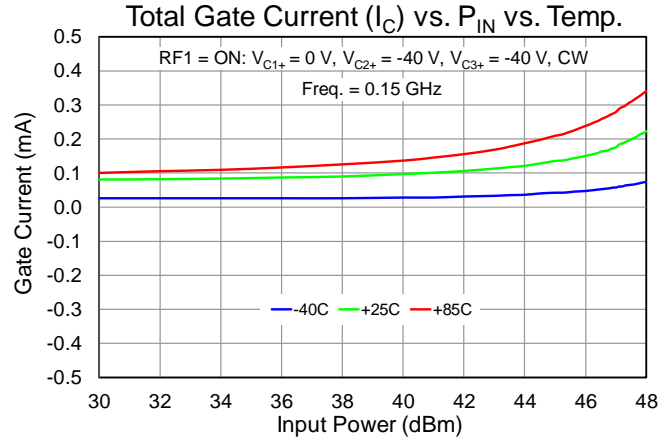
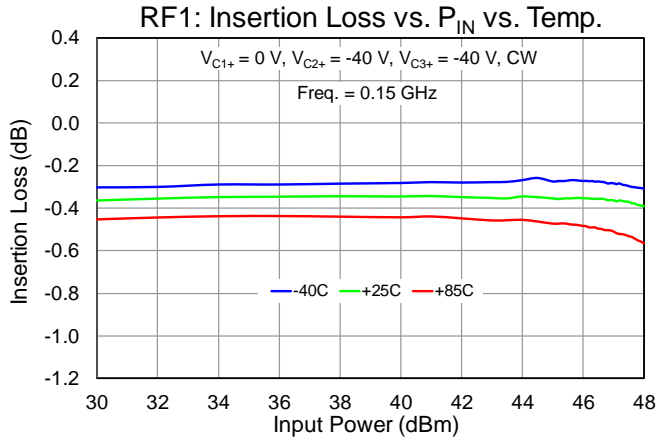

## Performance Plots – Compression (CW)

Notes: RFC = Port1; RF1 = Port 2; RF2 = Port 3; RF3 = Port4. See Logic table on Page 12 for Voltage controls

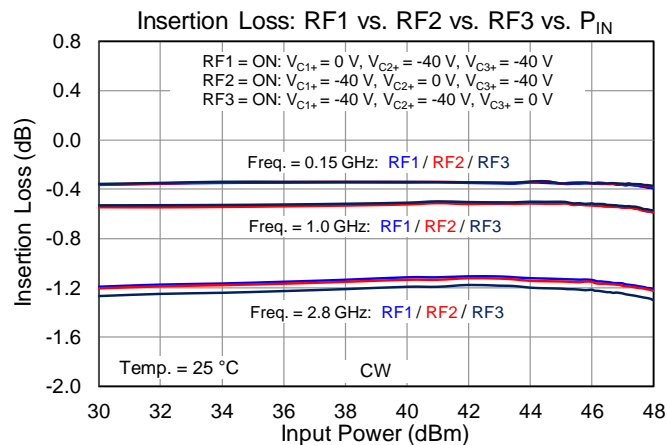
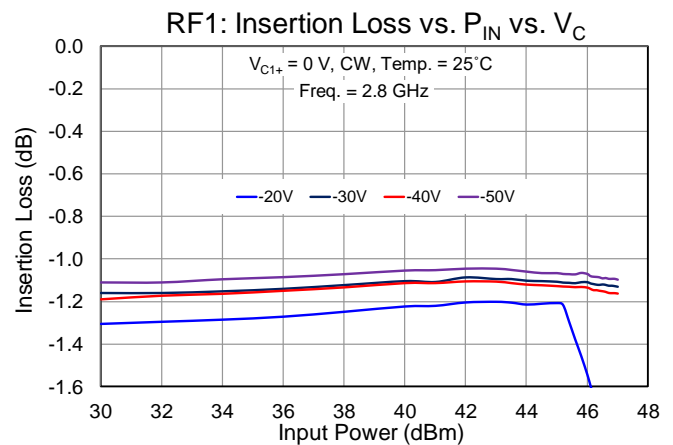
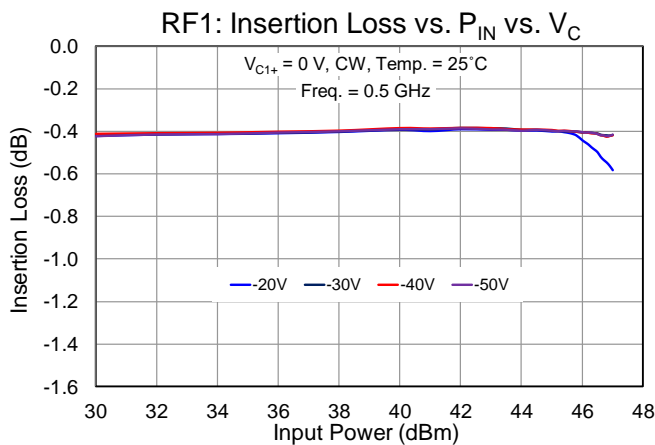
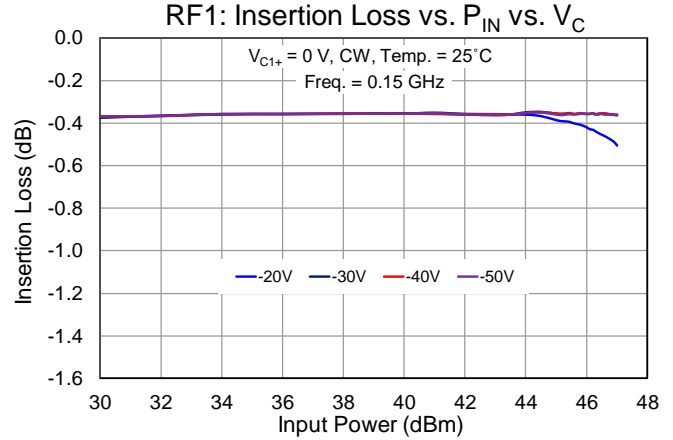
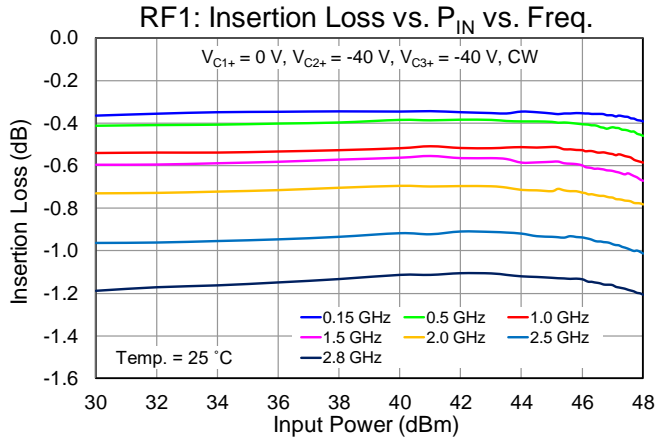

Performance Plots – Linearity

Notes: RFC = Port1; RF1 = Port 2; RF2 = Port 3; RF3 = Port4. See Logic table on Page 12 for Voltage controls

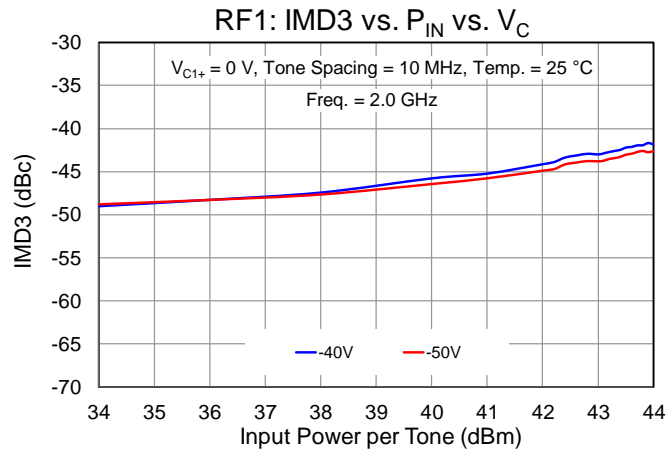
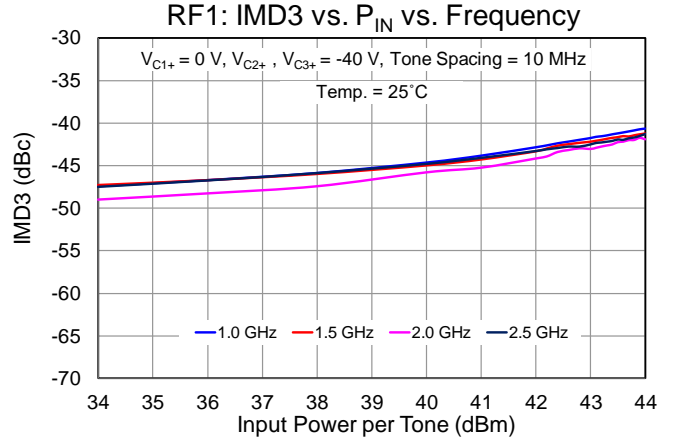
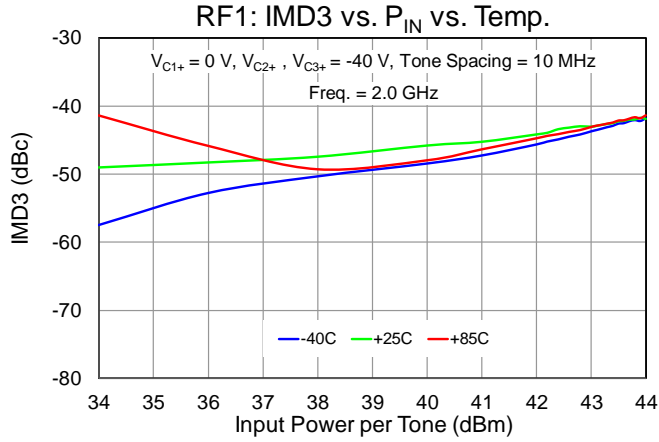

## Application Circuit

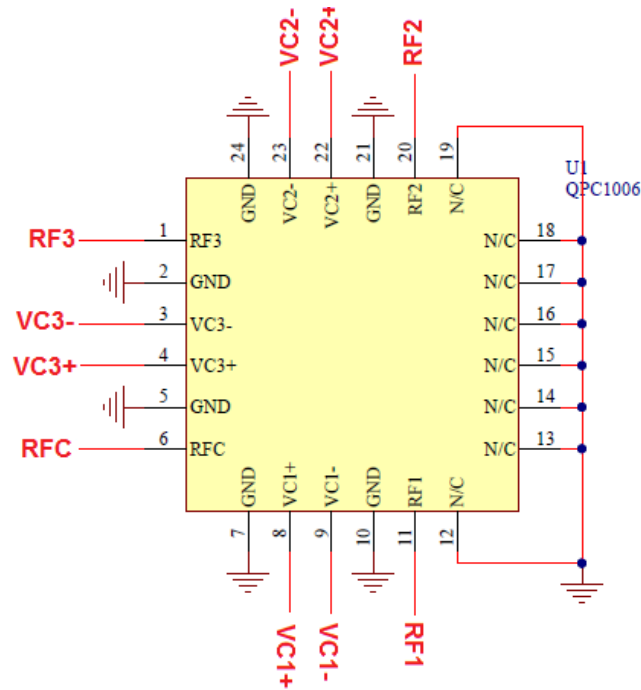

**Notes:**

1. This switch can be configured as a Single Pole, Single Throw (SPST) by terminating two unused RF switched ports with a 50 Ohm load.
2. External components are not required.

### Bias Up Procedure

1.  $V_{C1+}$  or  $V_{C2+}$  or  $V_{C3+}$  set to 0 V (see Logic Table for RF Path)
2.  $V_{C1-}$  or  $V_{C2-}$  or  $V_{C3-}$  set to -40 V (see Logic Table for RF Path)
3. Apply RF signal to RF Input

### Bias Up Down

1. Turn off RF supply
2. Turn  $V_{C1-}$  or  $V_{C2-}$  or  $V_{C3-}$  to 0 V
3. Turn  $V_{C1+}$  or  $V_{C2+}$  or  $V_{C3+}$  to 0 V

### Logic Table (SP3T Truth Table)

RF Path	State	$V_{C1+}$	$V_{C1-}$	$V_{C2+}$	$V_{C2-}$	$V_{C3+}$	$V_{C3-}$
RFC to RF1 ON	On-State (Insertion Loss), RF2 & RF3 = OFF	H	L	L	H	L	H
RFC to RF2 ON	On-State (Insertion Loss), RF1 & RF3 = OFF	L	H	H	L	L	H
RFC to RF3 ON	On-State (Insertion Loss), RF1 & RF2 = OFF	L	H	L	H	H	L

- VC High (H) = 0 V
- VC Low (L) = -20, -30, -40 or -50 V

**Evaluation Board (EVB) Assembly Layout.**

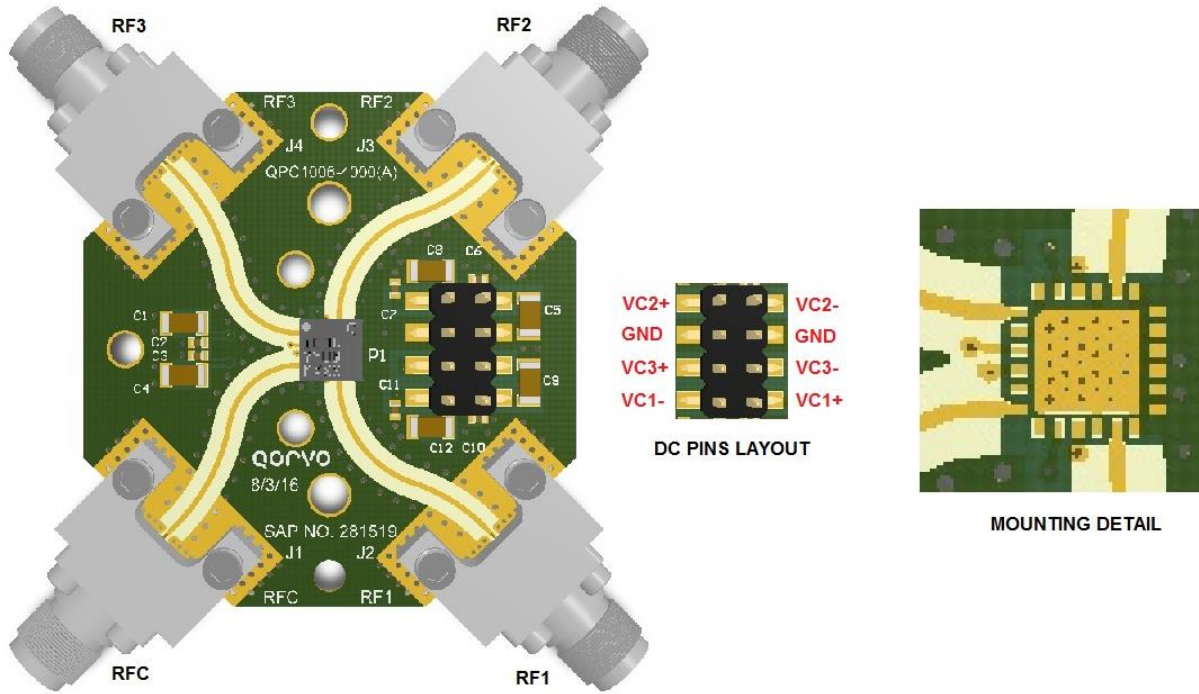

**Notes:**

1. This switch can be configured as a Single Pole, Single Throw (SPST) by terminating one unused RF switched port with a 50 Ohm load.
2. See Logic Table on page 12 for biasing the voltage controls.
3. External components are not required

## Mechanical Information

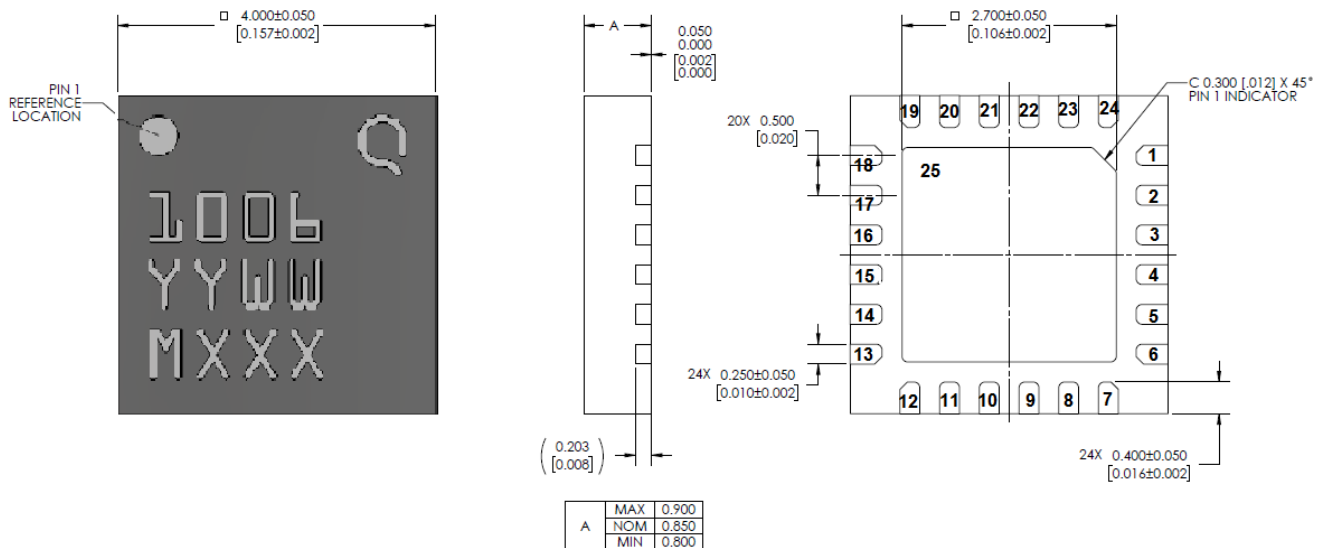

Units: millimeters

Tolerances: unless specified

x.xx = ± 0.25

x.xxx = ± 0.100

Materials:

Base: Cu Alloy

Packaged Exposed Metallization is gold plated

Marking:

QPC1006: Part number

YY: Part Assembly year

WW: Part Assembly week

MXXX: Batch ID

## Pin Description

Pad No.	Symbol	Description
1	RF3	RF switched port 4; matched to 50 Ω; DC coupled
2, 5, 7, 10, 21, 24	GND	Ground. Connected to GND paddle (pin 25); should be grounded on PCB to improve isolation
3	V <sub>C3-</sub>	Control voltage #3; External components are not required
4	V <sub>C3+</sub>	Control voltage #3; External components are not required
6	RFC	RF common port (port1)t; matched to 50 Ω; DC coupled
8	V <sub>C1+</sub>	Control voltage #1; External components are not required
9	V <sub>C1-</sub>	Control voltage #1; External components are not required
11	RF1	RF switched port 2; matched to 50 Ω; DC coupled
12 - 19	N/C	Not connected internally. Recommended to be grounded at EVB level
20	RF2	RF switched port 3; matched to 50 Ω; DC coupled
22	V <sub>C2+</sub>	Control voltage #2; External components are not required
23	V <sub>C2-</sub>	Control voltage #2; External components are not required
25	GND	Backside Paddle. Multiple vias should be employed to minimize inductance and thermal resistance.

**Solderability**

1. Compatible with the latest version of J-STD-020, Lead-free solder, 260° C soldering process.
2. The use of no-clean solder to avoid washing after soldering is recommended.
3. Contact plating: Ni-Pd-Au.

**Recommended Soldering Profile**

