

Product Overview

Qorvo’s QPC2511 is a Single-Pole, Triple-Throw (SP3T) switch fabricated on Qorvo’s QGaN15 0.15um GaN on SiC production process.

The throws are specifically designed for high frequency and RF power (30W) S and X band transmission linear power handling. The remaining throw is a wide-band (11+ GHz) low-pass receive path that can operate linear up to 10 W. This switch maintains low insertion loss (approximately 1.5 dB in X-band), 20 dB isolation, making it ideal for high frequency and RF power switching applications across both defense and commercial platforms.

QPC2511 is offered in a 4 x 4 mm Air Cavity Laminate package.

Lead-free and RoHS compliant.

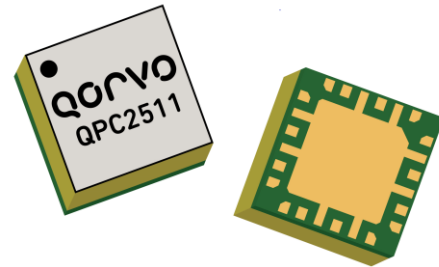

4mm x 4mm 24 Lead Air Cavity Laminate

Key Features

- SP3T
- Frequency Range: 2.0 – 11.0 GHz
- Input Power for Wideband Receive: 10 W
- Input Power for S and X Bands Transmit: 30 W
- Insertion Loss: 1.5 dB Typical
- Isolation: 20 dB Typical
- Switching Speed: < 50 ns
- Control Voltages: 0 V/-30 V
- Package Dimensions: 4 x 4 x 1.48 mm

Performance is typical across frequency. Please reference electrical specification table and data plots for more details.

Functional Block Diagram

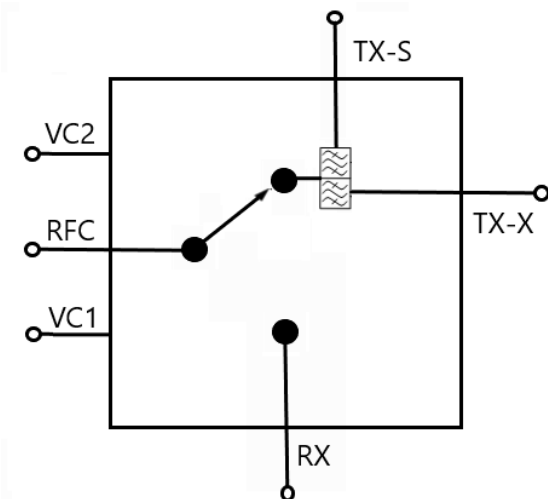

Applications

- Radar
- Communications
- Electronic Warfare

Ordering Information

Part No.	Description
QPC2511SR	100 Piece 7" Reel
QPC2511TR7	500 Piece 7" Reel
QPC2511EVB03	Evaluation Board

Absolute Maximum Ratings

Parameter	Rating
Control Voltage (V_C)	-40 V
Control Current (I_C)	10.0 mA
Power Dissipation, 85 °C	5 W
Input Power (P_{IN}), Pulsed, 3:1 VSWR, RX Mode, $T_{BASE} = 85$ °C	40 dBm
Input Power (P_{IN}), Pulsed, 3:1 VSWR, TX Mode, $T_{BASE} = 85$ °C	45 dBm
Mounting Temperature (30 sec)	260 °C
Storage Temperature	-55 to 150 °C

Exceeding any one or a combination of the Absolute Maximum Rating conditions may cause permanent damage to the device. Extended application of Absolute Maximum Rating conditions to the device may reduce device reliability.

Recommended Operating Conditions

Parameter	Min	Typ.	Max	Units
V_{C1}		0/-30		V
V_{C2}		-30/0		V
Control Voltage Range	-22	-30	-	V
Temperature Range	-40	+25	+85	°C

Electrical specifications are measured at specified test conditions. Specifications are not guaranteed over all recommended operating conditions.

Thermal and Reliability Information

Parameter	Test Conditions	Value	Units
Thermal Resistance (θ_{JC}) ^(1,2)	$T_{BASE} = 85$ °C, $V_{C1} = -30$ V, $V_{C2} = 0$ V, TX Mode Pulsed RF: PW = 300 μ , DC = 25% Freq. = 3.0 GHz, $P_{IN} = 45$ dBm, $P_{DISS} = 1.76$ W	4.45	°C/W
Channel Temperature (T_{CH}) ^(1,2)		93	°C
Thermal Resistance (θ_{JC}) ^(1,2)	$T_{BASE} = 85$ °C, $V_{C1} = -30$ V, $V_{C2} = 0$ V, TX Mode Pulsed RF: PW = 300 μ , DC = 25% Freq. = 10.0 GHz, $P_{IN} = 45$ dBm, $P_{DISS} = 2.0$ W	5.0	°C/W
Channel Temperature (T_{CH}) ^(1,2)		95	°C

Notes:

1. Measured to the back of the package at (85 °C)
2. Refer to the following document: [GaN Device Channel Temperature, Thermal Resistance, and Reliability Estimates](#)

Electrical Specifications (RX Path)

Test conditions unless otherwise noted: 25 °C, $V_{C1} = 0V$, $V_{C2} = -30V$. $P_{IN} = 40\text{ dBm}$, Pulsed RF: $PW = 300\mu\text{s}$; $DC = 25\%$

Parameter	Conditions	Min	Typ.	Max	Units
Operational Frequency Range		2.0	–	11	GHz
Insertion Loss (On-State) $P_{IN} = 40\text{ dBm}$, Pulsed RF: $PW = 300\mu\text{s}$; $DC = 25\%$	Frequency = 3.0 GHz	–	0.73	–	dB
	Frequency = 3.5 GHz	–	0.86	–	
	Frequency = 9.0 GHz	–	1.58	–	
	Frequency = 10.5 GHz	–	1.60	–	
	Frequency = 11.0 GHz	–	1.82	–	
Input Return Loss (On-State) Common Port RL (Small Signal)	Frequency = 3.0 GHz	–	17	–	dB
	Frequency = 3.5 GHz	–	16	–	
	Frequency = 9.0 GHz	–	13	–	
	Frequency = 10.5 GHz	–	24	–	
	Frequency = 11.0 GHz	–	30	–	
Output Return Loss (On-State) Switched Port RL (Small Signal)	Frequency = 3.0 GHz	–	18	–	dB
	Frequency = 3.5 GHz	–	17	–	
	Frequency = 9.0 GHz	–	13	–	
	Frequency = 10.5 GHz	–	25	–	
	Frequency = 11.0 GHz	–	30	–	
Isolation TX-S (Off-State) (Small Signal)	Frequency = 3.0 GHz	–	37	–	dB
	Frequency = 3.5 GHz	–	36	–	
Isolation TX-X (Off-State) (Small Signal)	Frequency = 9.0 GHz	–	23	–	dB
	Frequency = 10.5 GHz	–	20	–	
	Frequency = 11.0 GHz	–	19	–	
Switching Speed			<50		nS
Insertion Loss Temperature Coefficient		–	-0.005	–	dB/°C

Electrical Specifications (TX-X Path)

Test conditions unless otherwise noted: 25 °C, $V_{C1} = -30\text{ V}$, $V_{C2} = 0\text{ V}$. $P_{IN} = 45\text{ dBm}$, Pulsed RF: $PW = 300\mu\text{s}$; $DC = 25\%$

Parameter	Conditions	Min	Typ.	Max	Units
Operational Frequency Range		8.0	–	11.0	GHz
Insertion Loss (On-State) $P_{IN} = 45\text{ dBm}$, Pulsed RF: $PW = 300\mu\text{s}$; $DC = 25\%$	Frequency = 8.0 GHz	–	1.42	–	dB
	Frequency = 9.0 GHz	–	1.43	–	
	Frequency = 10.5 GHz	–	1.57	–	
	Frequency = 11.0 GHz	–	1.67	–	
Input Return Loss (On-State) Common Port RL (Small Signal)	Frequency = 8.0 GHz	–	30	–	dB
	Frequency = 9.0 GHz	–	20	–	
	Frequency = 10.5 GHz	–	18	–	
	Frequency = 11.0 GHz	–	23	–	
Output Return Loss (On-State) Switched Port RL (Small Signal)	Frequency = 8.0 GHz	–	29	–	dB
	Frequency = 9.0 GHz	–	21	–	
	Frequency = 10.5 GHz	–	20	–	
	Frequency = 11.0 GHz	–	34	–	
Isolation TX-S (Off-State) (Small Signal)	Frequency = 9.0 GHz	–	36	–	dB
	Frequency = 10.5 GHz	–	32	–	
	Frequency = 11.0 GHz	–	31	–	
Isolation RX (Off-State) (Small Signal)	Frequency = 3.0 GHz	–	39	–	dB
	Frequency = 3.5 GHz	–	37	–	
	Frequency = 9.0 GHz	–	27	–	
	Frequency = 10.5 GHz	–	25	–	
	Frequency = 11.0 GHz	–	26	–	
Switching Speed			<50		nS
Insertion Loss Temperature Coefficient		–	-0.003	–	dB/°C

Electrical Specifications (TX-S Path)

Test conditions unless otherwise noted: 25 °C, $V_{C1} = -30\text{ V}$, $V_{C2} = 0\text{ V}$. $P_{IN} = 45\text{ dBm}$, Pulsed RF:PW = 300us; DC = 25%

Parameter	Min	Typ.	Max	Units
Operational Frequency Range	2.0	–	4.0	GHz
Insertion Loss (On-State) $P_{IN} = 45\text{ dBm}$, Pulsed RF: PW = 300us; DC = 25%	Frequency = 2.5 GHz	–	1.0	dB
	Frequency = 3.0 GHz	–	1.05	
	Frequency = 3.5 GHz	–	1.14	
	Frequency = 4.0 GHz	–	1.34	
Input Return Loss (On-State) Common Port RL (Small Signal)	Frequency = 2.5 GHz	–	29	dB
	Frequency = 3.0 GHz	–	33	
	Frequency = 3.5 GHz	–	25	
	Frequency = 4.0 GHz	–	21	
Output Return Loss (On-State) Switched Port RL (Small Signal)	Frequency = 2.5 GHz	–	33	dB
	Frequency = 3.0 GHz	–	36	
	Frequency = 3.5 GHz	–	26	
	Frequency = 4.0 GHz	–	23	
Isolation TX-X (Off-State) (Small Signal)	Frequency = 2.5 GHz	–	42	dB
	Frequency = 3.0 GHz	–	38	
	Frequency = 3.5 GHz	–	34	
	Frequency = 4.0 GHz	–	35	
Isolation RX (Off-State) (Small Signal)	Frequency = 3.0 GHz	–	39	dB
	Frequency = 3.5 GHz	–	37	
	Frequency = 9.0 GHz	–	27	
	Frequency = 10.5 GHz	–	25	
	Frequency = 11.0 GHz	–	26	
Switching Speed		< 50		nS
Insertion Loss Temperature Coefficient	–	-0.002	–	dB/°C

Performance Plots – Small Signal (RX)

Notes: RFC = Port1; RF1 = Port 2 = RX; RF2 = Port 3 = TX-X; RF3 = Port4 = TX-S. See Logic table on Page 21 for Voltage controls

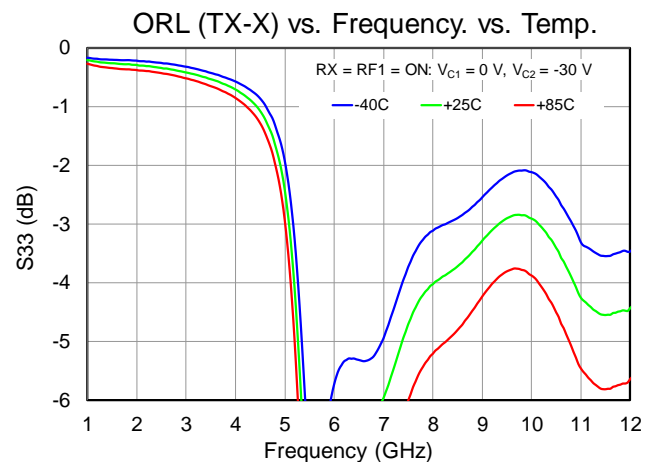
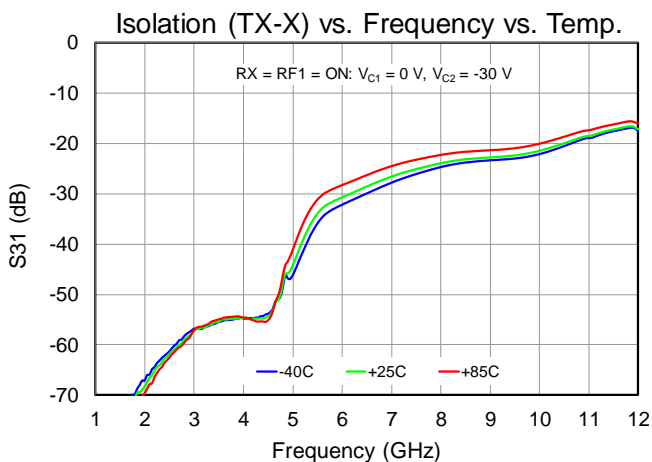
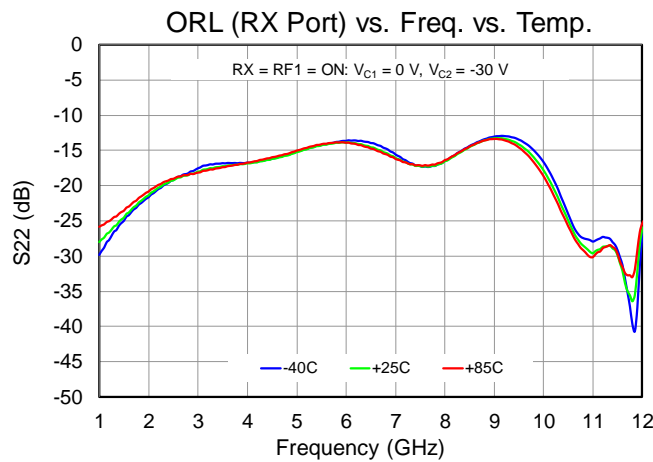
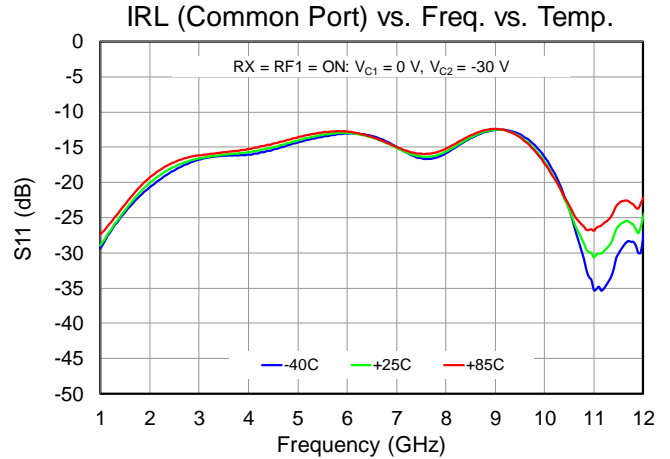
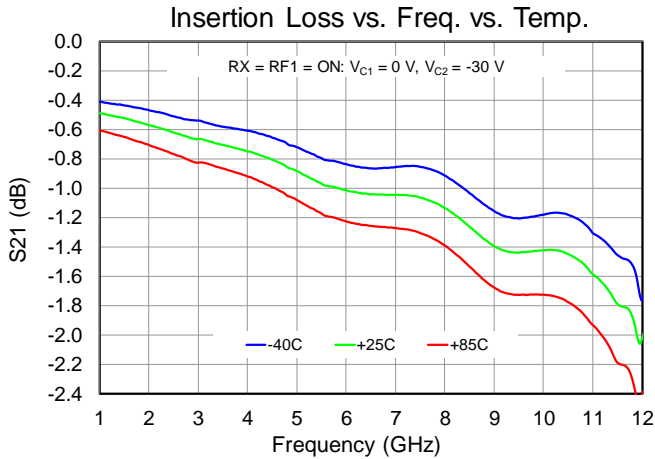

Performance Plots – Small Signal (RX)

Notes: RFC = Port1; RF1 = Port 2 = RX; RF2 = Port 3 = TX-X; RF3 = Port4 = TX-S. See Logic table on Page 21 for Voltage controls

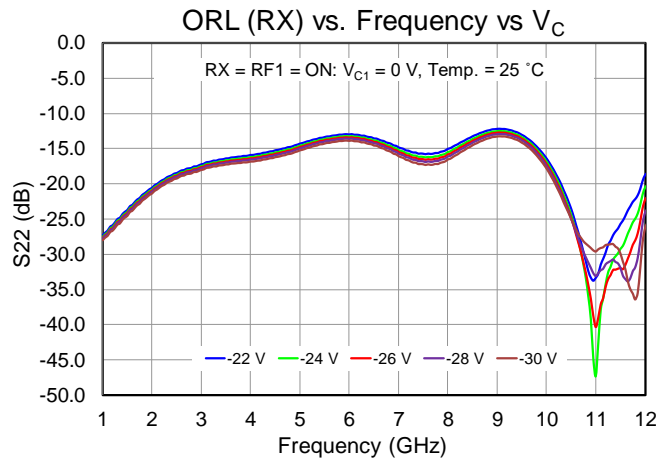
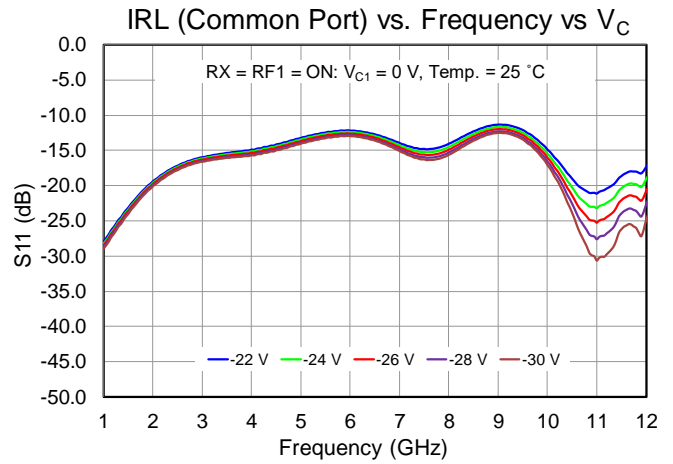
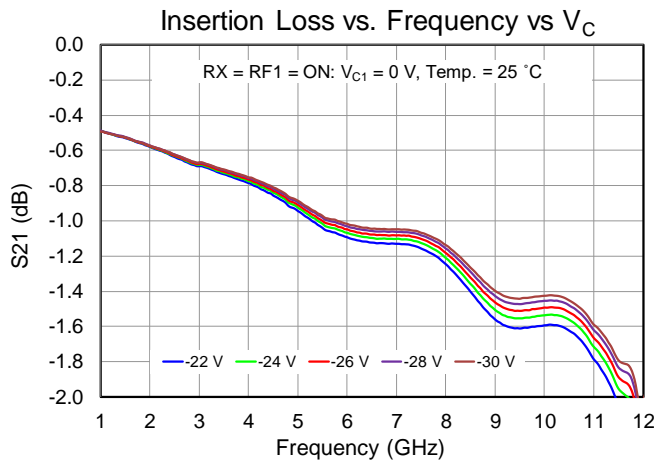
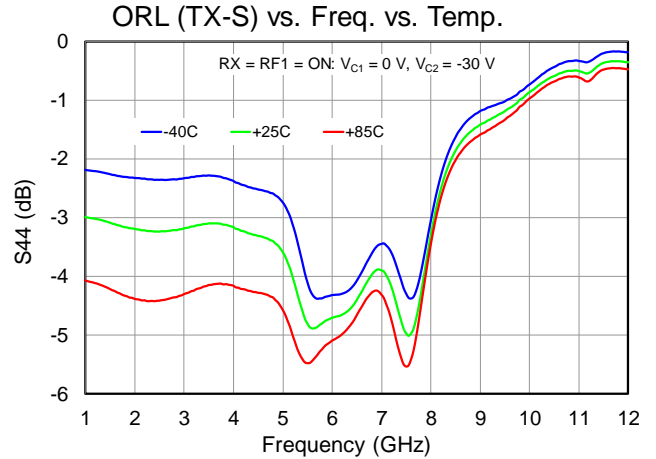
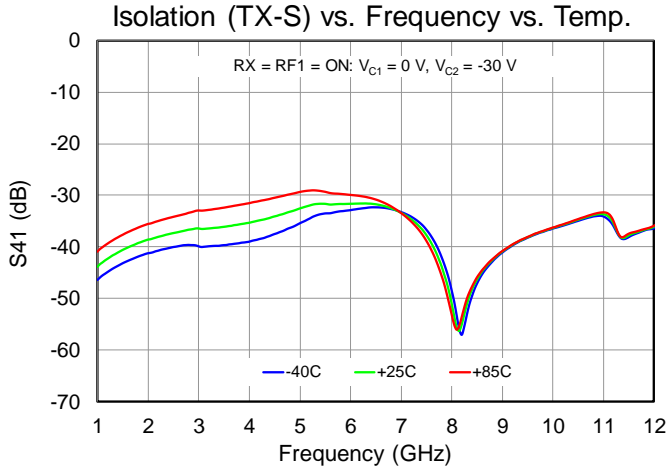

Performance Plots – Small Signal (TX-X)

Notes: RFC = Port1; RF1 = Port 2 = RX; RF2 = Port 3 = TX-X; RF3 = Port4 = TX-S. See Logic table on Page 21 for Voltage controls

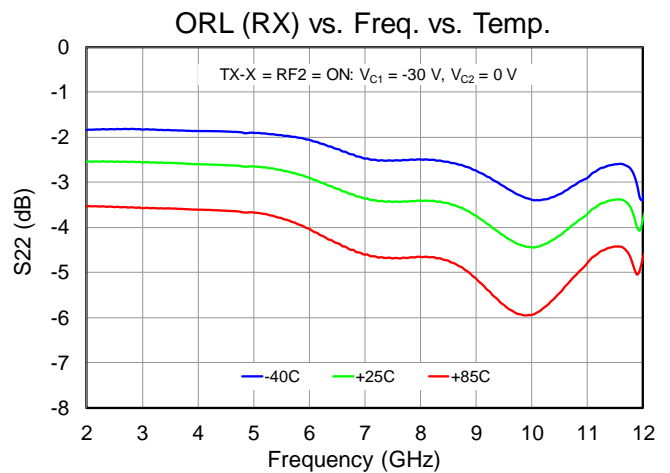
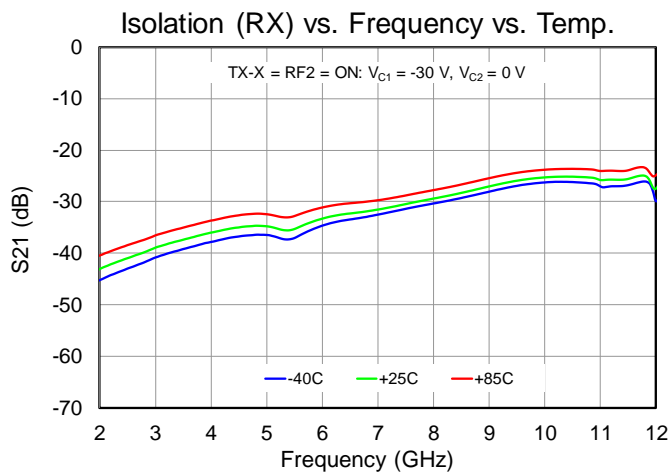
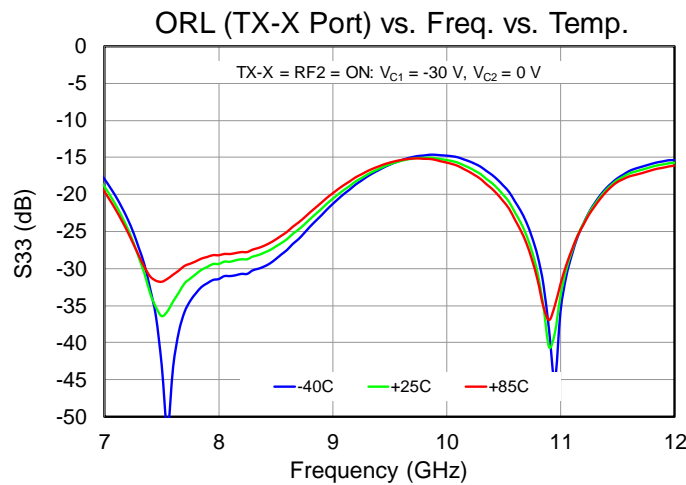
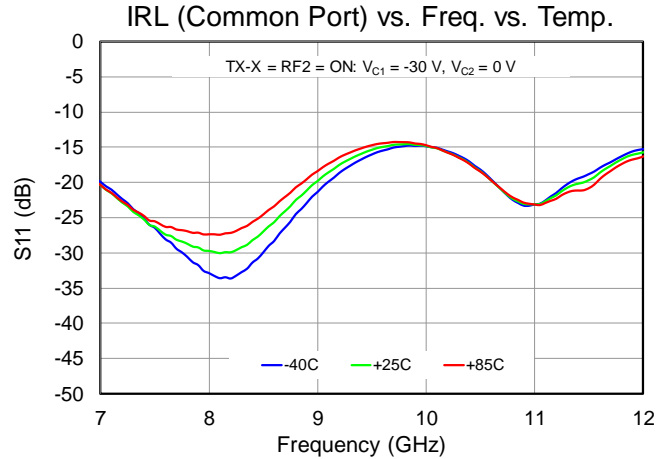
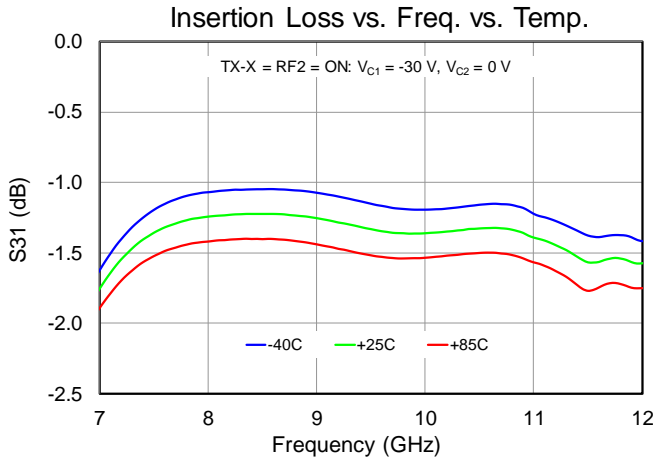

Performance Plots – Small Signal (TX-X)

Notes: RFC = Port1; RF1 = Port 2 = RX; RF2 = Port 3 = TX-X; RF3 = Port4 = TX-S. See Logic table on Page 21 for Voltage controls

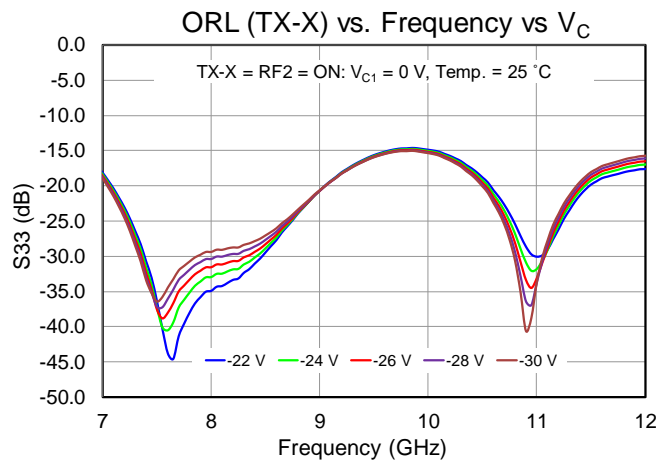
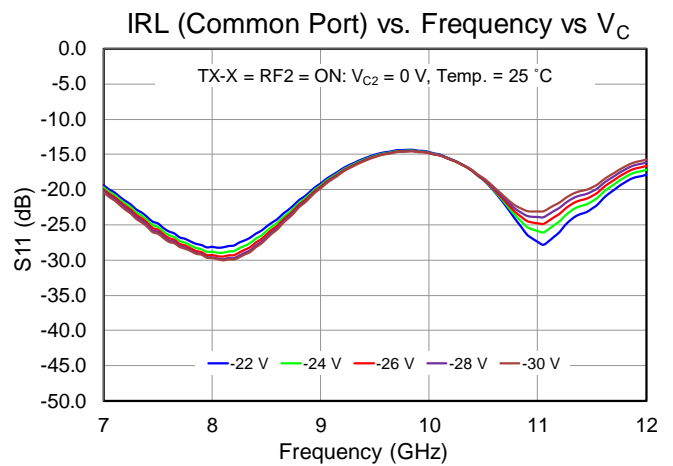
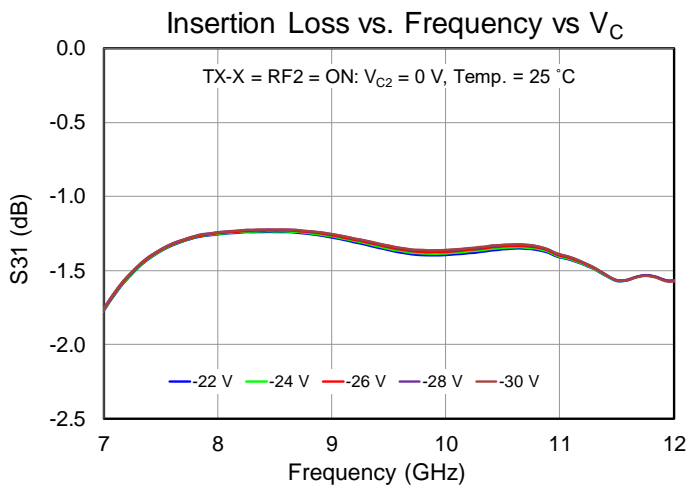
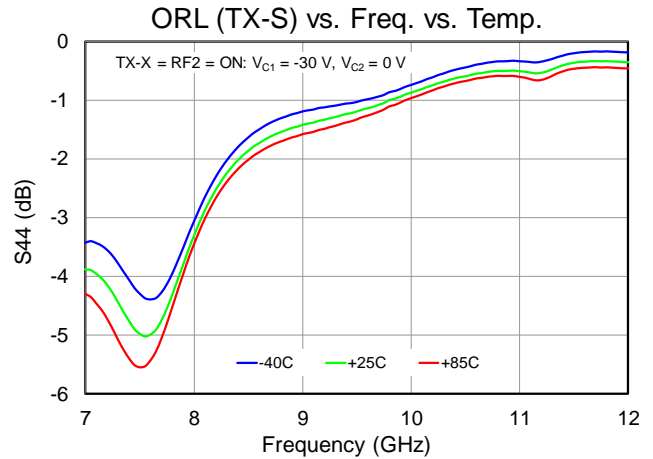
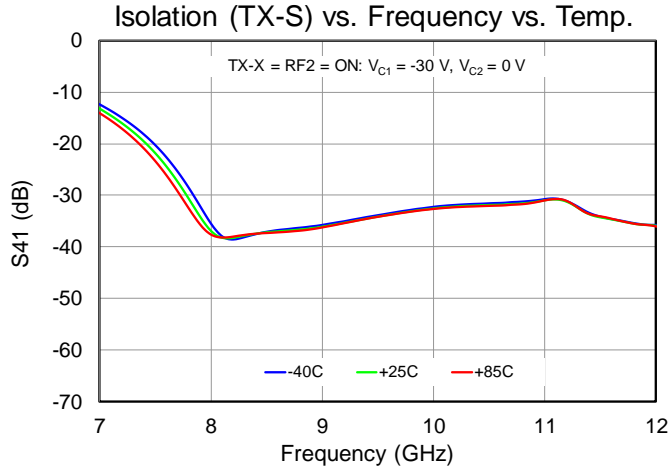

Performance Plots – Small Signal (TX-S)

Notes: RFC = Port1; RF1 = Port 2 = RX; RF2 = Port 3 = TX-X; RF3 = Port4 = TX-S. See Logic table on Page 21 for Voltage controls

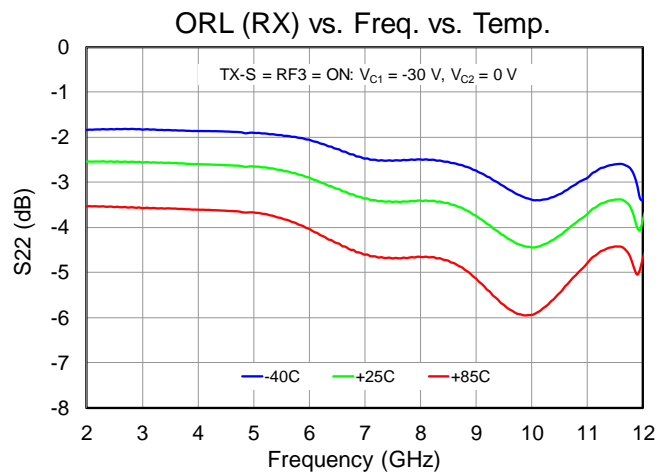
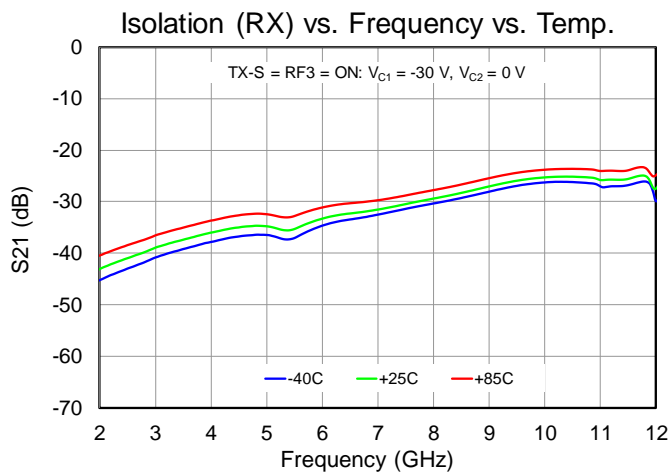
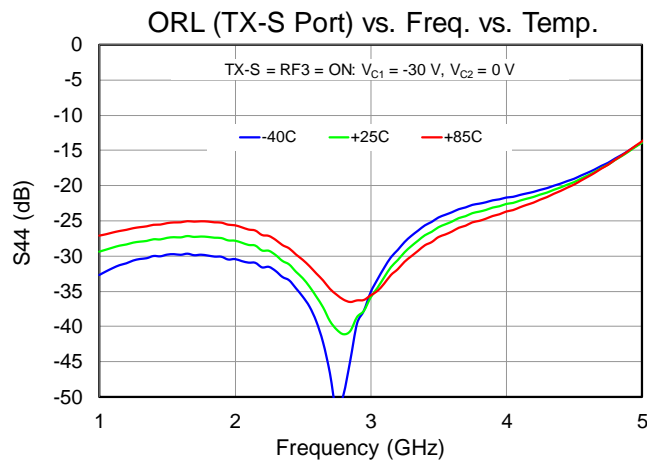
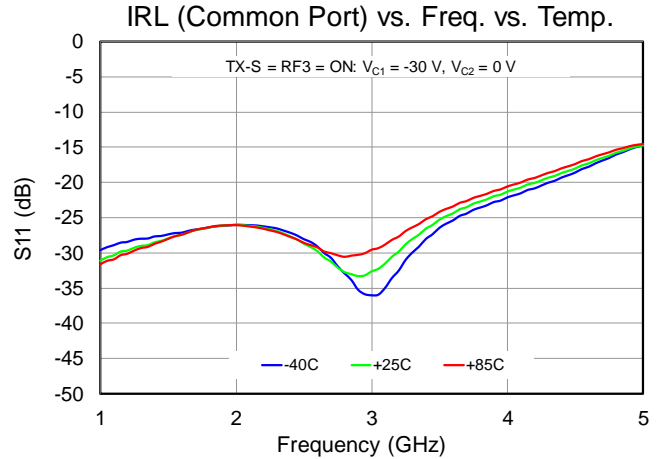
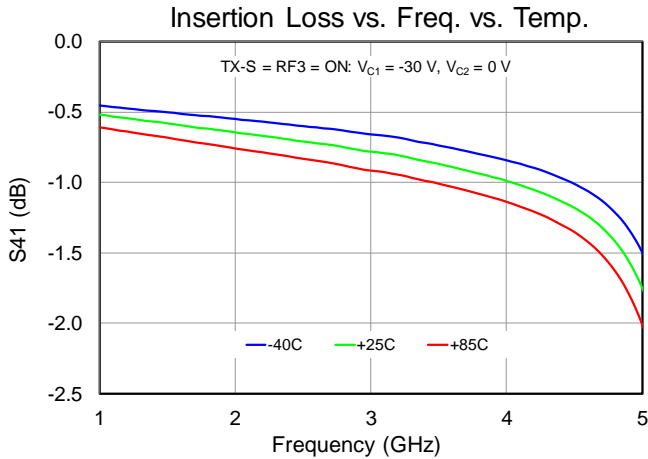

Performance Plots – Small Signal (TX-S)

Notes: RFC = Port1; RF1 = Port 2 = RX; RF2 = Port 3 = TX-X; RF3 = Port4 = TX-S. See Logic table on Page 21 for Voltage controls

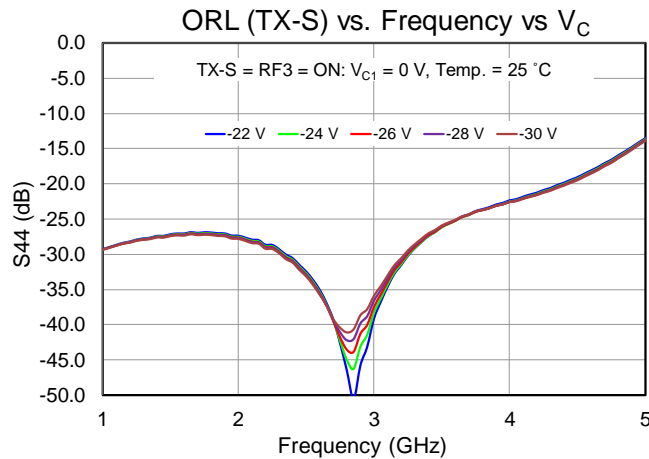
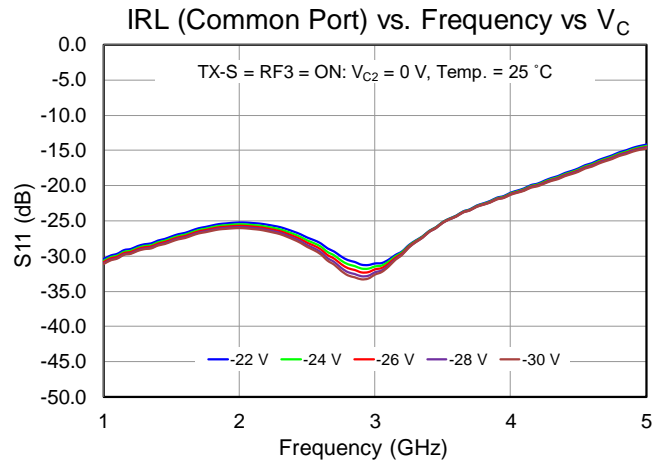
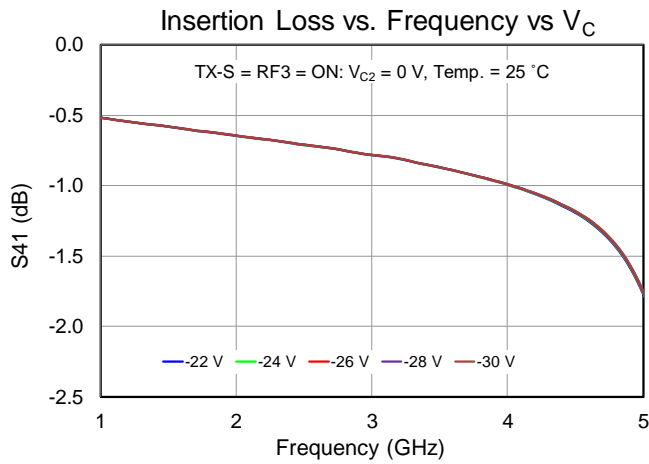
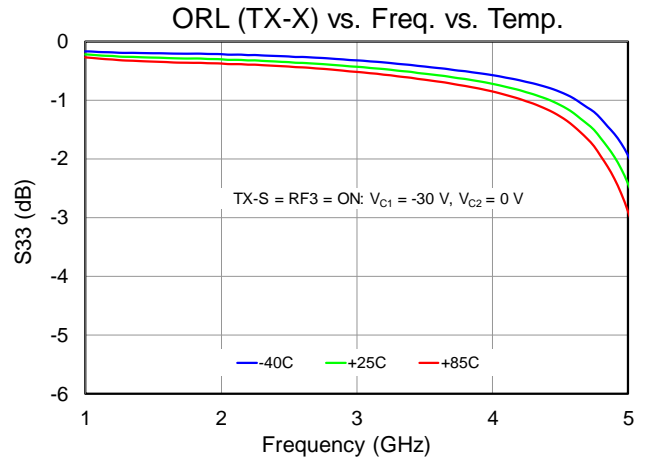
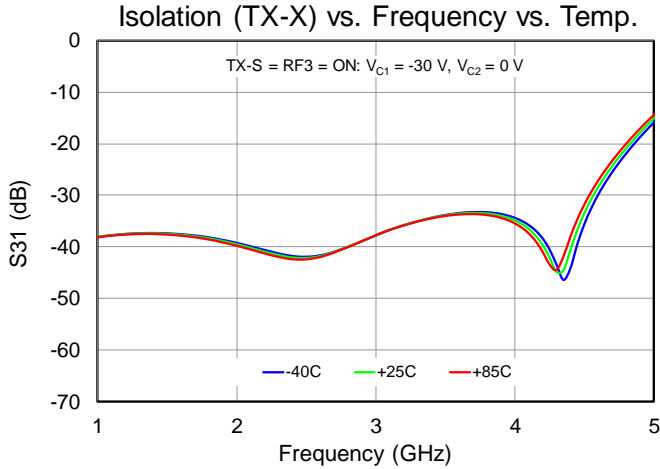

Performance Plots – Large Signal (RX-S)

Notes: RFC = Port1; RF1 = Port 2 = RX; RF2 = Port 3 = TX-X; RF3 = Port4 = TX-S. See Logic table on Page 21 for Voltage controls

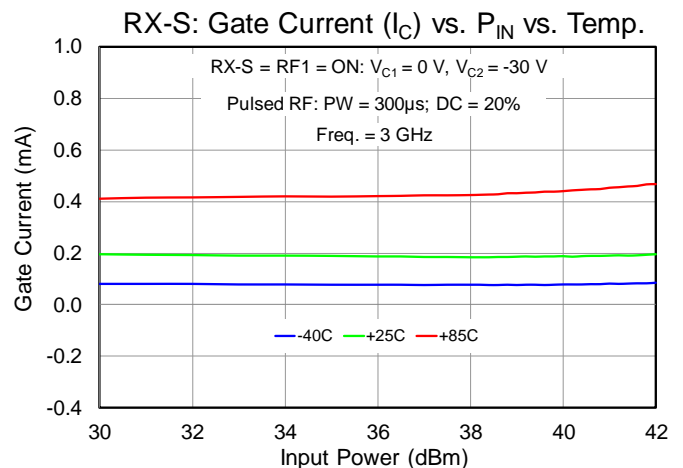
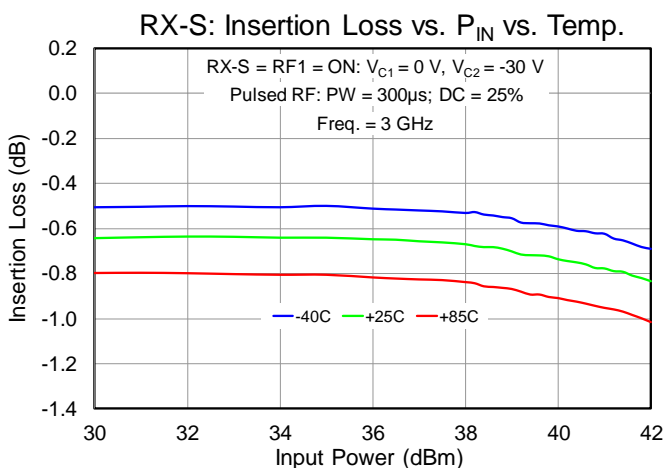
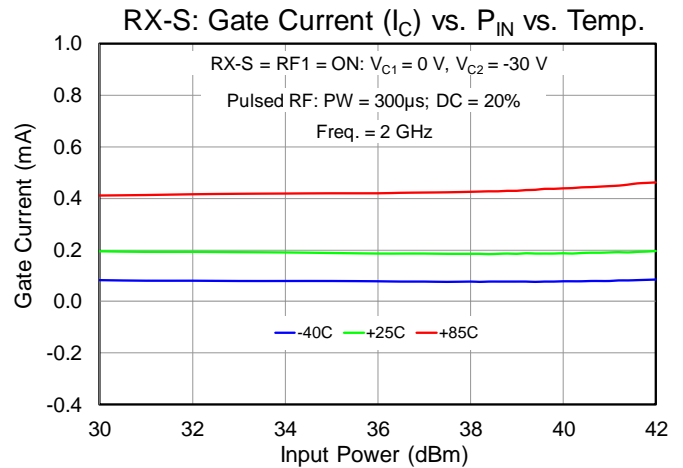
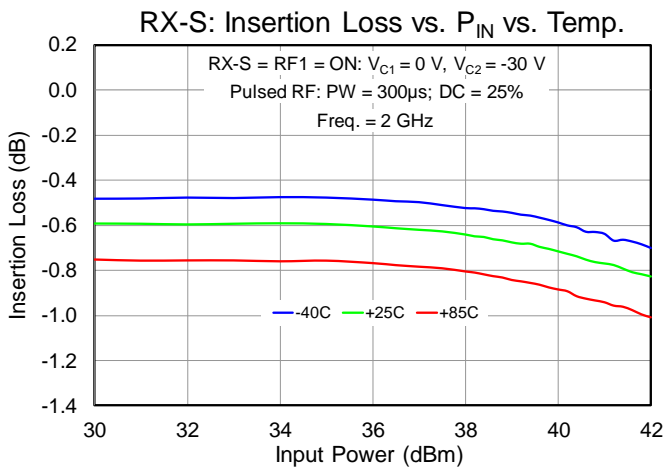
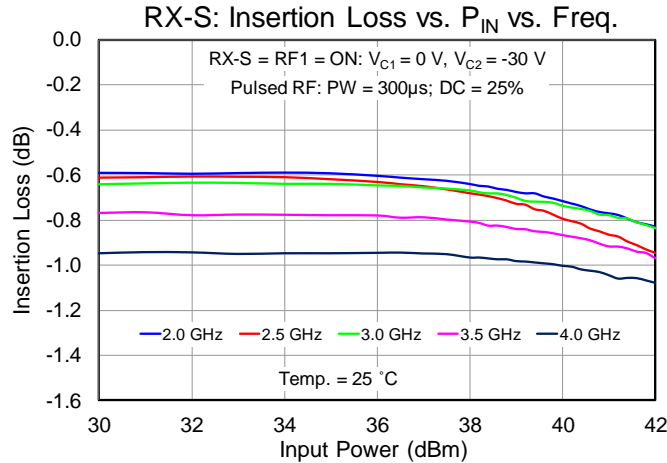

Performance Plots – Large Signal (RX-S / RX-X)

Notes: RFC = Port1; RF1 = Port 2 = RX; RF2 = Port 3 = TX-X; RF3 = Port4 = TX-S. See Logic table on Page 21 for Voltage controls

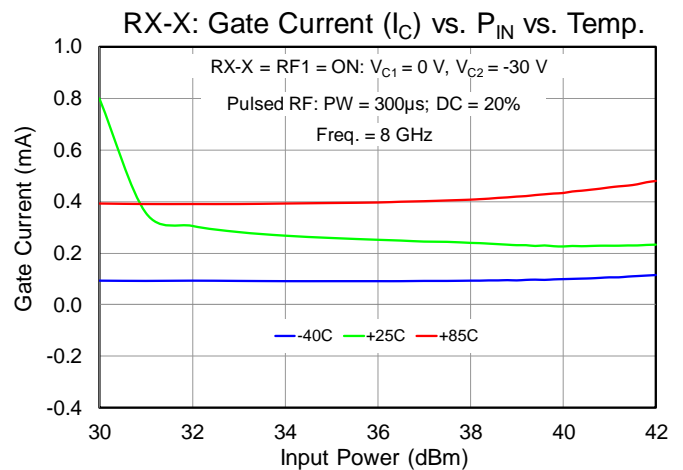
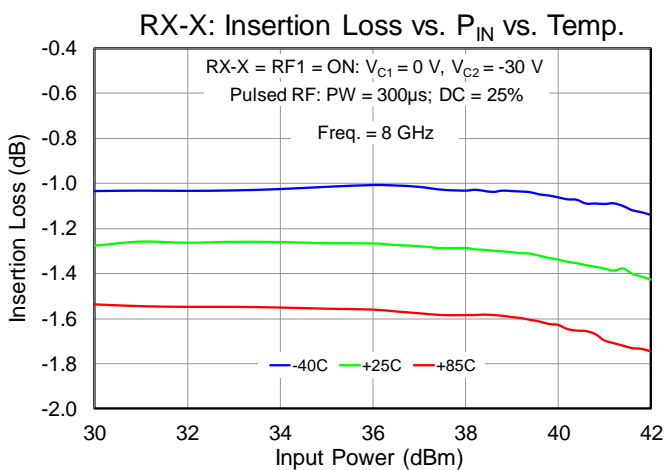
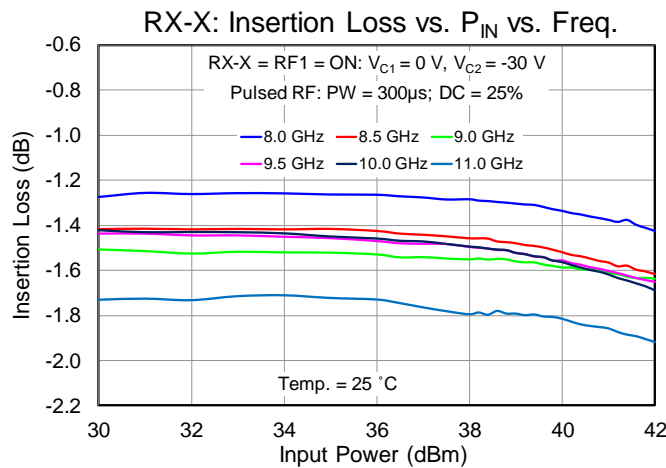
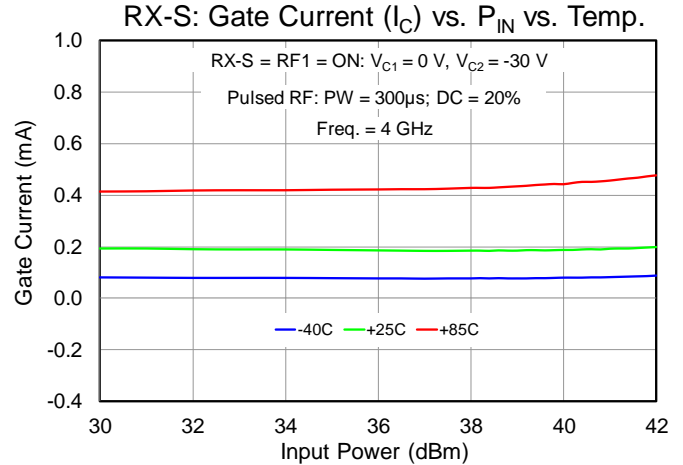
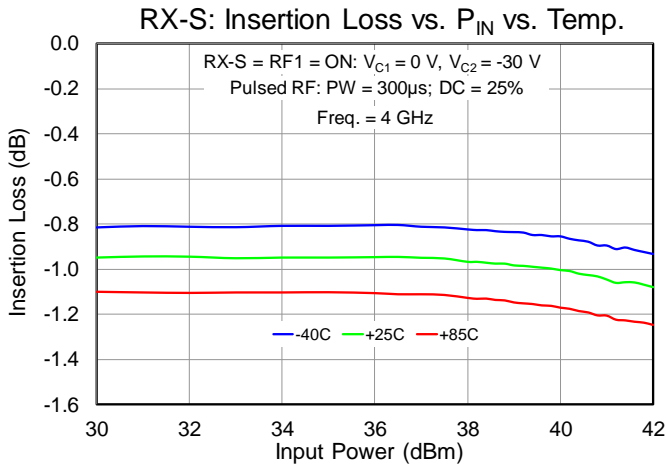

Performance Plots – Large Signal (RX-X)

Notes: RFC = Port1; RF1 = Port 2 = RX; RF2 = Port 3 = TX-X; RF3 = Port4 = TX-S. See Logic table on Page 21 for Voltage controls

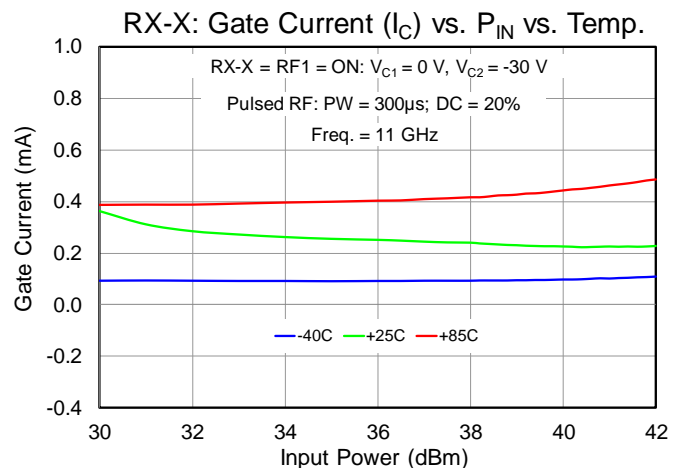
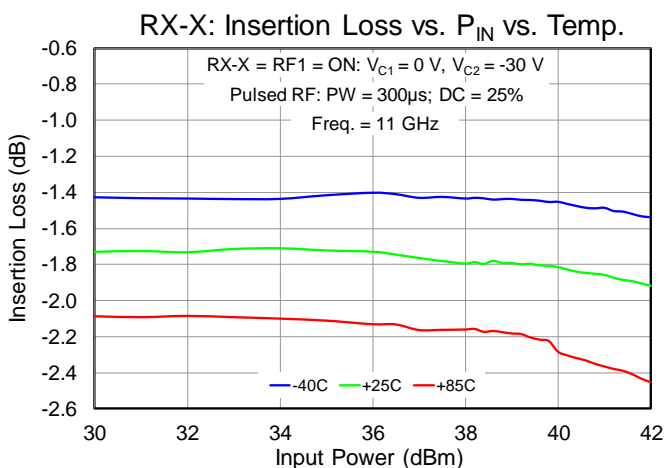
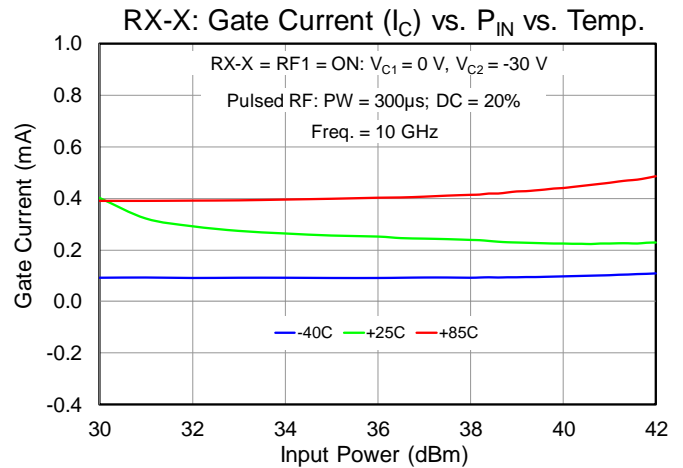
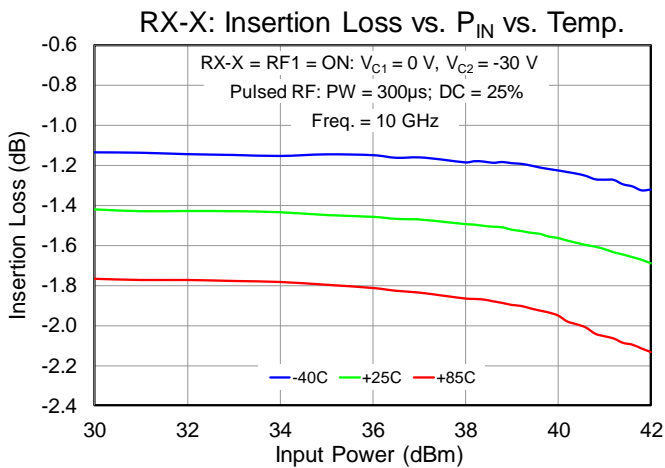
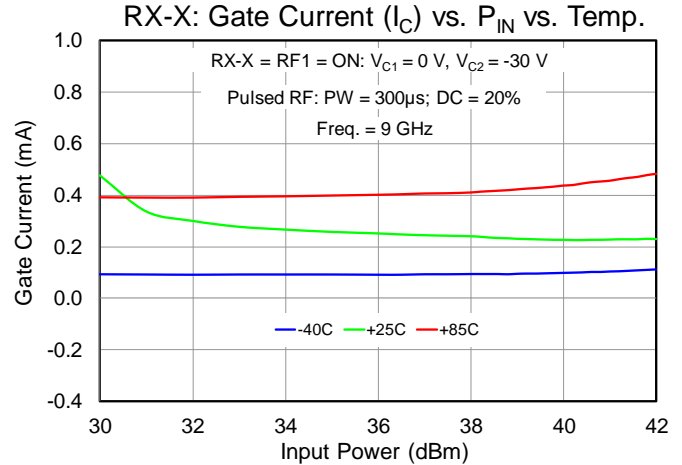
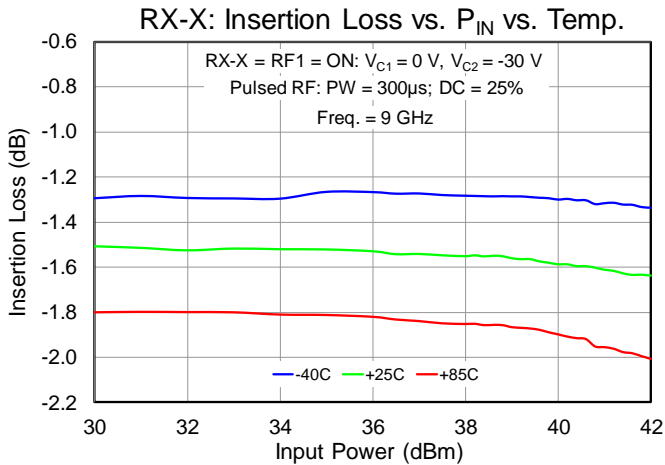

Performance Plots – Large Signal (TX-S)

Notes: RFC = Port1; RF1 = Port 2 = RX; RF2 = Port 3 = TX-X; RF3 = Port4 = TX-S. See Logic table on Page 21 for Voltage controls

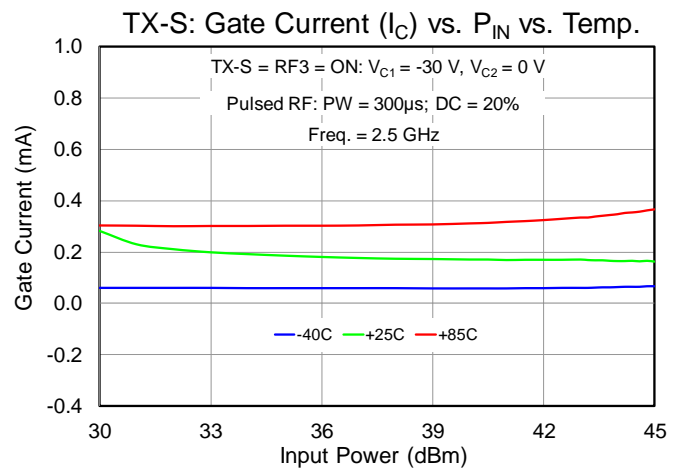
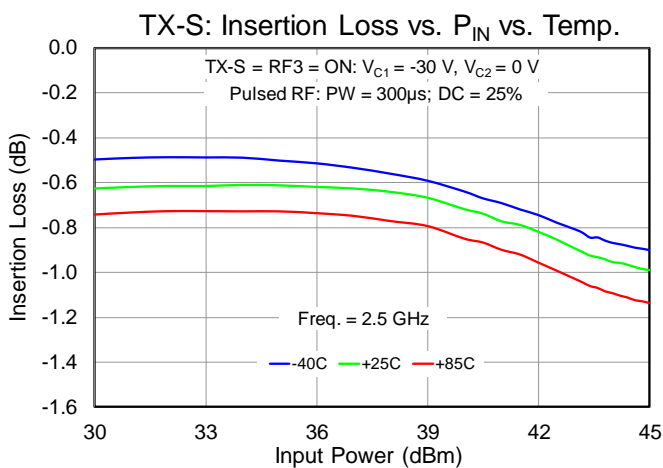
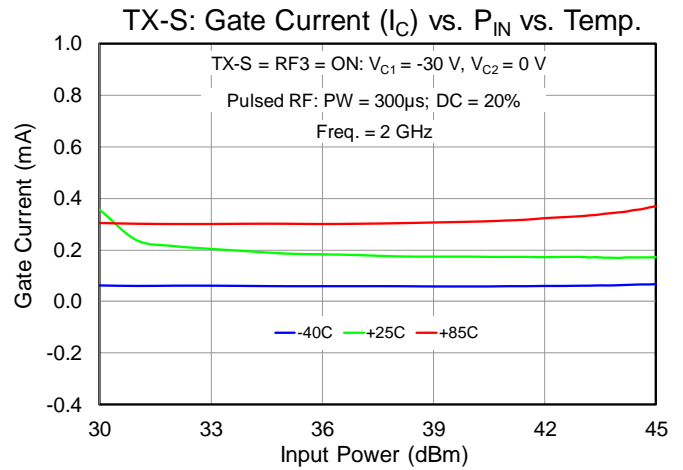
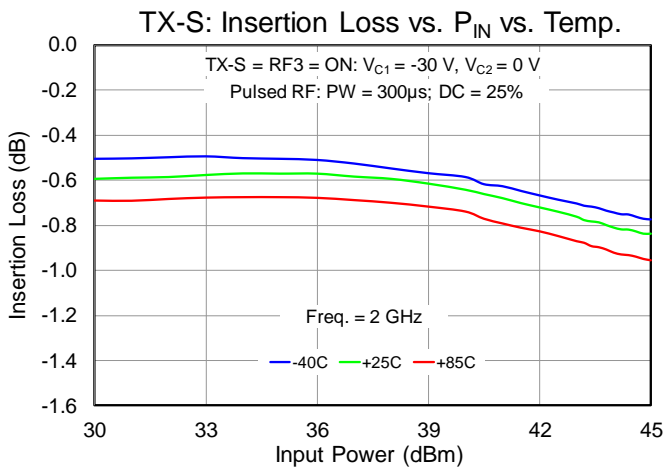
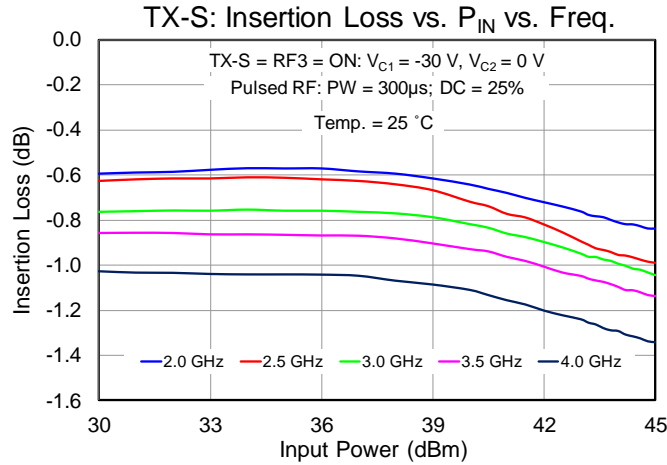

Performance Plots – Large Signal (TX-S)

Notes: RFC = Port1; RF1 = Port 2 = RX; RF2 = Port 3 = TX-X; RF3 = Port4 = TX-S. See Logic table on Page 21 for Voltage controls

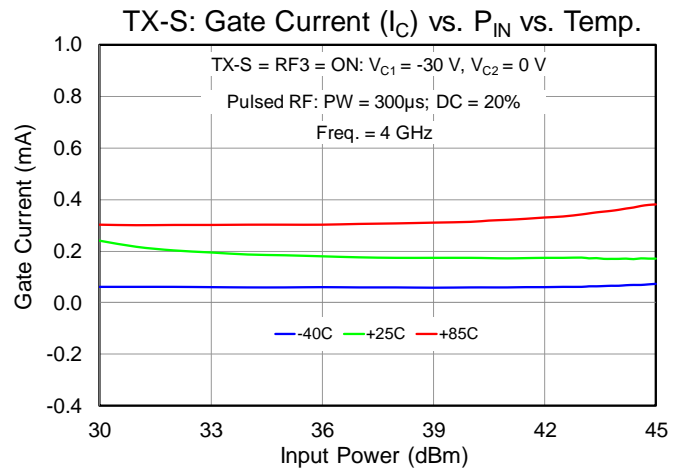
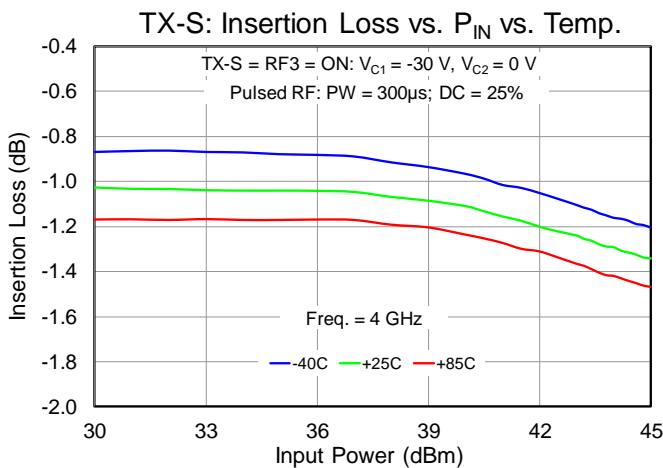
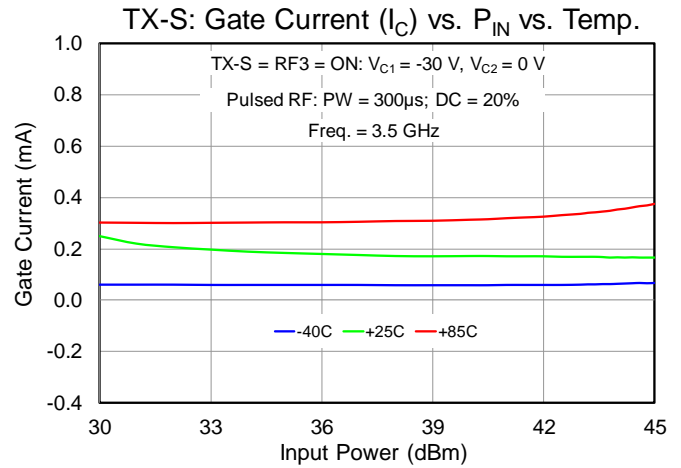
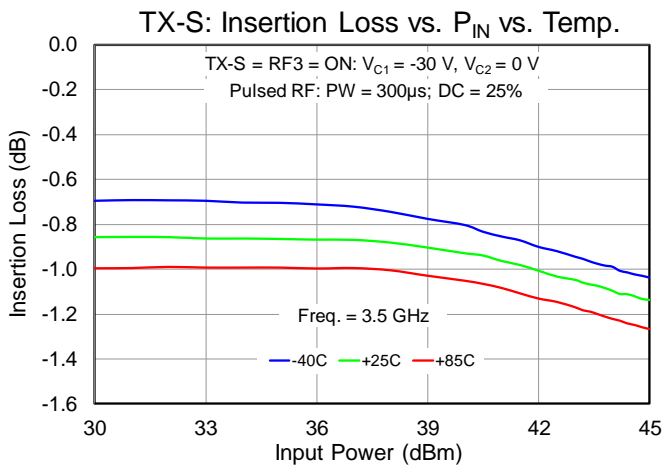
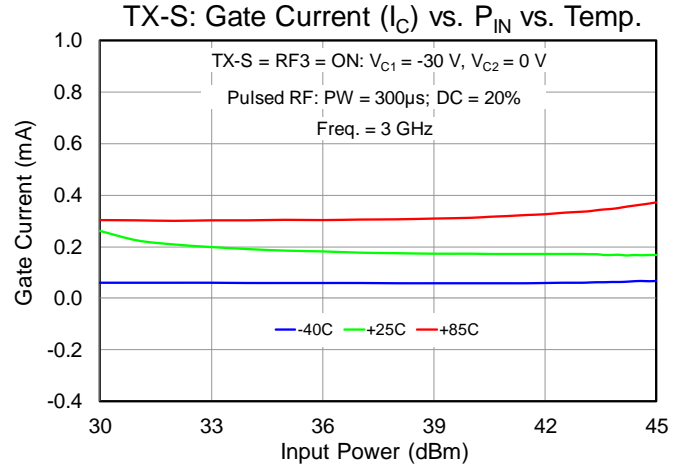
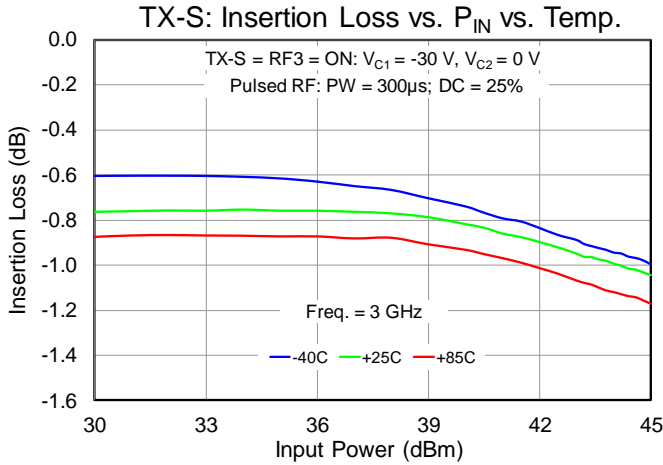

Performance Plots – Large Signal (TX-X)

Notes: RFC = Port1; RF1 = Port 2 = RX; RF2 = Port 3 = TX-X; RF3 = Port4 = TX-S. See Logic table on Page 21 for Voltage controls

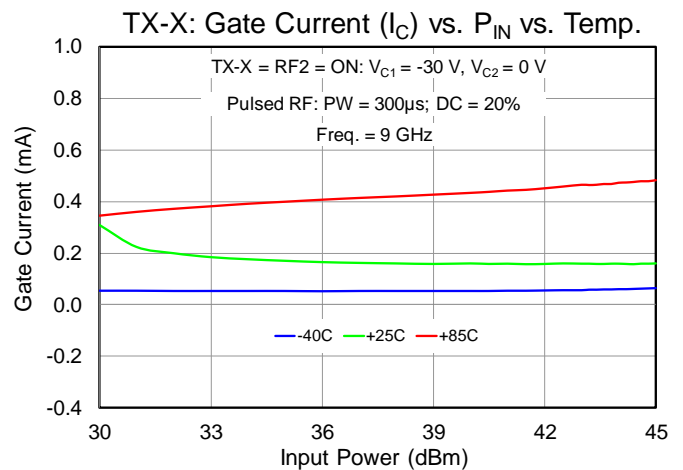
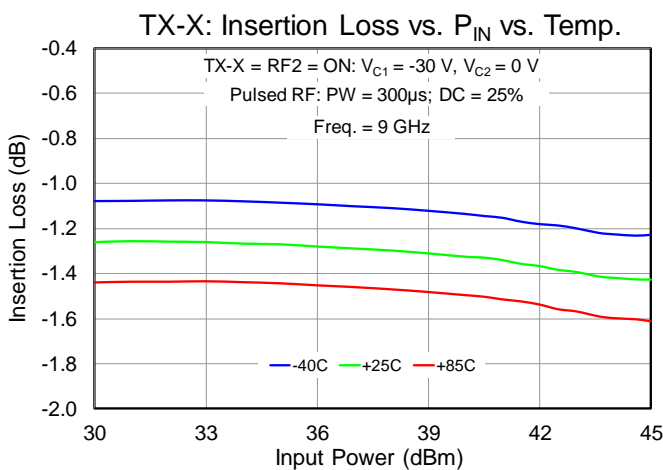
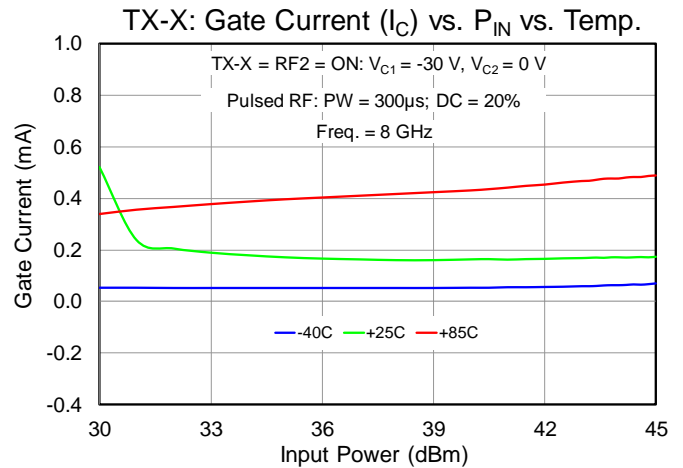
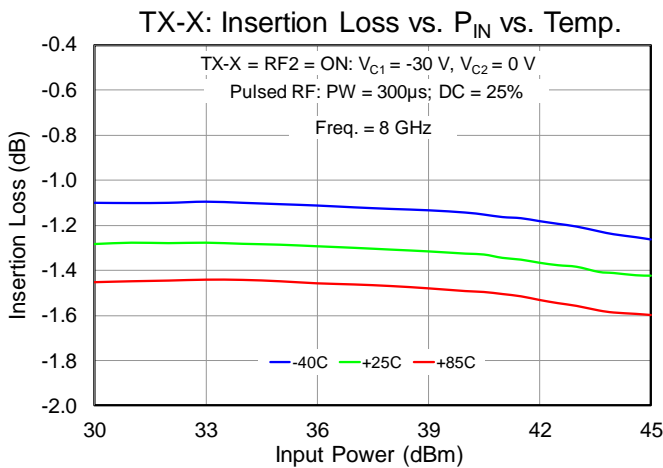
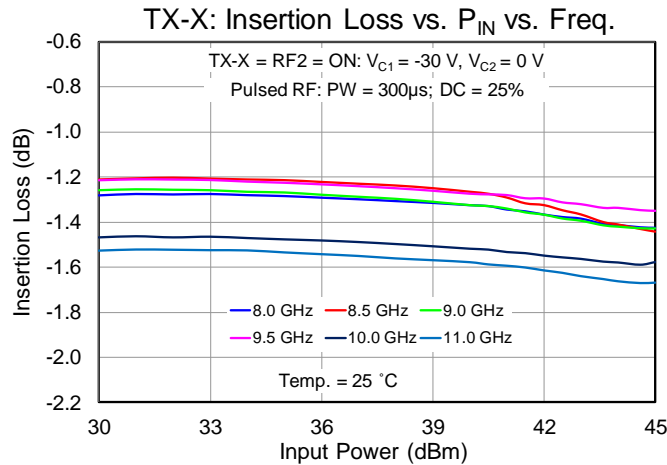

Performance Plots – Large Signal (TX-X)

Notes: RFC = Port1; RF1 = Port 2 = RX; RF2 = Port 3 = TX-X; RF3 = Port4 = TX-S. See Logic table on Page 21 for Voltage controls

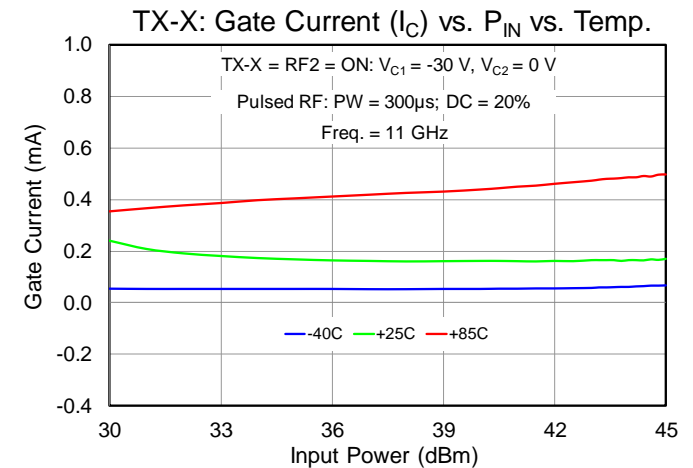
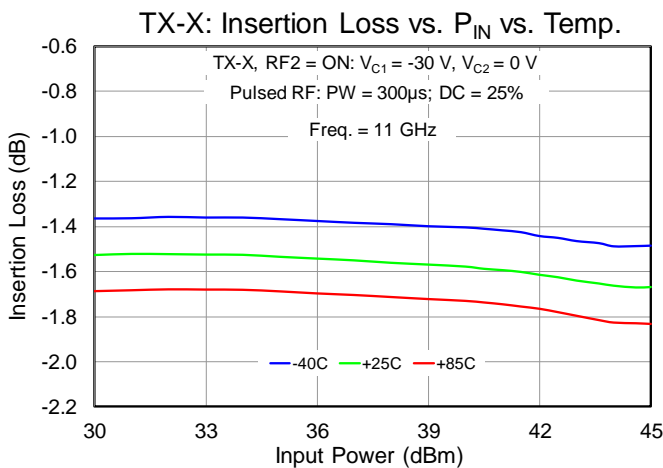
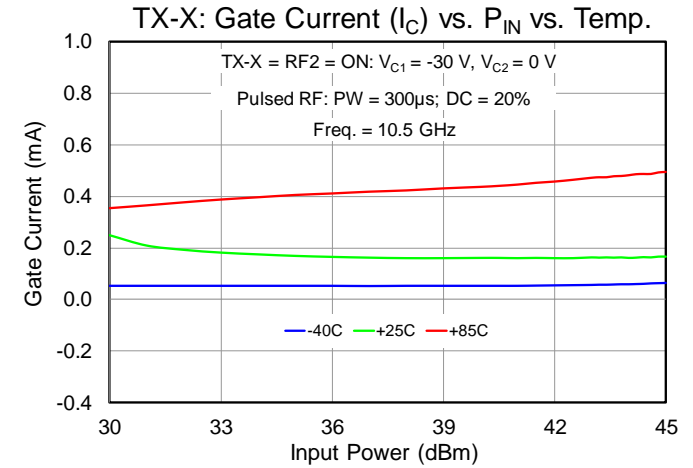
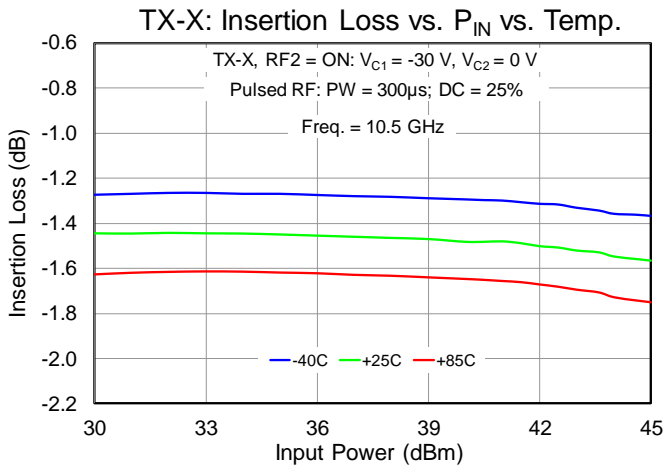
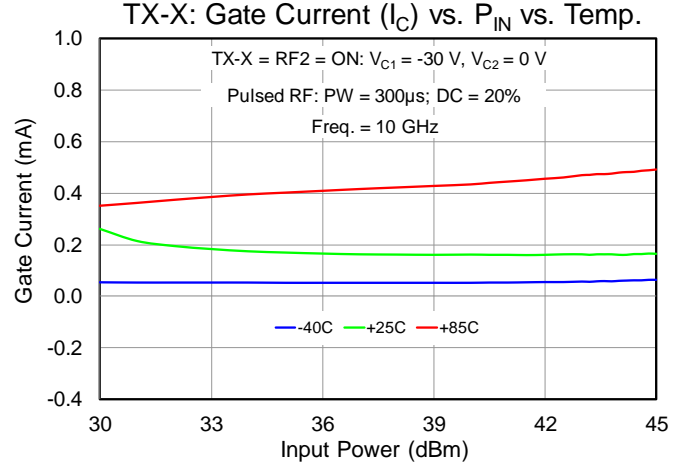
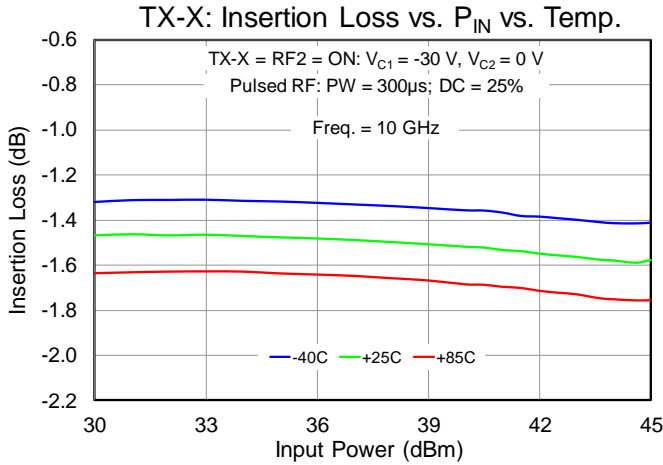

Performance Plots – Harmonics (RX)

Notes: RFC = Port1; RF1 = Port 2 = RX; RF2 = Port 3 = TX-X; RF3 = Port4 = TX-S. See Logic table on Page 21 for Voltage controls

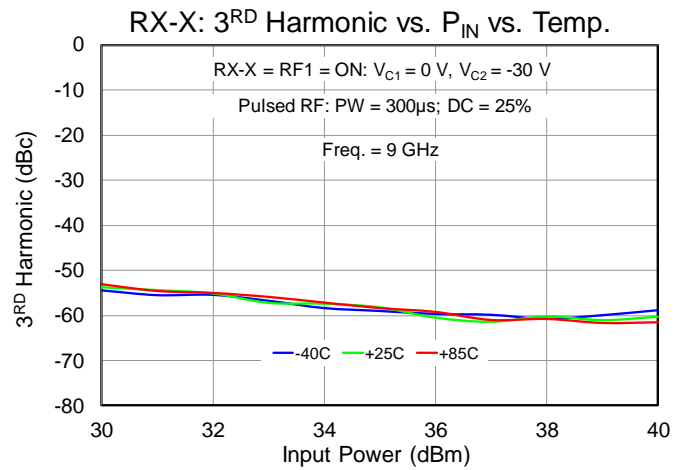
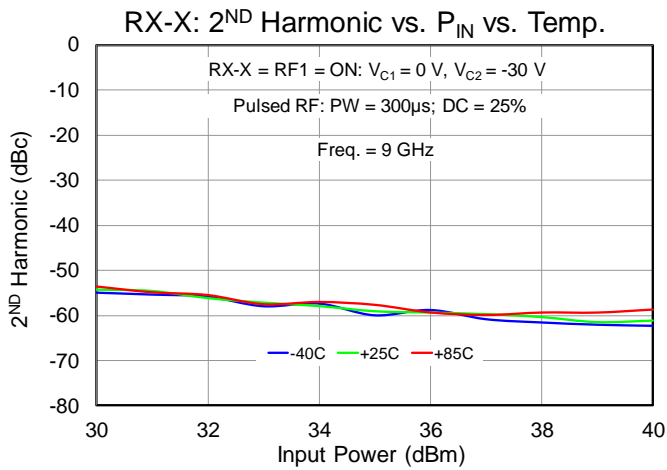
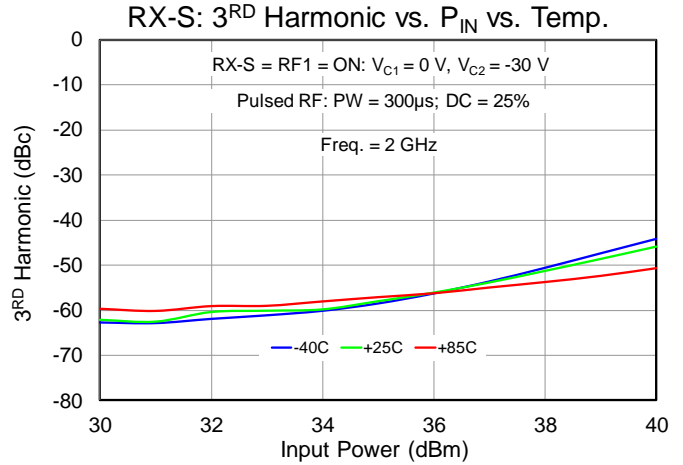
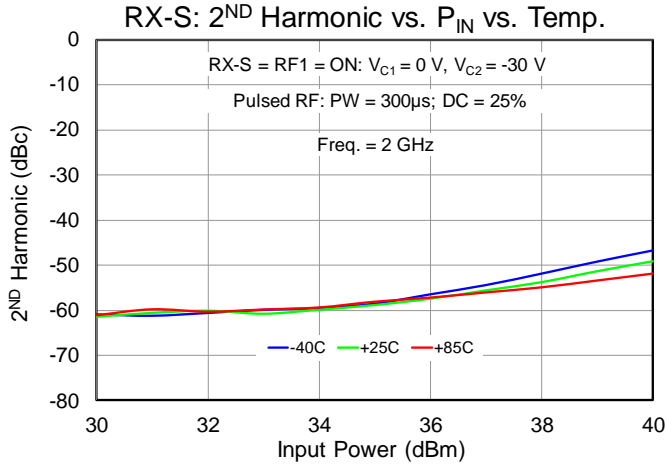

Performance Plots – Harmonics (TX)

Notes: RFC = Port1; RF1 = Port 2 = RX; RF2 = Port 3 = TX-X; RF3 = Port4 = TX-S. See Logic table on Page 21 for Voltage controls

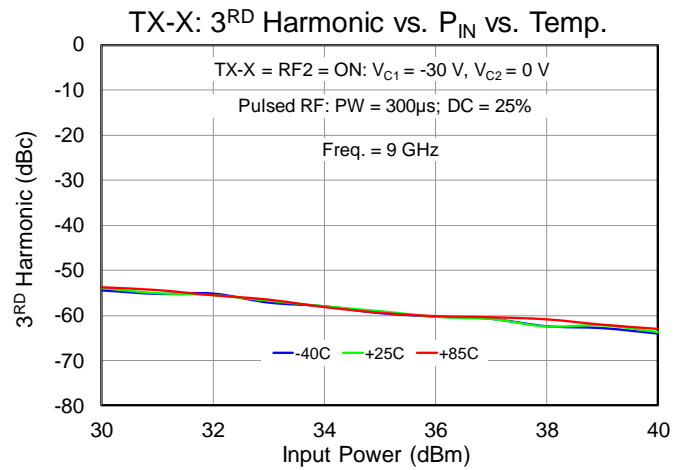
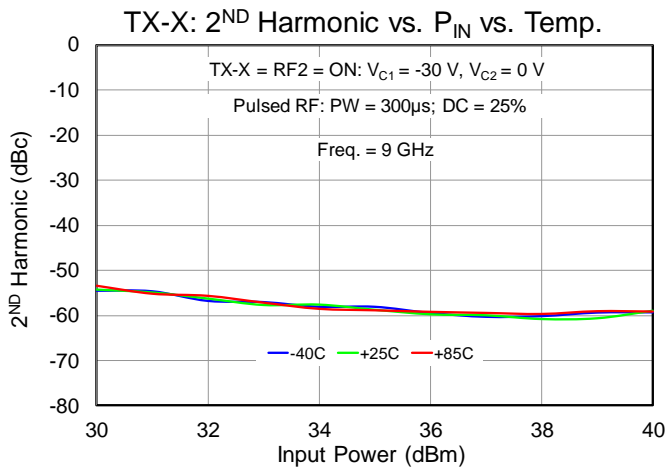
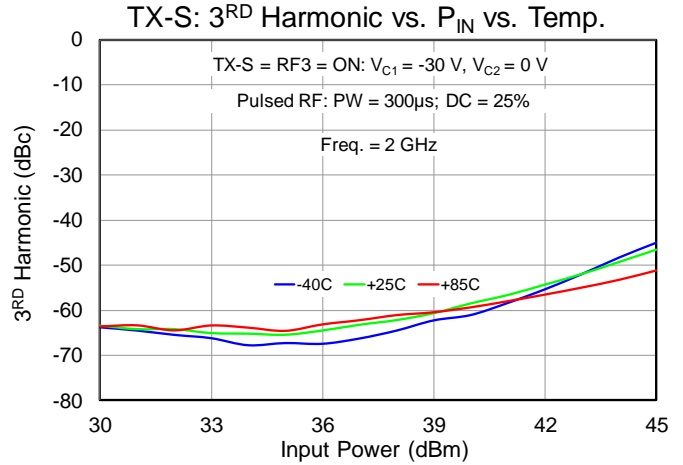
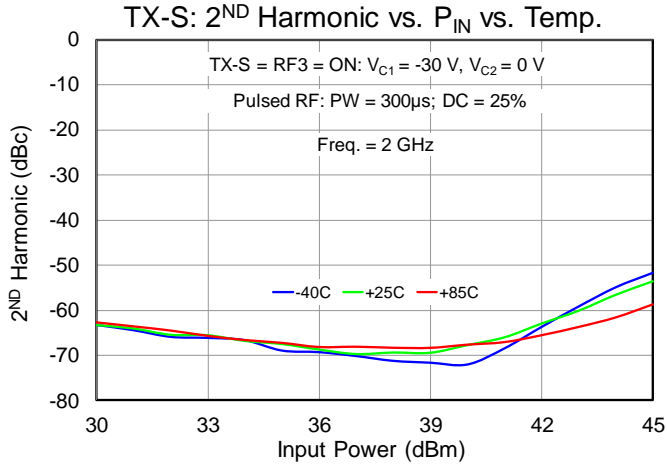

Application Circuit

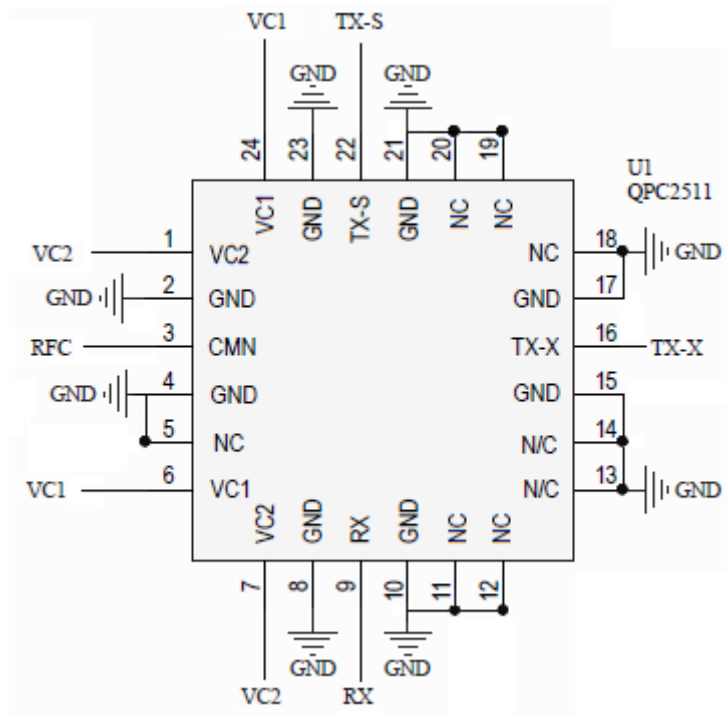

Notes:

1. This switch can be configured as a Single Pole, Single Throw (SPST) by terminating two unused RF switched ports with a 50 Ohm load.
2. External components are not required.

Bias Up Procedure

1. V_{C1} or V_{C2} set to 0 V (see Logic Table for RF Path)
2. V_{C1} or V_{C2} set to -30 V (see Logic Table for RF Path)
3. Apply RF signal to RF Input

Bias Up Down

1. Turn off RF supply
2. Turn V_{C1} or V_{C2} to 0 V
3. Turn V_{C1} or V_{C2} to 0 V

Logic Table (SP3T Truth Table)

RF Path	Operating Mode	State	V_{C1}	V_{C2}
RFC to RF1 ON	10 W RX	On-State (Insertion Loss), TX-S & TX-X = OFF	1	0
RFC to RF2/RF3 ON	30 W TX, S-Band and X-Band	On-State (Insertion Loss), RX = OFF	0	1

- VC High (1) = 0 V
- VC Low (0) = -22, -24, -26, -28 or -30 V

Evaluation Board (EVB) Assembly Layout.

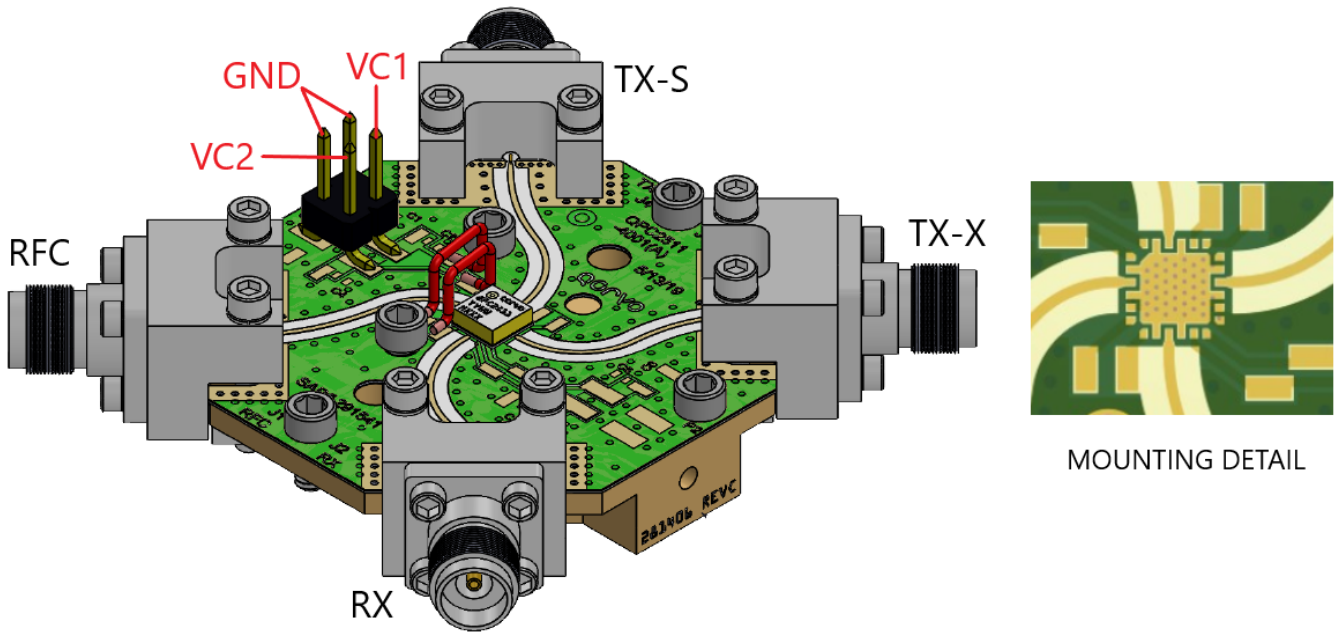

Notes:

1. This switch can be configured as a Single Pole, Single Throw (SPST) by terminating one unused RF switched port with a 50 Ohm load.
2. See Logic Table on page 21 for biasing the voltage controls.
3. External components are not required

Mechanical Information

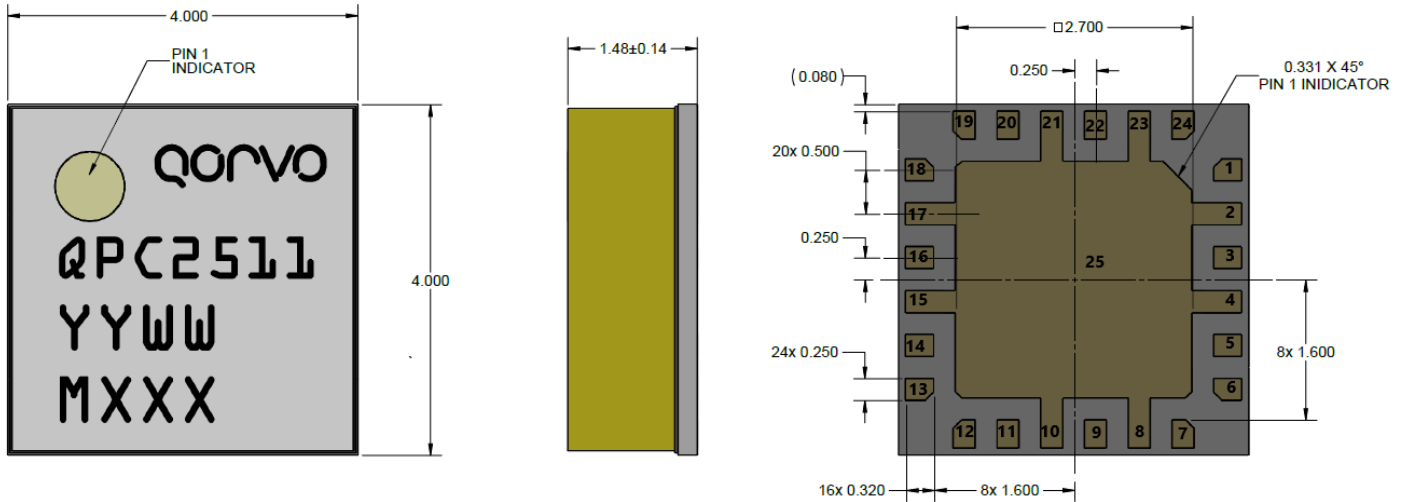

Units: millimeters
Tolerances: unless specified
x.xx = ± 0.25
x.xxx = ± 0.100

Materials:
Package Base: Laminate
Package Lid: FR-4
Packaged Exposed Metallization is gold plated
Part Is Epoxy sealed

Marking:
QPC2511: Part number
YY: Part Assembly year
WW: Part Assembly week
MXXX: Batch ID

Pin Description

Pad No.	Symbol	Description
1,7	V _{C2}	Control voltage #2; External components are not required
2, 4, 8, 10, 15, 17, 21, 23	GND	Ground. Connected to GND paddle (pin 25); should be grounded on PCB to improve isolation
3	RFC	RF common port (port1); matched to 50 Ω; DC coupled
5, 11-14, 18-20	N/C	Not connected internally. Recommended to be grounded at EVB level
6, 24	V _{C1}	Control voltage #1; External components are not required
9	RX	RF switched port 2; matched to 50 Ω; DC coupled
16	TX-X	RF switched port 3; matched to 50 Ω; DC coupled
22	TX-S	RF switched port 4; matched to 50 Ω; DC coupled
25	GND	Backside Paddle. Multiple vias should be employed to minimize inductance and thermal resistance.

Assembly Notes

Compatible with lead-free soldering processes with 260°C peak reflow temperature.

This package is air-cavity and non-hermetic, and therefore cannot be subjected to aqueous washing. The use of no-clean solder to avoid washing after soldering is highly recommended.

Contact plating: Au

Solder rework not recommended

Recommended Soldering Profile

