

Product Overview

The QPC3614 is a 75Ω 6-bit digital step attenuator (DSA) that features high linearity over the entire 31.5dB gain control range in 0.5 dB steps and has a low insertion loss of 1.2dB at 1 GHz. The QPC3614 features three modes of control: serial, latched parallel, and direct parallel programming. Patented circuit architecture provides overshoot-free transient switching performance. QPC3614 is available in a 20-pin 4.2mm x 4.2mm x 0.90mm QFN package.

Functional Block Diagram

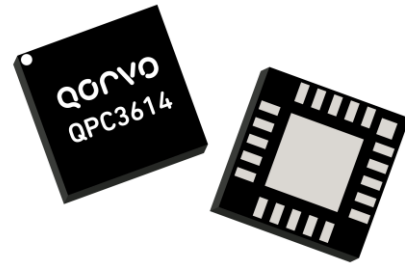
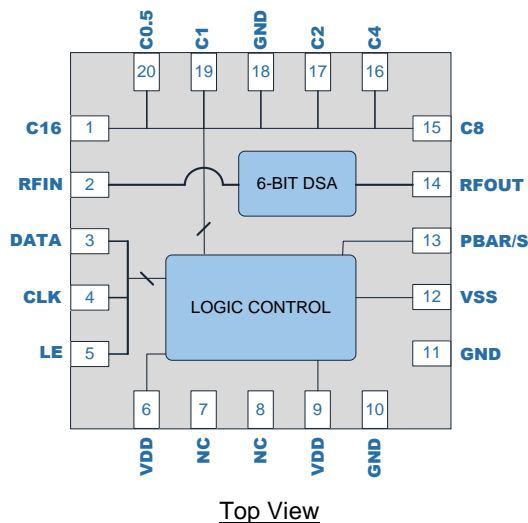

20 Pin 4.2 x 4.2mm QFN Package

Key Features

- 6-Bit, 31.5dB Range, 0.5dB Step
- Patented Circuit Architecture
- Overshoot-free Transient Switching Performance
- Frequency Range 5MHz to 1500MHz
- High Linearity, IIP3 65dBm Typical at 1GHz
- Serial and Parallel Control Interface
- Fast Switching Speed, <500nsec Typical
- RF Pads Have No DC Voltage; Can be DC Grounded Externally
- Option to Turn Off Negative Voltage Generator and Supply V_{SS} Externally
- Power-up Default Setting Is Maximum Attenuation

Applications

- Optical Nodes
- Point-to-Point
- MDU Amplifiers
- Pre-amplifier Attenuation
- Inter-stage Attenuation
- Return Attenuation
- AGC
- Tilt Control

Ordering Information

Part No.	Description
QPC3614SQ	Sample bag with 25 pieces
QPC3614SR	7" Reel with 100 pieces
QPC3614TR13	13" Reel with 2500 pieces
QPC3614PCK	5 - 1500 MHz PCBA with 5 pc. sample bag

Absolute Maximum Ratings

Parameter	Rating
Supply Voltage (V _{DD})	-0.5 to +6.0V
Supply Voltage (V _{SS})	-6.0 to +0.5V
All Other DC and Logic Pads (Supply Voltage Must Be Applied Prior to Any Other Pin Voltage)	-0.5 to V _{DD}
Maximum Input Power at RFIN Pad at 85 °C Case Temperature	+30dBm
Maximum Input Power at RFOUT Pad at 85 °C Case Temperature	+27dBm
Storage Temperature Range	-40 to +150°C

Exceeding any one or a combination of the Absolute Maximum Rating conditions may cause permanent damage to the device. Extended application of Absolute Maximum Rating conditions to the device may reduce device reliability.

Recommended Operating Conditions

Parameter	Min	Typ	Max	Units
Supply Voltage, V _{DD}	+2.7	+5.0	+5.5	V
Supply Voltage, V _{SS}	-5.5	-5.0	-4.5	V
Temperature Range	-40		+105 ⁽²⁾	°C
Junction Temperature			+125	°C

(1) Electrical specifications are measured at specified test conditions. Specifications are not guaranteed over all recommended operating conditions.

(2) RF input power handling derates above 85 °C

Electrical Specifications

Parameter	Condition ⁽¹⁾	Min	Typ	Max	Unit
Supply Current (I _{DD})	Steady state operation, current draw during attenuation state transitions is higher.		190		μA
Supply Current (I _{SS})	Steady state operation, current draw during attenuation state transitions is higher.		110		μA
Frequency Range		5		1500	MHz
Insertion Loss	1GHz		1.2		
Maximum Attenuation			31.5		dB
Absolute Attenuation Error			±(0.2 + 4%)		dB
Input IP3	1GHz, Two tones, 13dBm/tone		65		dBm
Input P0.1dB ⁽²⁾			30		dBm
MER	75dBmV composite, 885MHz		40		dB
CCN	75dBmV composite, 885MHz		49		dB
Return Loss	5MHz – 1200MHz, all states		18		dB
Input and Output Impedance			75		Ω
Switching Speed	50% control to 10% / 90% RF		150		nsec
Digital Logic Low				0.63	V
Digital Logic High		1.17			V
Thermal Resistance, θ _{jc}	Junction to case		67		°C/W

Notes:

1. Typical performance at these conditions: Temp = +25°C, 1000MHz, V_{DD} = +5V, V_{SS} = 0V, 75Ω system.
2. Figure of merit – exceeds maximum input power of device.
3. MER Test Conditions: 190 QAM256 Channels, 57-1215MHz, ITU-T J.83, Annex B
4. CCN test procedure according to ANSI/SCTE 17. System BW 5.36MHz.

Evaluation Board Schematic; 5 – 1500MHz

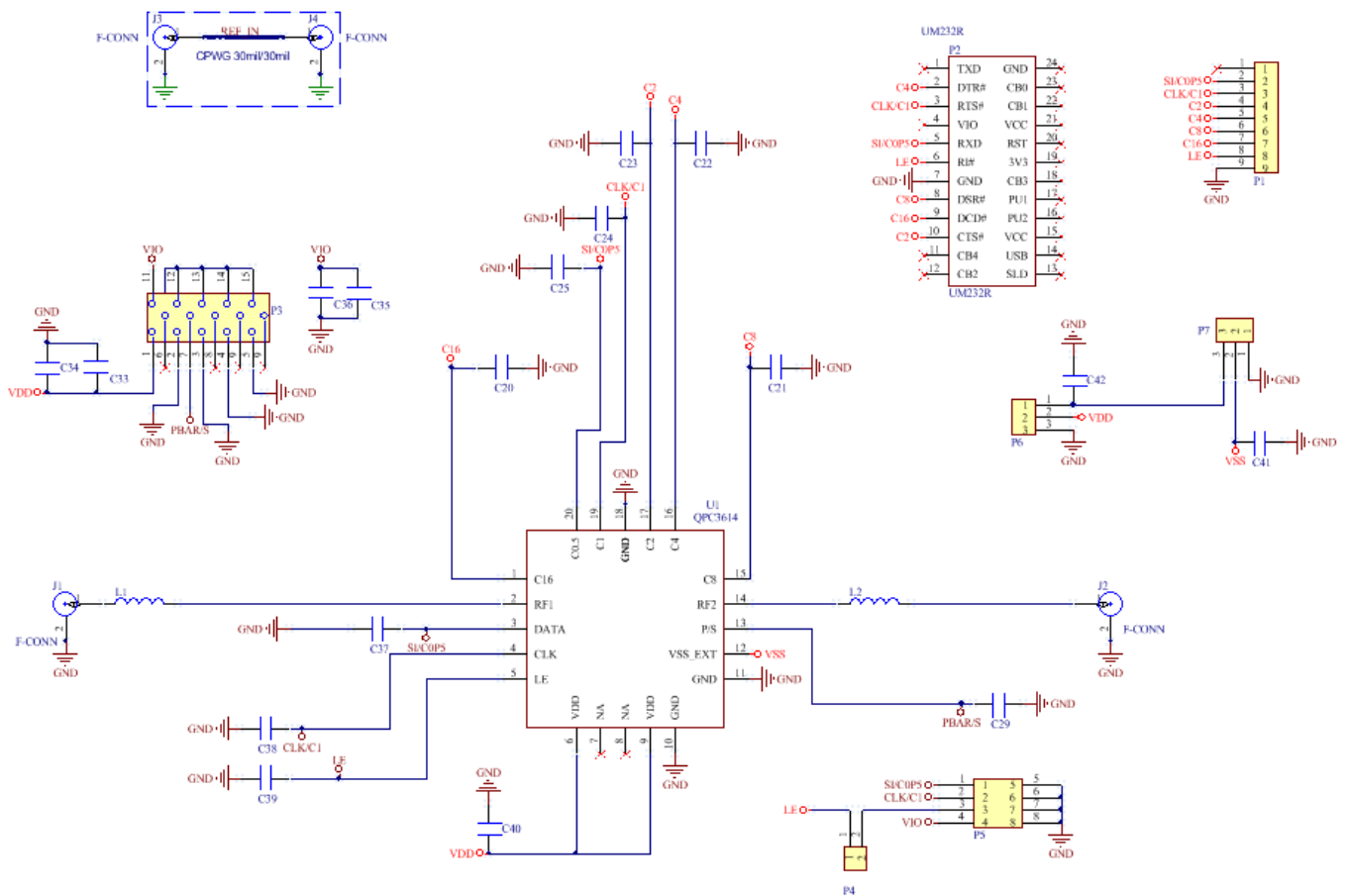



QPC3614

75Ω 5 –1500MHz Digital Step Attenuator

Ref. Designator	Description	Manufacturer	Part Number
PCB	QPC3614-4000	Viasystems	QPC3614-4000(A)
U1	Digital Step Attenuator, 5 MHz to 1500 MHz	Qorvo	QPC3614SB
C34, C42	CAP, 1 μF, 10%, 25 V, X7R, 1206	Taiyo Yuden (USA), Inc.	CE TMK316BJ105KL-T
J1 - J4	CONN, F FEM, EDGE MOUNT, 75 Ω, 0.065"	Genesis Technology USA	GT20-300204
P1	CONN, HDR, ST, 9-PIN, 0.100"	Samtec Inc.	TSW-109-07-G-S
P3	CONN, HDR, ST, 3 x 5, 0.100", T/H	Samtec Inc.	TSW-105-07-L-T
P4	CONN, HDR, ST, 2-PIN, 0.100"	Samtec Inc.	TSW-102-07-G-S
P5	CONN, HDR, 2 x 4, RA, 0.100", T/H	Samtec Inc.	TSW-104-08-G-D-RA
P2	CONN, SKT, 24-PIN DIP, 0.600", T/H	Aries Electronics Inc.	24-6518-10
P6	CONN. HDR, SRT, PLRZD, 3-PIN, 0.100"	ITW Pancon	MPSS100-3-C
P7	CONN, HDR, ST, 2-PIN, 0.100"	Samtec Inc.	TSW-102-07-G-S
M1 (See Note 1)	MOD, USB TO SERIAL UART, SSOP-28	Future Technology Devices Int'l	UM232R
S1, S2, S7	JMPR, 2-PIN	3M Interconnect Solutions	929950-00
C40, C41	CAP, 1000pF, 10%, 50V, X8L, 0402	Murata Electronics	GCM155L81H102KA37D
L1, L2	IND, 3.9nH, +/-0.3nH, M/L, 0402	Murata Electronics	LQG15HN3N9S02D
C20 - C25, C29, C33, C35 - C39, S6	DNP	N/A	N/A

Notes:

1. M1 should be mounted into P2 with respect to the Pin 1 alignment of M1 and P2.
2. Jumpers S1 and S2 should be installed on P3. Jumper S6 is DNP.
3. Jumper S7 should be installed on P7.

Evaluation Board Assembly Drawing

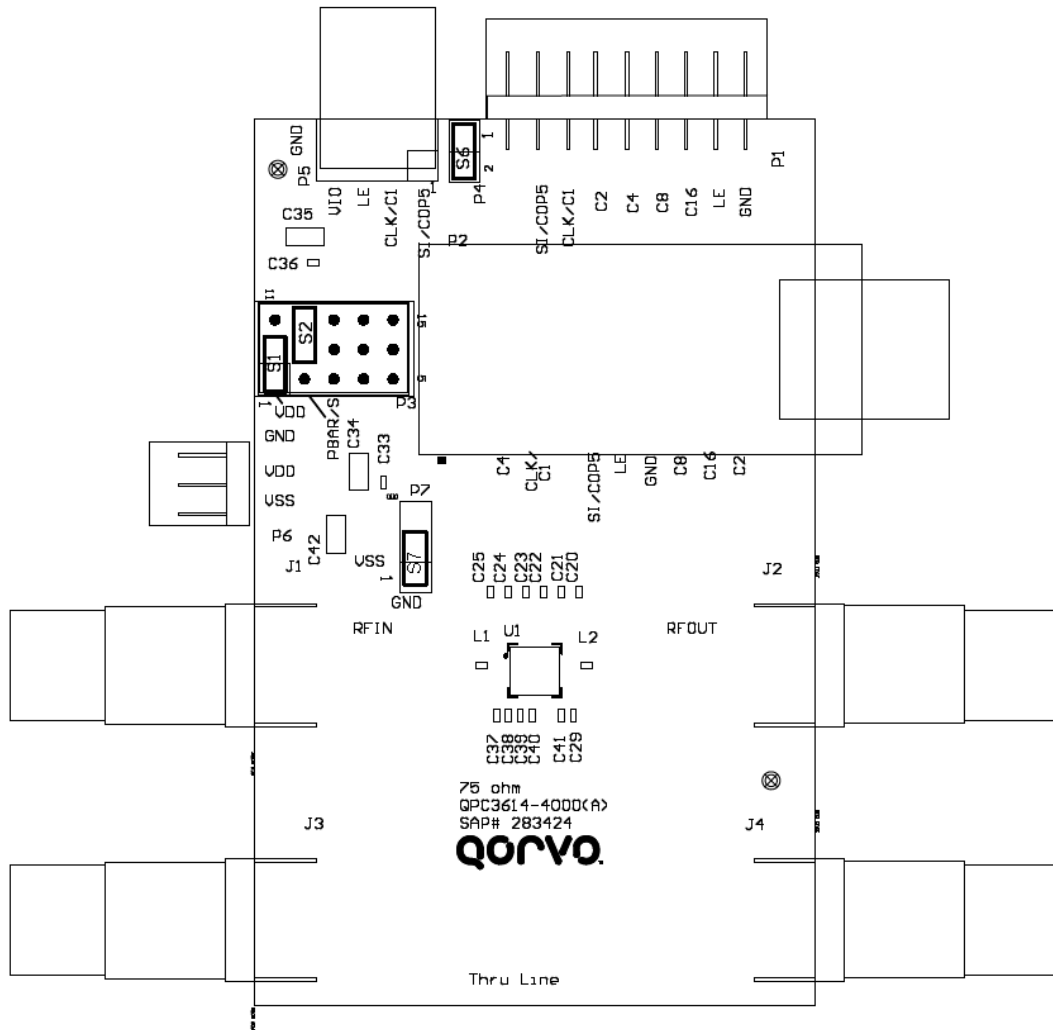

On Board Jumpers

Jumpers	Connector	Signal	Position	U1 Connection	Comment
S1	P3	Logic Voltage	0 (Default)	VDD From P6	
			1	VIO From P5	
S2	P3	PBar/S	0	GND	Parallel Mode
			1 (Default)	U1_VDD	Serial Mode
S6	P4	LE	OPEN (Default)	LE (from UM232R)	Only install for external SPI control through P5
			INSTALLED	LE (from P5.3)	
S7	P7	VSS	0 (Default)	VSS to GND	Use to tie VSS to Ground to enable internal NVG or connect to P6 for external negative supply.
			1	VSS From P6	

Performance Plots

Test conditions unless otherwise noted: $V_{DD} = +5V$, $V_{SS} = 0V$, $Temp = +25^{\circ}C$, $Z_o = 75\Omega$

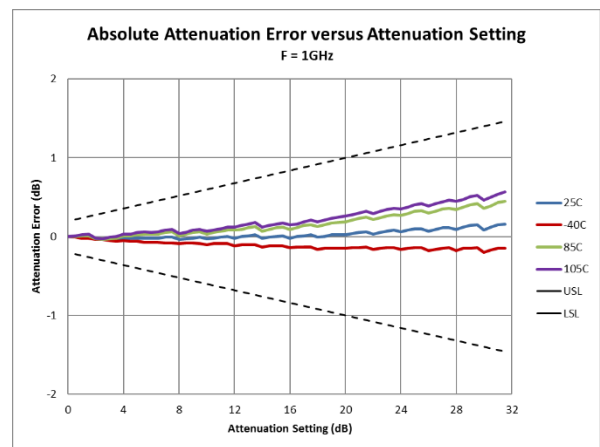
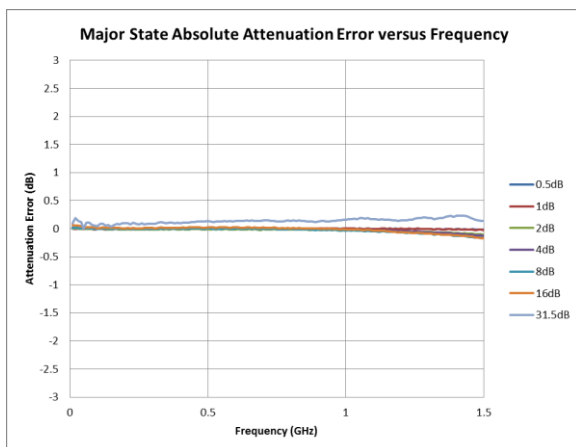
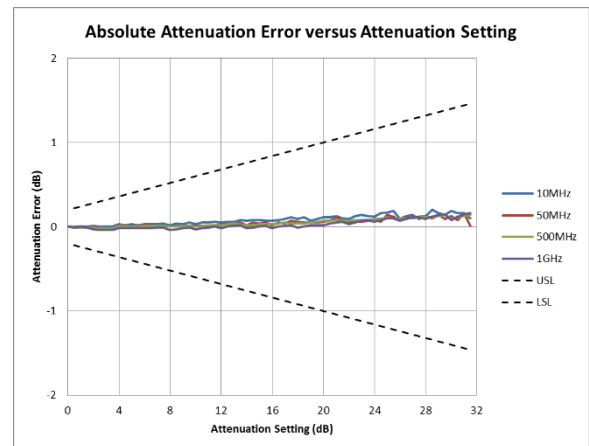
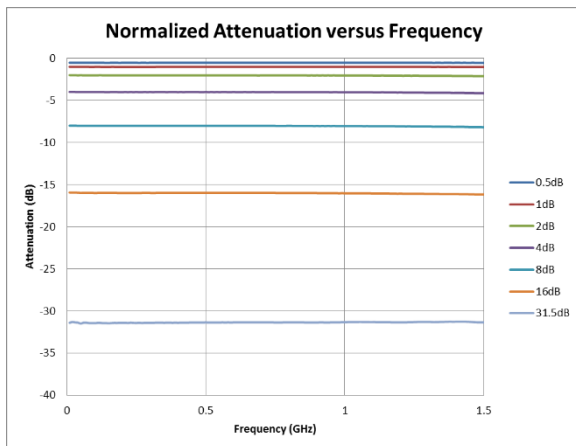
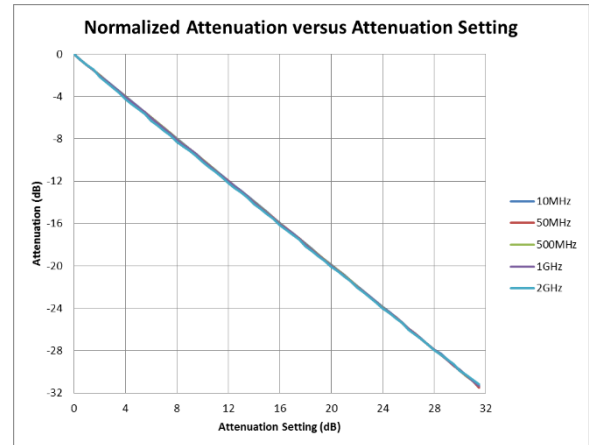
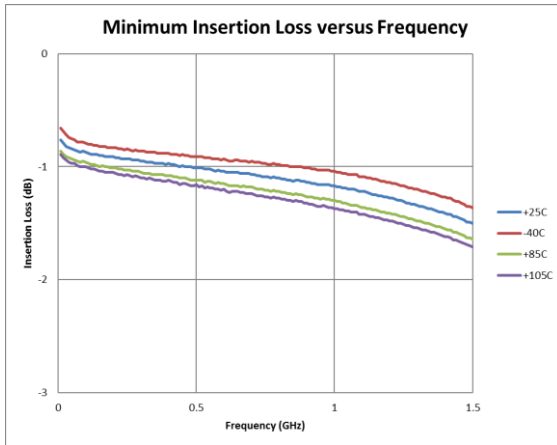

Performance Plots (cont'd.)

Test conditions unless otherwise noted: $V_{DD} = +5V$, $V_{SS} = 0V$ Temp = $+25^{\circ}C$, $Z_0 = 75\Omega$

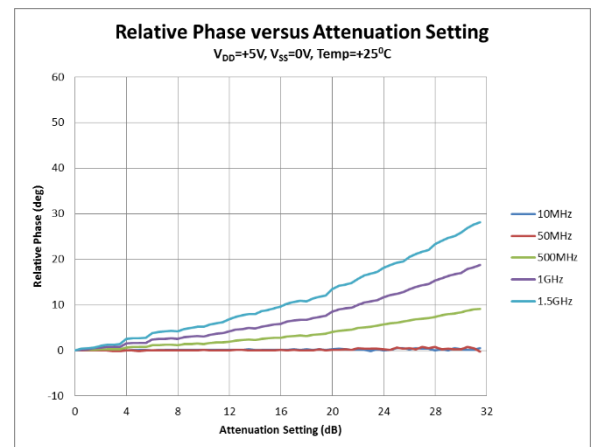
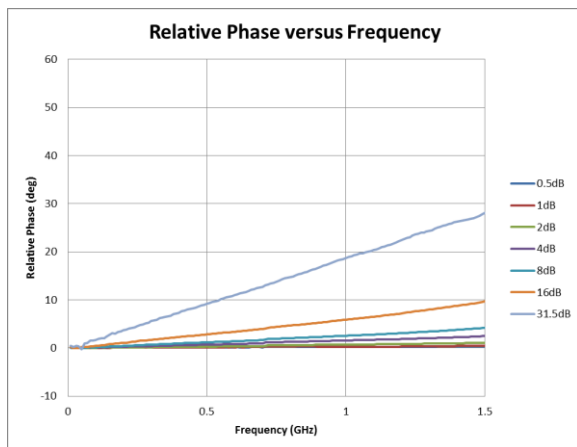
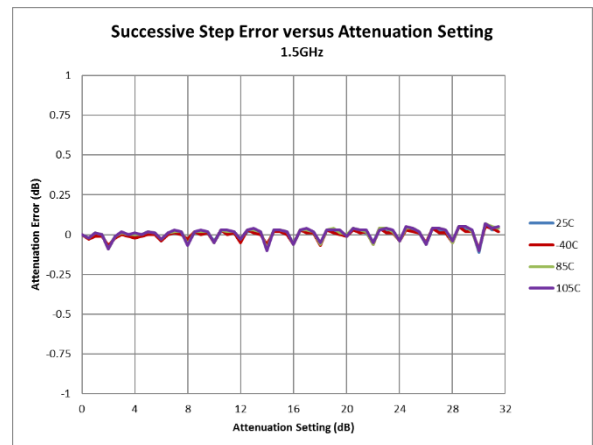
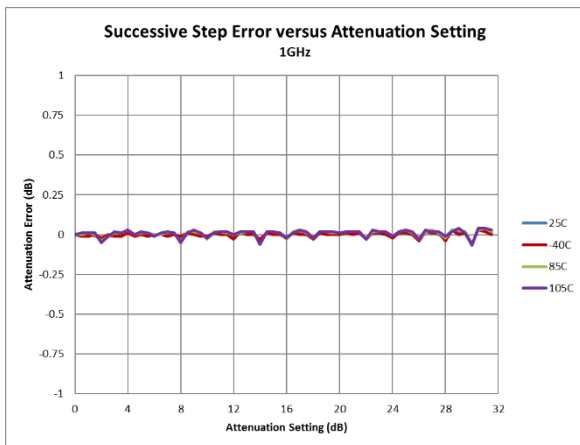
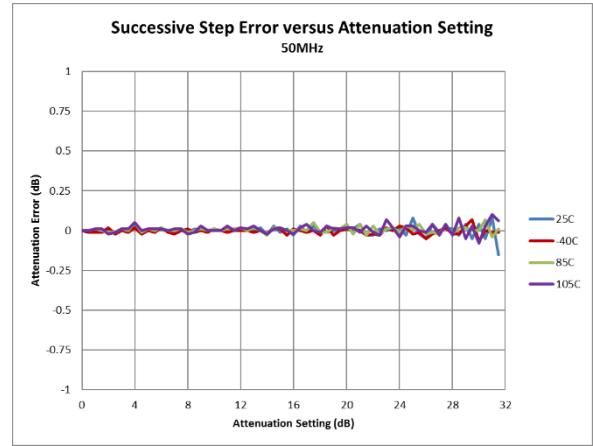
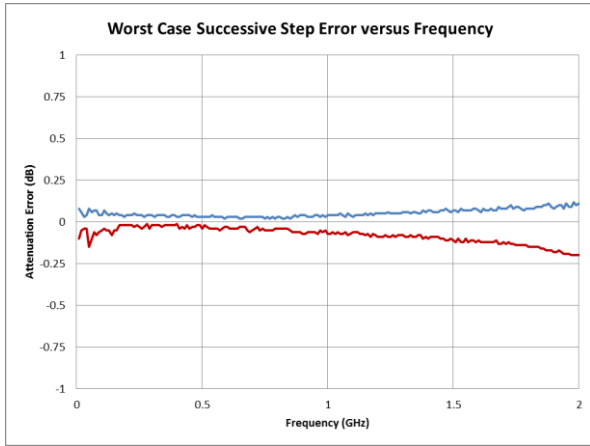

Performance Plots (cont'd.)

Test conditions unless otherwise noted: $V_{DD} = +5V$, $V_{SS} = 0V$ Temp = $+25^{\circ}C$, $Z_0 = 75\Omega$

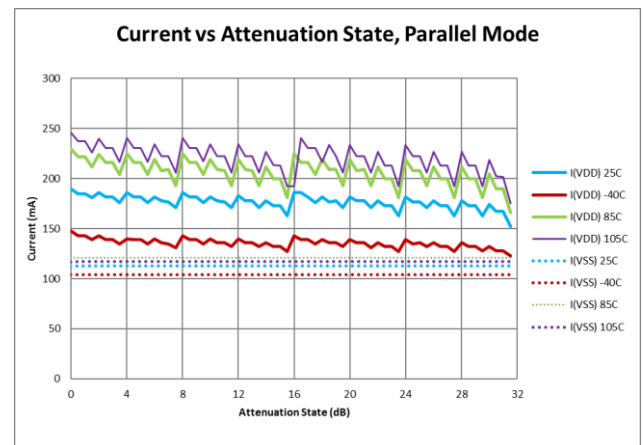
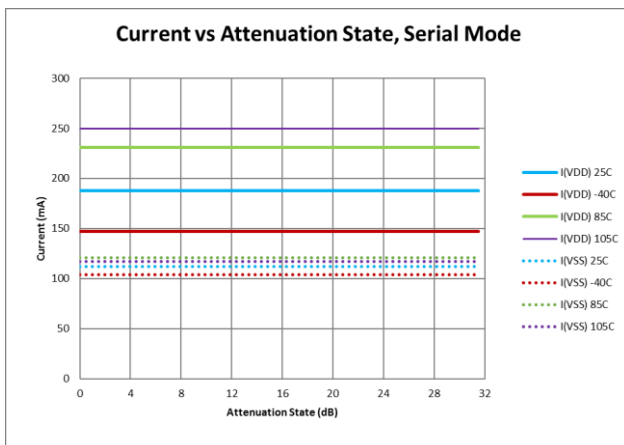
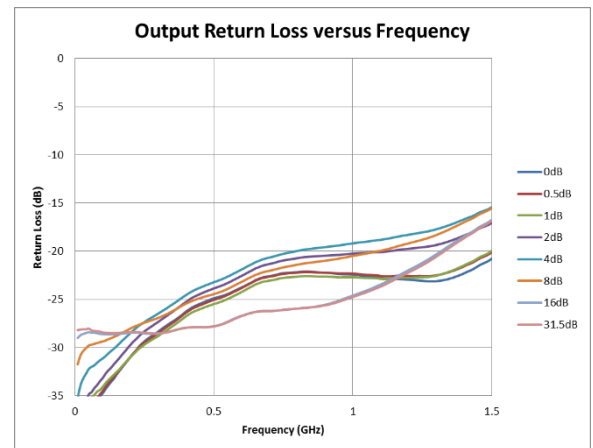
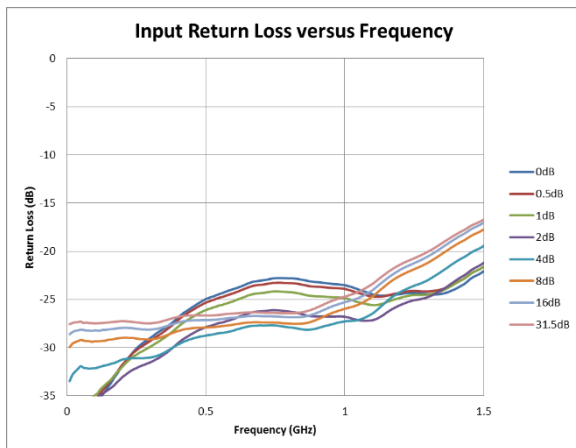
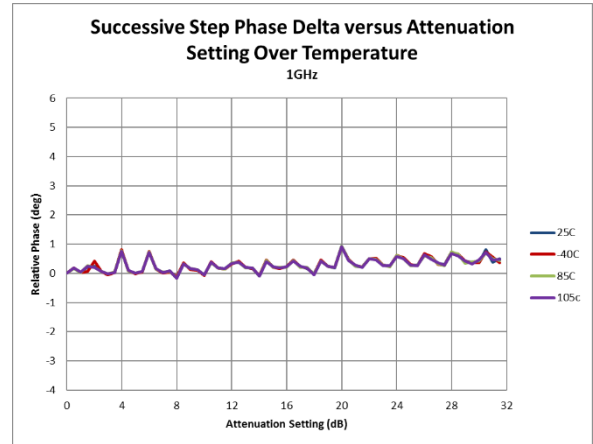
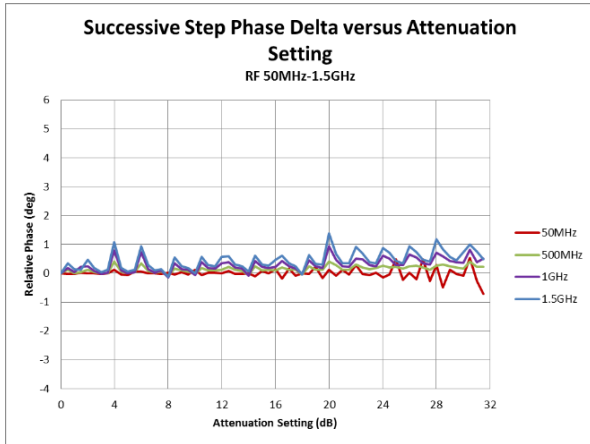

Performance Plots (cont'd.)

Test conditions unless otherwise noted: $V_{DD} = +5V$, $V_{SS} = 0V$ Temp = $+25^{\circ}C$, $Z_o = 75\Omega$

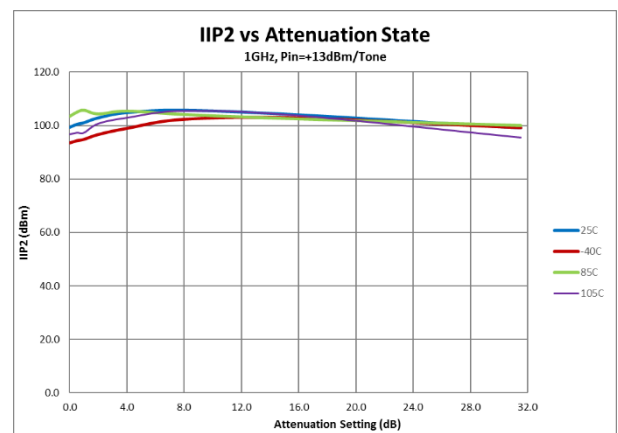
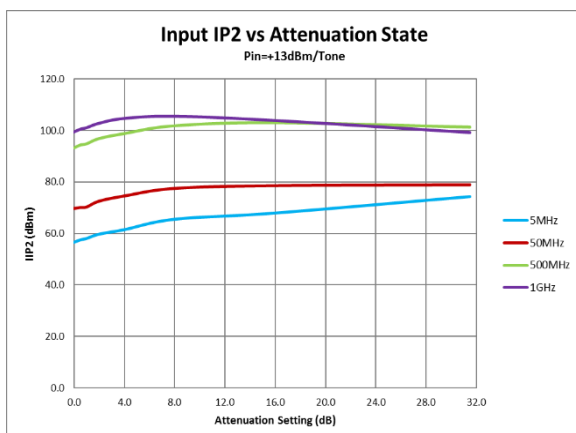
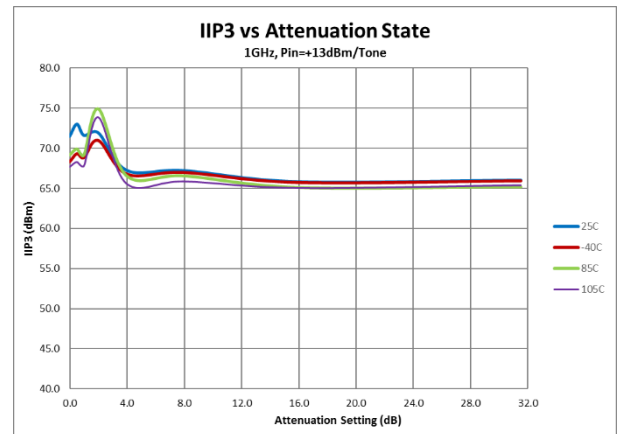
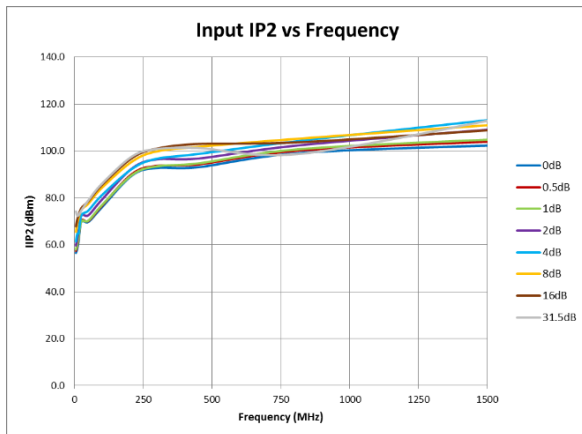
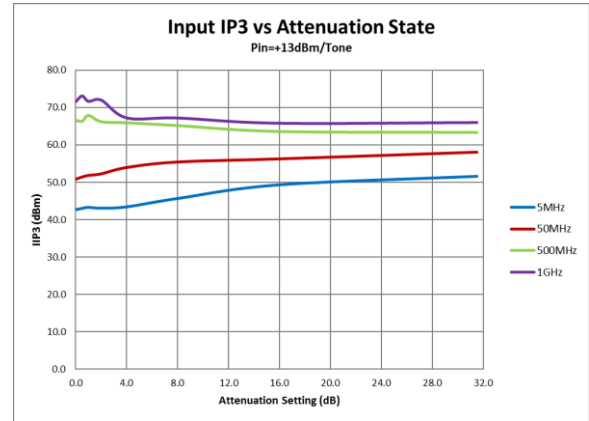
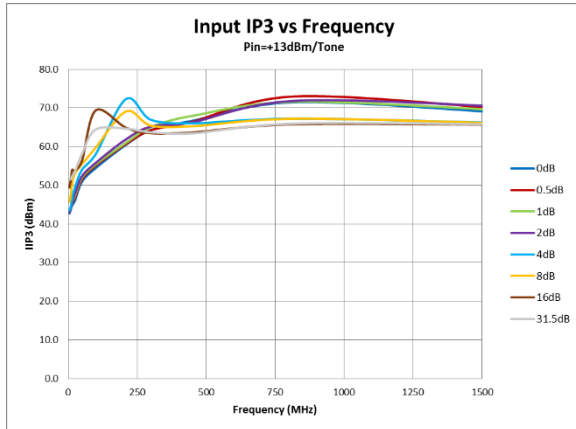

Performance Plots (cont'd.)

Test conditions unless otherwise noted: $V_{DD} = +5V$, $V_{SS} = 0V$ Temp = $+25^{\circ}C$, $Z_0 = 75\Omega$

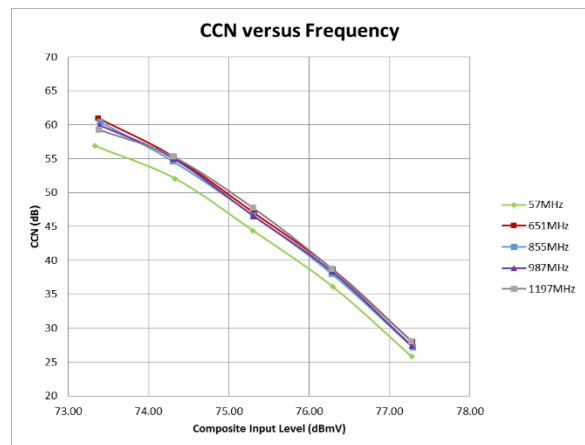
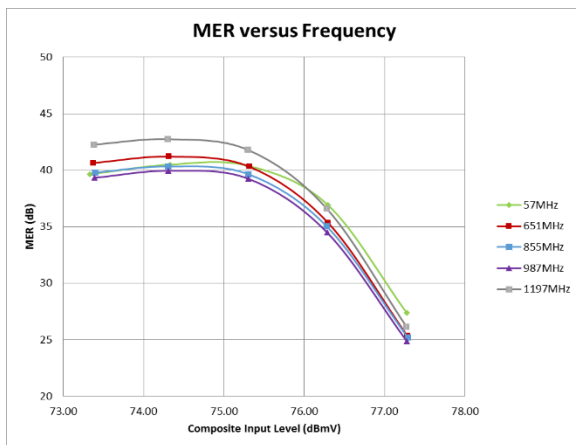
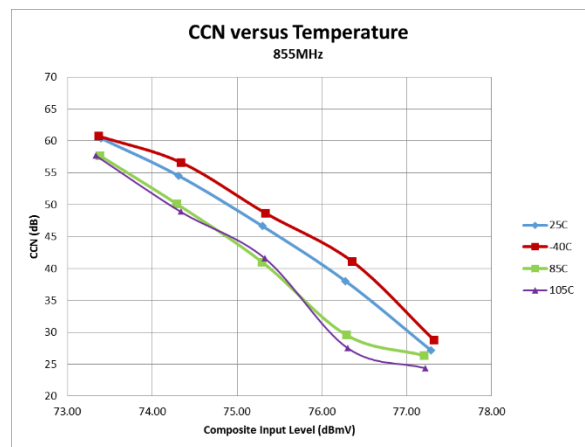
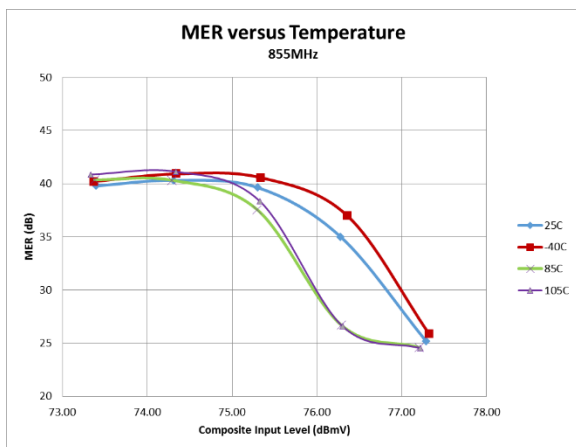
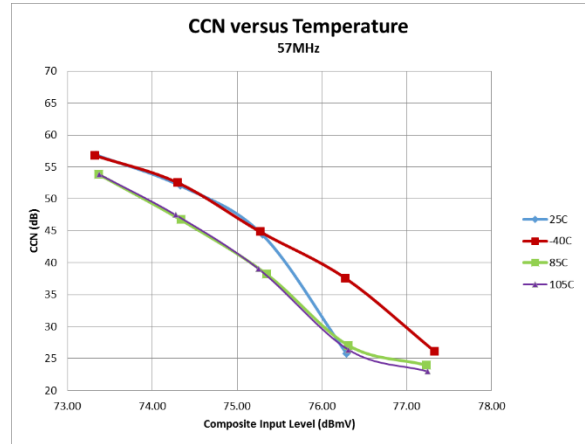
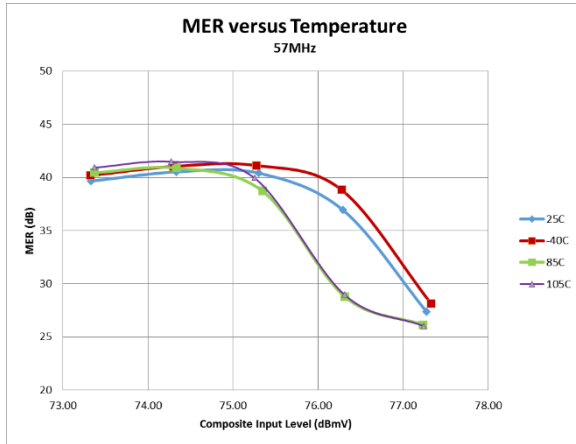

MER/CCN Test Conditions:

1. 190 QAM256 Channels, 57-1215MHz, ITU-T J.83, Annex B
2. CCN test procedure according to ANSI/SCTE 17. System BW 5.36MHz.
3. 0dB Attenuation Setting

Evaluation Board Programming Using USB Interface

Serial Mode

All programming jumpers on the evaluation board are set to the default values indicated in the table. Refer to the Control Bit Generator (CBG) Software Reference Manual for instructions on how to setup the software for use. Apply supply voltage to P6. Select 'QPC3614' for serial operation from the parts list of the CBG user interface. Set the attenuation value using the CBG user interface.

Direct Parallel Mode

Evaluation board programming jumper S2 is set to '0'. Refer to the Control Bit Generator (CBG) Software Reference Manual for instructions on how to setup the software for use. Apply the supply voltage to P6. Select 'QPC3614-P' from the parts list of the CBG user interface. Set the attenuation value using the CBG user interface.

Evaluation Board Programming Using External Bus

Serial Mode

This configuration allows the user to control the attenuator through the P5 connector using an external harness. Remove the USB interface board if it is currently installed on the evaluation board. Connect a user-supplied harness to the P5 connector. Note that the top row of P5 contains the serial bus signals and the bottom row is ground. Programming jumper S2 is set to '1' to select serial mode. Jumper S6 is installed and allows the LE signal to be routed from the P5 connector to the attenuator. Apply the supply voltage to P6. Send the appropriate signals onto the serial bus lines in accordance with the Serial Addressable Mode Timing Diagram.

Latched Parallel Mode

This configuration allows the user to control the attenuator through the P1 connector using an external harness. Remove the USB interface if it is currently installed on the evaluation board. Connect a user-supplied harness to the P1 connector. The parallel bus signal names for P1 are indicated on the evaluation board. Programming jumper S2 is set to '0' to select parallel mode. Apply the supply voltage to P6. Send the appropriate signals onto the parallel bus lines in accordance with the Latched Parallel Mode Timing Diagram.

Direct Parallel Mode

This configuration allows the user to control the attenuator through the P1 connector using an external harness. When using this mode the LE signal is held at logic high so that the attenuation will change immediately when there is a change in logic state for any of the parallel bus signals. Remove the USB interface if it is currently installed on the evaluation board. Connect a user-supplied harness to the P1 connector. The parallel bus signal names for P1 are indicated on the evaluation board. Programming jumper S2 is set to '0' to select parallel mode. Apply the supply voltage to P6. Send the appropriate signals onto the parallel bus lines.

Default Power-up State

This default attenuation state is maximum (31.5 dB) when supply voltage is applied to the attenuator in both serial and parallel modes. If a different attenuation state is desired during power-up, apply signals according to the Parallel Mode Truth Table to the C0.5 – C16 pins. The attenuator will power-up to the state applied to the parallel bus during turn on. The LE signal must be held to logic '0' during power-up. Note that the FDTI USB controller module on the Qorvo EVB can hold the parallel pins to a different state during power up. Removing the plug in module will allow normal expected power default operation.

Pad Configuration and Description

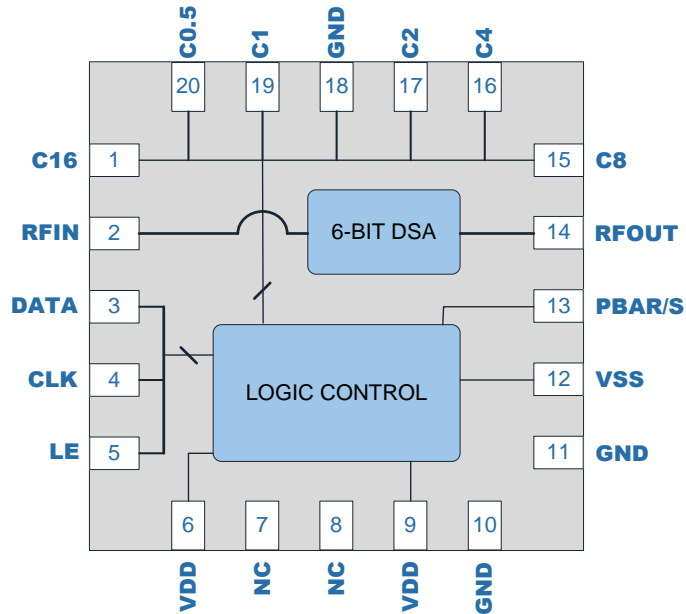

Top View

Pin	Label	Description
1	C16	16dB Parallel Control Bit
2	RFIN	RF Input Pin: Incident RF power must enter this pin for rated thermal performance and reliability. Do not apply DC power to this pin. Pin may be DC grounded externally and is grounded through resistors.
3	DATA	Serial Bus Data Input
4	CLK	Serial Bus Clock Input
5	LE	Latch Enable: The leading edge of signal on LE causes the attenuator to change state for serial and latched parallel modes. For direct parallel mode keep LE at logic high level.
6	VDD	Supply Voltage
7	NC	No Connection
8	NC	No Connection
9	VDD	Supply Voltage
10	GND	Ground Pin
11	GND	Ground Pin
12	VSS	External Negative Supply Voltage. Ground VSS pin to use internal negative voltage generator
13	PBAR/S	Mode Select Pin, Logic Low = Parallel, Logic High = Serial
14	RFOUT	RF Output Pin: Pin may be DC grounded externally and is grounded thru resistors internal to the part.
15	C8	8dB Parallel Control Bit
16	C4	4dB Parallel Control Bit
17	C2	2dB Parallel Control Bit
18	GND	Ground Pin
19	C1	1dB Parallel Control Bit
20	C0.5	0.5dB Parallel Control Bit
Backside Paddle	RF/DC GND	RF/DC ground. Use recommended via pattern to minimize inductance and thermal resistance. See PCB Mounting Pattern for suggested footprint.

Serial Mode Attenuation Word Truth Table

Attenuation Word							Attenuation State
D5	D4	D3	D2	D1	D0 (LSB)		
L	L	L	L	L	L	L	0 dB / Reference Insertion Loss
L	L	L	L	L	L	H	0.5 dB
L	L	L	L	L	H	L	1 dB
L	L	L	H	L	L	L	2 dB
L	L	H	L	L	L	L	4 dB
L	H	L	L	L	L	L	8 dB
H	L	L	L	L	L	L	16 dB
H	H	H	H	H	H	H	31.5 dB

Parallel Mode Attenuation Word Truth Table

Attenuation Word							Attenuation State
C16	C8	C4	C2	C1	C0.5 (LSB)		
L	L	L	L	L	L	L	0 dB / Reference Insertion Loss
L	L	L	L	L	L	H	0.5 dB
L	L	L	L	H	L	L	1 dB
L	L	L	H	L	L	L	2 dB
L	L	H	L	L	L	L	4 dB
L	H	L	L	L	L	L	8 dB
H	L	L	L	L	L	L	16 dB
H	H	H	H	H	H	H	31.5dB

Serial Mode Timing Diagram

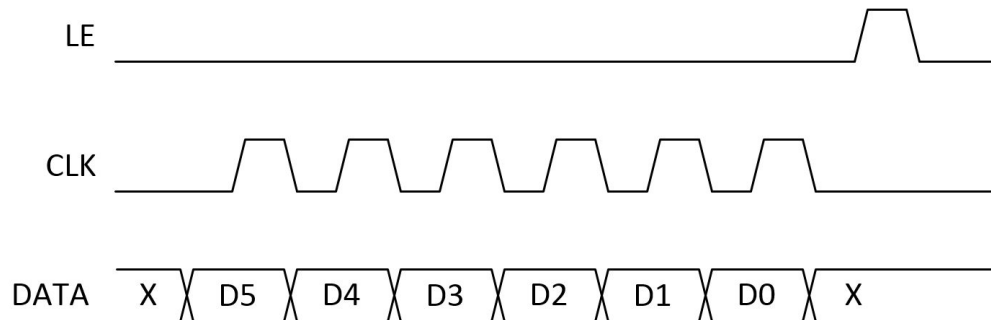

Latched Parallel Mode Timing Diagram

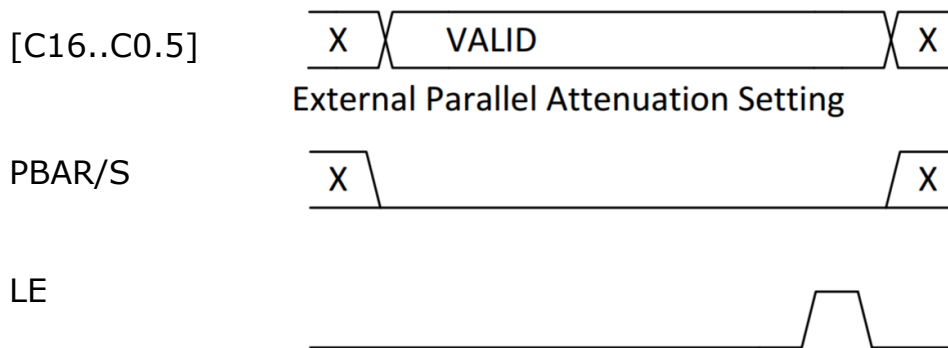

Serial BUS Timing Specifications

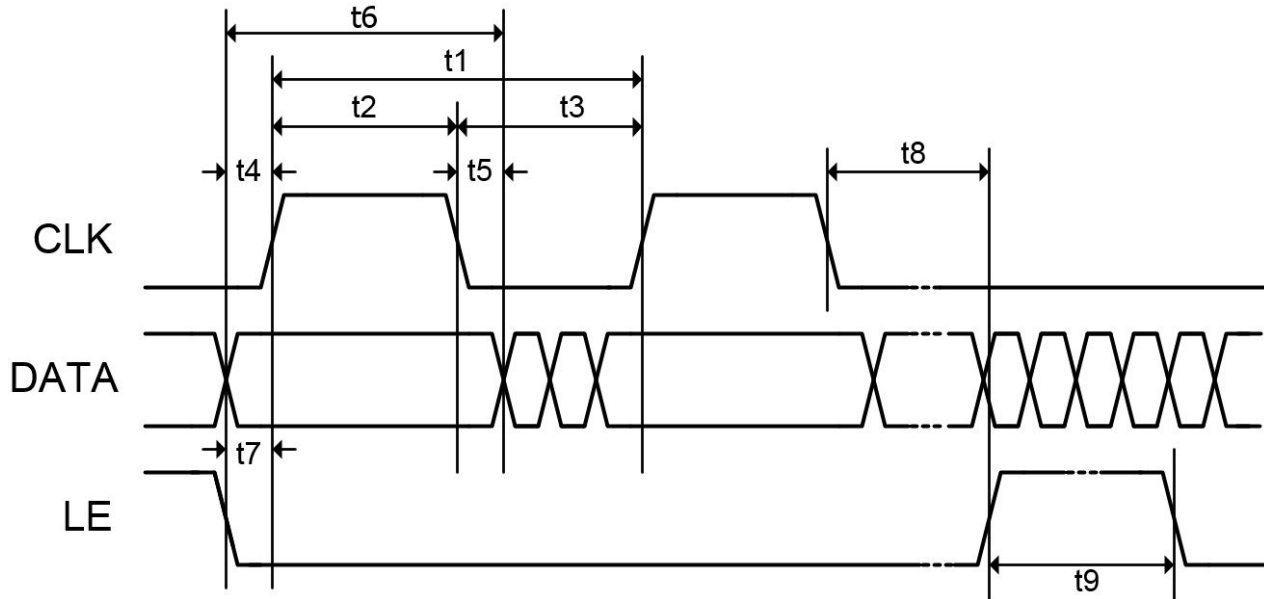

Parameter	Limit	Unit	Comment
t1	25	MHz max	CLK Frequency
t2	20	ns min	CLK High
t3	20	ns min	CLK Low
t4	5	ns min	Data to CLK Setup Time
t5	5	ns min	Data to CLK Hold Time
t6	30	ns min	Data Valid
t7	5	ns min	LE to CLK Setup Time
t8	5	ns min	CLK to LE Setup Time
t9	10	ns min	LE Pulse Width

Package Marking

