

### Product Description

The QPC7335 is a voltage controlled variable equalizer employing SOI attenuator, optimized for DOCSIS 3.1 operation between 45MHz and 1002MHz.

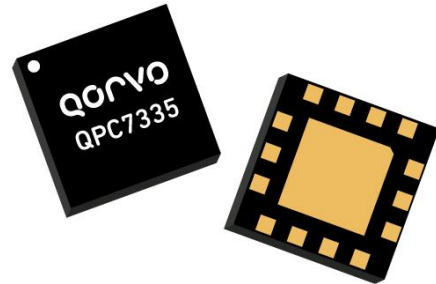

14 pin, 6.0 mm x 6.0 mm x 1.375 mm package

### Functional Block Diagram

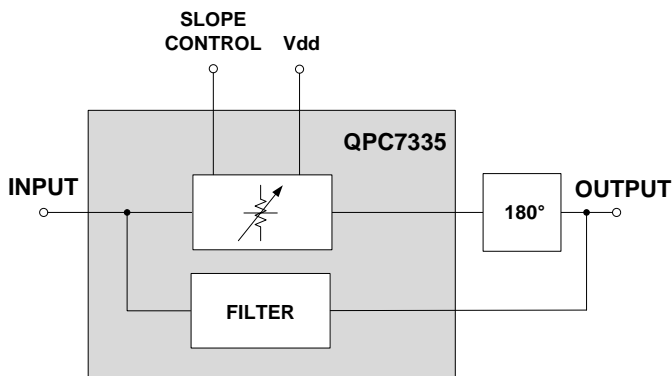

### Product Features

- 45 – 1002 MHz Operational Bandwidth
- 18dB slope range
- Low insertion loss
- High linearity
- 75Ohm impedance for CATV applications
- 5V single supply voltage
- Low power consumption

### Applications

CATV amplifier and transmission systems

### Ordering Information

Part No.	Description
QPC7335SB	Sample bag 5 pcs
QPC7335SR	7" Reel with 100 pcs
QPC7335TR7	7" Reel with 500 pcs
QPC7335PCBA-410	Fully assembled Evaluation Board

### Absolute Maximum Ratings

Parameter	Value / Range
Supply Voltage (Vdd)	-0.5 to +6V
Control Voltage (Vc)	-0.5 to +6V
Control Voltage 2 (Vc2)	-2 to +24V
MODE	-0.5 to +6V
Storage Temperature	-40 to 100 °C
RF Input Power	+30 dBm

Exceeding any one or a combination of the Absolute Maximum Rating conditions may cause permanent damage to the device. Extended application of Absolute Maximum Rating conditions to the device may reduce device reliability.

### Recommended Operating Conditions

Parameter	Min	Typ	Max	Units
Supply Voltage (Vdd)		+5		V
Junction Temperature			+125	°C
Operating Temperature	-30		+100	°C

Electrical specifications are measured at specified test conditions in application circuit. Specifications are not guaranteed over all recommended operating conditions.

### Electrical Specifications – Tested in Evaluation Circuit

Parameter	Conditions (Vdd=5V, T <sub>MB</sub> =25°C, Z <sub>S</sub> =Z <sub>L</sub> =75Ω)	Min	Typ	Max	Units
<b>General Performance</b>					
Supply Current (I <sub>dd</sub> )			3		mA
Thermal Resistance			70		K/W
RF Input Power				27	dBm
Frequency Range		45		1002	MHz
Minimum Slope [1]	f= 45 to 1002MHz		0.7		dB
Maximum Slope [1]	f= 45 to 1002MHz		20		dB
<b>RF Performance, slope set between 5dB and 15dB</b>					
Insertion Loss (S21)	f= 1002MHz		2.6	3.0	dB
Flatness [2]	f= 45 to 1002MHz		0.6		dB
Input Return Loss (S11)	f= 45 to 1002MHz		-17		dB
Output Return Loss (S22)	f= 45 to 1002MHz		-18		dB
Input IP3	P <sub>IN</sub> + (IM <sub>3dBc</sub> /2) 6MHz tone spacing at 15dBm/tone		50		dBm
Input IP2	P <sub>IN</sub> + IM <sub>2dBc</sub> , IM <sub>2</sub> is F1 + F2 6MHz tone spacing at 15dBm/tone		80		dBm
<b>RF Performance, slope set between 1dB and 22dB</b>					
Insertion Loss (S21)	f= 1002MHz		2.8		dB
Flatness [2]	f= 45 to 1002MHz		2		dB
Input Return Loss (S11)	f= 45 to 1002MHz		-16		dB
Output Return Loss (S22)	f= 45 to 1002MHz		-17		dB

Parameter	Conditions (Vdd=5V, T <sub>MB</sub> =25°C, Z <sub>S</sub> =Z <sub>L</sub> =75Ω)	Min	Typ	Max	Units
<b>Control</b>					
Control Voltage (Vc) [3], positive slope control gradient	MODE = 0V, minimum slope at Vc = 0V	0	1 to 3	5	V
Control Voltage (Vc) [3], negative slope control gradient	MODE = 5V, minimum slope at Vc = 5V	0	2 to 4	5	V
Control Voltage 2 (Vc2) [3], positive slope control gradient	MODE = 0V, minimum slope at Vc2 = 0V	0	4 to 12	20	V
Control Voltage 2 (Vc2) [3], negative slope control gradient	MODE = 5V, minimum slope at Vc2 = 20V	0	8 to 16	20	V
MODE Pin Logic Low				0.4	V
MODE Pin Logic High		1			V

Notes:

1. Slope is defined as the difference between the gain at the start frequency and the gain at the stop frequency.
2. Flatness is defined as sum of positive and negative deviation from a straight line between gain at start frequency and gain at stop frequency.
3. Either Vc or Vc2 can be used to set slope, internal 1:4 voltage divider between Vc and Vc2.

QPC7335 Slope vs. Frequency, typical

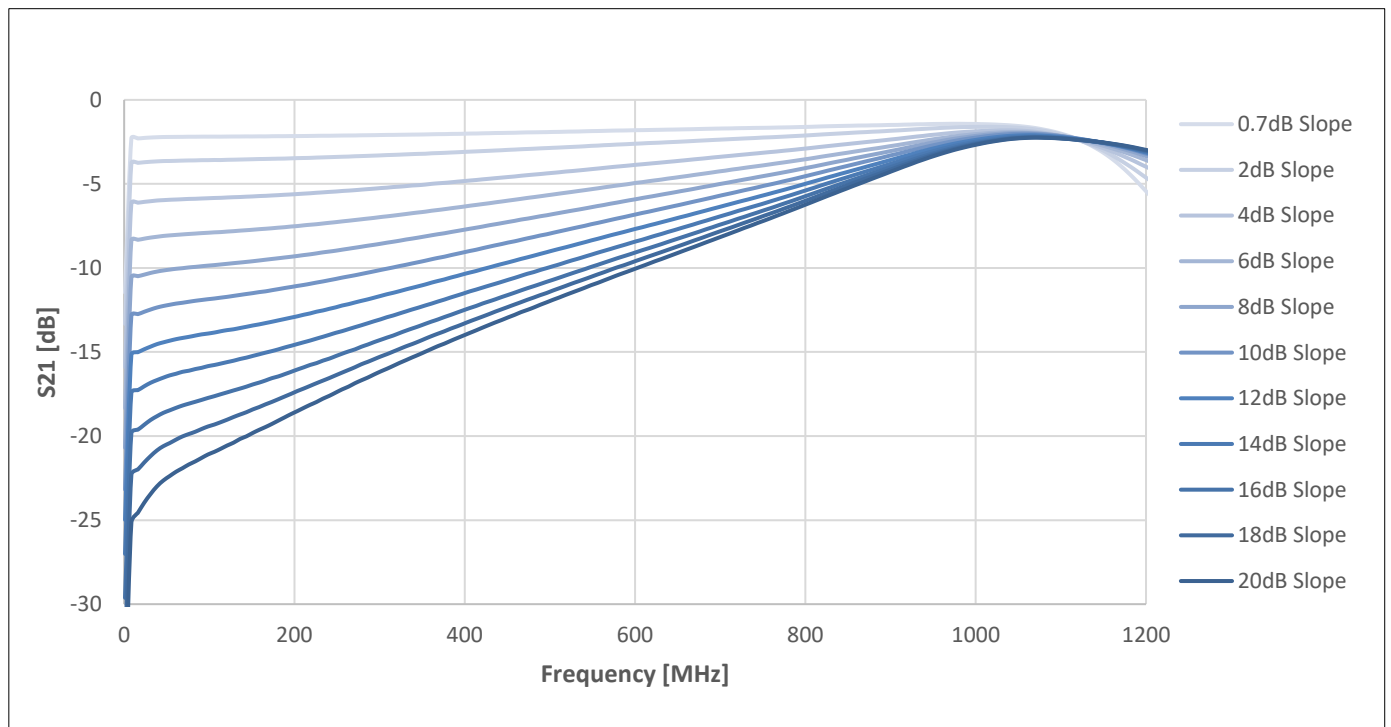

QPC7335 Input IP3 vs. Slope, typical

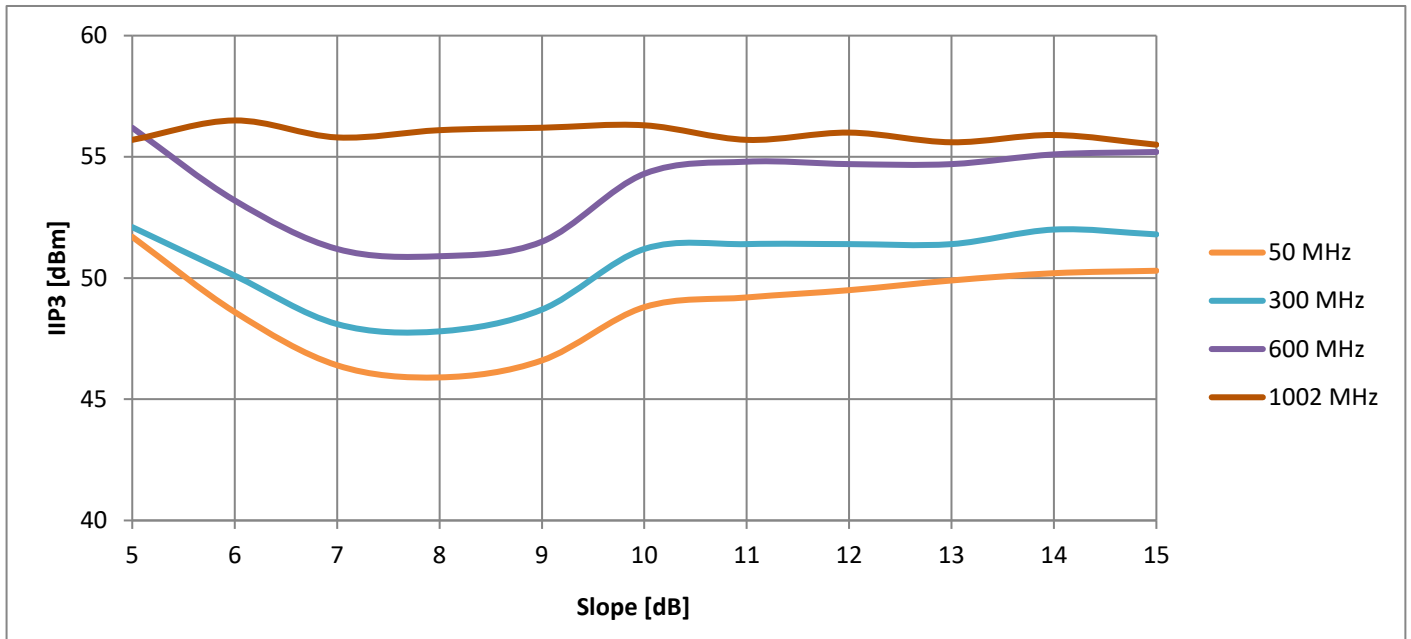

QPC7335 Flatness vs. Slope, typical

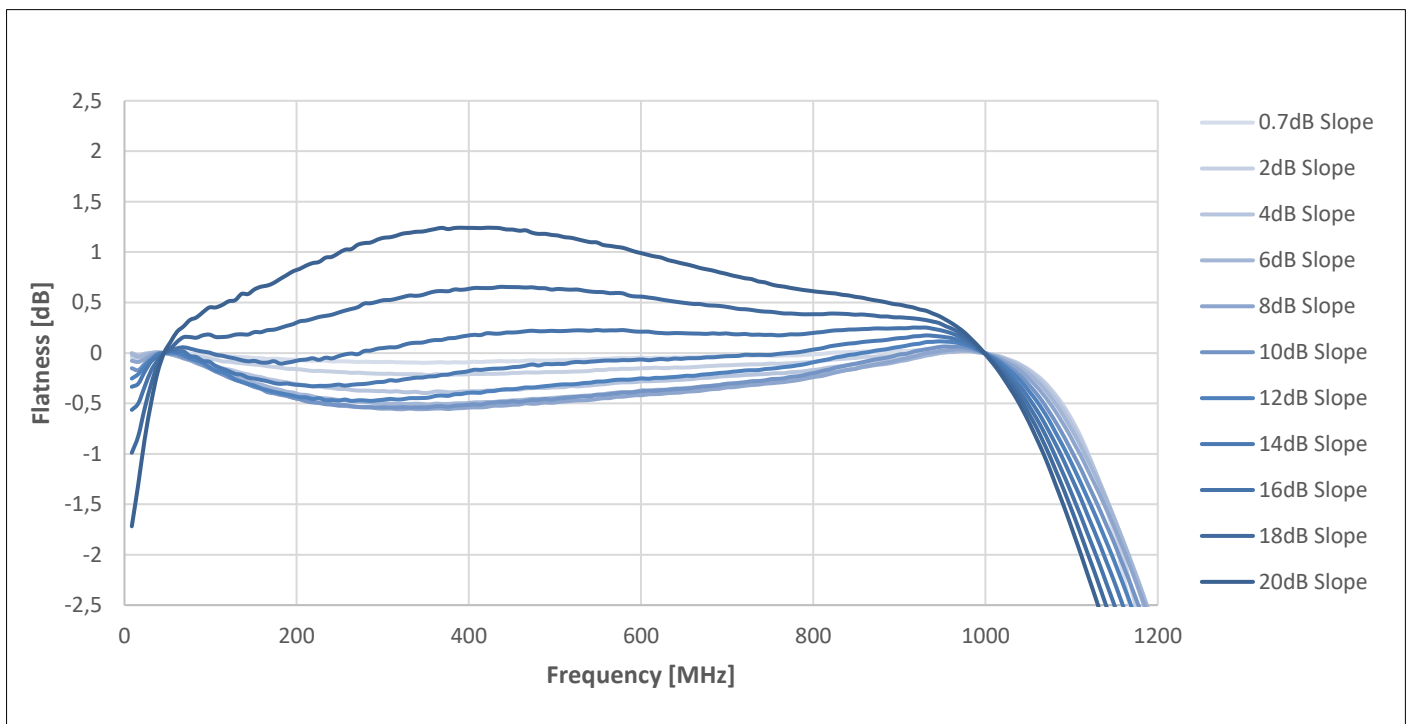

QPC7335 S11 vs. Slope, typical

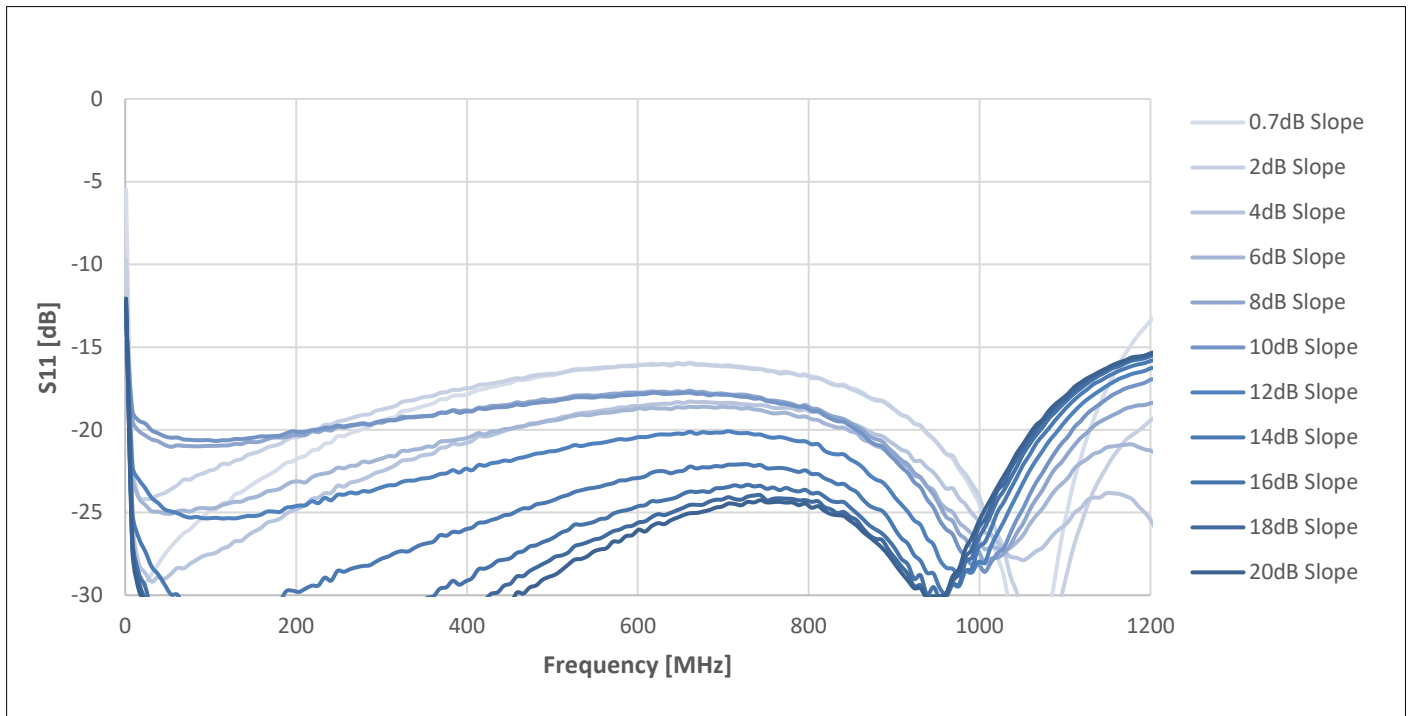

QPC7335 S22 vs. Slope, typical

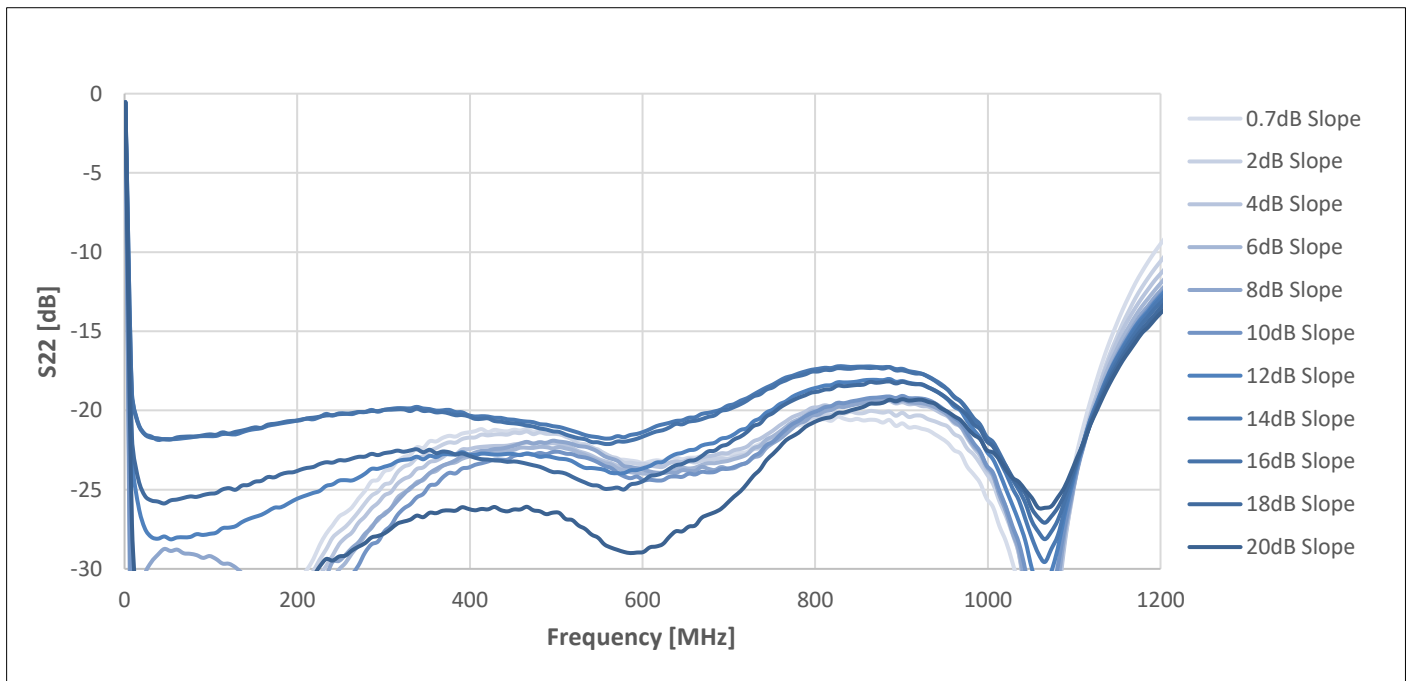

QPC7335 Slope vs. Vc, typical

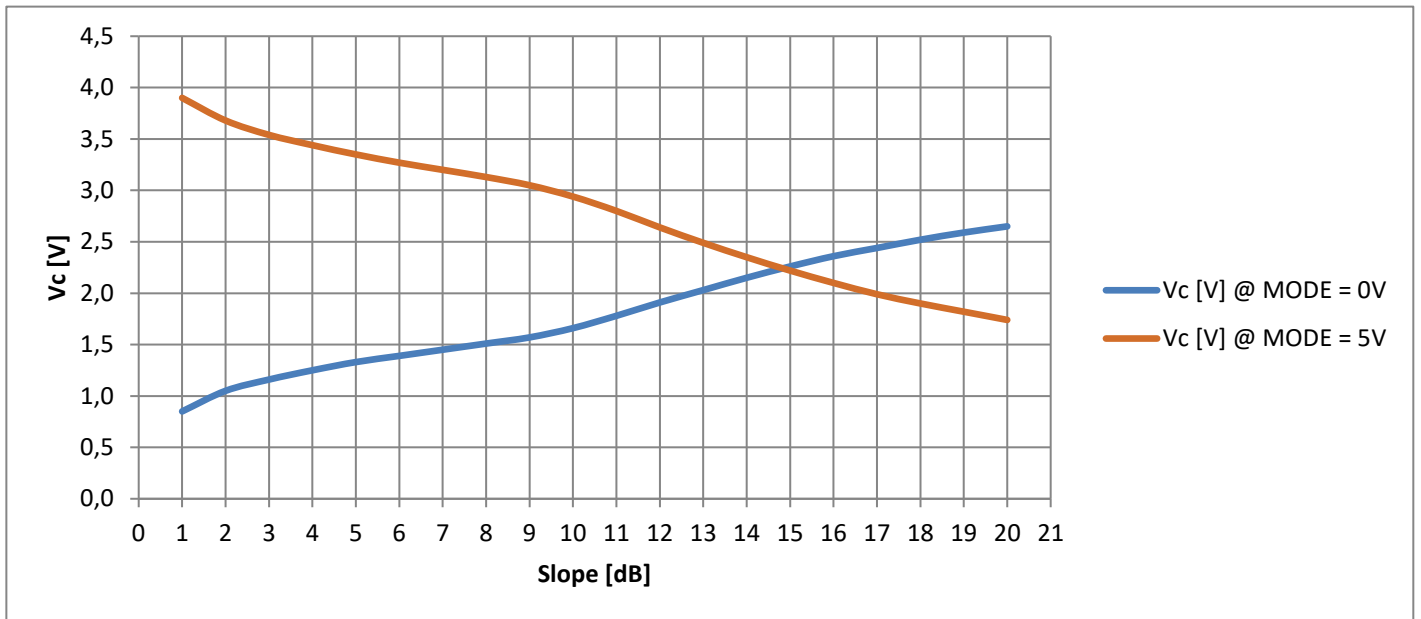

QPC7335 Slope vs. Vc2, typical

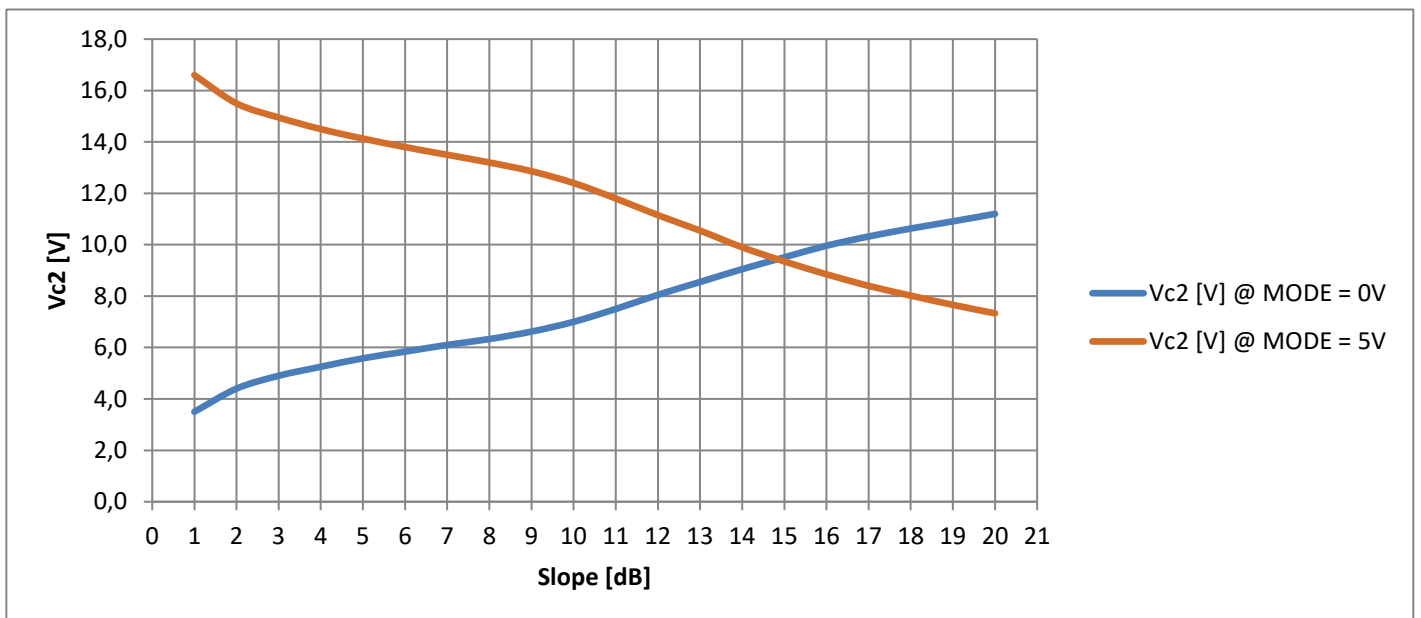

QPC7335 Slope vs. Temperature, typical

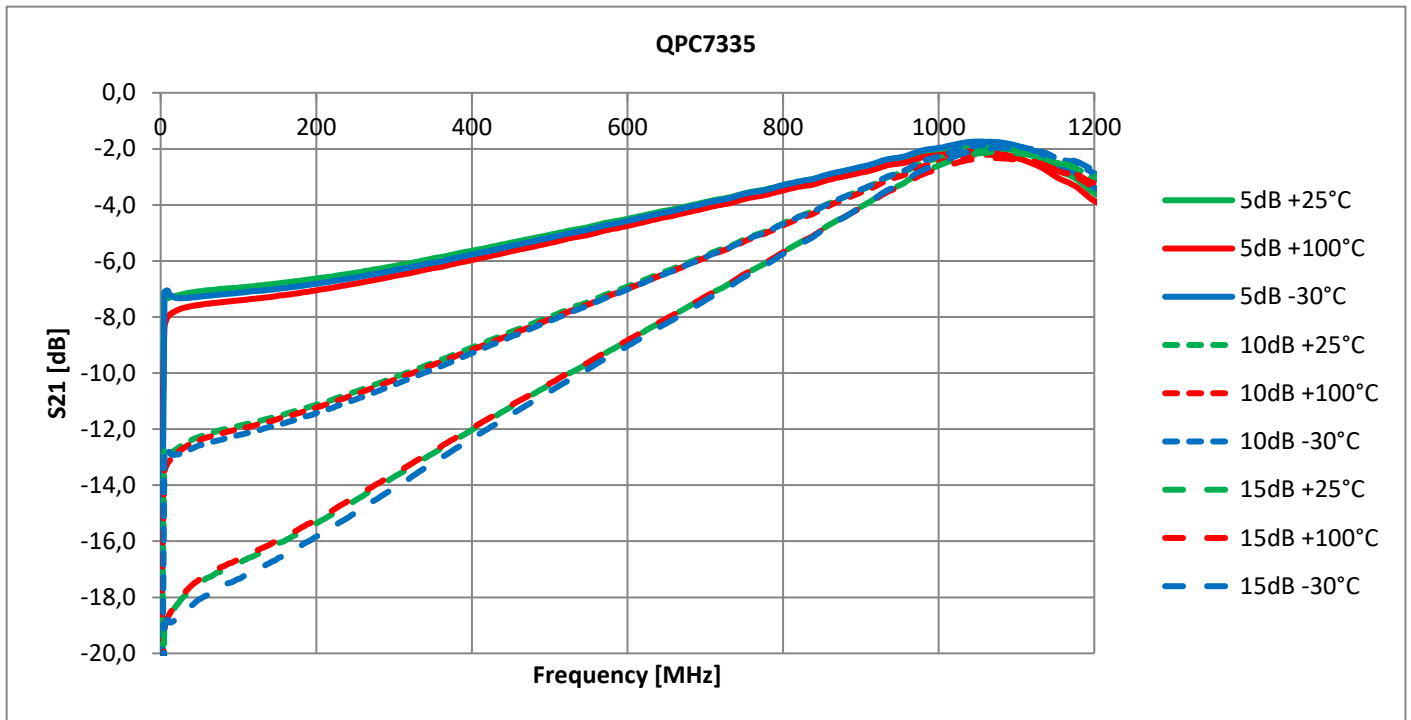

QPC7335 Input IP3 vs. Temperature, typical

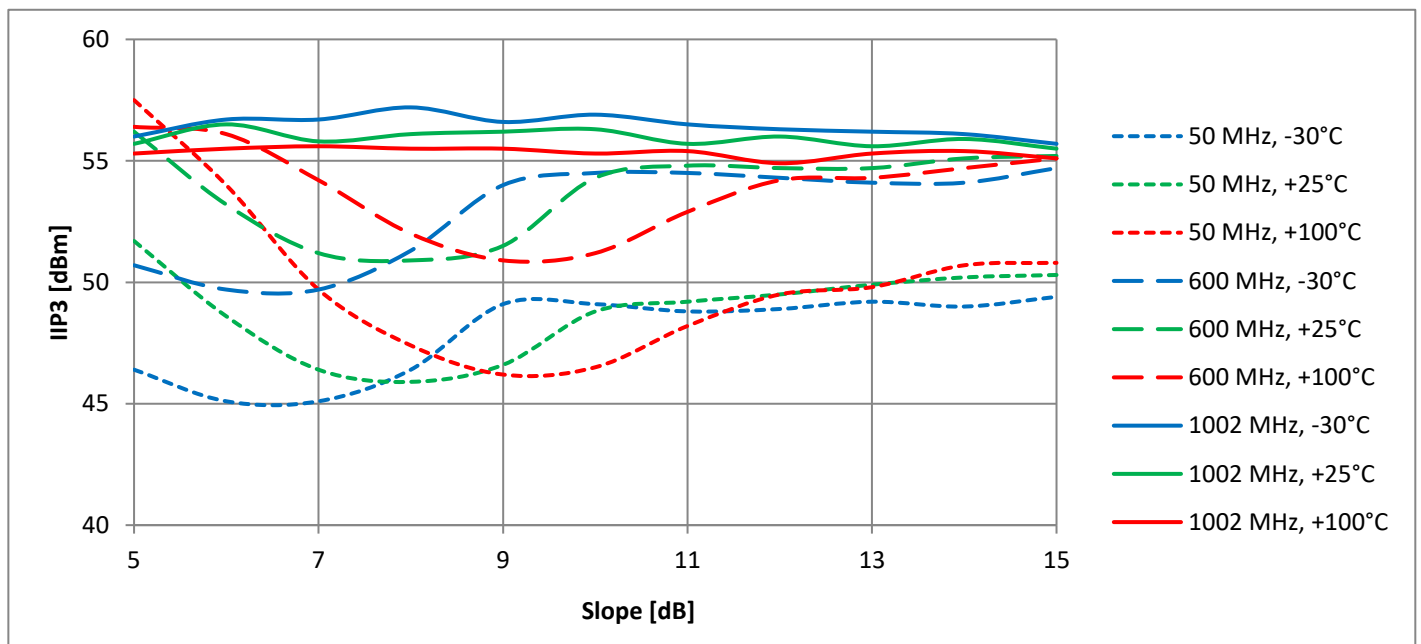

Evaluation Board Assembly Drawing

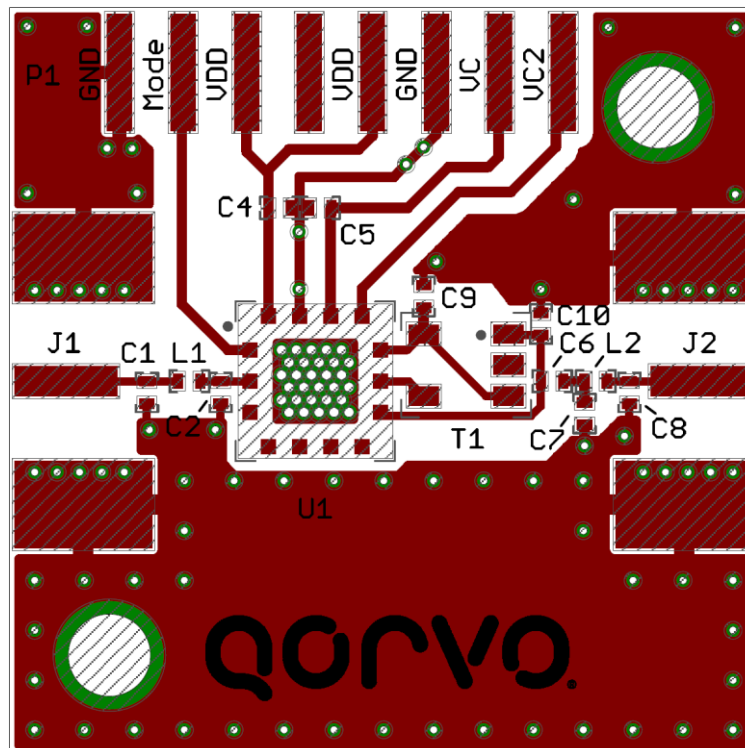

Evaluation board PCB: FR4, double sided, 1.5mm, 35um Cu

Vias are required under the backside paddle of this device for proper RF/DC grounding and thermal dissipation. A via drill diameter of 0.4mm and a minimum via wall copper plating thickness of 25um is recommended. Open vias are preferred to allow flux and gases to escape during reflow soldering and therefore to minimize voiding. Ensure good package backside paddle solder attach for reliable operation and best electrical performance. In any case the module backside temperature should not exceed 110 °C.



**Evaluation Board Schematic**

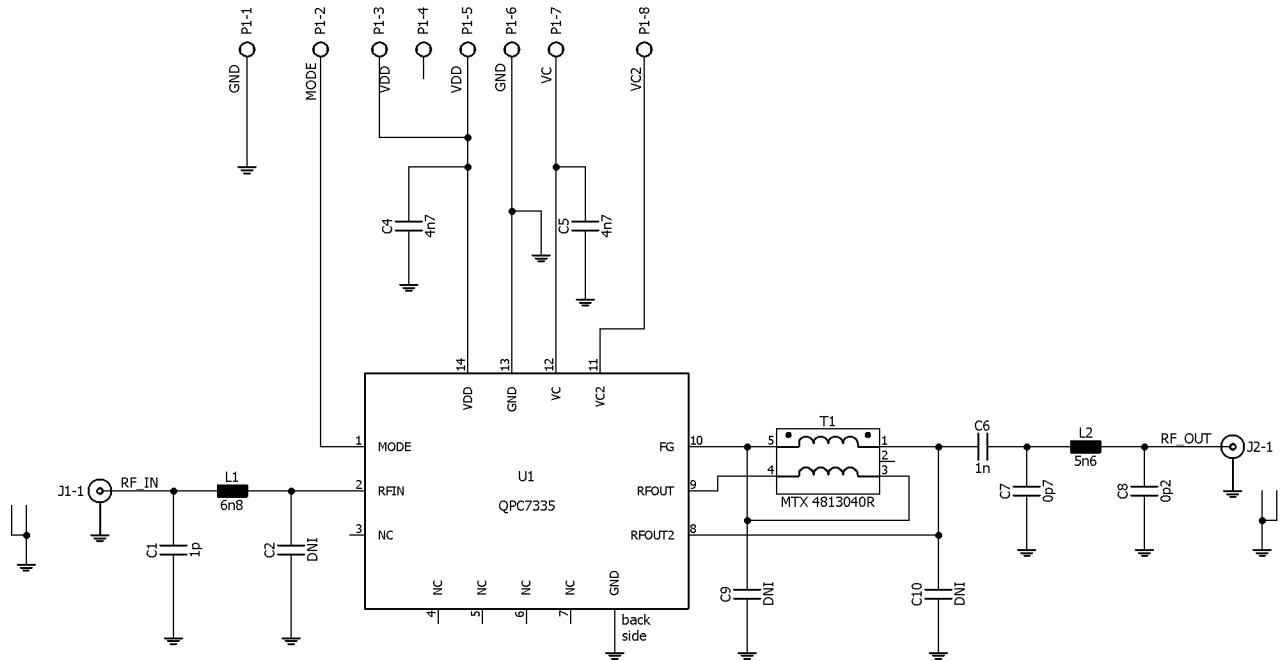

**Evaluation Board Bill of Materials (BOM)**

Ref. Designator	Value, package	Description	Manufacturer	Part Number
C1	1pF, C0G, 0402	Chip capacitor	MURATA, TAIYO YUDEN	
C2, C9, C10	DNI			
C4, C5	4.7nF, X7R, 0402	Chip capacitor	MURATA, TAIYO YUDEN	
C6	1nF, X7R, 0402	Chip capacitor	MURATA, TAIYO YUDEN	
C7	0.7pF, C0G, 0402	Chip capacitor	MURATA, TAIYO YUDEN	
C8	0.2pF, C0G, 0402	Chip capacitor	MURATA, TAIYO YUDEN	
L1	6.8nH, 0402	Chip inductor	TAIYO YUDEN	HK 1005 5N6S
L2	5.6nH, 0402	Chip inductor	TAIYO YUDEN	HK 1005 6N8J
T1		Transformer	Minntronix	4813040R
J1, J2		Connector F-type, female	Amphenol	222181
P1		Connector, 2.54mm pin spacing, optional	various	
U1		Variable equalizer	QORVO	QPC7335

Notes: C1, L1, C2, C7, L2 and C8 may be modified in target application circuit for S11 and S22 optimization  
 T1 alternative part: Mini RF MRFRX0032, S11 and S22 may show degradation

## Pin Configuration

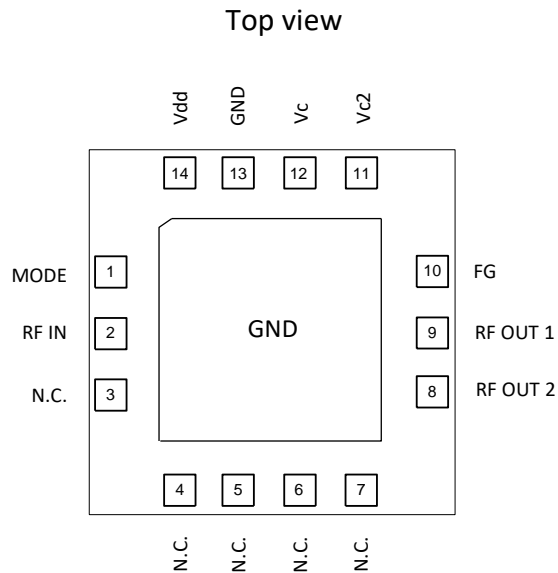

## Pin Description

Pin No.	Label	Description
1	MODE	Slope control gradient (0V: positive slope control gradient or 5V: negative slope control gradient)
2	RF IN	RF input signal, AC coupled
8	RF OUT 2	Connection to balun and circuit output
9	RF OUT 1	Connection to balun
10	FG	Floating ground, connection to balun
11	Vc2	Control voltage 2
12	Vc	Control voltage
13, GND	GND	Ground
14	Vdd	+5V supply voltage
3, 4, 5, 6, 7	N.C.	Not connected

Notes: Either Pin11 or Pin12 can be used to set slope, internal 1:4 voltage divider between Pin11 and Pin12

Package Outline Drawing (Dimensions in millimeters)

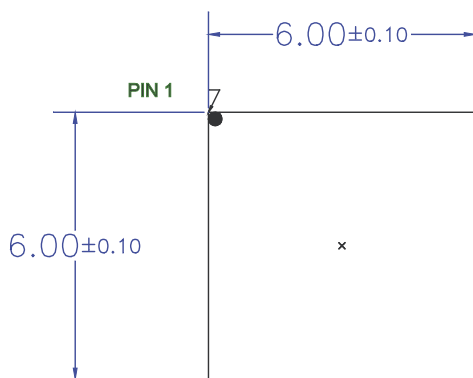

TOP VIEW

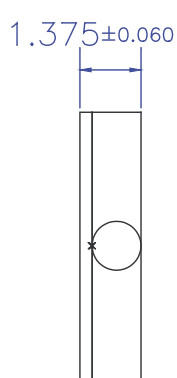

SIDE VIEW

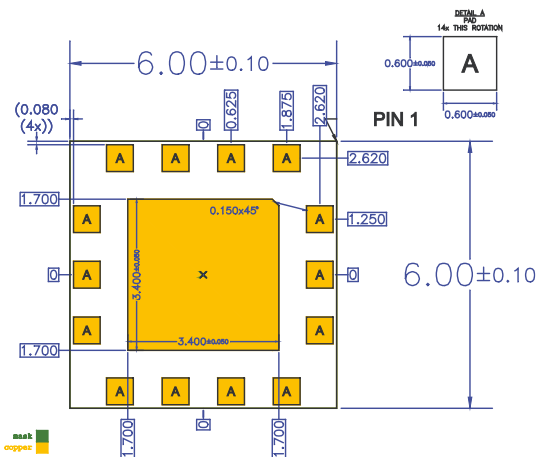

BOTTOM VIEW

Notes:

1. Dimension and tolerance formats conform to ASME Y14.5M-1994.
2. The terminal #1 identifier and terminal numbering conform to JESD 95-1 SPP-012.
3. Co-planarity applies to the exposed ground/thermal pad as well as the contact pins.
4. Package body length/width does not include plastic flash protrusion across mold parting line.

PCB Metal Land Pattern (Dimensions in millimeters)

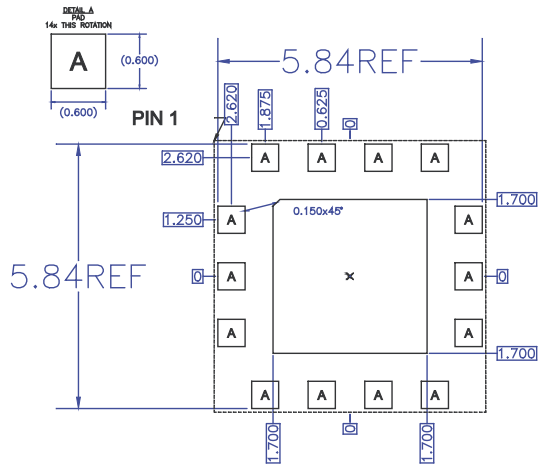

**RECOMMENDED  
LAND PATTERN**

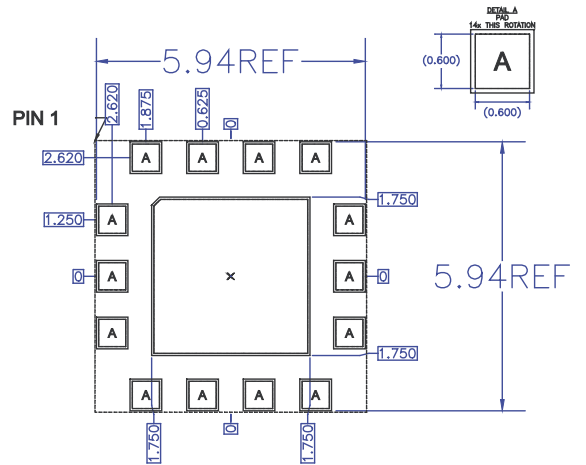

**RECOMMENDED  
LAND PATTERN MASK**

Notes:

1. All dimensions are in millimeters. Angles are in degrees.