

Product Overview

The QPD0060 is a wide band plastic overmolded DFN discrete power amplifier. The device is a single stage unmatched power amplifier transistor.

The QPD0060 can be used in Doherty architecture for the final stage of a base station amplifier for small cell, microcell, and active antenna systems. The QPD0060 can also be used as a driver in a macrocell base station power amplifier.

The wide bandwidth of the QPD0060 makes it suitable for many different applications from DC to 2.7 GHz. QPD0060 can deliver P_{SAT} of 89.1 W at +48 V operation at 2.1 GHz.

Lead-free and RoHS compliant.



6 Pin 7.2 x 6.6 mm DFN Package

Key Features

- Operating Frequency Range: DC to 2.7 GHz
- Operating Drain Voltage: +48 V
- Maximum Output Power (P_{SAT}): 89.1 W ⁽¹⁾
- Maximum Drain Efficiency: 74.7% ⁽¹⁾
- Efficiency-Tuned P3dB Gain: 21.5 dB ⁽¹⁾
- Surface Mount Plastic Package

Notes:

1. Load pull performance at 2.1 GHz.

Functional Block Diagram

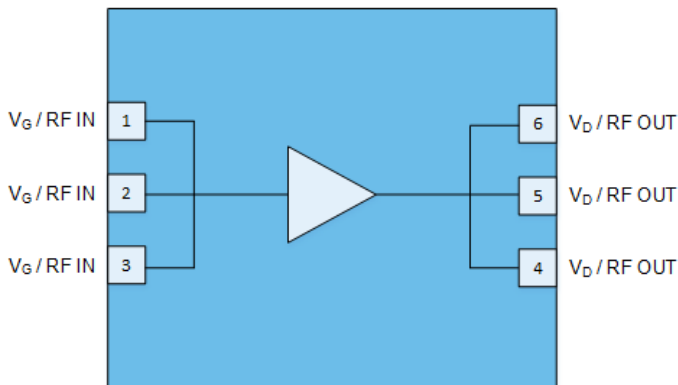

Applications

- W-CDMA / LTE
- Macrocell Base Station Driver
- Microcell Base Station
- Small Cell Final Stage
- Active Antenna
- General Purpose Applications

Ordering Information

Part Number	Description
QPD0060SR	Short Reel – 100 Pieces
QPD0060TR7	7" Reel – 500 pieces
QPD0060PCB4B01	1.8 – 2.2 GHz Evaluation Board
QPD0060EVB01	762 – 944 MHz Evaluation Board

Absolute Maximum Ratings

Parameter	Rating
Breakdown Voltage (V_{BDG})	+165 V
Gate Voltage Range (V_G)	-7 to +2 V
Drain Voltage (V_D)	+55 V
Peak RF Input Power	38 dBm
VSWR Mismatch, P1dB Pulse (20% Duty Cycle, 100 μ s Width), $T = +25^\circ\text{C}$	10:1

Exceeding any one or a combination of the Absolute Maximum Rating conditions may cause permanent damage to the device. Extended application of Absolute Maximum Rating conditions to the device may reduce device reliability.

Recommended Operating Conditions

Parameter	Min	Typ	Max	Units
Gate Voltage (V_G)		-2.7		V
Drain Voltage (V_D)		+48		V
Quiescent Drain Current (I_{DQ})		130		mA

Electrical specifications are measured at specified test conditions. Specifications are not guaranteed over all recommended operating conditions.

Electrical Specifications

Parameter	Conditions	Min	Typ	Max	Units
Operational Frequency Range		1800		2200	MHz
Quiescent Drain Current (I_{DQ})			130		mA
Gain	3 dB Compression	14.7	16.4		dB
Power (P_{SAT})	3 dB Compression	48.1	49.8		dBm
Drain Efficiency	3 dB Compression	60.0	69.2		%

Test conditions unless otherwise noted: $V_D = +48\text{ V}$, $I_{DQ} = 130\text{ mA}$, $T = +25^\circ\text{C}$, Pulse signal (10% Duty Cycle, 100 μ s Width) at 2010-2200 MHz on a Class AB single-ended reference design fixture tuned for 1.8-2.2 GHz.

Thermal Information

Parameter	Conditions	Values	Units
Doherty Thermal Resistance, Peak IR Surface Temperature at Average Power (θ_{JC}) ^{(1) (2)}	$T_{CASE} = +105^\circ\text{C}$, $T_{CH} = 121^\circ\text{C}$ CW: $P_{DISS} = 11.9\text{ W}$, $P_{OUT} = 17.9\text{ W}$	1.3	$^\circ\text{C/W}$
Device Thermal Resistance, Peak IR Surface Temperature at Average Power (θ_{JC})	$T_{CASE} = +105^\circ\text{C}$, $T_{CH} = 142^\circ\text{C}$ CW: $P_{DISS} = 21.4\text{ W}$, $P_{OUT} = 5\text{ W}$	1.7	$^\circ\text{C/W}$

Notes:

- Based on expected carrier amplifier efficiency of Doherty.
- P_{OUT} assumes 20% peaking amplifier contribution of total average Doherty rated power.
- Thermal resistance is measured to package backside.
- Refer to the following document: [GaN Device Channel Temperature, Thermal Resistance, and Reliability Estimates](#)

QPD0060PCB4B01 Layout – 1800 – 2200 MHz Reference Design

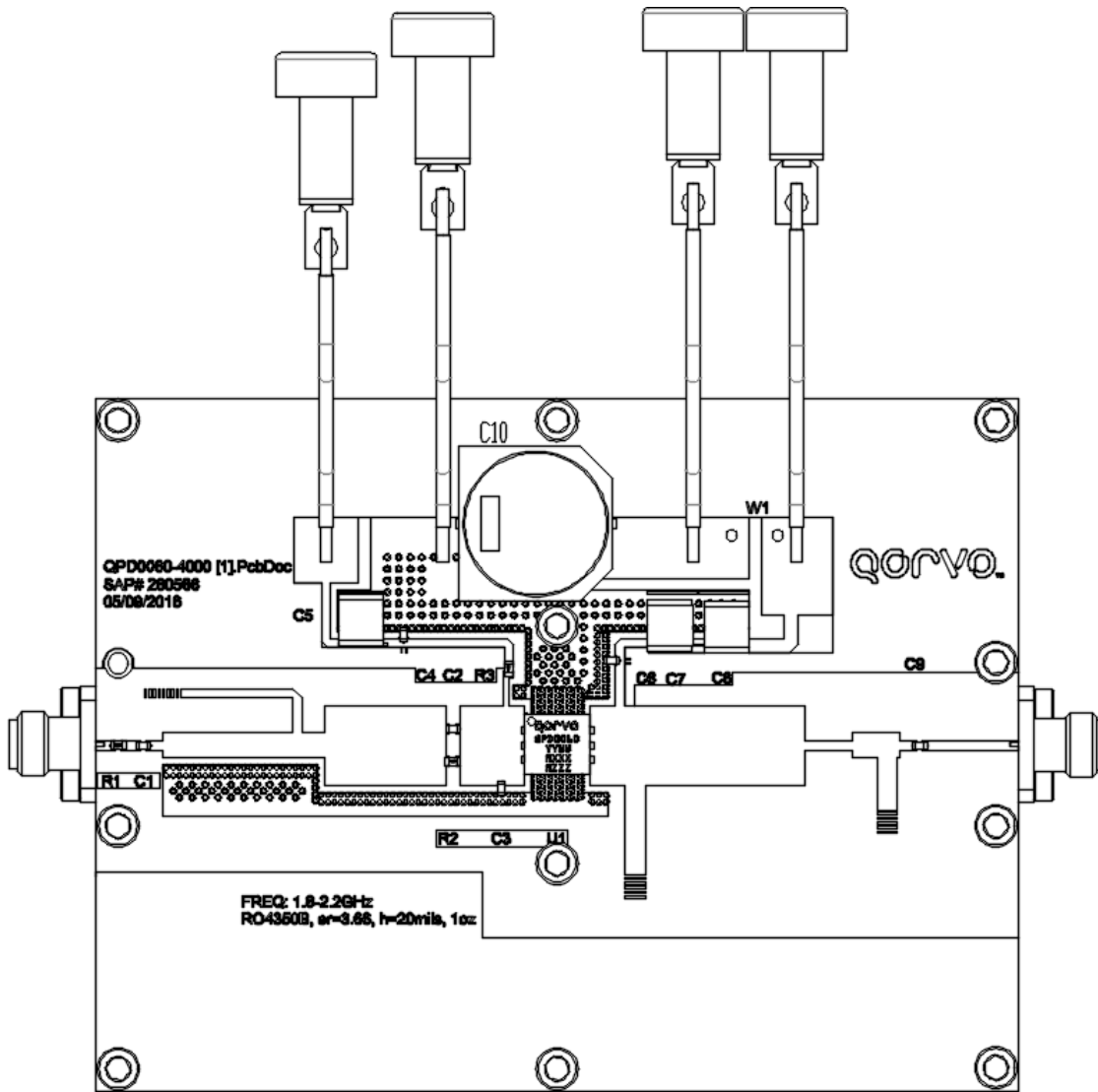

QPD0060PCB4B01 Bill of Materials

Reference Des.	Value	Description	Manufacturer	Part Number
C1	1.6 pF	Capacitor, 1.6 pF, ±0.05 pF, 250 V, HI-Q, 0603	ATC	600S1R6AT250XT
C2, C3	3 pF	Capacitor, 3 pF, ±0.1 pF, 250 V, HI-Q, 0603	ATC	600S3R0BT250XT
C4, C6, C9	20 pF	Capacitor, 20 pF, ±1%, 250 V, HI-Q, 0603	ATC	600S200FT250XT
C5, C7, C8	10 µF	Capacitor, 10 µF, ±20%, 100 V, X7S, 2220	TDK	C5750X7S2A106M230KB
C10	100 µF	Capacitor, 100 µF, ±20%, 100 V, Electrolytic	Panasonic	EEV-TG2A101M
R1	3 Ω	Resistor, 3 Ω, ±5%, 0.1 W, 0603	Vishay	CRCW06033R00FKEAC
R2	220 Ω	Resistor, 220 Ω, ±5%, 0.1 W, 0603, Lead Free	KOA Speer	RK73B1JT2D221J
R3	10 Ω	Resistor, 10 Ω, 0603, RoHS	Kamaya	RMC1/16K10R0FTP

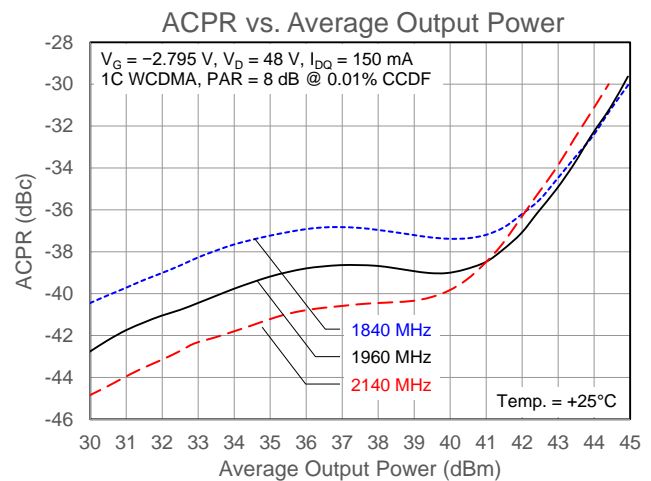
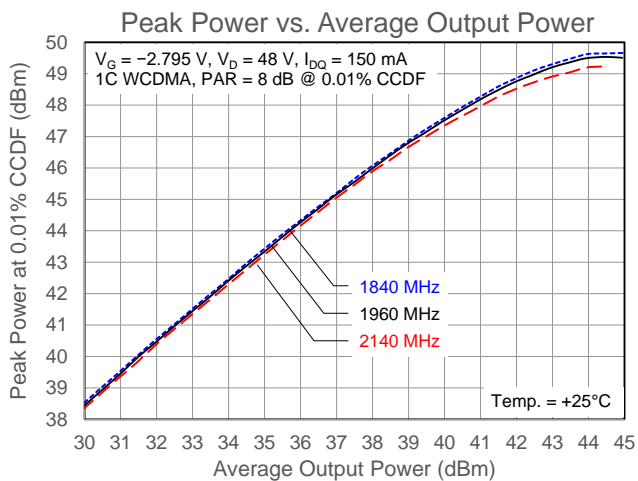
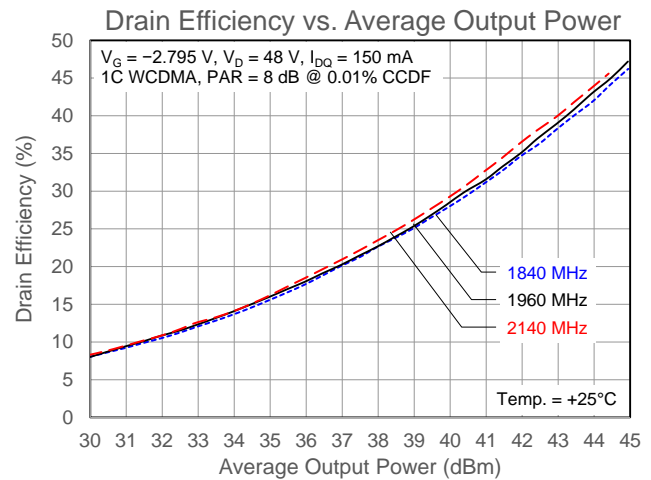
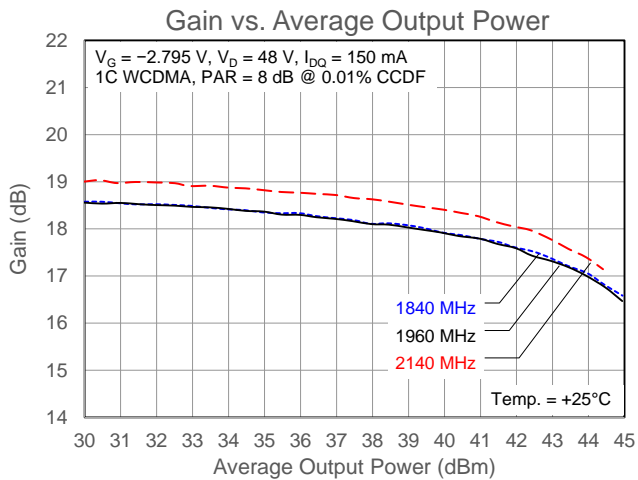
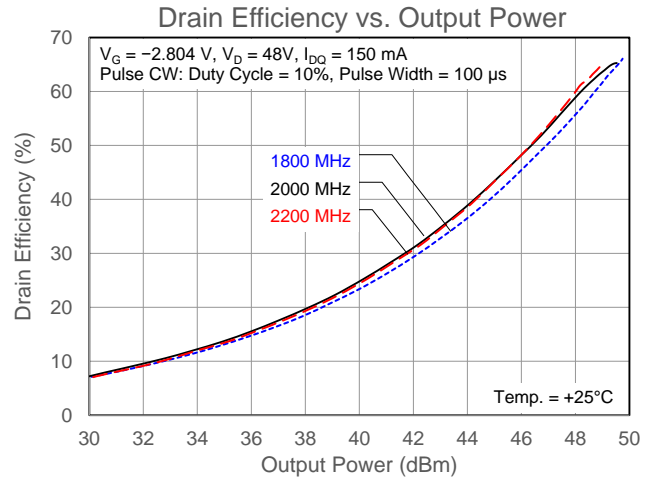
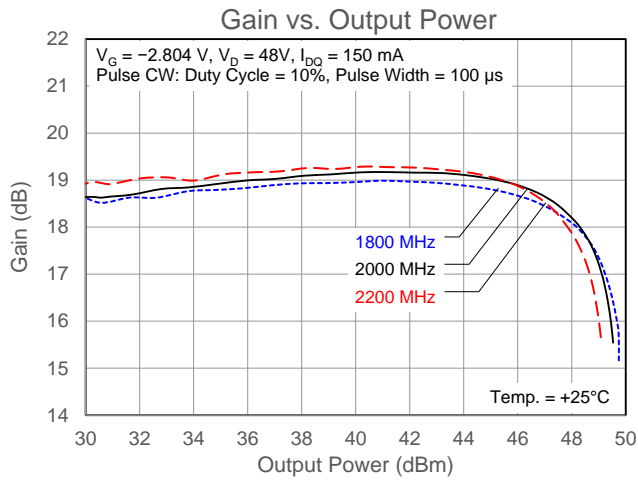
QPD0060PCB4B01 Performance Plots

Test conditions unless otherwise noted: $V_D = +48\text{ V}$, $I_{DQ} = 150\text{ mA}$, $T = +25^\circ\text{C}$, on a 1.8 – 2.2 GHz reference design fixture.

QPD0060PCB4B01 Performance Plots

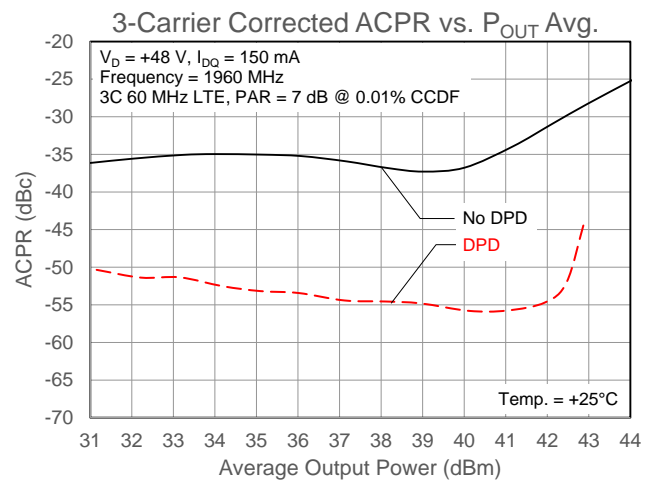
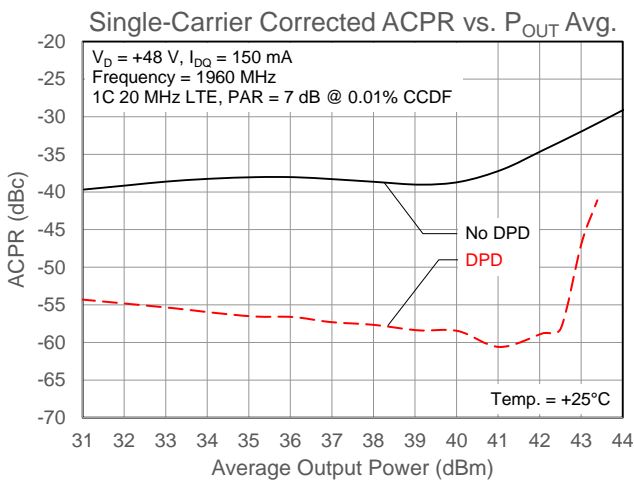
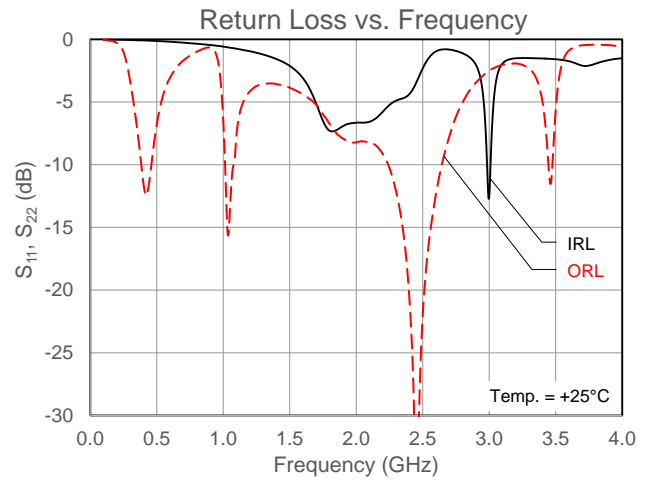
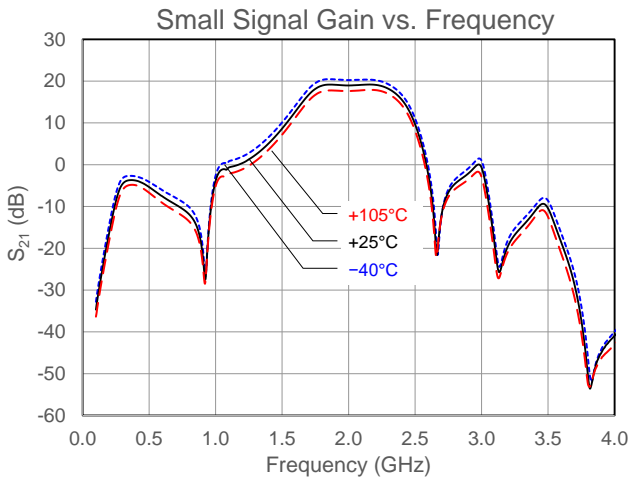

Test conditions unless otherwise noted: $V_D = +48$ V, $I_{DQ} = 150$ mA, $T = +25^\circ\text{C}$, on a 1.8 – 2.2 GHz reference design fixture.

QPD0060EVB01 Layout – 762 – 944 MHz Reference Design

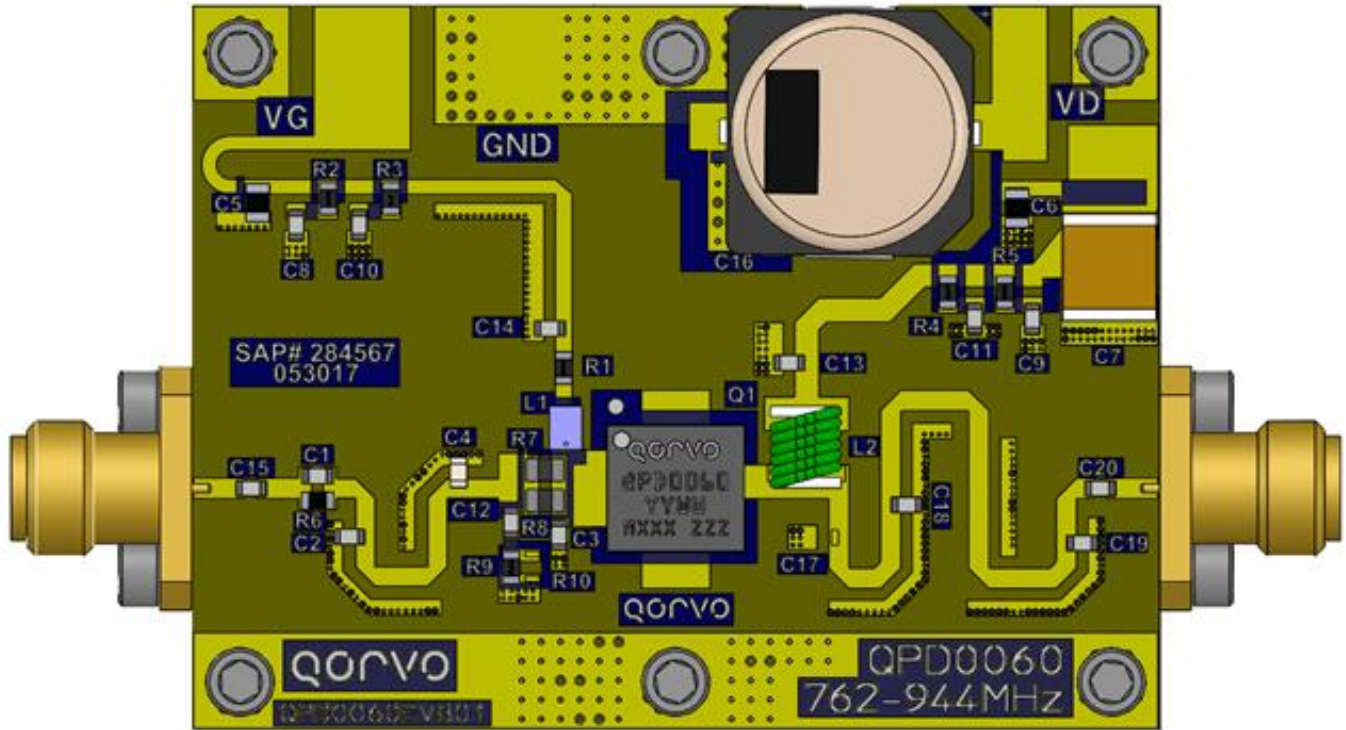

Note: PCB material is RO4350B, 20 mil thick substrate, 1 oz. copper each side.

QPD0060EVB01 Bill of Materials

Reference Des.	Value	Description	Manufacturer	Part Number
C1, C2, C15, C18	8.2 pF	Capacitor, 8.2 pF, ± 0.1 pF, 250 V, RF NPO	ATC	600S8R2BT250XT
C3, C19	3.3 pF	Capacitor, 3.3 pF, ± 0.1 pF, 250 V, RF NPO	ATC	600S3R3BT250XT
C4	22 pF	Capacitor, 22 pF, $\pm 5\%$, 250 V, RF NPO	ATC	600S220JT250XT
C5, C6	1 μ F	Capacitor, 1 μ F, $\pm 10\%$, 100 V, X7S, 0805	TDK	CGA4J3X7S2A105K
C7	10 μ F	Capacitor, 10 μ F, $\pm 10\%$, 100 V, X7S, 2220	TDK	C5750X7S2A106K230KB
C8, C9	0.1 μ F	Capacitor, 0.1 μ F, $\pm 10\%$, 100 V, X7R, 0603	Murata	GRM188R72A104KA35D
C10, C11, C12	100 pF	Capacitor, 100 pF, $\pm 5\%$, 250 V, RF C0G	TDK	C1608C0G2E101JT080AA
C13, C14	15 pF	Capacitor, 15 pF, $\pm 5\%$, 250 V, RF NPO	ATC	600S150JT250XT
C16	100 μ F	Capacitor, 100 μ F, $\pm 20\%$, 100 V, ALUM, 12.5x12.5 mm	BC Components	MAL215099907E3
C20	47 pF	Capacitor, 47 pF, $\pm 5\%$, 250 V, RF NPO	ATC	600S470JT250XT
L1	68 nH	Inductor, 68 nH, $\pm 10\%$, 0805 W/W	Coilcraft	0805CS-680XK
L2	47 nH	Inductor, 47 nH, $\pm 5\%$, 1515	Coilcraft	1515SQ-47NJ
R1, R2, R3, R4, R5	10 Ω	Resistor, 10 Ω , $\pm 5\%$, 0603, Thick Film	KOA Speer	RK73B1JT250J
R6	1 k Ω	Resistor, 1000 Ω , $\pm 1\%$, 0603, Thick Film	Cal-Chip	RM06F1001CT
R7, R8	5.1 Ω	Resistor, 5.1 Ω , $\pm 1\%$, 0805, Thick Film	Vishay	CRCW08055R10FKEA
R9	120 Ω	0603 1% Thick Film Resistor	KOA Speer	RK73B1JT250J

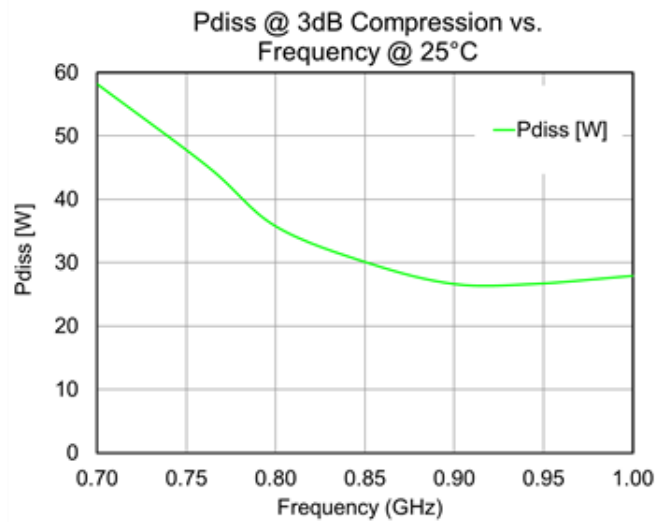
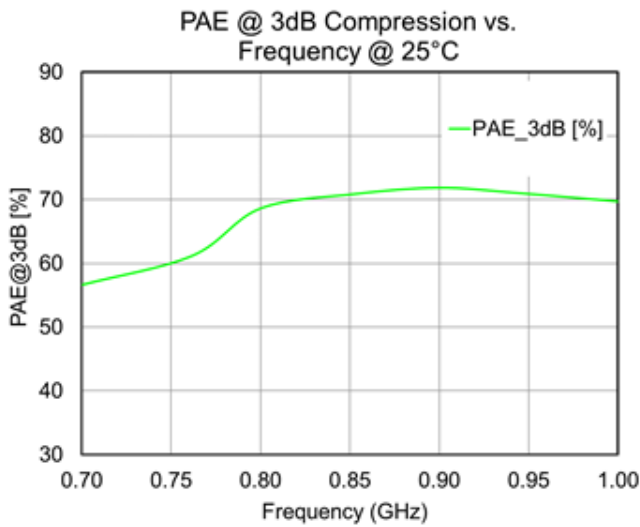
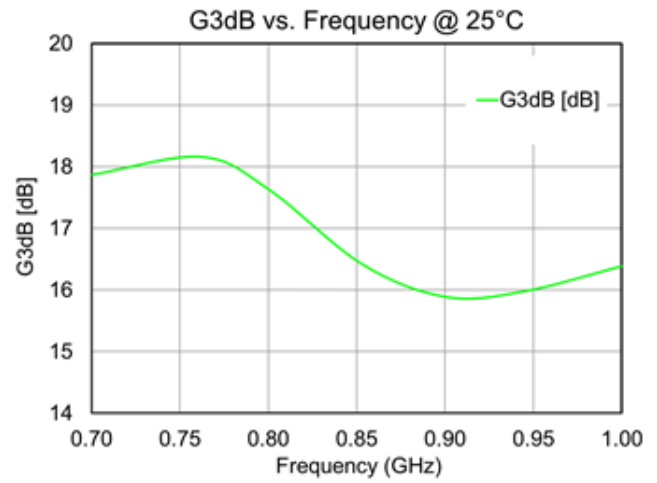
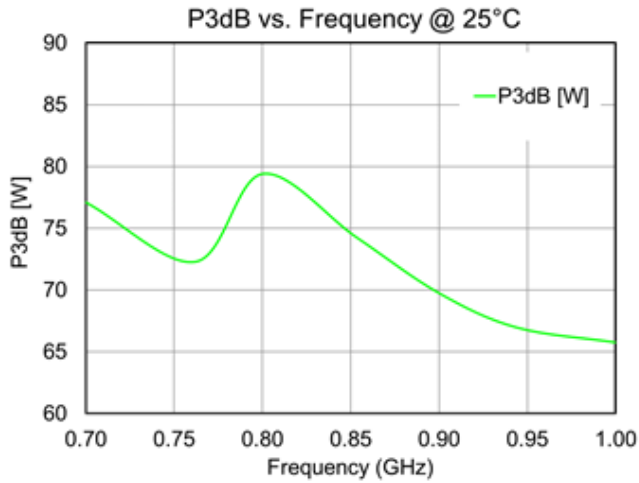
QPD0060EVB01 Performance Plots

Test conditions unless otherwise noted: $V_D = +50\text{ V}$, $I_{DQ} = 150\text{ mA}$, $T = +25^\circ\text{C}$, Pulsed (10% Duty Cycle, 100 μs Width) on a 762 – 944 MHz reference design fixture.

Power-Matched Load Pull Performance

Frequency (MHz)	Source Impedance (Ω)	Load Impedance (Ω)	P3dB (dBm)	Drain Efficiency (%)	G3dB (dB)
1800	2.0 – j6.0	5.7 + j1.4	49.2	61.2	19.9
1900	2.1 – j6.9	5.5 + j0.7	49.2	62.0	19.7
2100	2.9 – j10.3	6.4 + j1.0	49.5	65.7	19.6
2200	4.2 – j13.5	5.0 + j.01	49.5	65.9	18.7
2600	8.9 + j13.3	4.8 + j0.0	49.0	63.0	18.2
3500	2.1 – j9.1	3.4 – j5.8	49.7	57.7	13.4

Test conditions unless otherwise noted: $V_D = +48\text{ V}$, $I_{DQ} = 150\text{ mA}$, $T = +25^\circ\text{C}$, Pulse (10% Duty Cycle, 100 μs Width).

Efficiency-Matched Load Pull Performance

Frequency (MHz)	Source Impedance (Ω)	Load Impedance (Ω)	P3dB (dBm)	Drain Efficiency (%)	G3dB (dB)
1800	2.0 – j6.0	5.4 + j7.3	47.2	74.9	21.9
1900	2.1 – j6.9	5.1 + j5.7	47.7	75.8	22.0
2100	2.9 – j10.3	4.7 + j3.5	48.5	74.7	21.5
2200	4.2 – j13.5	4.7 + j3.5	48.4	73.9	20.9
2600	8.9 + j13.3	3.1 + 2.6	46.6	68.3	20.0
3500	2.1 – j9.1	2.0 – j3.6	48.0	68.2	15.0

Test conditions unless otherwise noted: $V_D = +48\text{ V}$, $I_{DQ} = 150\text{ mA}$, $T = +25^\circ\text{C}$, Pulse (10% Duty Cycle, 100 μs Width).

Load Pull Contours

Test Conditions unless otherwise noted: $V_D = +48\text{ V}$, $I_{DQ} = 150\text{ mA}$, $T = +25^\circ\text{C}$, Pulse (10% Duty Cycle, 100 μs Width).

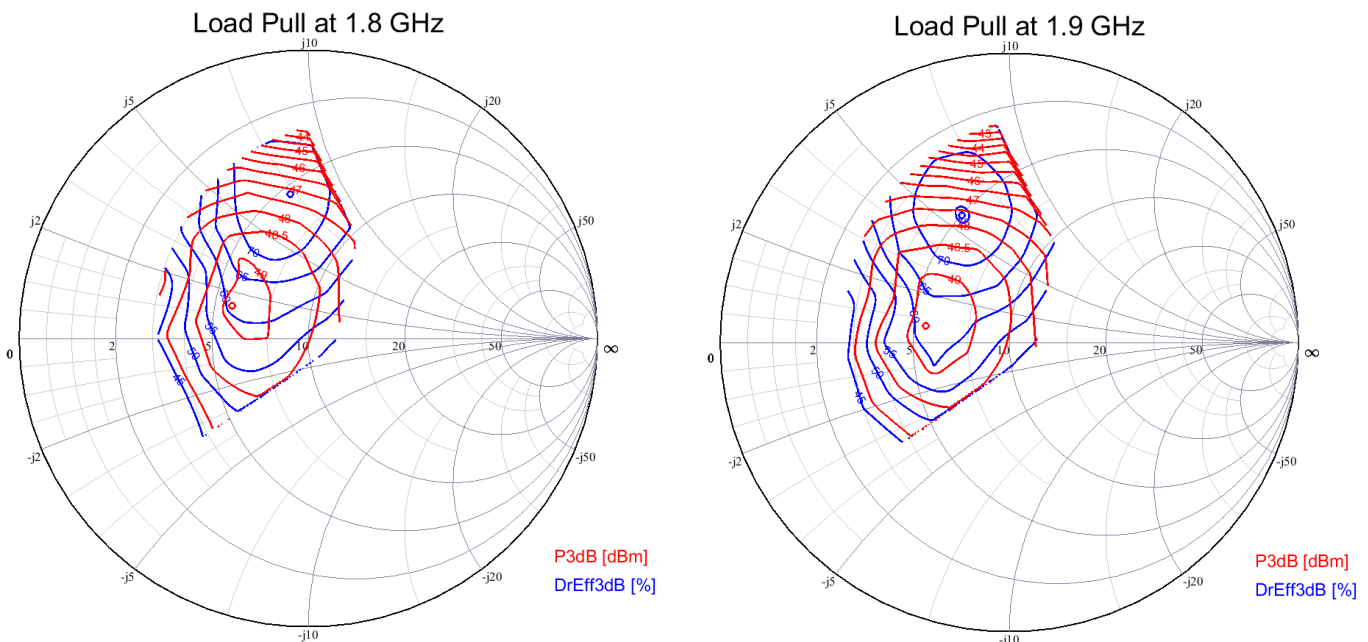

Load Pull Contours

Test Conditions unless otherwise noted: $V_D = +48\text{ V}$, $I_{DQ} = 150\text{ mA}$, $T = +25^\circ\text{C}$, Pulse (10% Duty Cycle, 100 μs Width).

Load Pull at 2.1 GHz

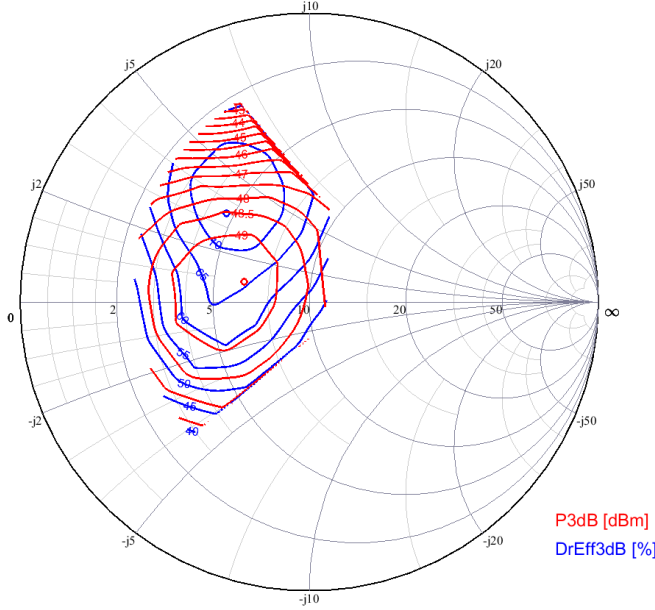

Load Pull at 2.2 GHz

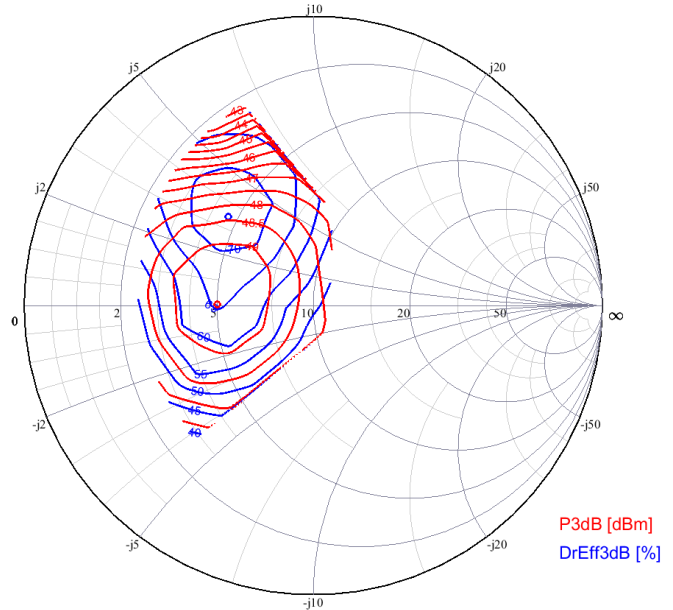

Load Pull at 2.6 GHz

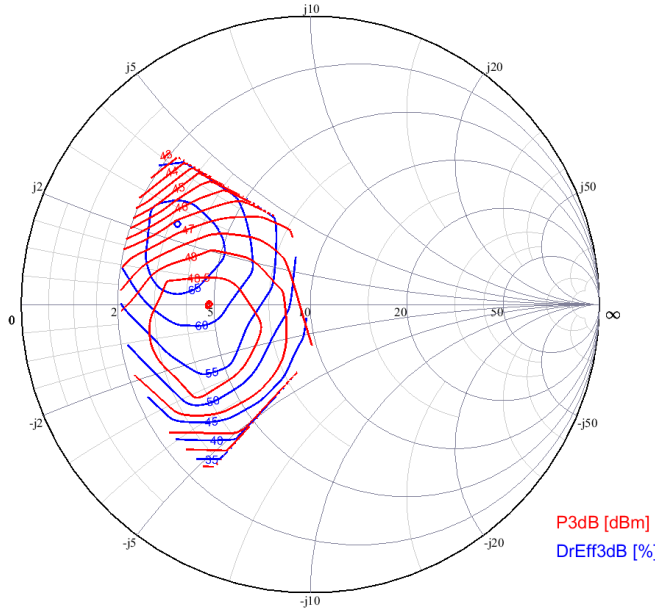

Load Pull at 3.5 GHz

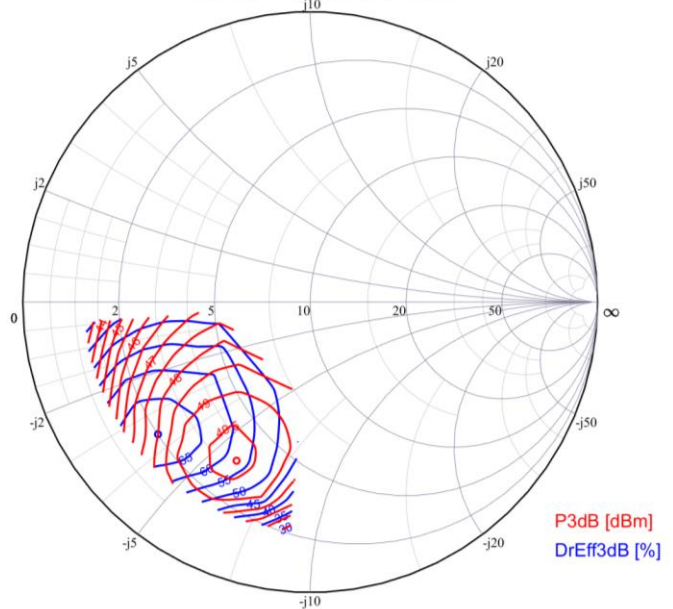

Package Markings

Marking: Qorvo Logo
 Part Number – QPD0060
 Date Code – YYWW
 Lot Code – MXXX
 Serial Number – ZZZ

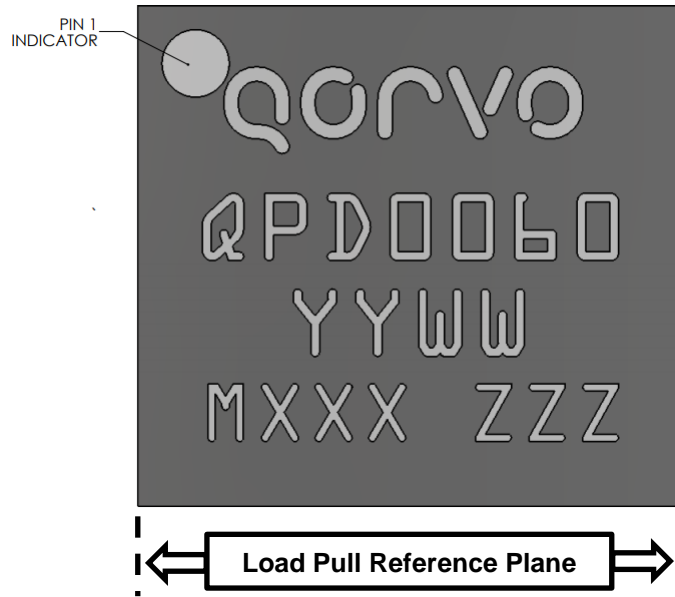

Package Dimensions

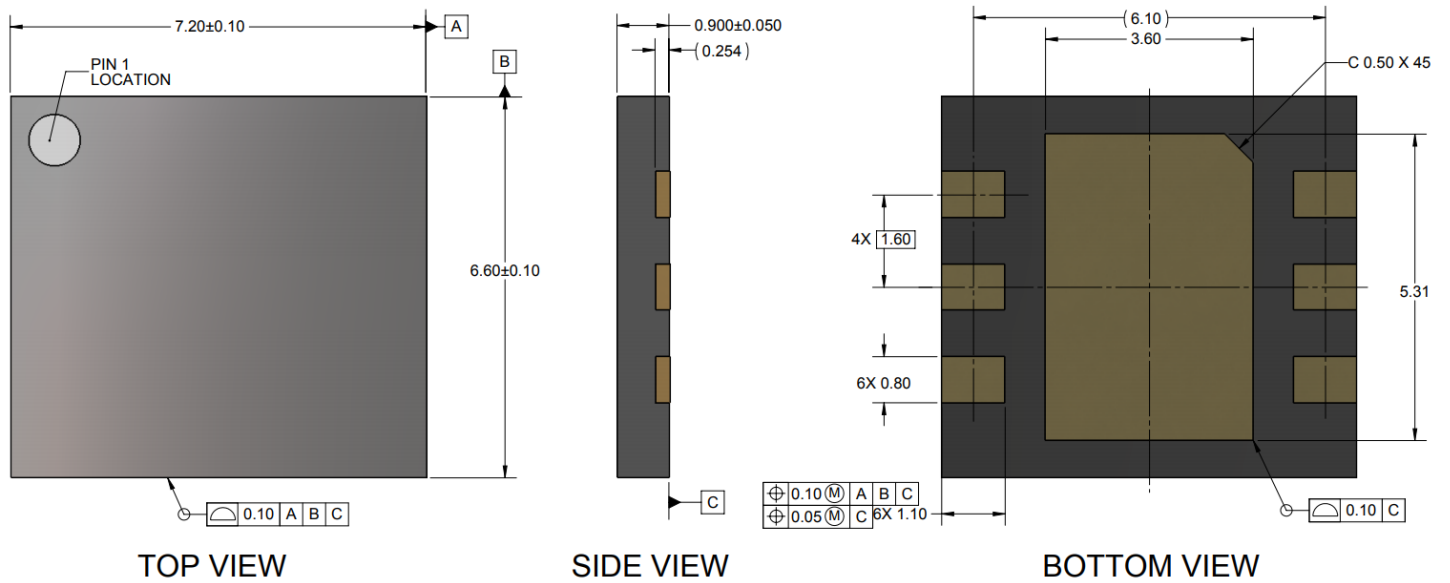

Notes:

1. Dimensions are in millimeters [inches]. Angles are in degrees.
2. Part is overmold encapsulated.
3. Contact plating is NiPdAu. Au thickness is 0.00254 to 0.01501 μm.
4. General tolerance is ±0.25.

Pin Configuration and Description

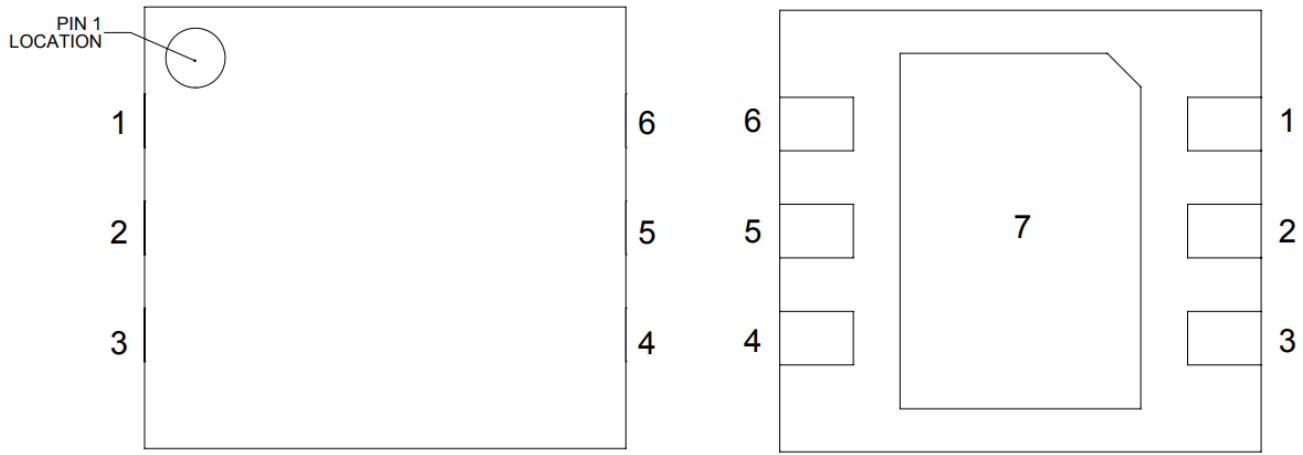

TOP VIEW

BOTTOM VIEW

Pin Number	Label	Description
1, 2, 3	RF IN, V_G	RF Input, Gate Bias
4, 5, 6	RF OUT, V_D	RF Output, Drain Bias
7 (Backside Paddle)	RF/DC GND	RF/DC Ground

Bias Procedure

Bias On	Bias Off
<ol style="list-style-type: none"> 1. Turn ON V_G to -4 V. 2. Turn ON V_D to $+48$ V. 3. Slowly adjust V_G until I_D is set to 130 mA. (Typically, $V_G = -2.7$ V.) 5. Turn ON RF. 	<ol style="list-style-type: none"> 1. Turn OFF RF. 2. Set V_G to -5 V. 3. Turn OFF V_D. 4. Wait two (2) seconds to allow drain capacitor to discharge. 5. Turn OFF V_G.

Recommended Solder Temperature Profile

