

## Product Overview

The QPD0060 is a wide band plastic overmolded DFN discrete power amplifier. The device is a single stage unmatched power amplifier transistor.

The QPD0060 can be used in Doherty architecture for the final stage of a base station amplifier for small cell, microcell, and active antenna systems. The QPD0060 can also be used as a driver in a macrocell base station power amplifier.

The wide bandwidth of the QPD0060 makes it suitable for many different applications from DC to 2.7 GHz. QPD0060 can deliver  $P_{SAT}$  of 89.1 W at +48 V operation at 2.1 GHz.

Lead-free and RoHS compliant.



6 Pin 7.2 x 6.6 mm DFN Package

## Key Features

- Operating Frequency Range: DC to 2.7 GHz
- Operating Drain Voltage: +48 V
- Maximum Output Power ( $P_{SAT}$ ): 89.1 W <sup>(1)</sup>
- Maximum Drain Efficiency: 74.7% <sup>(1)</sup>
- Efficiency-Tuned P3dB Gain: 21.5 dB <sup>(1)</sup>
- Surface Mount Plastic Package

Notes:

1. Load pull performance at 2.1 GHz.

## Functional Block Diagram

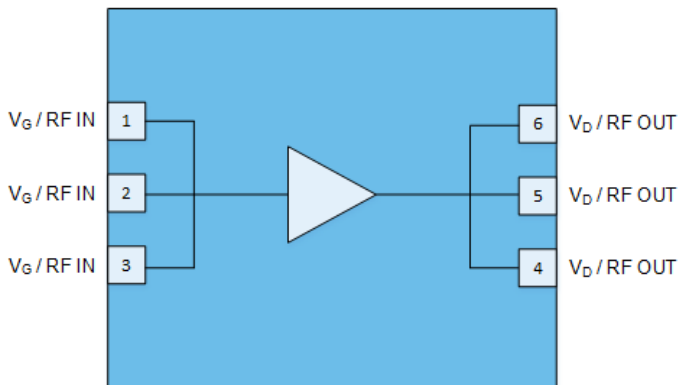

## Applications

- W-CDMA / LTE
- Macrocell Base Station Driver
- Microcell Base Station
- Small Cell Final Stage
- Active Antenna
- General Purpose Applications

## Ordering Information

Part Number	Description
QPD0060SR	Short Reel – 100 Pieces
QPD0060TR7	7" Reel – 500 pieces
QPD0060PCB4B01	1.8 – 2.2 GHz Evaluation Board
QPD0060EVB01	762 – 944 MHz Evaluation Board

## Absolute Maximum Ratings

Parameter	Rating
Breakdown Voltage ( $V_{BDG}$ )	+165 V
Gate Voltage Range ( $V_G$ )	-7 to +2 V
Drain Voltage ( $V_D$ )	+55 V
Peak RF Input Power	38 dBm
VSWR Mismatch, P1dB Pulse (20% Duty Cycle, 100 $\mu$ s Width), $T = +25^\circ\text{C}$	10:1

Exceeding any one or a combination of the Absolute Maximum Rating conditions may cause permanent damage to the device. Extended application of Absolute Maximum Rating conditions to the device may reduce device reliability.

## Recommended Operating Conditions

Parameter	Min	Typ	Max	Units
Gate Voltage ( $V_G$ )		-2.7		V
Drain Voltage ( $V_D$ )		+48		V
Quiescent Drain Current ( $I_{DQ}$ )		130		mA

Electrical specifications are measured at specified test conditions. Specifications are not guaranteed over all recommended operating conditions.

## Electrical Specifications

Parameter	Conditions	Min	Typ	Max	Units
Operational Frequency Range		1800		2200	MHz
Quiescent Drain Current ( $I_{DQ}$ )			130		mA
Gain	3 dB Compression	14.7	16.4		dB
Power ( $P_{SAT}$ )	3 dB Compression	48.1	49.8		dBm
Drain Efficiency	3 dB Compression	60.0	69.2		%

Test conditions unless otherwise noted:  $V_D = +48\text{ V}$ ,  $I_{DQ} = 130\text{ mA}$ ,  $T = +25^\circ\text{C}$ , Pulse signal (10% Duty Cycle, 100  $\mu$ s Width) at 2010-2200 MHz on a Class AB single-ended reference design fixture tuned for 1.8-2.2 GHz.

## Thermal Information

Parameter	Conditions	Values	Units
Doherty Thermal Resistance, Peak IR Surface Temperature at Average Power ( $\theta_{JC}$ ) <sup>(1) (2)</sup>	$T_{CASE} = +105^\circ\text{C}$ , $T_{CH} = 121^\circ\text{C}$ CW: $P_{DISS} = 11.9\text{ W}$ , $P_{OUT} = 17.9\text{ W}$	1.3	$^\circ\text{C/W}$
Device Thermal Resistance, Peak IR Surface Temperature at Average Power ( $\theta_{JC}$ )	$T_{CASE} = +105^\circ\text{C}$ , $T_{CH} = 142^\circ\text{C}$ CW: $P_{DISS} = 21.4\text{ W}$ , $P_{OUT} = 5\text{ W}$	1.7	$^\circ\text{C/W}$

Notes:

1. Based on expected carrier amplifier efficiency of Doherty.
2.  $P_{OUT}$  assumes 20% peaking amplifier contribution of total average Doherty rated power.
3. Thermal resistance is measured to package backside.
4. Refer to the following document: [GaN Device Channel Temperature, Thermal Resistance, and Reliability Estimates](#)

QPD0060PCB4B01 Layout – 1800 – 2200 MHz Reference Design

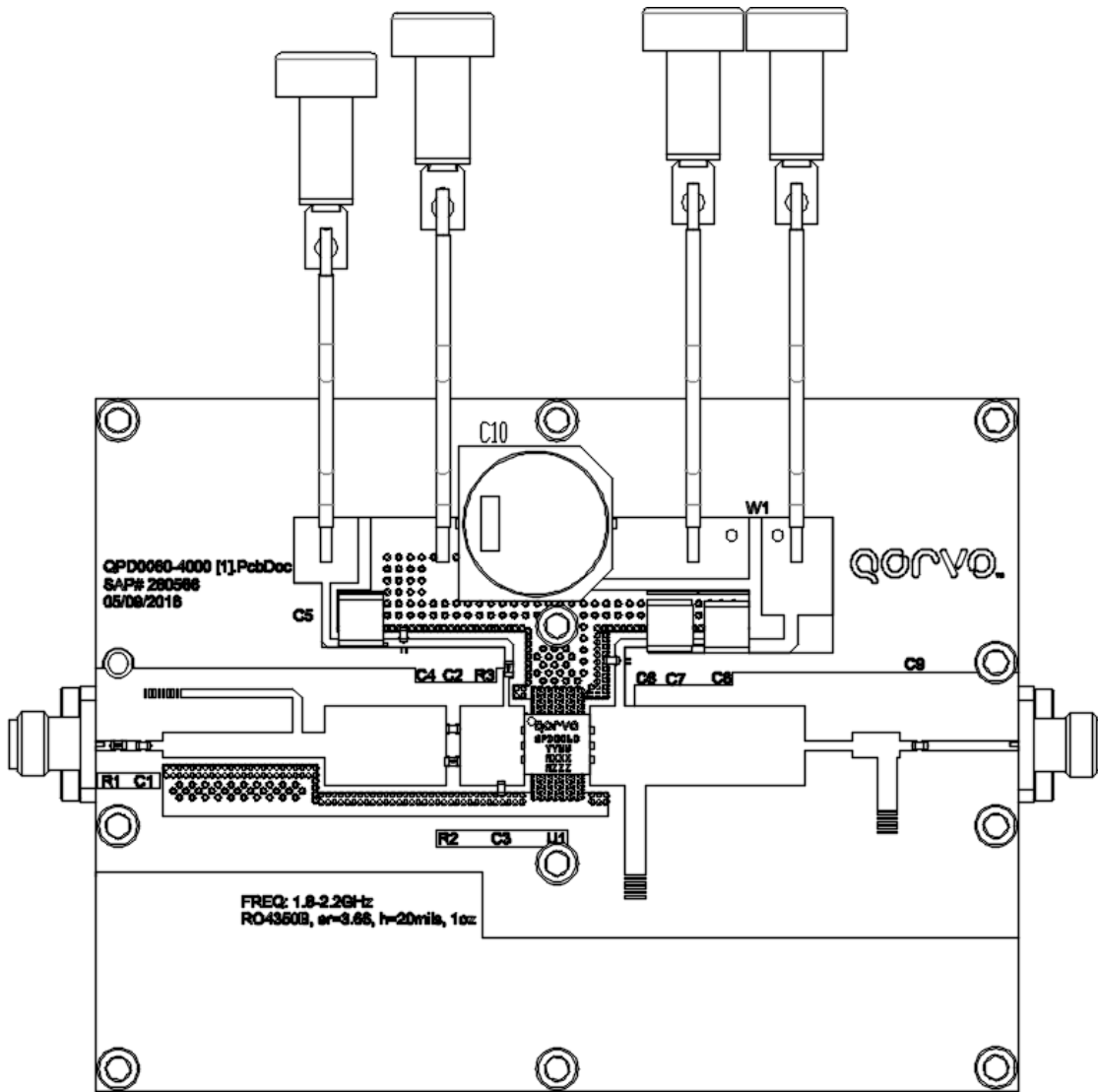

QPD0060PCB4B01 Bill of Materials

Reference Des.	Value	Description	Manufacturer	Part Number
C1	1.6 pF	Capacitor, 1.6 pF, ±0.05 pF, 250 V, HI-Q, 0603	ATC	600S1R6AT250XT
C2, C3	3 pF	Capacitor, 3 pF, ±0.1 pF, 250 V, HI-Q, 0603	ATC	600S3R0BT250XT
C4, C6, C9	20 pF	Capacitor, 20 pF, ±1%, 250 V, HI-Q, 0603	ATC	600S200FT250XT
C5, C7, C8	10 µF	Capacitor, 10 µF, ±20%, 100 V, X7S, 2220	TDK	C5750X7S2A106M230KB
C10	100 µF	Capacitor, 100 µF, ±20%, 100 V, Electrolytic	Panasonic	EEV-TG2A101M
R1	3 Ω	Resistor, 3 Ω, ±5%, 0.1 W, 0603	Vishay	CRCW06033R00FKEAC
R2	220 Ω	Resistor, 220 Ω, ±5%, 0.1 W, 0603, Lead Free	KOA Speer	RK73B1JT2D221J
R3	10 Ω	Resistor, 10 Ω, 0603, RoHS	Kamaya	RMC1/16K10R0FTP

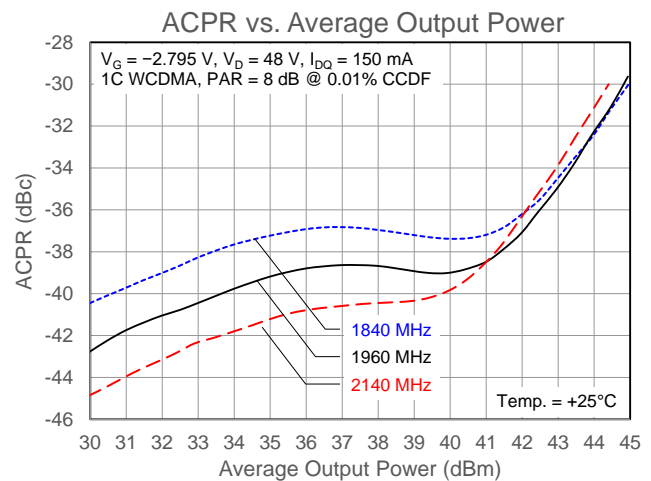
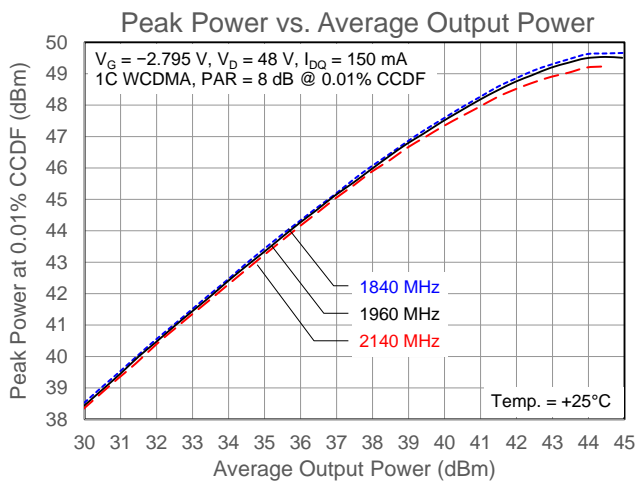
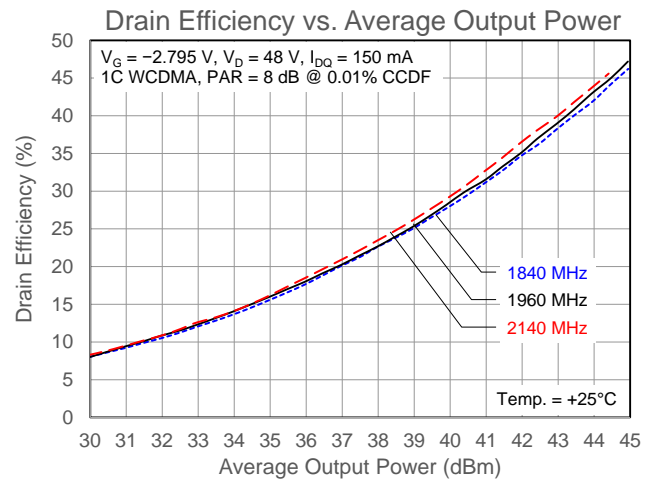
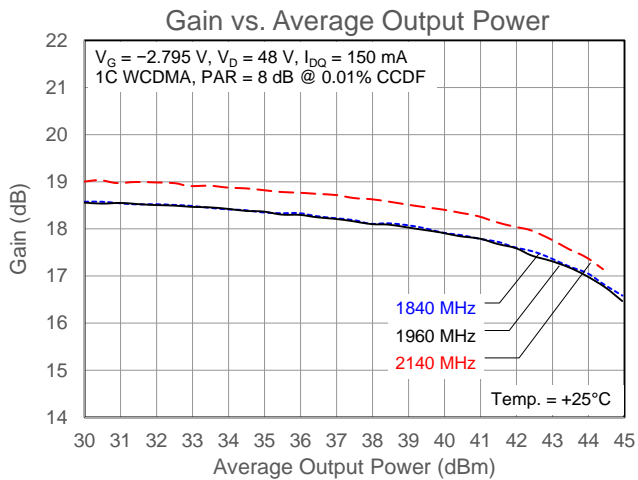
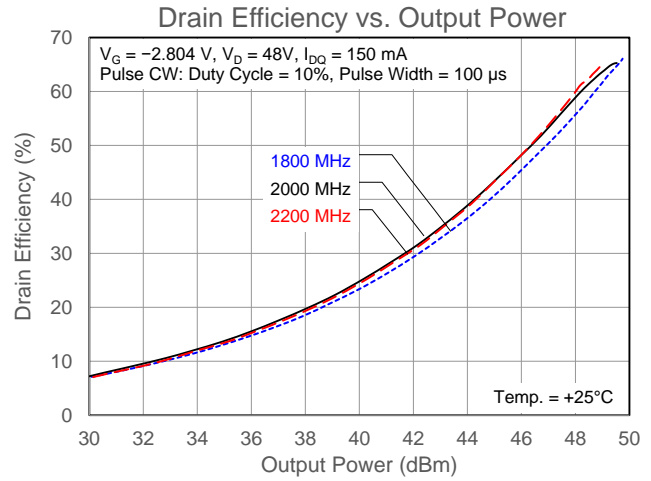
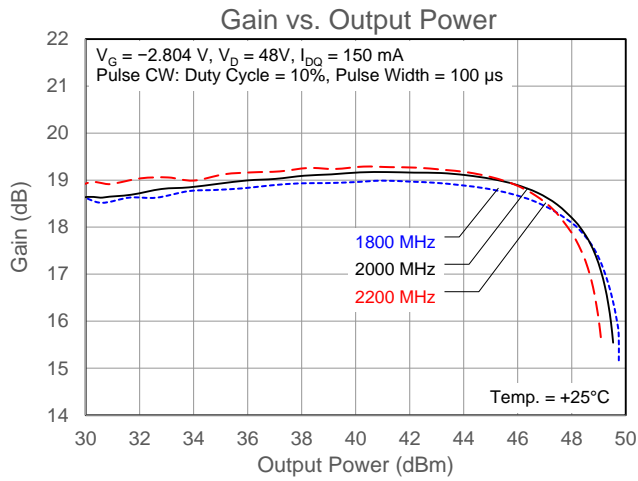
**QPD0060PCB4B01 Performance Plots**

Test conditions unless otherwise noted:  $V_D = +48\text{ V}$ ,  $I_{DQ} = 150\text{ mA}$ ,  $T = +25^\circ\text{C}$ , on a 1.8 – 2.2 GHz reference design fixture.

QPD0060PCB4B01 Performance Plots

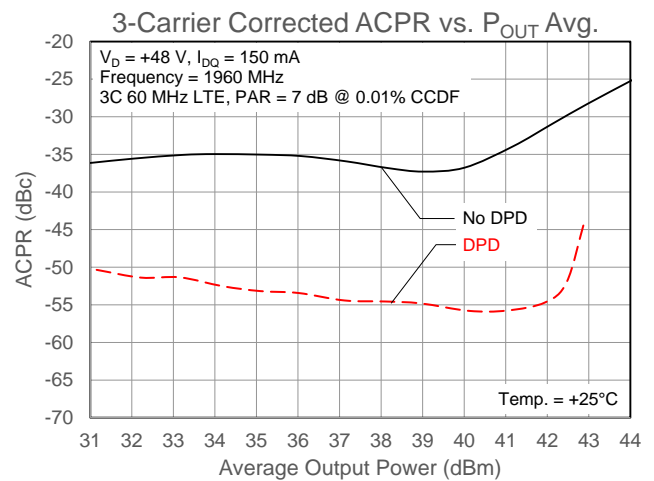
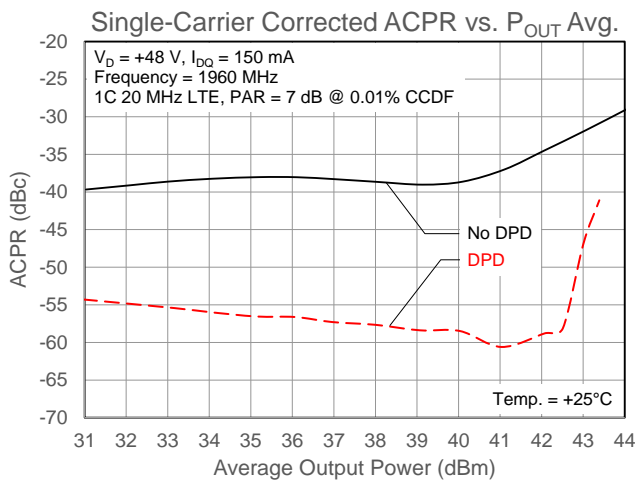
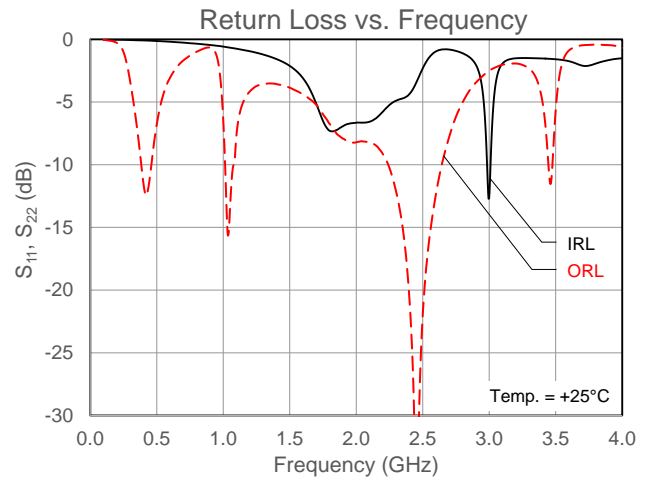
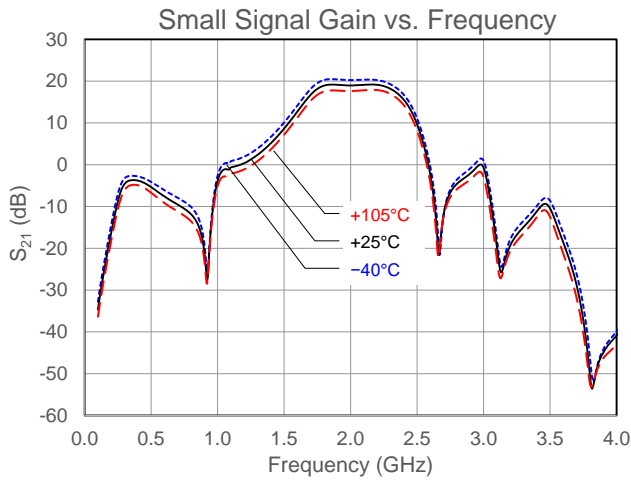

Test conditions unless otherwise noted:  $V_D = +48$  V,  $I_{DQ} = 150$  mA,  $T = +25^\circ\text{C}$ , on a 1.8 – 2.2 GHz reference design fixture.

## QPD0060EVB01 Layout – 762 – 944 MHz Reference Design

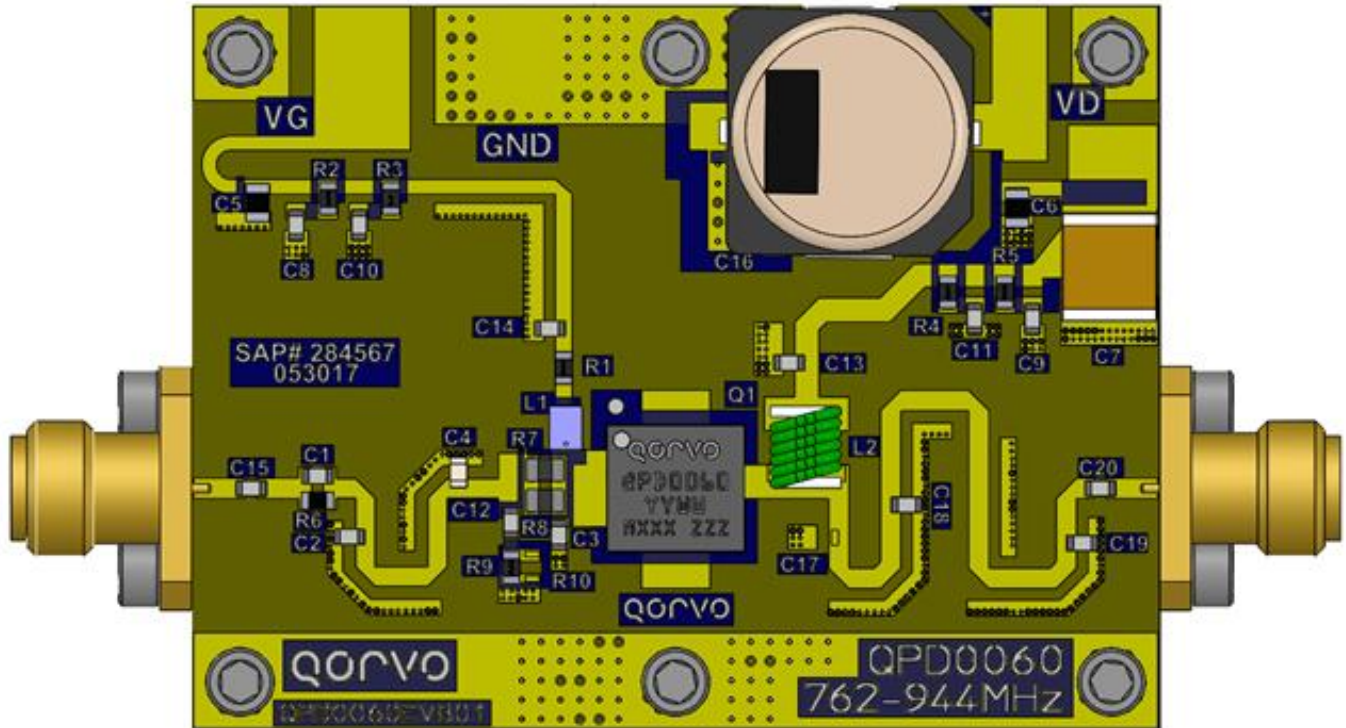

Note: PCB material is RO4350B, 20 mil thick substrate, 1 oz. copper each side.

## QPD0060EVB01 Bill of Materials

Reference Des.	Value	Description	Manufacturer	Part Number
C1, C2, C15, C18	8.2 pF	Capacitor, 8.2 pF, $\pm 0.1$ pF, 250 V, RF NPO	ATC	600S8R2BT250XT
C3, C19	3.3 pF	Capacitor, 3.3 pF, $\pm 0.1$ pF, 250 V, RF NPO	ATC	600S3R3BT250XT
C4	22 pF	Capacitor, 22 pF, $\pm 5\%$ , 250 V, RF NPO	ATC	600S220JT250XT
C5, C6	1 $\mu$ F	Capacitor, 1 $\mu$ F, $\pm 10\%$ , 100 V, X7S, 0805	TDK	CGA4J3X7S2A105K
C7	10 $\mu$ F	Capacitor, 10 $\mu$ F, $\pm 10\%$ , 100 V, X7S, 2220	TDK	C5750X7S2A106K230KB
C8, C9	0.1 $\mu$ F	Capacitor, 0.1 $\mu$ F, $\pm 10\%$ , 100 V, X7R, 0603	Murata	GRM188R72A104KA35D
C10, C11, C12	100 pF	Capacitor, 100 pF, $\pm 5\%$ , 250 V, RF C0G	TDK	C1608C0G2E101JT080AA
C13, C14	15 pF	Capacitor, 15 pF, $\pm 5\%$ , 250 V, RF NPO	ATC	600S150JT250XT
C16	100 $\mu$ F	Capacitor, 100 $\mu$ F, $\pm 20\%$ , 100 V, ALUM, 12.5x12.5 mm	BC Components	MAL215099907E3
C20	47 pF	Capacitor, 47 pF, $\pm 5\%$ , 250 V, RF NPO	ATC	600S470JT250XT
L1	68 nH	Inductor, 68 nH, $\pm 10\%$ , 0805 W/W	Coilcraft	0805CS-680XK
L2	47 nH	Inductor, 47 nH, $\pm 5\%$ , 1515	Coilcraft	1515SQ-47NJ
R1, R2, R3, R4, R5	10 $\Omega$	Resistor, 10 $\Omega$ , $\pm 5\%$ , 0603, Thick Film	KOA Speer	RK73B1JT250J
R6	1 k $\Omega$	Resistor, 1000 $\Omega$ , $\pm 1\%$ , 0603, Thick Film	Cal-Chip	RM06F1001CT
R7, R8	5.1 $\Omega$	Resistor, 5.1 $\Omega$ , $\pm 1\%$ , 0805, Thick Film	Vishay	CRCW08055R10FKEA
R9	120 $\Omega$	0603 1% Thick Film Resistor	KOA Speer	RK73B1JT250J

QPD0060EVB01 Performance Plots

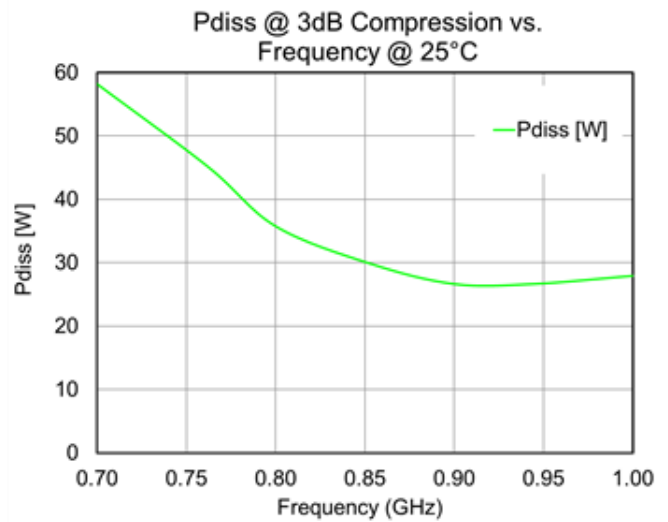
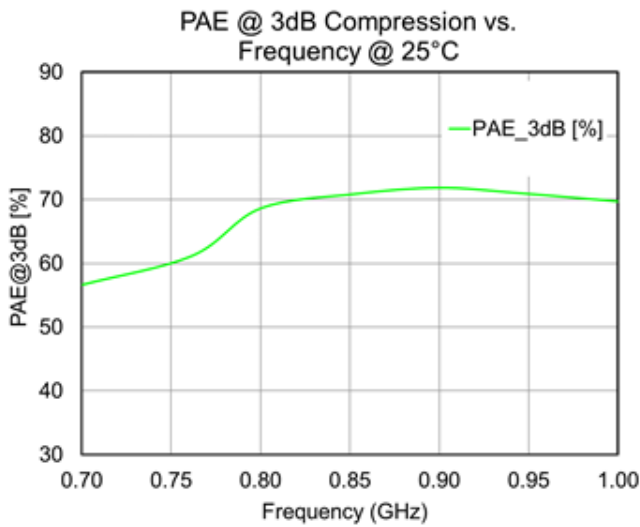
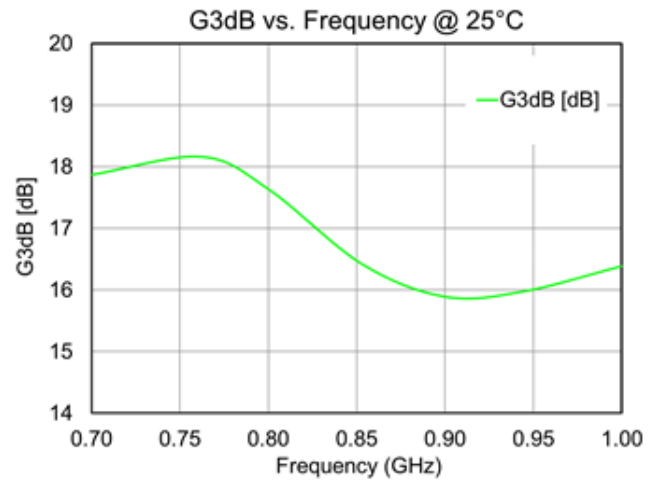
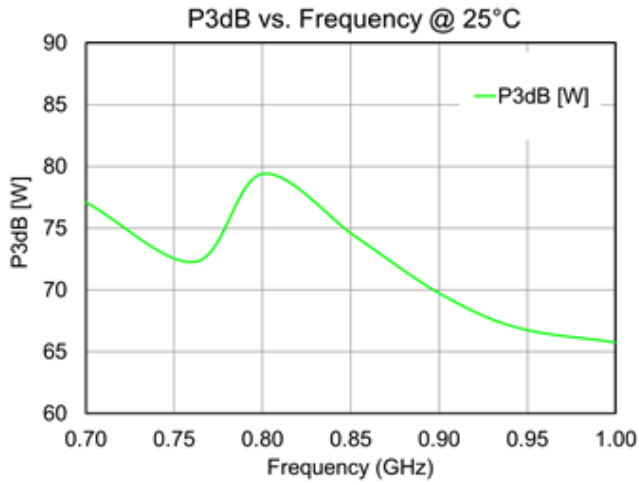

Test conditions unless otherwise noted:  $V_D = +50$  V,  $I_{DQ} = 150$  mA,  $T = +25^\circ\text{C}$ , Pulsed (10% Duty Cycle, 100  $\mu\text{s}$  Width) on a 762 – 944 MHz reference design fixture.

## Power-Matched Load Pull Performance

Frequency (MHz)	Source Impedance ( $\Omega$ )	Load Impedance ( $\Omega$ )	P3dB (dBm)	Drain Efficiency (%)	G3dB (dB)
1800	2.0 – j6.0	5.7 + j1.4	49.2	61.2	19.9
1900	2.1 – j6.9	5.5 + j0.7	49.2	62.0	19.7
2100	2.9 – j10.3	6.4 + j1.0	49.5	65.7	19.6
2200	4.2 – j13.5	5.0 + j.01	49.5	65.9	18.7
2600	8.9 + j13.3	4.8 + j0.0	49.0	63.0	18.2
3500	2.1 – j9.1	3.4 – j5.8	49.7	57.7	13.4

Test conditions unless otherwise noted:  $V_D = +48\text{ V}$ ,  $I_{DQ} = 150\text{ mA}$ ,  $T = +25^\circ\text{C}$ , Pulse (10% Duty Cycle, 100  $\mu\text{s}$  Width).

## Efficiency-Matched Load Pull Performance

Frequency (MHz)	Source Impedance ( $\Omega$ )	Load Impedance ( $\Omega$ )	P3dB (dBm)	Drain Efficiency (%)	G3dB (dB)
1800	2.0 – j6.0	5.4 + j7.3	47.2	74.9	21.9
1900	2.1 – j6.9	5.1 + j5.7	47.7	75.8	22.0
2100	2.9 – j10.3	4.7 + j3.5	48.5	74.7	21.5
2200	4.2 – j13.5	4.7 + j3.5	48.4	73.9	20.9
2600	8.9 + j13.3	3.1 + 2.6	46.6	68.3	20.0
3500	2.1 – j9.1	2.0 – j3.6	48.0	68.2	15.0

Test conditions unless otherwise noted:  $V_D = +48\text{ V}$ ,  $I_{DQ} = 150\text{ mA}$ ,  $T = +25^\circ\text{C}$ , Pulse (10% Duty Cycle, 100  $\mu\text{s}$  Width).

## Load Pull Contours

Test Conditions unless otherwise noted:  $V_D = +48\text{ V}$ ,  $I_{DQ} = 150\text{ mA}$ ,  $T = +25^\circ\text{C}$ , Pulse (10% Duty Cycle, 100  $\mu\text{s}$  Width).

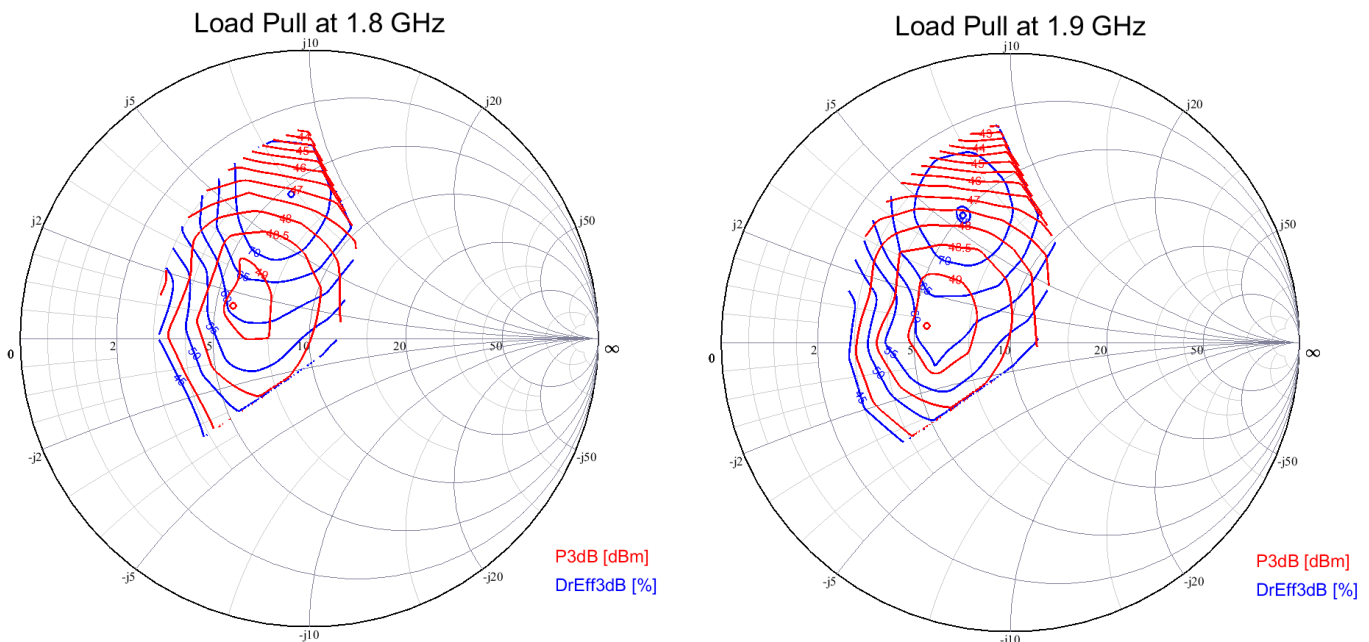



**Load Pull Contours**

Test Conditions unless otherwise noted:  $V_D = +48\text{ V}$ ,  $I_{DQ} = 150\text{ mA}$ ,  $T = +25^\circ\text{C}$ , Pulse (10% Duty Cycle, 100  $\mu\text{s}$  Width).

Load Pull at 2.1 GHz

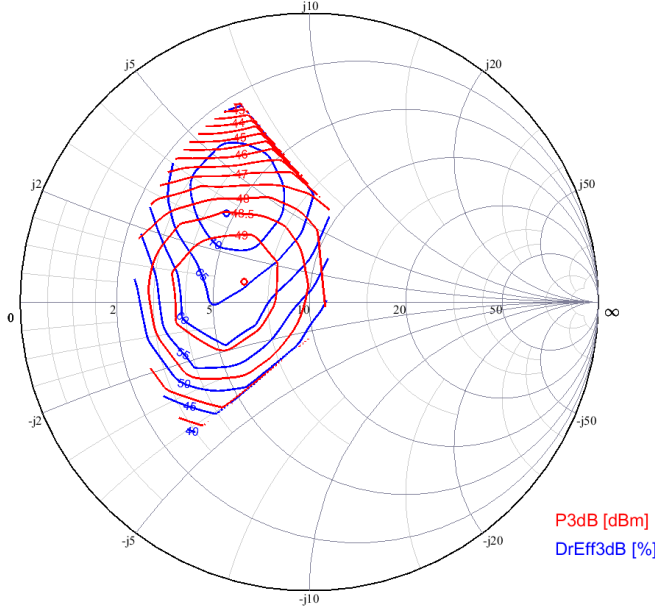

Load Pull at 2.2 GHz

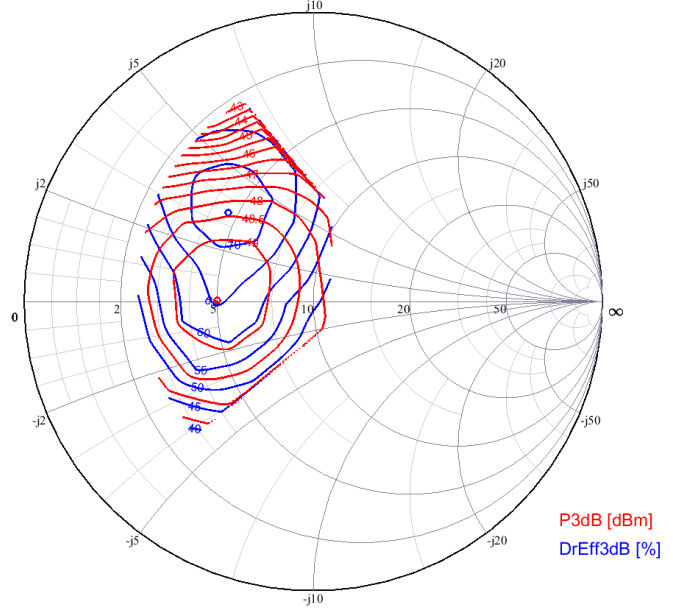

Load Pull at 2.6 GHz

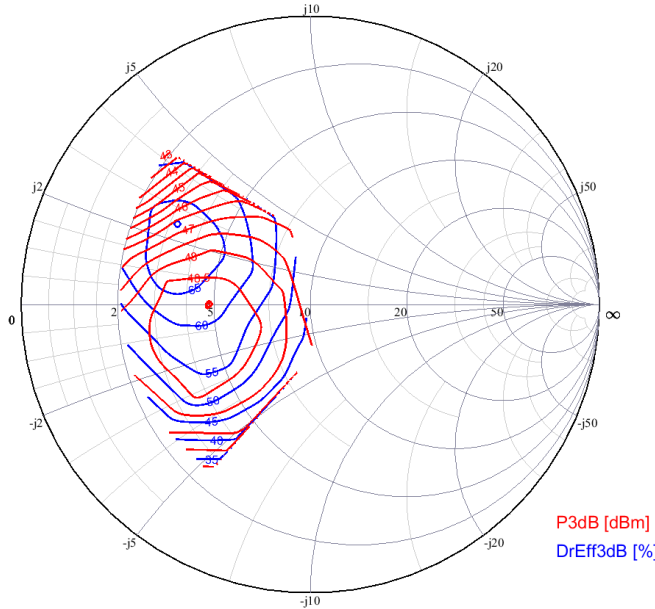

Load Pull at 3.5 GHz

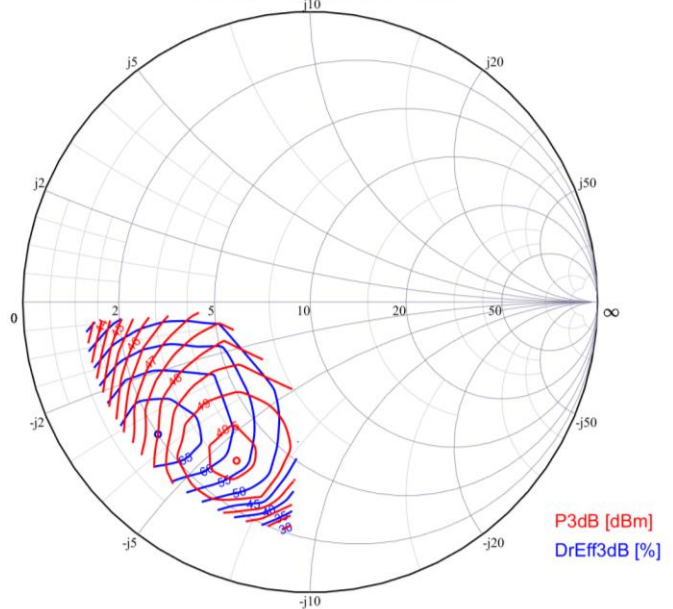

**Package Markings**

Marking: Qorvo Logo  
 Part Number – QPD0060  
 Date Code – YYWW  
 Lot Code – MXXX  
 Serial Number – ZZZ

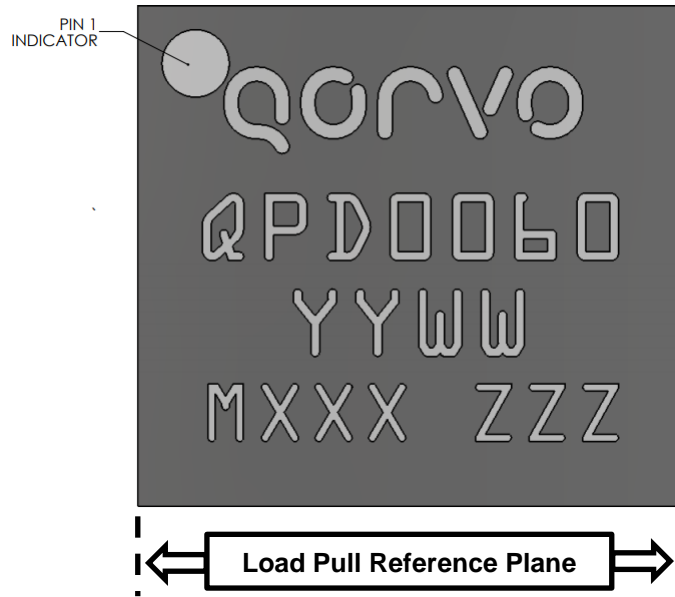

**Package Dimensions**

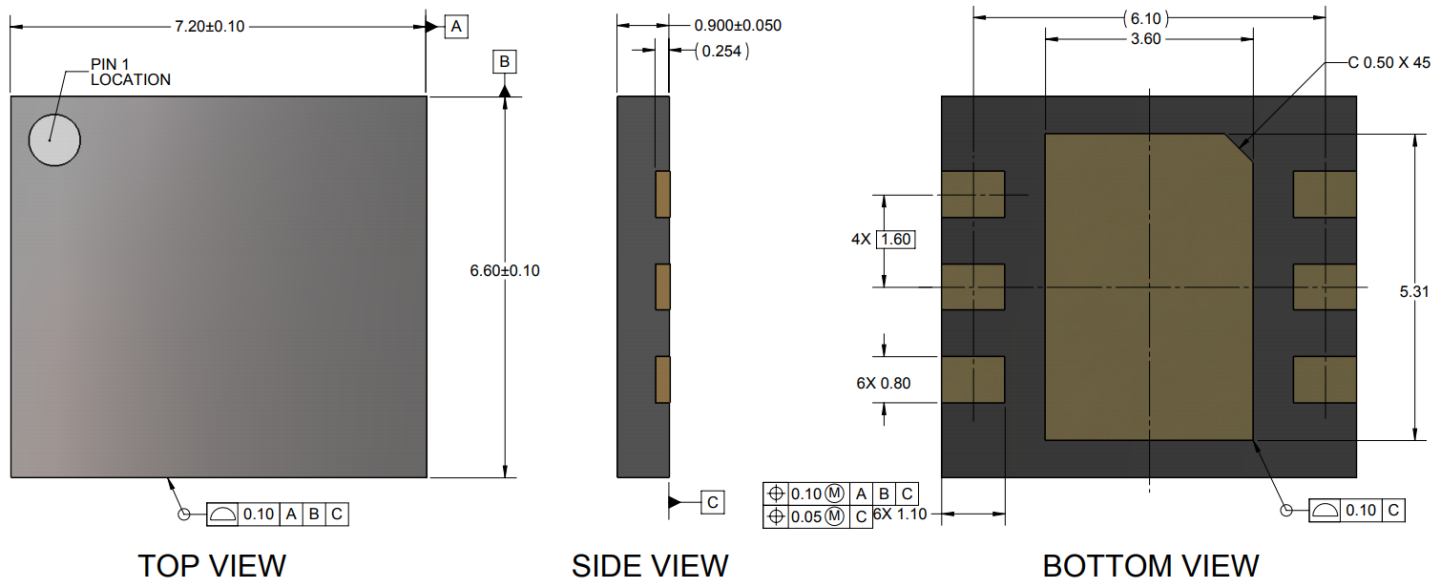

Notes:

1. Dimensions are in millimeters [inches]. Angles are in degrees.
2. Part is overmold encapsulated.
3. Contact plating is NiPdAu. Au thickness is 0.00254 to 0.01501 μm.
4. General tolerance is ±0.25.

## Pin Configuration and Description

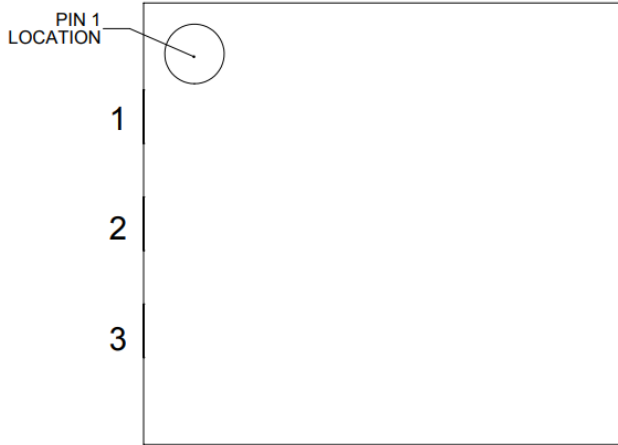

TOP VIEW

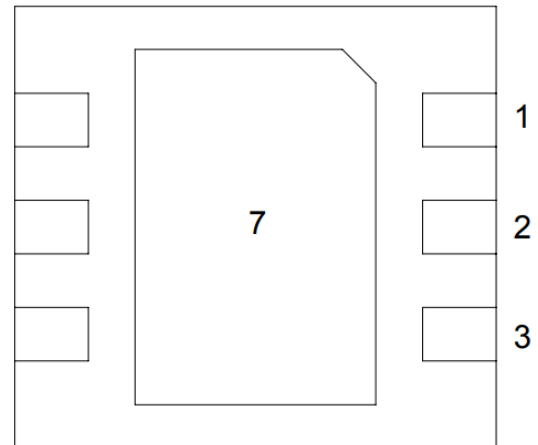

BOTTOM VIEW

Pin Number	Label	Description
1, 2, 3	RF IN, $V_G$	RF Input, Gate Bias
4, 5, 6	RF OUT, $V_D$	RF Output, Drain Bias
7 (Backside Paddle)	RF/DC GND	RF/DC Ground

## Bias Procedure

Bias On	Bias Off
<ol style="list-style-type: none"> <li>1. Turn ON <math>V_G</math> to <math>-4</math> V.</li> <li>2. Turn ON <math>V_D</math> to <math>+48</math> V.</li> <li>3. Slowly adjust <math>V_G</math> until <math>I_D</math> is set to 130 mA. (Typically, <math>V_G = -2.7</math> V.)</li> <li>5. Turn ON RF.</li> </ol>	<ol style="list-style-type: none"> <li>1. Turn OFF RF.</li> <li>2. Set <math>V_G</math> to <math>-5</math> V.</li> <li>3. Turn OFF <math>V_D</math>.</li> <li>4. Wait two (2) seconds to allow drain capacitor to discharge.</li> <li>5. Turn OFF <math>V_G</math>.</li> </ol>

Recommended Solder Temperature Profile

