

General Description

The QPD1004 is a 25W (P_{3dB}), 50Ω-input matched discrete GaN on SiC HEMT which operates from 30MHz to 1400MHz on a 50V supply rail. The integrated input matching network enables wideband gain and power performance, while the output can be matched on board to optimize power and efficiency for any region within the band. It is ideally suited for basestation, radar and communications applications and can support both CW and pulsed mode of operations.

The device is housed in an industry-standard 6 x 5 mm surface mount DFN package.

Lead-free and ROHS compliant

Evaluation boards are available upon request.

Functional Block Diagram

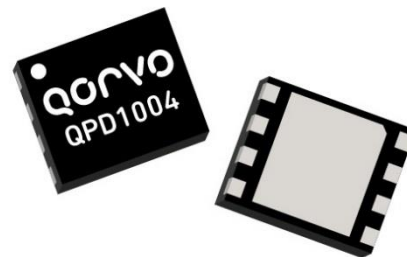
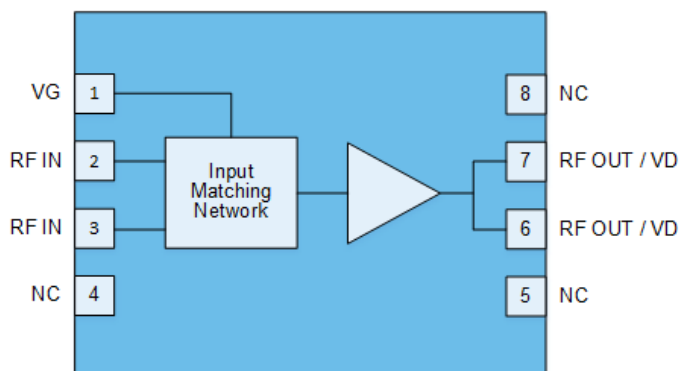

8 Pin DFN (6 x 5 x 0.85 mm)

Product Features

- Frequency: 30 to 1400 MHz
- Output Power (P_{3dB}): 40 W¹
- Linear Gain: 20.8 dB¹
- Typical PAE_{3dB}: 73.2%¹
- Operating Voltage: 50 V
- Low thermal resistance package
- CW and Pulse capable
- 6 x 5 mm package

Note 1: @ 1.0 GHz (Loadpull)

Applications

- Military radar
- Land mobile and military radio communications
- Test instrumentation
- Wideband or narrowband amplifiers
- Jammers

Ordering info

Part No.	Description
QPD1004S2	2 Piece Sample Bag
QPD1004SQ	25 Piece Sample Bag
QPD1004SR	100 Piece 7" Reel
QPD1004EVB1	30 – 1000 MHz Evaluation Board



Absolute Maximum Ratings^{1, 2}

Parameter	Rating	Units
Breakdown Voltage, BV_{DG}	145	V
Gate Voltage Range, V_G	-7 to +2	V
Drain Current, I_D	3.6	A
Gate Current Range, I_G^1	7.2	mA
Power Dissipation, CW, P_{DISS}	27.6	W
RF Input Power at 1 GHz, CW, 50 Ω , $T = 25^\circ\text{C}$	+29.7	dBm
Mounting Temperature (30 Seconds)	320	$^\circ\text{C}$
Storage Temperature	-65 to +150	$^\circ\text{C}$

Notes:

1. At Channel temperature of 200 $^\circ\text{C}$.
2. Operation of this device outside the parameter ranges given above may cause permanent damage.

Recommended Operating Conditions^{1, 2, 3}

Parameter	Min	Typ	Max	Units
Operating Temp. Range	-40	+25	+85	$^\circ\text{C}$
Drain Voltage Range, V_D	-	+50	+55	V
Drain Bias Current, I_{DQ}	-	50	-	mA
Drain Current, I_D	-	700	-	mA
Gate Voltage, V_G^3	-	-2.8	-	V
Power Dissipation, CW (P_D) ²	-	-	25.0	W

Notes:

1. Electrical performance is measured under conditions noted in the electrical specifications table. Specifications are not guaranteed over all recommended operating conditions.
2. Back plane of package at 85 $^\circ\text{C}$
3. To be adjusted to desired I_{DQ}

Pulsed Characterization – Load Pull Performance – Power Tuned¹

Parameter	Typical Values				Unit
	600	800	1000	1200	
Frequency, F	600	800	1000	1200	MHz
Linear Gain, G_{LIN}	21.0	21.2	20.1	18.4	dB
Output Power at 3dB compression point, P_{3dB}	45.7	45.9	46.0	45.7	dBm
Power-Added-Efficiency at 3dB compression point, PAE_{3dB}	62.4	61.5	63.5	59.5	%
Gain at 3dB compression point	18.0	18.2	17.1	15.4	dB

Notes:

1. Test conditions unless otherwise noted: $V_D = +50$ V, $I_{DQ} = 50$ mA, Temp = +25 °C

Pulsed Characterization – Load Pull Performance – Efficiency Tuned¹

Parameter	Typical Values				Unit
	600	800	1000	1200	
Frequency	600	800	1000	1200	MHz
Linear Gain, G_{LIN}	22.6	22.0	20.8	18.8	dB
Output Power at 3dB compression point, P_{3dB}	43.5	44.8	44.9	45.0	dBm
Power-Added-Efficiency at 3dB compression point, PAE_{3dB}	73.7	68.6	73.2	65.0	%
Gain at 3dB compression point, G_{3dB}	19.6	19.0	17.8	15.8	dB

Notes:

- 1- Test conditions unless otherwise noted: $V_D = +50$ V, $I_{DQ} = 50$ mA, Temp = +25 °C

RF Characterization – 30 – 1000 MHz EVB Performance At 500 MHz¹

Parameter	Min	Typ	Max	Unit
Linear Gain, G_{LIN}	–	21.0	–	dB
Output Power at 3dB compression point, P_{3dB}	–	44.1	–	dBm
Drain Efficiency at 3dB compression point, $DEFF_{3dB}$	–	65.1	–	%
Gain at 3dB compression point, G_{3dB}	–	18.0	–	dB

Notes:

1. $V_D = +50$ V, $I_{DQ} = 50$ mA, Temp = +25 °C, CW Signal

RF Characterization – Mismatch Ruggedness at 1000 MHz^{1, 2}

Symbol	Parameter	dB Compression	Typical
VSWR	Impedance Mismatch Ruggedness	3	10:1

Notes:

- 1- Test conditions unless otherwise noted: $T_A = 25$ °C, $V_D = 50$ V, $I_{DQ} = 50$ mA
- 2- Driving input power is determined at CW compression under matched condition at EVB output connector.

Thermal and Reliability Information – CW¹

Peak IR Surface Temperature vs. Dissipated Power
 Surface of DFN Base Fixed @ 85°C

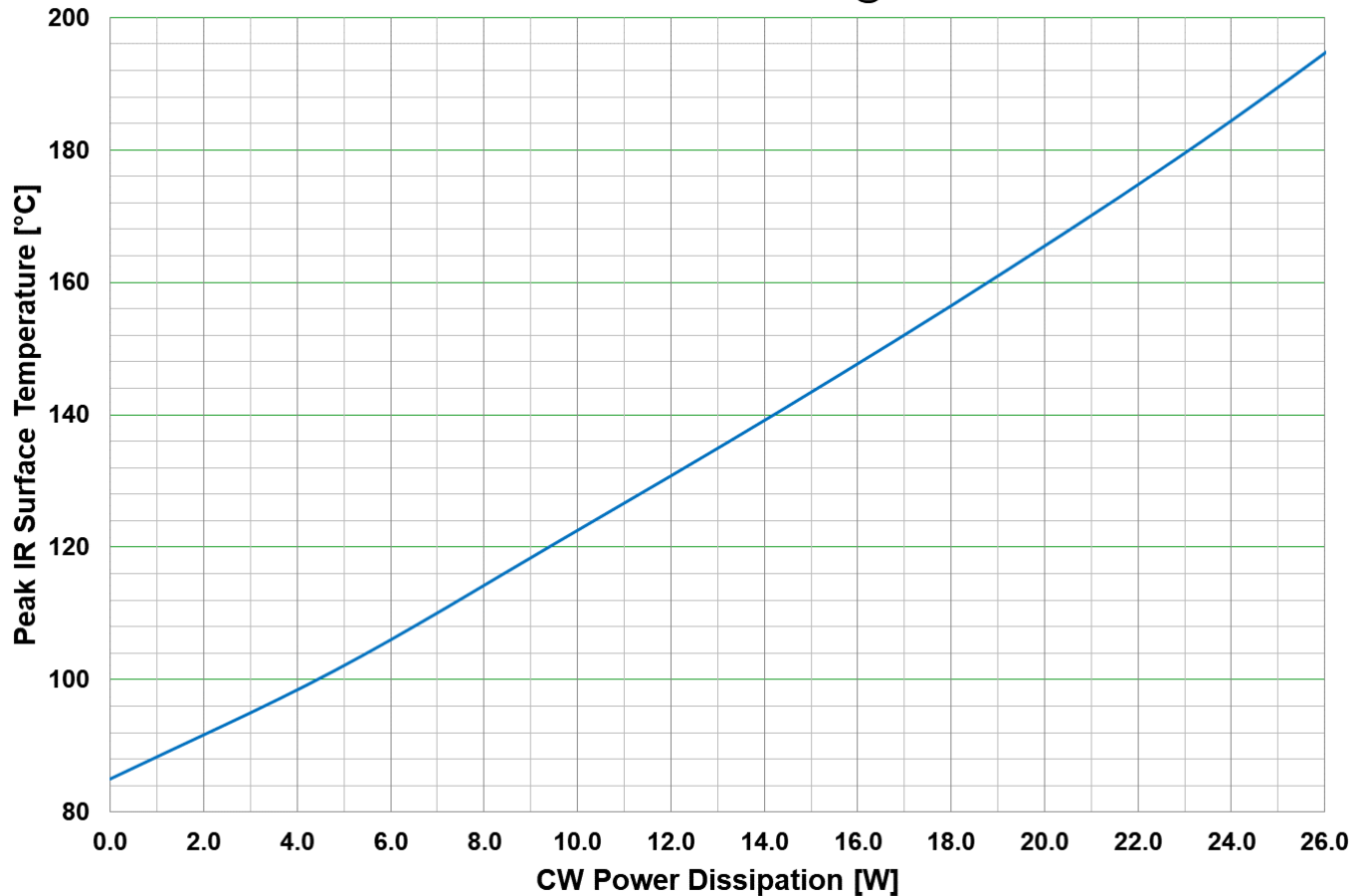

Parameter	Conditions	Values	Units
Thermal Resistance, IR ¹ (θ_{JC})	85 °C back side temperature	3.9	°C/W
Peak IR Surface Temperature ¹ (T_{CH})	16 W Pdiss, CW	148	°C

Notes:

1- Refer to the following document: [GaN Device Channel Temperature, Thermal Resistance, and Reliability Estimates](#)

Load Pull Smith Charts^{1,2}

Notes:

1. $V_d = 50\text{ V}$, $I_{BQ} = 50\text{ mA}$, Pulsed signal with 100 us pulse width and 10 % duty cycle.
2. See page 15 for load pull and source pull reference planes.

0.8 GHz, Load-pull

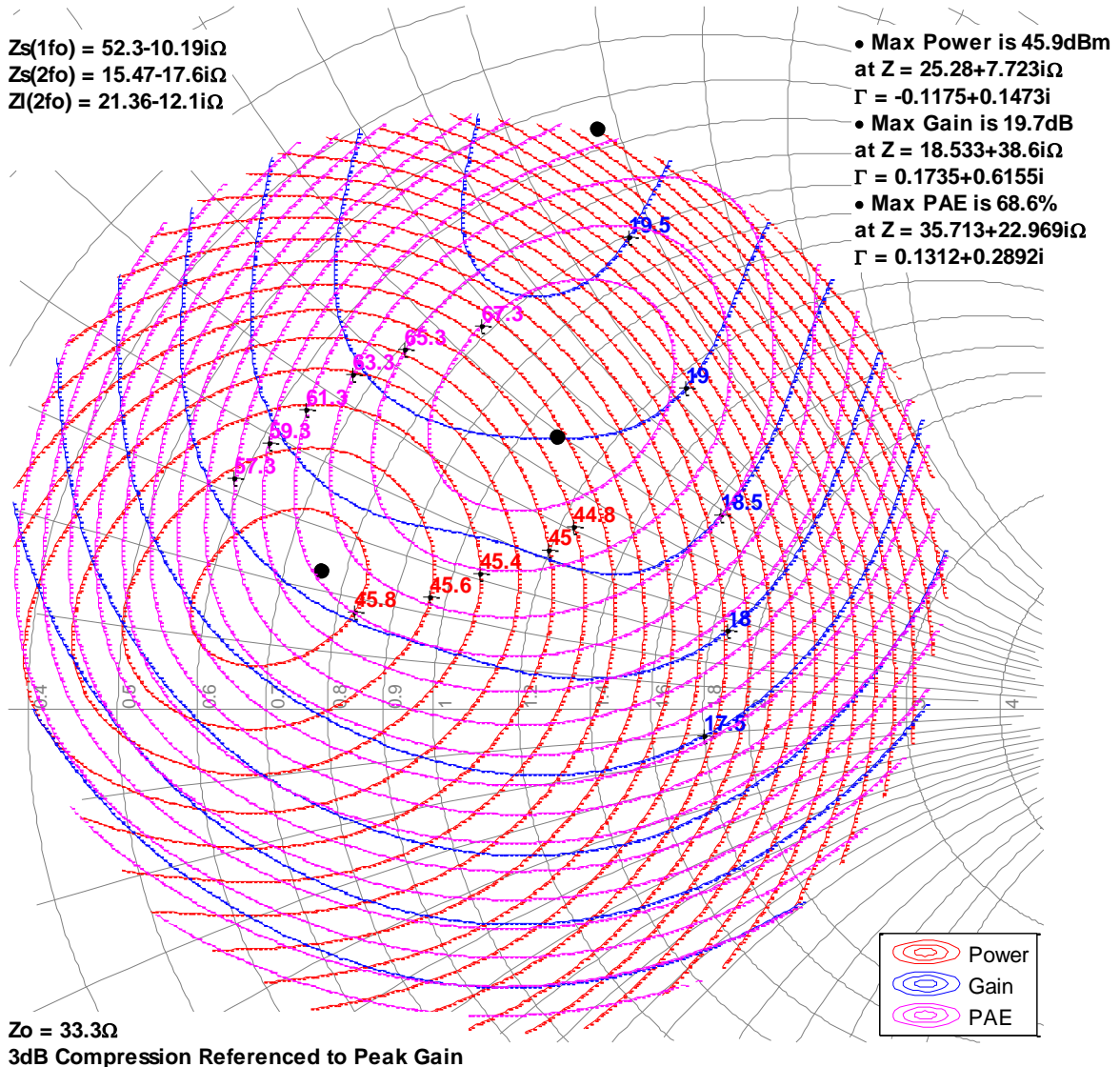

Load Pull Smith Charts^{1, 2}

Notes:

1. $V_d = 50\text{ V}$, $I_{BQ} = 50\text{ mA}$, Pulsed signal with 100 us pulse width and 10 % duty cycle.
2. See page 15 for load pull and source pull reference planes.

1 GHz, Load-pull

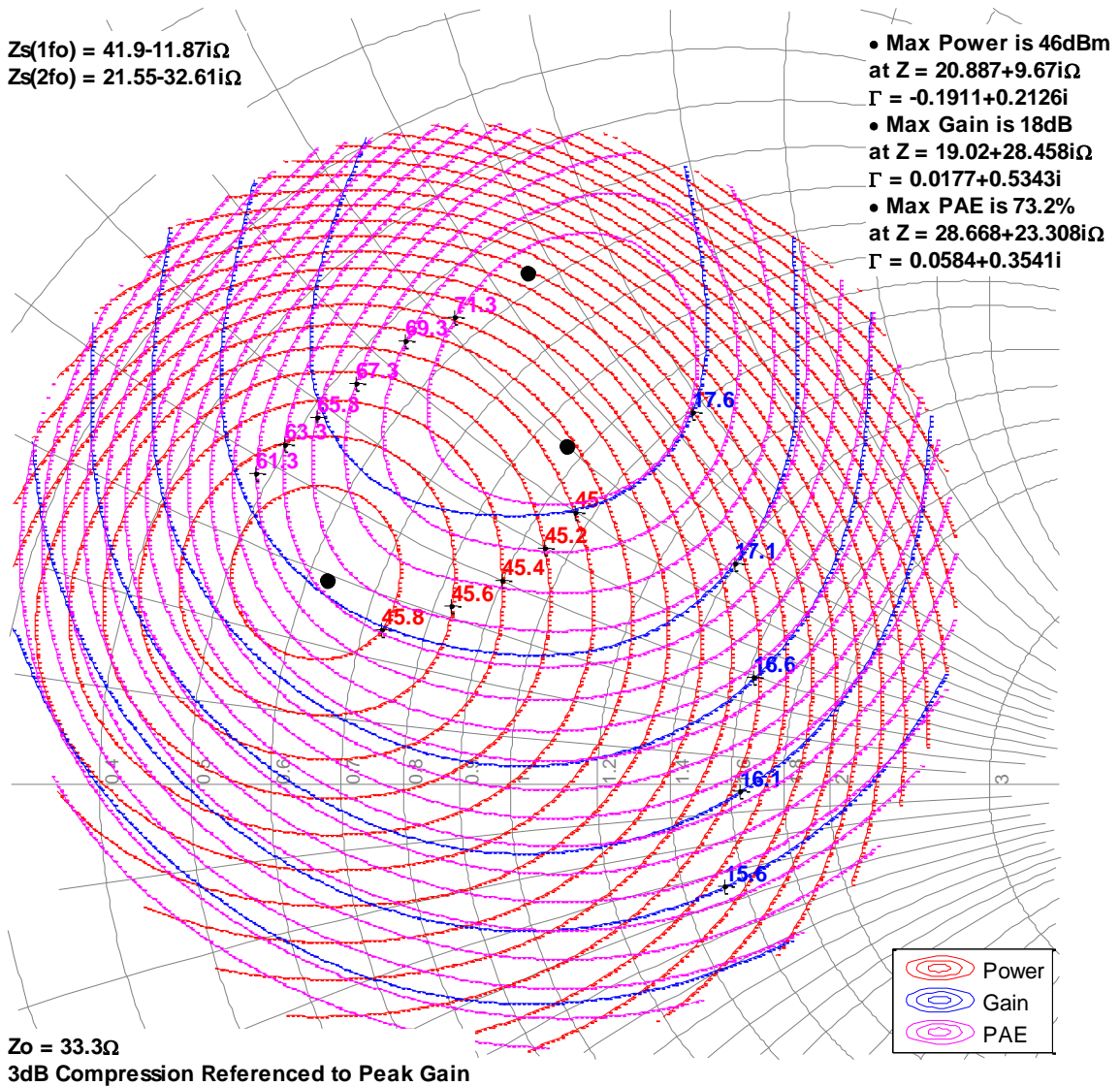

Load Pull Smith Charts^{1, 2}

Notes:

1. $V_d = 50\text{ V}$, $I_{bq} = 50\text{ mA}$, Pulsed signal with 100 us pulse width and 10 % duty cycle.
2. See page 15 for load pull and source pull reference planes.

1.2 GHz, Load-pull

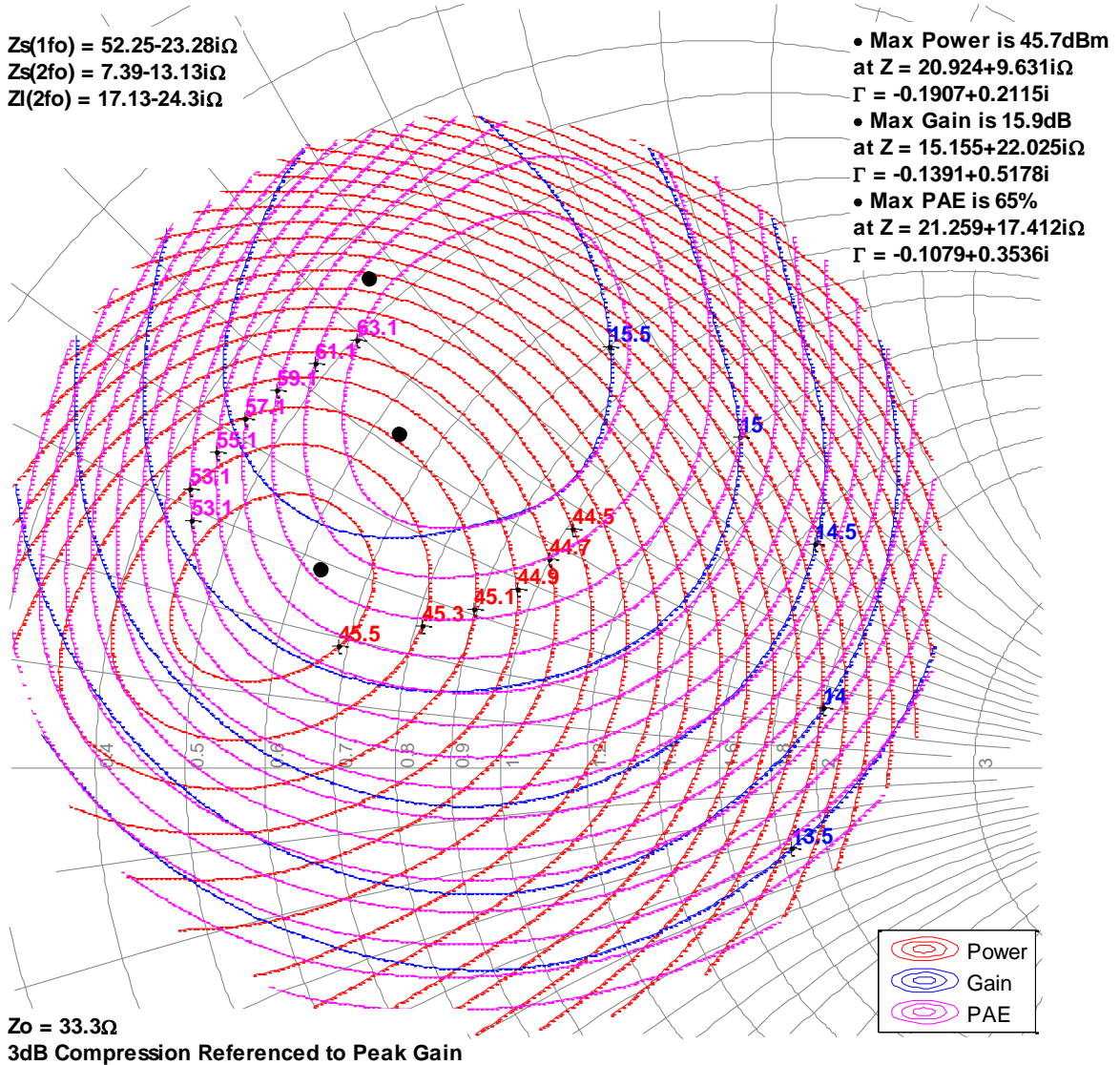

Typical Performance – Load Pull Drive-up

Notes:

1. Pulsed signal with 100 us pulse width and 10 % duty cycle, $V_d = 50\text{ V}$, $I_{DQ} = 50\text{ mA}$
2. See page 15 for load pull and source pull reference planes where the performance was measured.

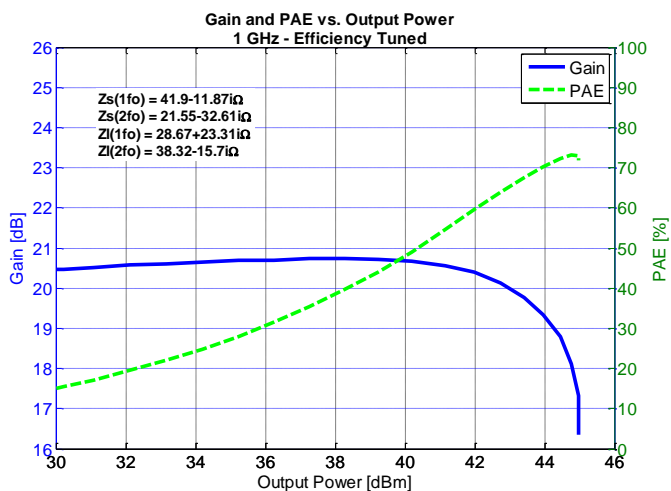
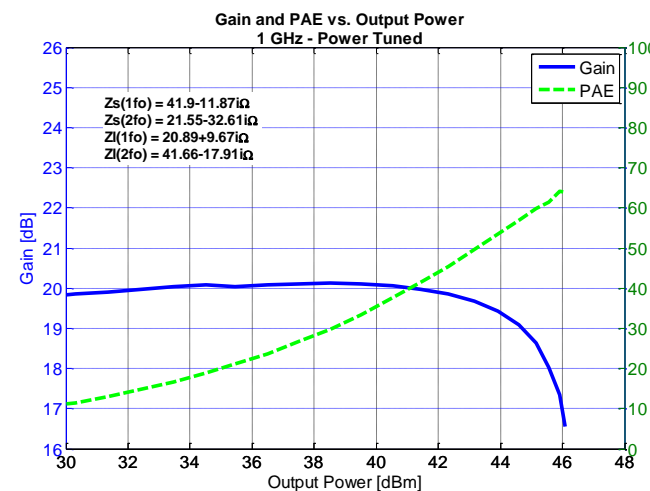
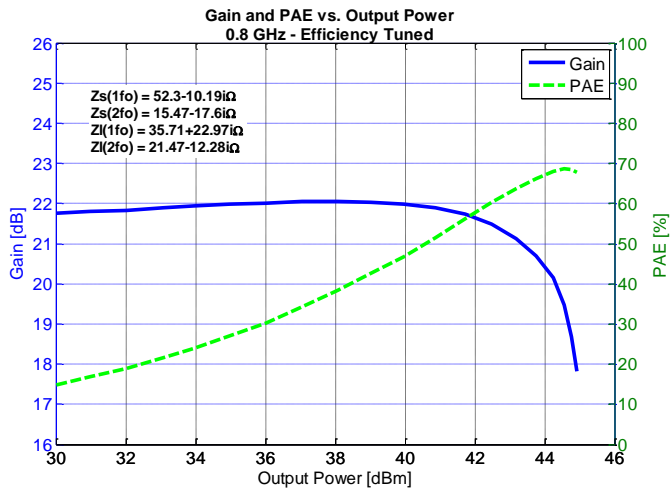
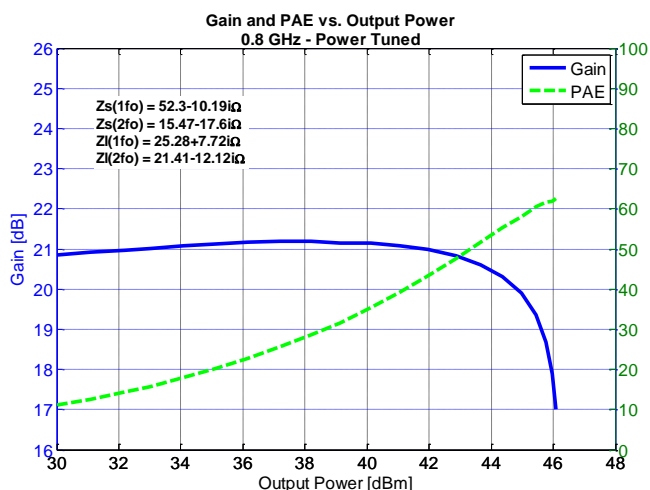
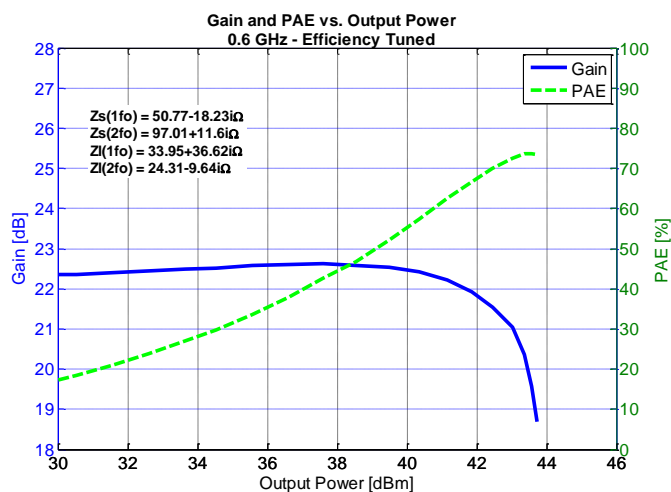
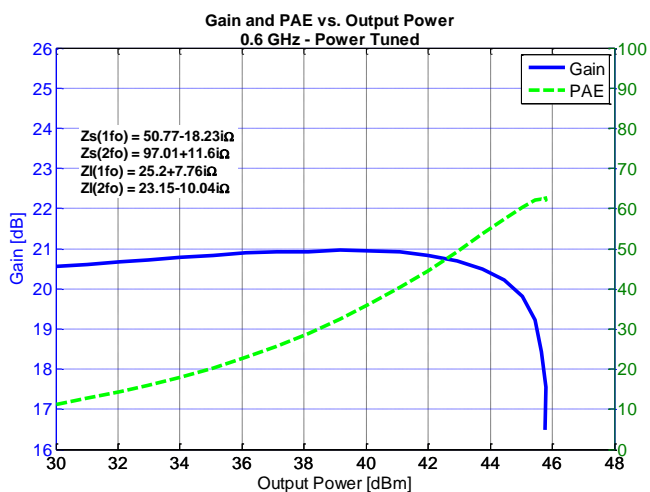

Typical Performance – Load Pull Drive-up

Notes:

1. Pulsed signal with 100 us pulse width and 10 % duty cycle, $V_d = 50\text{ V}$, $I_{DQ} = 50\text{ mA}$
2. See page 15 for load pull and source pull reference planes where the performance was measured.

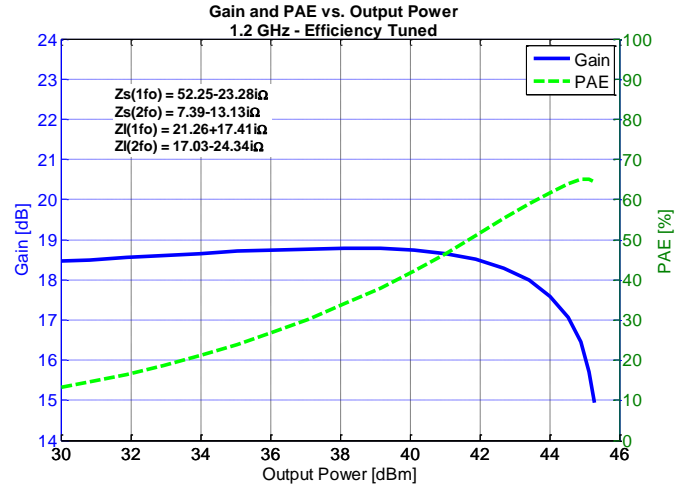
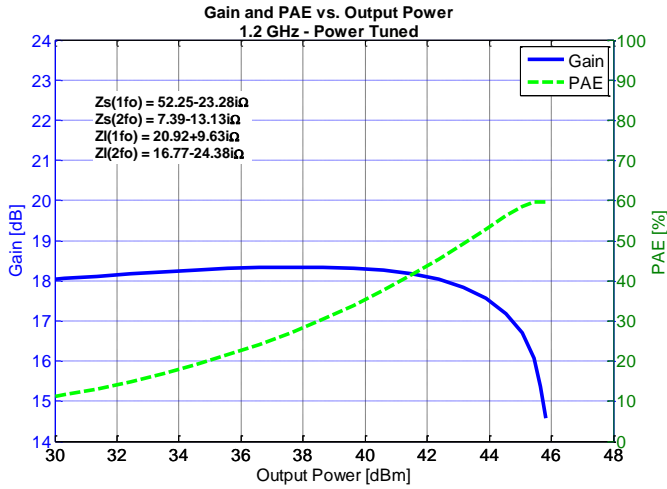

Power Driveup Performance Over Temperatures of 30 – 1000 MHz EVB¹

Notes:

1- $V_d = 50\text{ V}$, $I_{bq} = 50\text{ mA}$, CW Signal

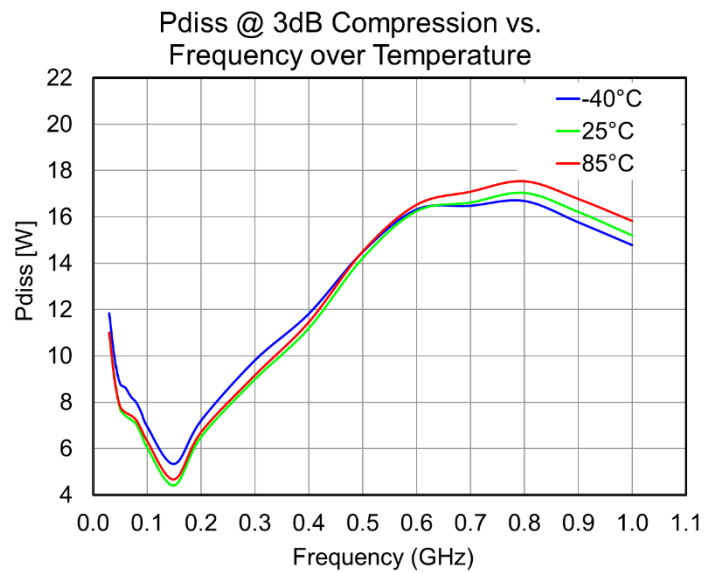
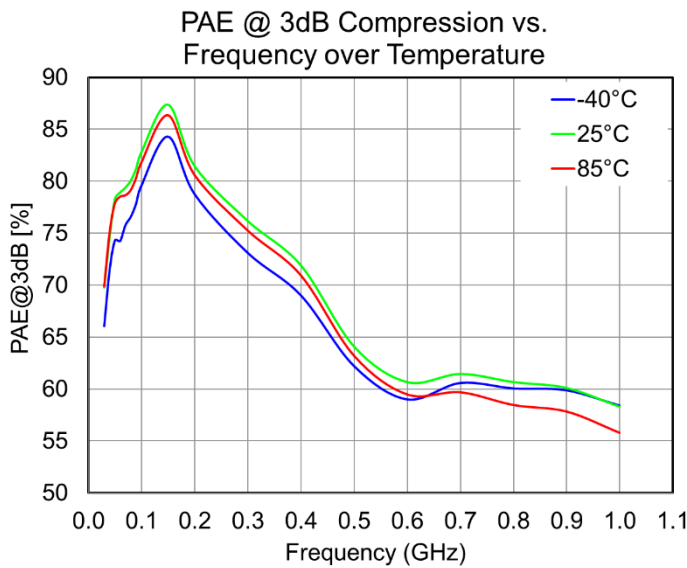
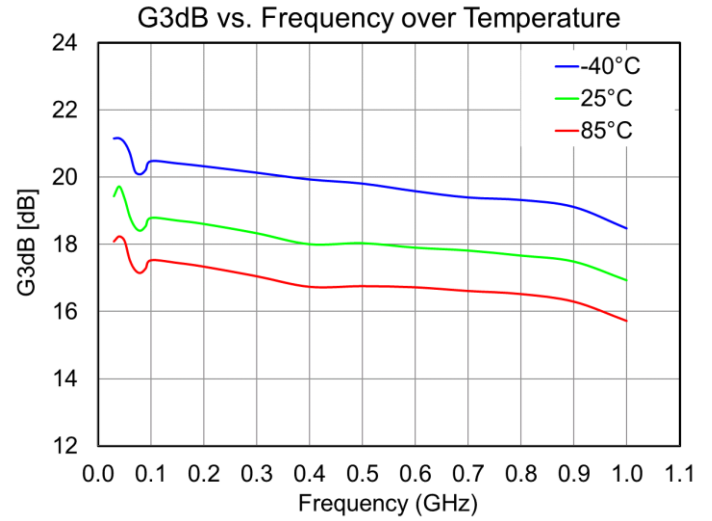
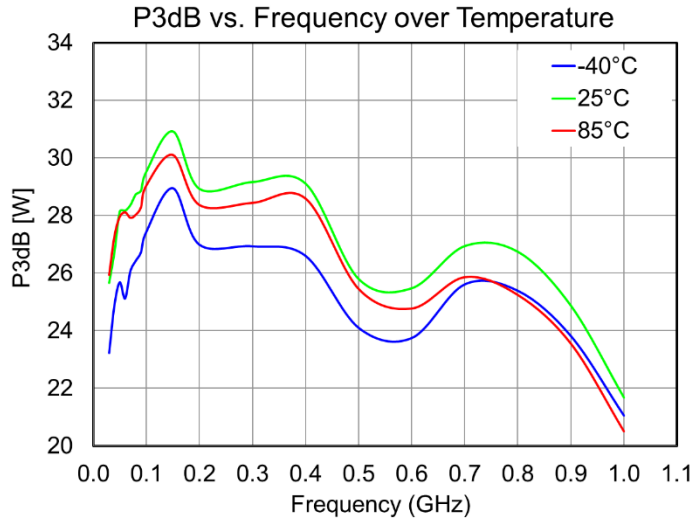

Power Driveup Performance at 25 °C of 30 – 1000 MHz EVB¹

Notes:

- 1- $V_d = 50\text{ V}$, $I_{bq} = 50\text{ mA}$, CW Signal

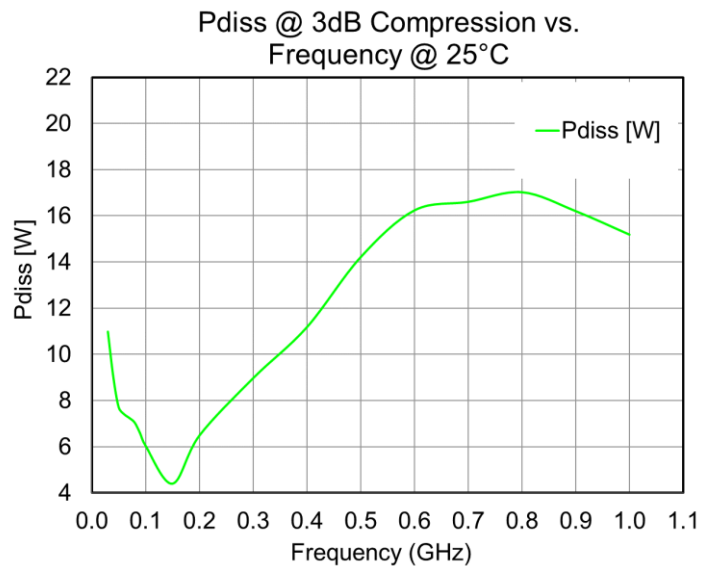
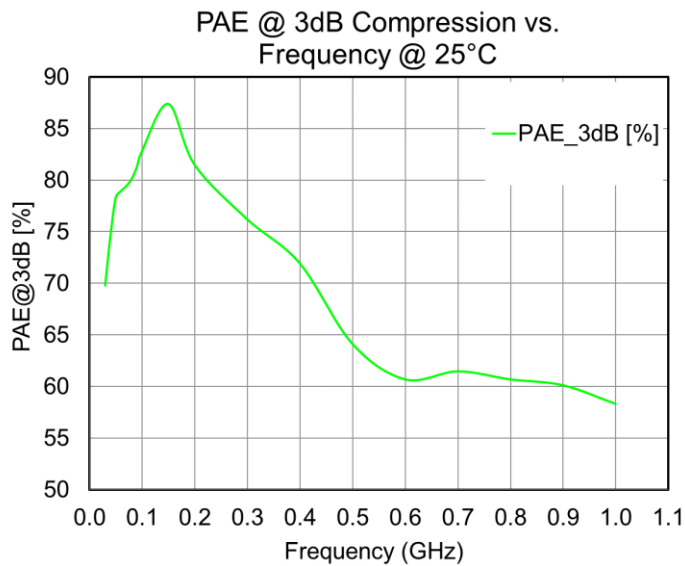
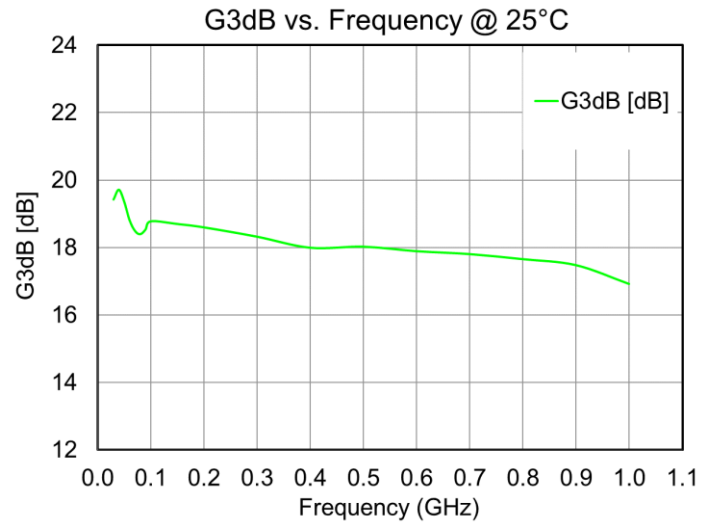
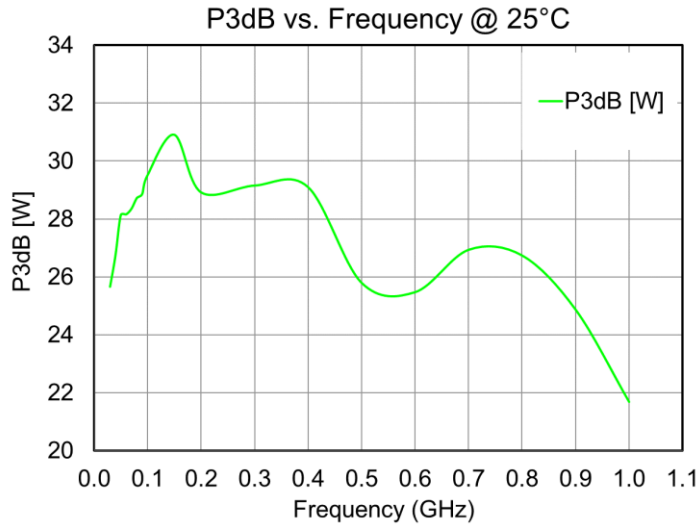

Two-Tone Performance at 25 °C of 30 – 1000 MHz EVB¹

Notes:

- 1- Center Frequency = 450 MHz. Tone Separation = 1 MHz.

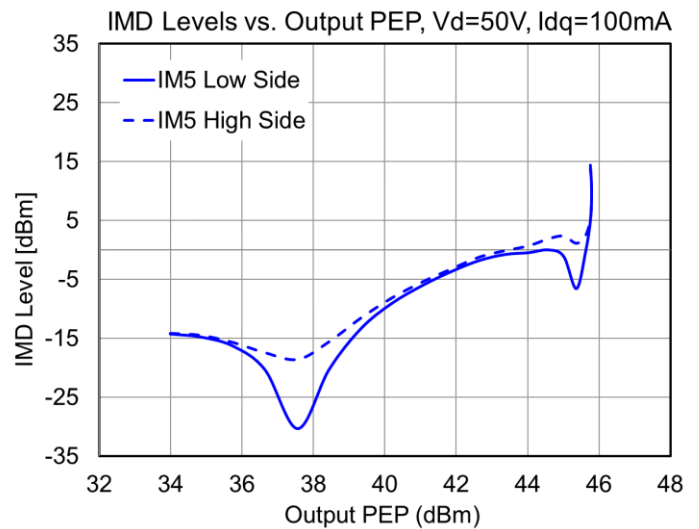
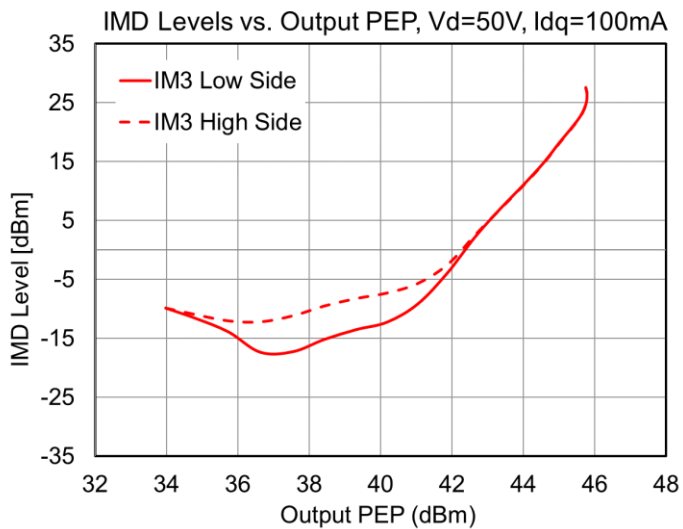
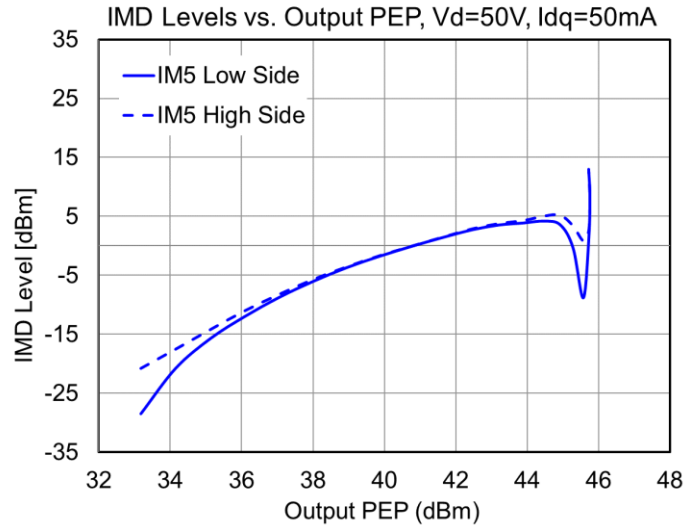
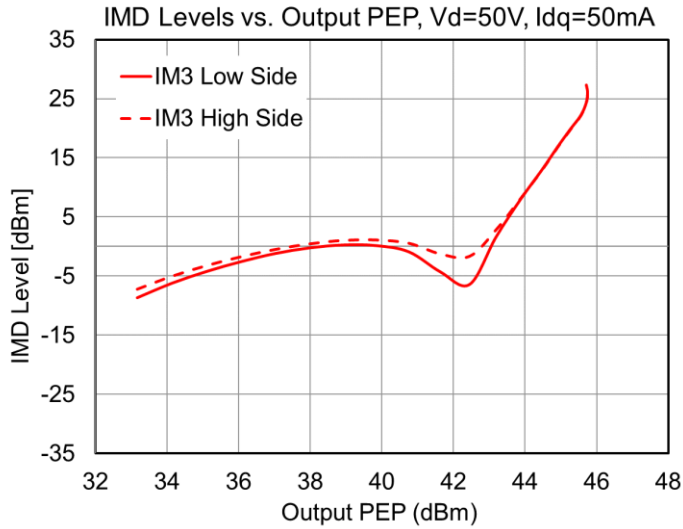

PCB Layout – 30 – 1000 MHz EVB¹

Notes:

- 1- PCB Material is RO4350B, 20 mil thick substrate, 0.5 oz. copper each side.

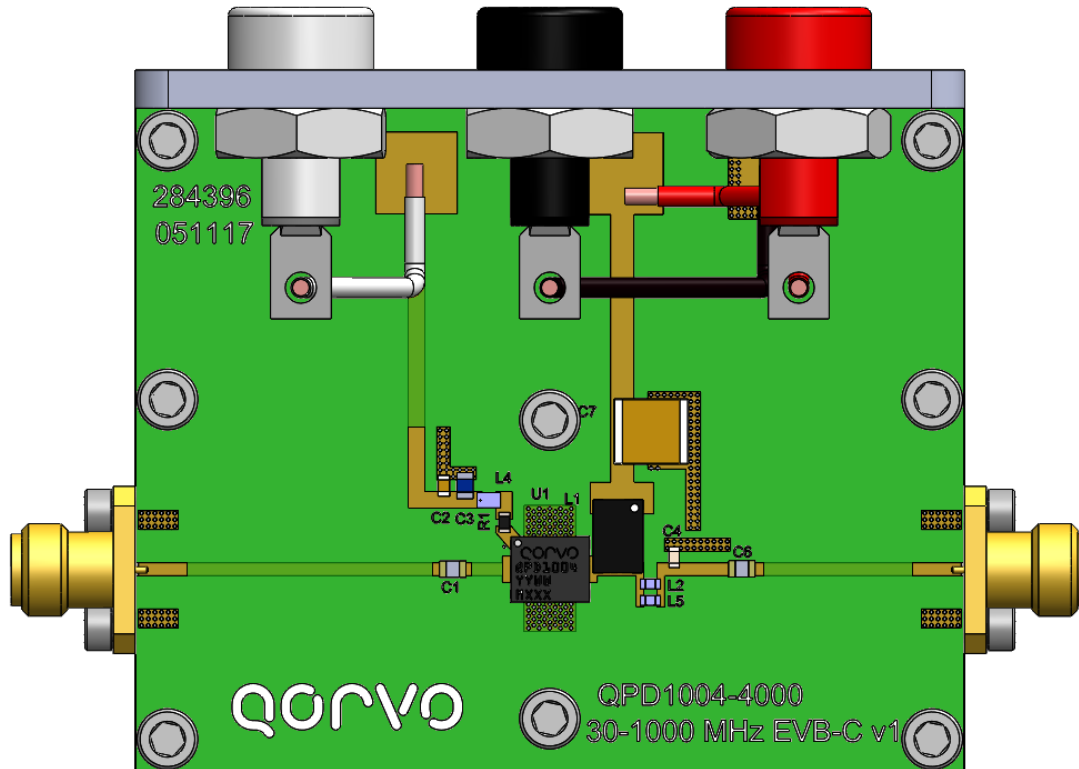

Bill Of material – 30 – 1000 MHz EVB

Ref Des	Value	Description	Manufacturer	Part Number
C1, C6	2400 pF	X7R 50V 15% 0805 Capacitor	DLI	C08BL242X-5UN-X0T
C2	10 nF	X7R 16V 10% 0603 Capacitor	AVX	0603YC103KAT2A
C3	10 uF	X7R 10V 10% 0805 Capacitor	Murata	GRM21BR71A106KE51L
C4	2.0 pF	C0G 250VDC ± 0.05 pF Capacitor	ATC	600S2R0AT250X
C7	4.7 uF	X7R 100V 10% 2220 Capacitor	Murata	GRM55ER72A475KA01L
L1	0.53 uH	Conical ± 5% 1060 mA Inductor	Coilcraft	BCR-531JLB
L2	15 nH	0603 ± 5% 1.9 A Inductor	Coilcraft	0603HC-15NXJLW
L4	1000 nH	0603 ± 2% 400 mA Inductor	Coilcraft	0603LS-102XGLC
L5	12 nH	0603 ± 5% 1.1 A Inductor	Coilcraft	0603HP-12NXGLW
J1 – J2	–	SMA Panel Mount 4-hole Jack	Gigalane	PSF-S00-000
R1	10 Ohm	0603 1% Thick Film Resistor	TTI Inc	CRCW060310R0JNEA

Pin Layout ¹

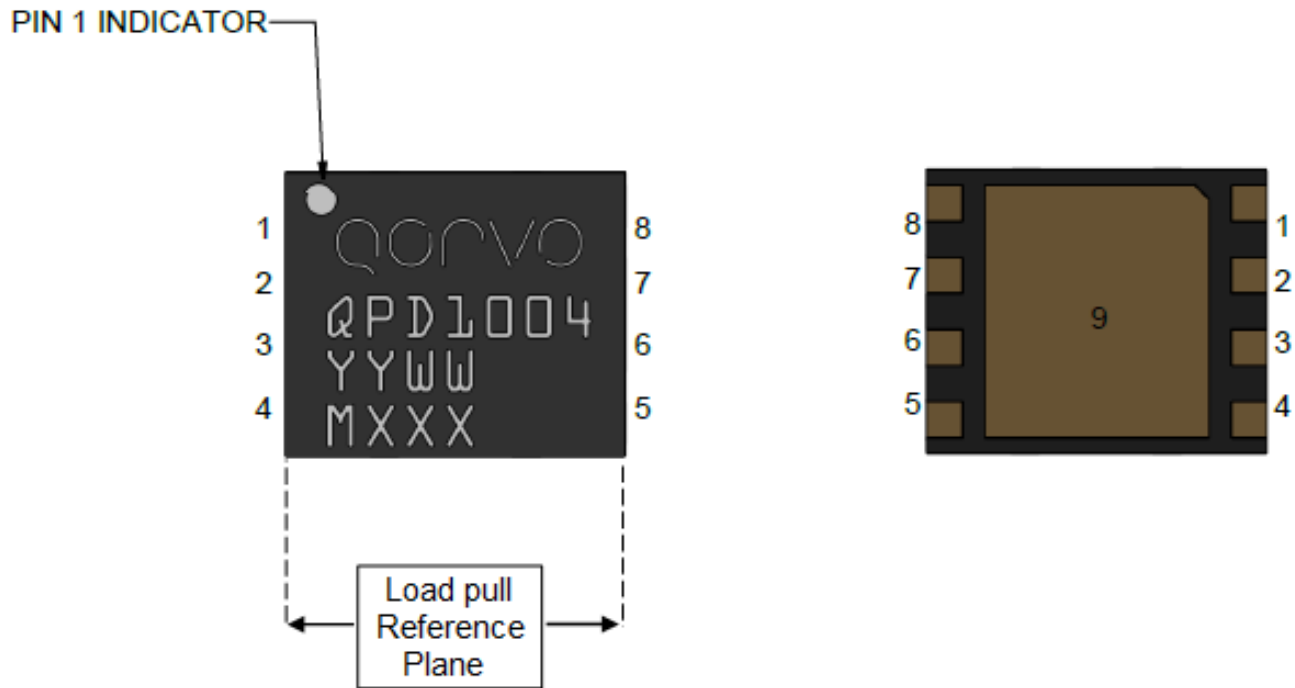

Notes:

1. The QPD1004 will be marked with the “QPD1004” designator and a lot code marked below the part designator. The “YY” represents the last two digits of the calendar year the part was manufactured, the “WW” is the work week of the assembly lot start, the “MXXX” is the batch ID.

Pin Description

Pin	Symbol	Description
1	VG	Gate Voltage
2, 3	RF IN	RF Input (Do not put DC)
4, 5, 8	NC	Not Connected
6, 7	RF OUT / VD	RF Output / Drain voltage
9	GND	Source to be connected to ground

Mechanical Drawing

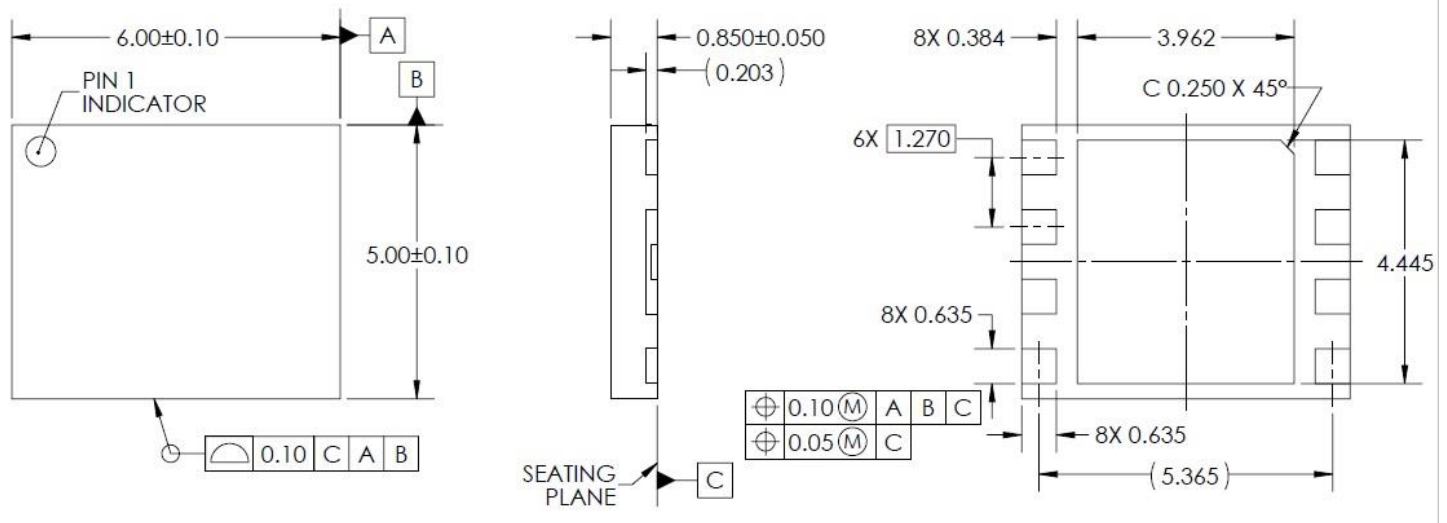

Notes:

1. All dimensions are in mm, unless otherwise noted.

Bias-up Procedure	Bias-down Procedure
1. Set V_G to -4 V.	1. Turn off RF signal.
2. Set ID current limit to 100 mA.	2. Turn off VD
3. Apply 50 V VD.	3. Wait 2 seconds to allow drain capacitor to discharge
4. Slowly adjust VG until ID is set to 50 mA.	4. Turn off VG
5. Set ID current limit to 1.5 A	
6. Apply RF.	

Tape and Reel Information – Carrier and Cover Tape Dimensions

Tape and reel specifications for this part are also available on the Qorvo website.

Standard T/R size = 100 pieces on a 7" reel.

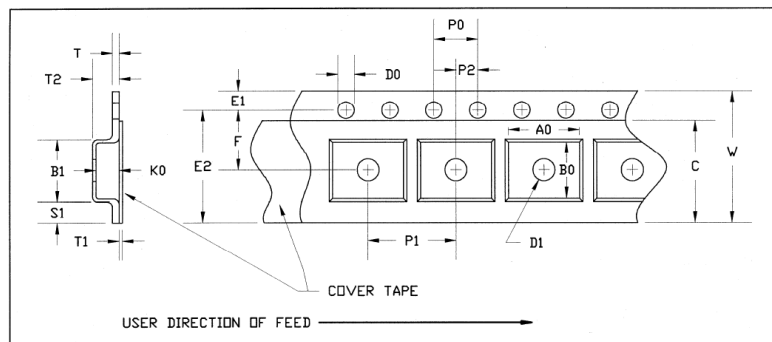
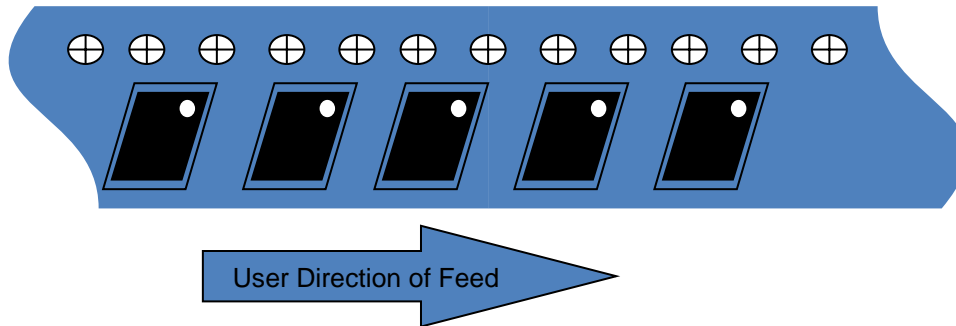

Feature	Measure	Symbol	Size (in)	Size (mm)
Cavity	Length	A0	0.209	5.3
	Width	B0	0.248	6.3
	Depth	K0	0.047	1.2
	Pitch	P1	0.315	8.0
Centerline Distance	Cavity to Perforation - Length Direction	P2	0.079	2.0
	Cavity to Perforation - Width Direction	F	0.217	5.50
Cover Tape	Width	C	0.362	9.20
Carrier Tape	Width	W	0.472	12.0

Tape and Reel Information – Reel Dimensions

Packaging reels are used to prevent damage to devices during shipping and storage, loaded carrier tape is typically wound onto a plastic take-up reel. The reel size is 7" diameter. The reels are made from high-impact injection-molded polystyrene (HIPS), which offers mechanical and ESD protection to packaged devices.

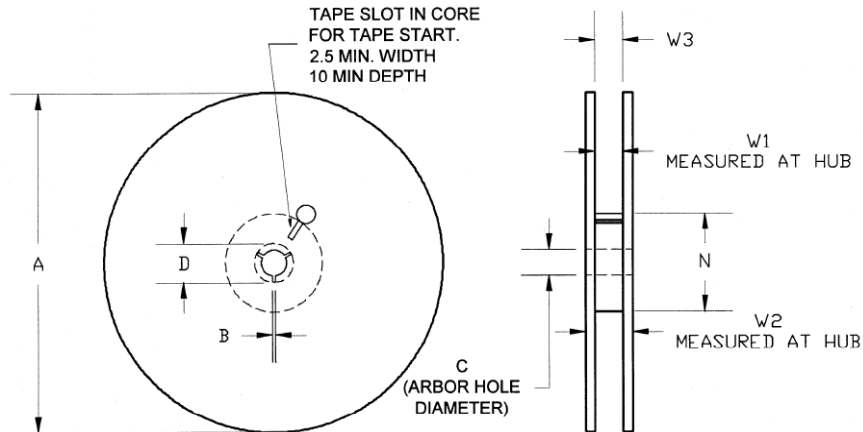

Feature	Measure	Symbol	Size (in)	Size (mm)
Flange	Diameter	A	6.969	177.0
	Thickness	W2	0.724	18.4
	Space Between Flange	W1	0.488	12.4
Hub	Outer Diameter	N	2.283	58.0
	Arbor Hole Diameter	C	0.512	13.0
	Key Slit Width	B	0.079	2.0
	Key Slit Diameter	D	0.795	20.2

Tape and Reel Information – Tape Length and Label Placement

Tape and reel specifications for this part are also available on the Qorvo website. Standard T/R size = 100 pieces on a 7" reel.

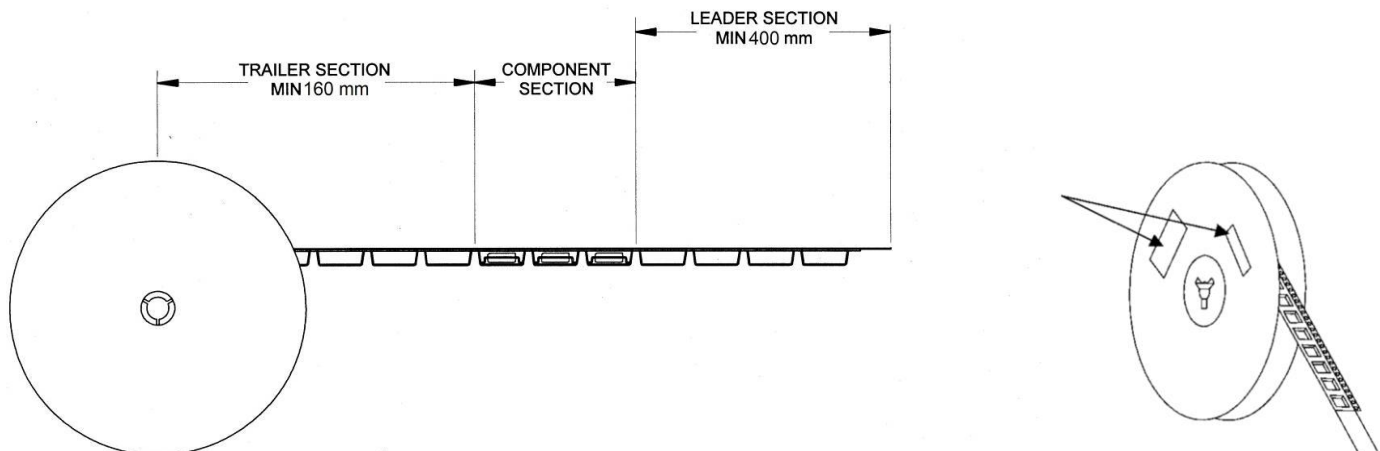
Notes:

1. Empty part cavities at the trailing and leading ends are sealed with cover tape. See EIA 481.
2. Labels are placed on the flange opposite the sprockets in the carrier tape.

Recommended Solder Temperature Profile

