

Product Overview

The QPD1018 is a 500 W (P_{3dB}) internally matched discrete GaN on SiC HEMT which operates from 2.7 to 3.1 GHz on a 50V supply rail. The device is GaN IMFET fully matched to 50 Ω in an industry standard air cavity package and is ideally suited for military radar.

ROHS compliant.

Evaluation boards are available upon request.



17.40 x 24.00 x 4.31 mm

Functional Block Diagram

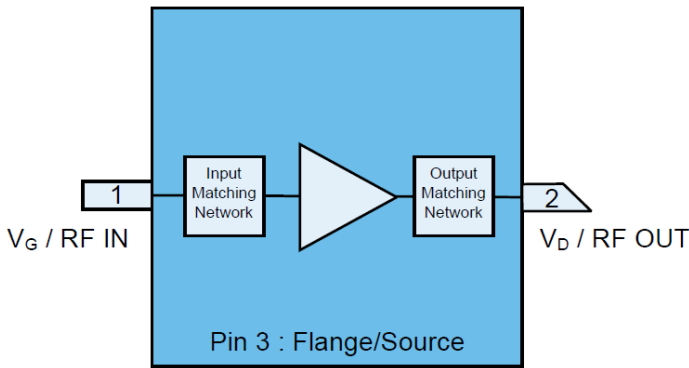

Key Features¹

- Frequency: 2.7 to 3.1 GHz
- Output Power (P_{3dB})¹: 575 W
- Linear Gain¹: 17.7 dB
- Typical PAE_{3dB}¹: 67.9%
- Operating Voltage: 50 V
- Low thermal resistance package
- Pulse capable

Note 1: @ 2.9 GHz

Applications

- Military radar
- Civilian radar
- Test instrumentation

Ordering Information

Part No.	Description
QPD1018	Tray of 18 QPD1018
QPD1018S2	Pack of 2 QPD1018
QPD1018EVB	2.7 – 3.1 GHz EVB



QPD1018

500W, 50V, 2.7 – 3.1 GHz, GaN RF IMFET

Absolute Maximum Ratings¹

Parameter	Rating	Units
Breakdown Voltage, BV_{DG}	+145	V
Gate Voltage Range, V_G	-7 to +2	V
Drain Current	20	A
Gate Current Range, I_G	See page 4.	mA
Power Dissipation, 10% DC 100 uS PW, P_D , $T = 85^\circ\text{C}$	522	W
RF Input Power, 10% DC 100 uS PW, 2.9 GHz, $T = 25^\circ\text{C}$	+49	dBm
Mounting Temperature (30 Seconds)	320	$^\circ\text{C}$
Storage Temperature	-65 to +150	$^\circ\text{C}$

Notes:

1. Operation of this device outside the parameter ranges given above may cause permanent damage.

Recommended Operating Conditions^{1, 2, 3, 4}

Parameter	Min	Typ	Max	Units
Operating Temp. Range	-40	+25	+85	$^\circ\text{C}$
Drain Voltage Range, V_D	+28	+50	+55	V
Drain Bias Current, I_{DQ}	-	750	-	mA
Drain Current, I_D	-	15	-	A
Gate Voltage, V_G ⁴	-	-2.8	-	V
Power Dissipation, Pulsed (P_D) ^{2, 3}	-	-	472	W

Notes:

1. Electrical performance is measured under conditions noted in the electrical specifications table. Specifications are not guaranteed over all recommended operating conditions.
2. Package base at 85°C
3. Pulse Width = 100 uS, Duty Cycle = 10%
4. To be adjusted to desired I_{DQ}

Pulsed Characterization – Load-Pull Performance – Power Tuned¹

Parameters	Typical Values			Unit
	2.7	2.9	3.1	
Frequency, F	2.7	2.9	3.1	GHz
Linear Gain, G_{LIN}	16.1	16.4	14.6	dB
Output Power at 3dB compression point, P_{3dB}	57.7	57.6	57.5	dBm
Power-Added-Efficiency at 3dB compression point, PAE_{3dB}	59.1	56.6	56.1	%
Gain at 3dB compression point	13.1	13.4	11.6	dB

Notes:

1. Test conditions unless otherwise noted: $V_D = 50\text{ V}$, $I_{DQ} = 750\text{ mA}$, $\text{Temp} = 25^\circ\text{C}$, 100 uS PW, 10% DC

Pulsed Characterization – Load-Pull Performance – Efficiency Tuned¹

Parameters	Typical Values			Unit
	2.7	2.9	3.1	
Frequency, F	2.7	2.9	3.1	GHz
Linear Gain, G_{LIN}	16.9	17.7	15.8	dB
Output Power at 3dB compression point, P_{3dB}	56.5	56.1	55.8	dBm
Power-Added-Efficiency at 3dB compression point, PAE_{3dB}	68.6	67.9	65.2	%
Gain at 3dB compression point, G_{3dB}	13.9	14.7	12.8	dB

Notes:

1. Test conditions unless otherwise noted: $V_D = 50\text{ V}$, $I_{DQ} = 750\text{ mA}$, $\text{Temp} = 25^\circ\text{C}$, 100 uS PW, 10% DC

RF Characterization – 2.7 – 3.1 GHz EVB Performance At 2.7 GHz¹

Parameter	Min	Typ	Max	Units
Linear Gain, G_{LIN}	–	16.6	–	dB
Output Power at 3dB compression point, P_{3dB}	–	56.7	–	dBm
Power-Added Efficiency at 3dB compression point, PAE_{3dB}	–	64.4	–	%
Gain at 3dB compression point, G_{3dB}	–	13.6	–	dB

Notes:

- $V_D = 50\text{ V}$, $I_{DQ} = 750\text{ mA}$, Temp = 25°C, 100 uS PW, 10% DC

RF Characterization – 2.7 – 3.1 GHz EVB Performance At 2.9 GHz¹

Parameter	Min	Typ	Max	Units
Linear Gain, G_{LIN}	–	16.8	–	dB
Output Power at 3dB compression point, P_{3dB}	–	56.6	–	dBm
Power-Added Efficiency at 3dB compression point, PAE_{3dB}	–	57.1	–	%
Gain at 3dB compression point, G_{3dB}	–	13.8	–	dB

Notes:

- $V_D = 50\text{ V}$, $I_{DQ} = 750\text{ mA}$, Temp = 25°C, 100 uS PW, 10% DC

RF Characterization – 2.7 – 3.1 GHz EVB Performance At 3.1 GHz¹

Parameter	Min	Typ	Max	Units
Linear Gain, G_{LIN}	–	15.4	–	dB
Output Power at 3dB compression point, P_{3dB}	–	56.8	–	dBm
Power-Added Efficiency at 3dB compression point, PAE_{3dB}	–	56.0	–	%
Gain at 3dB compression point, G_{3dB}	–	12.4	–	dB

Notes:

- $V_D = 50\text{ V}$, $I_{DQ} = 750\text{ mA}$, Temp = 25°C, 100 uS PW, 10% DC

RF Characterization – Mismatch Ruggedness at 2.9 GHz^{1, 2, 3}

Symbol	Parameter	dB Compression	Typical
VSWR	Impedance Mismatch Ruggedness	3	10:1

Notes:

- Test conditions unless otherwise noted: $T_A = 25^\circ\text{C}$, $V_D = 50\text{ V}$, $I_{DQ} = 750\text{ mA}$, 100 uS PW, 10% DC.
- Driving input power is determined at pulsed compression under matched condition at EVB output connector.
- No spur detected down to the noise floor of Spectrum Analyzer from 1 – 15GHz at $T_A = -40^\circ\text{C}$.

Maximum Gate Current

Maximum Gate Current vs. IR Surface Temperature

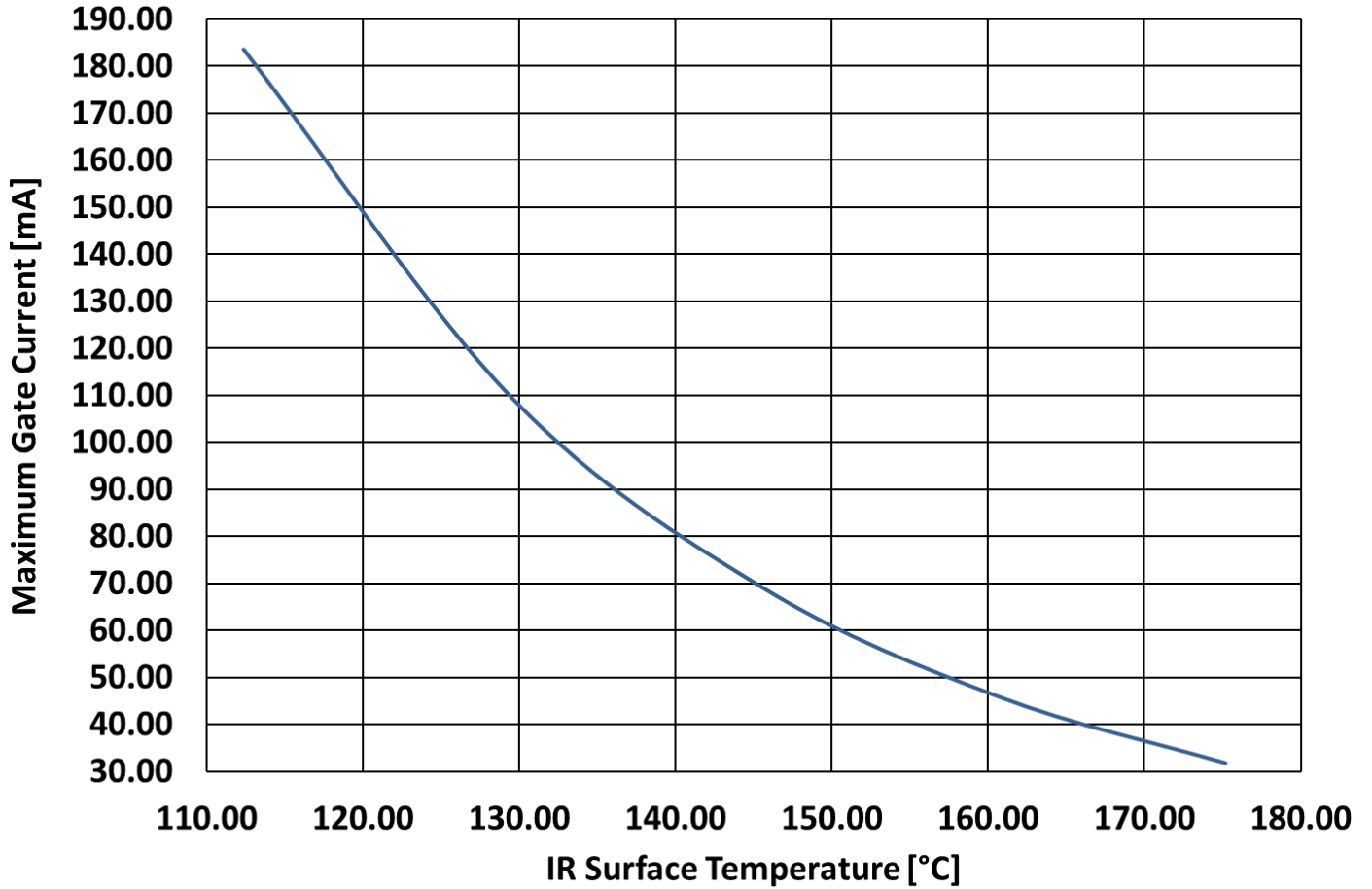

Thermal and Reliability Information – Pulsed¹

Peak IR Surface Temperature vs. Pulse Width
Pdiss = 346 W, Base Temperature @ 85°C

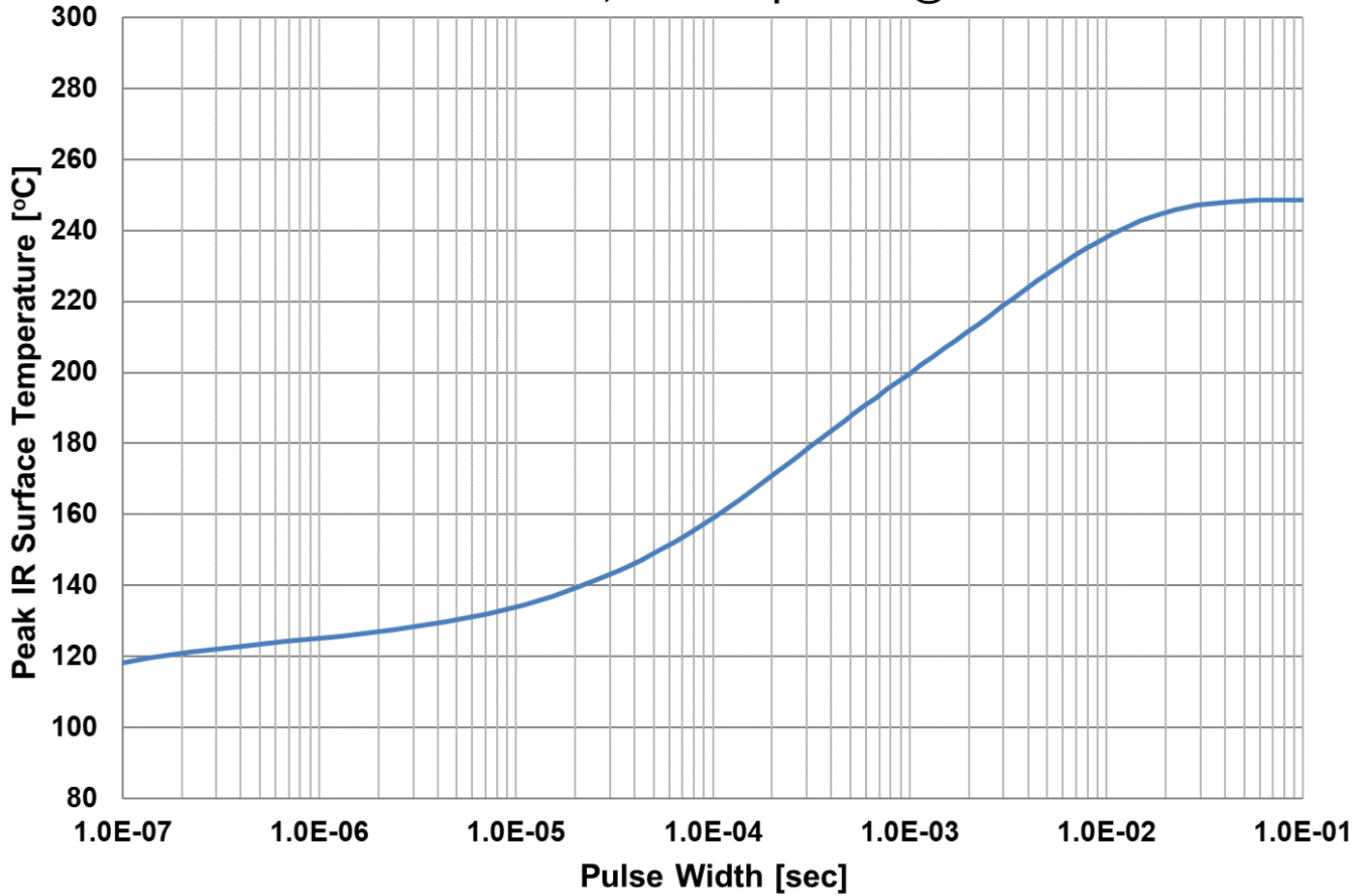

Parameter	Conditions	Values	Units
Thermal Resistance, IR ¹ (θ_{JC})	85°C back side temperature	0.33	°C/W
Peak IR Surface Temperature ¹ (T_{CH})	346 W Pdiss, 1 mS PW, 10% DC	200	°C

Notes:

1- Refer to the following document: [GaN Device Channel Temperature, Thermal Resistance, and Reliability Estimates](#)

Load-Pull Smith Charts^{1, 2, 3}

Notes:

1. $V_D = 50\text{ V}$, $I_{DQ} = 750\text{ mA}$, $100\text{ }\mu\text{s PW}$, 10% DC pulsed. Performance is at 3dB gain compression referenced to peak gain.
2. See page 12 for load-pull and source-pull reference planes. $50\text{-}\Omega$ load-pull TRL fixtures are built with 20-mil RO4350B material.
3. NaN means the impedances are either undefined or varying in load-pull system.

2.7GHz, Load-pull

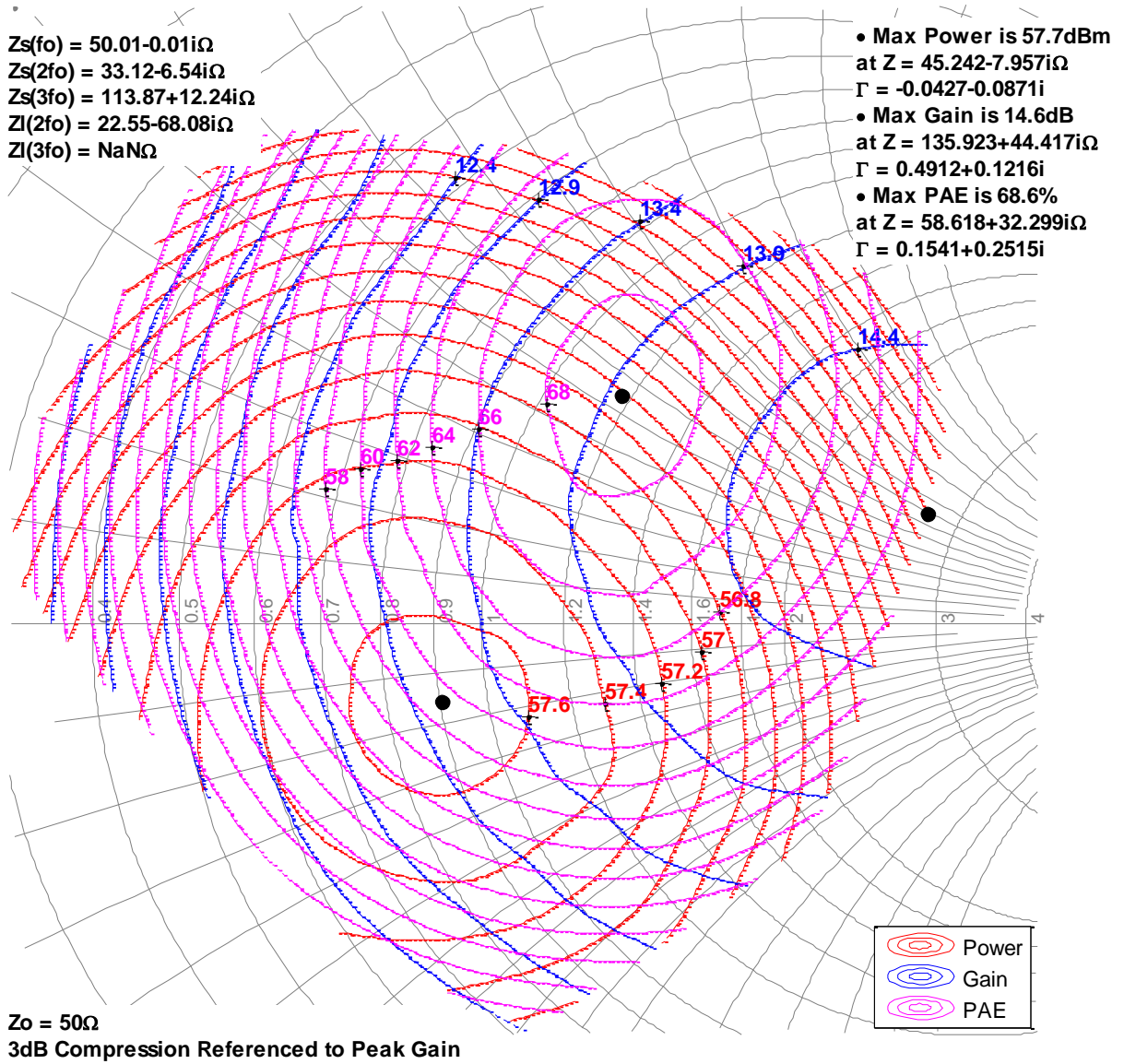

Load-Pull Smith Charts^{1, 2, 3}

Notes:

1. $V_D = 50\text{ V}$, $I_{DQ} = 750\text{ mA}$, 100 uS PW , 10% DC pulsed. Performance is at 3dB gain compression referenced to peak gain.
2. See page 12 for load-pull and source-pull reference planes. $50\text{-}\Omega$ load-pull TRL fixtures are built with 20-mil RO4350B material.
3. NaN means the impedances are either undefined or varying in load-pull system.

2.9GHz, Load-pull

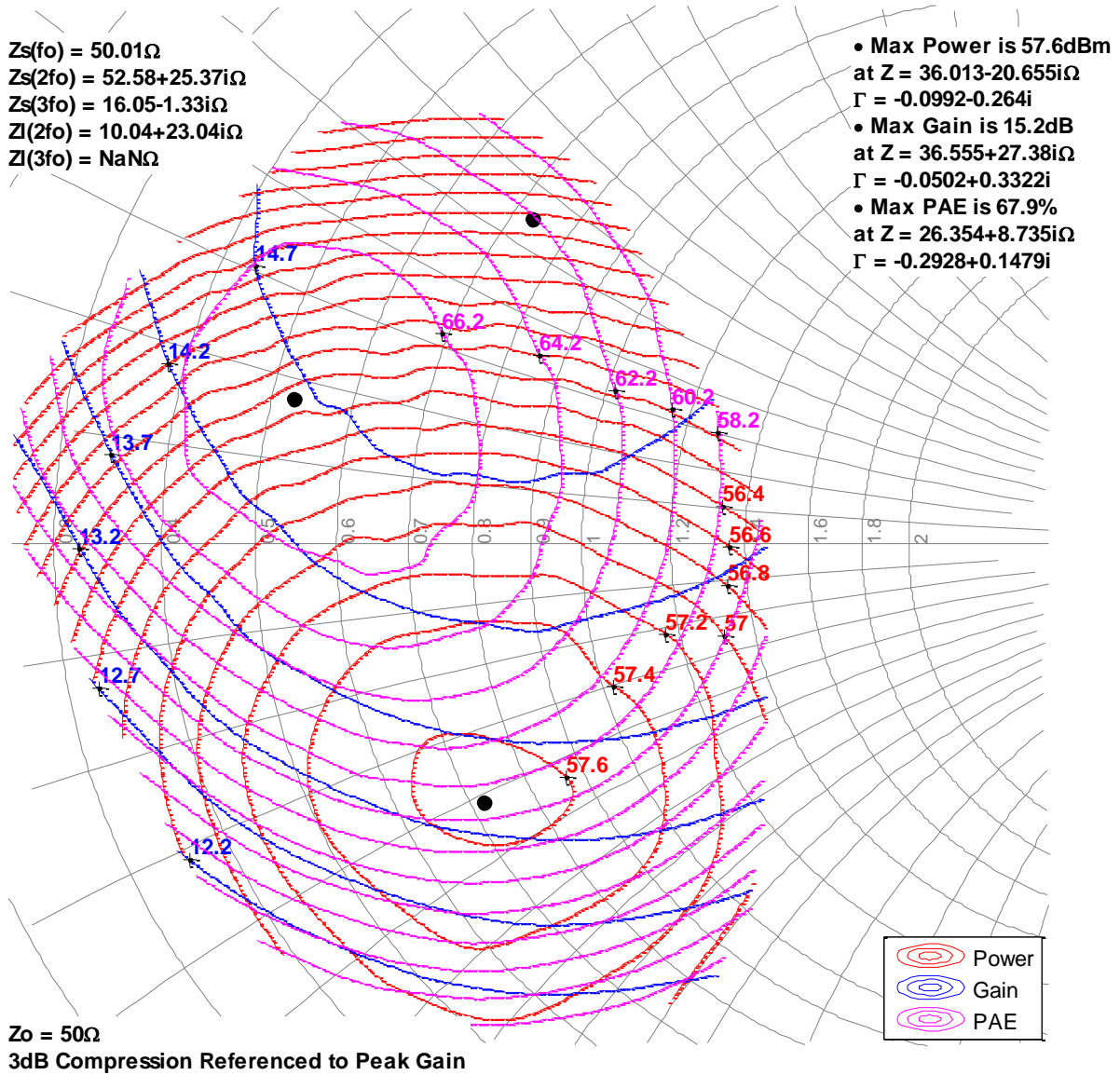

Load-Pull Smith Charts^{1, 2, 3}

Notes:

1. $V_D = 50\text{ V}$, $I_{DQ} = 750\text{ mA}$, $100\text{ }\mu\text{s PW}$, 10% DC pulsed. Performance is at 3dB gain compression referenced to peak gain.
2. See page 12 for load-pull and source-pull reference planes. $50\text{-}\Omega$ load-pull TRL fixtures are built with 20-mil RO4350B material.
3. NaN means the impedances are either undefined or varying in load-pull system.

3.1GHz, Load-pull

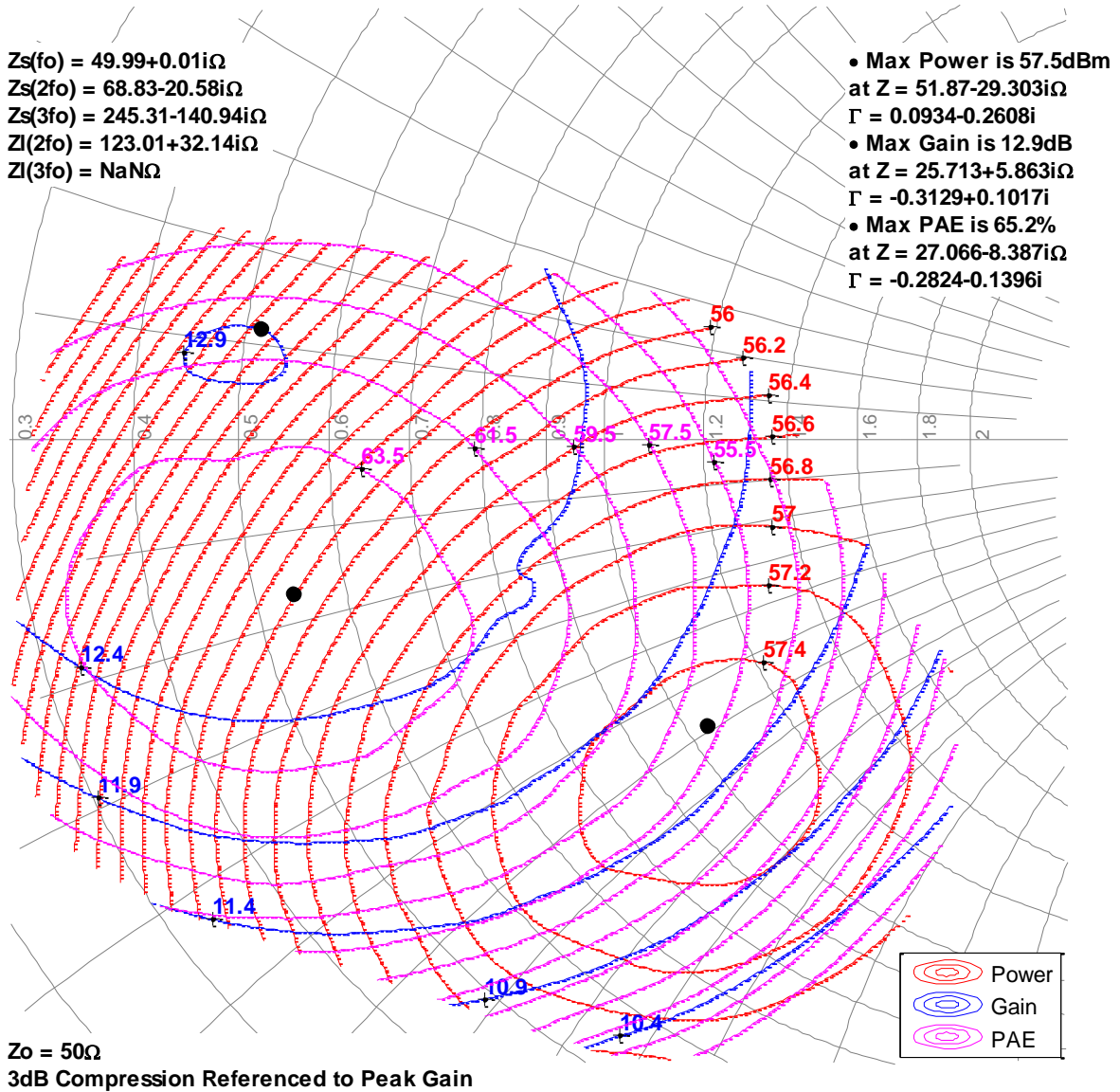

Typical Performance – Load-Pull Drive-up^{1, 2}

Notes:

1. 100 μ S PW, 10% DC pulsed signal, $V_D = 50$ V, $I_{DQ} = 750$ mA, $T_A = 25^\circ\text{C}$.
2. See page 12 for load-pull and source-pull reference planes where the performance was measured.

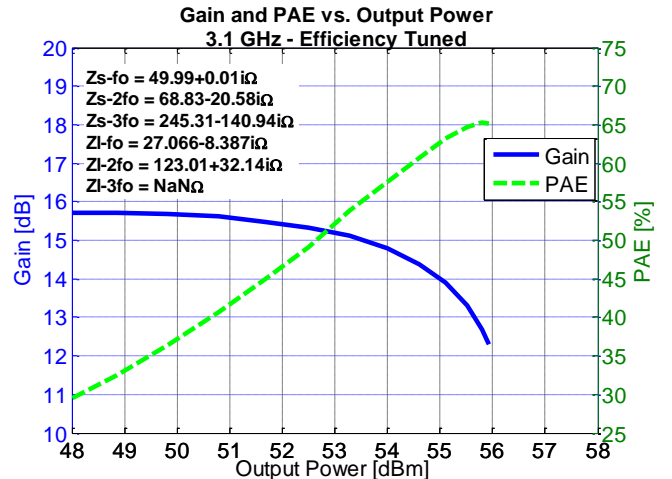
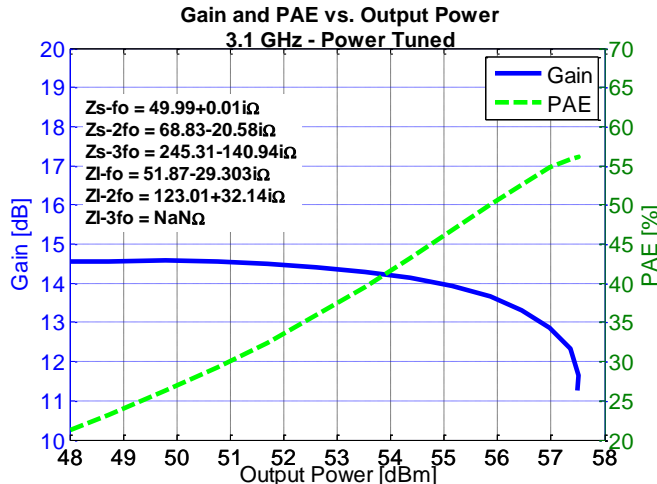
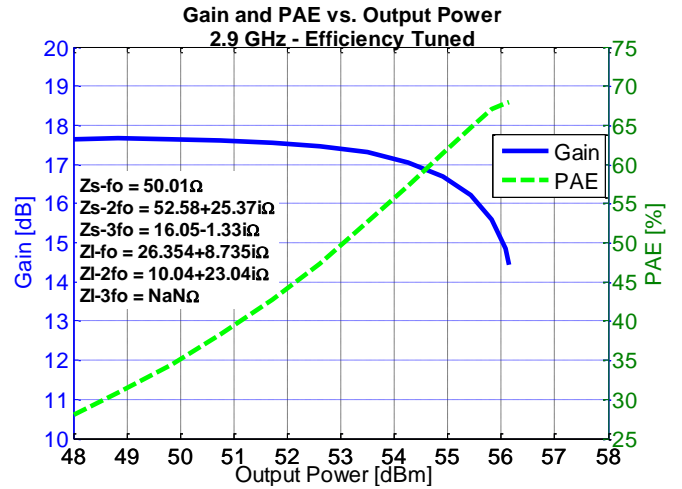
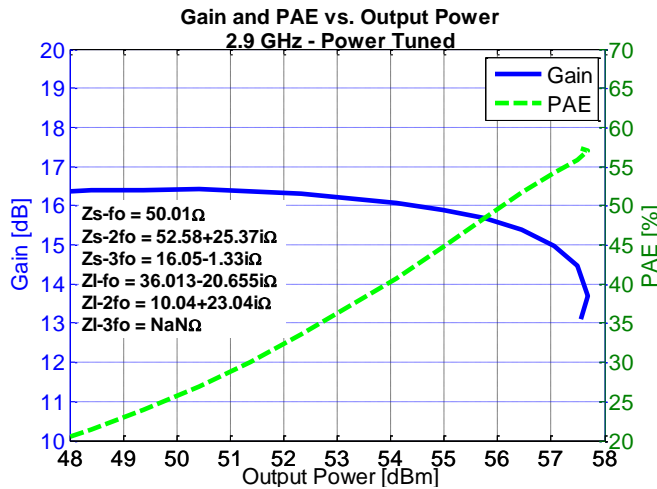
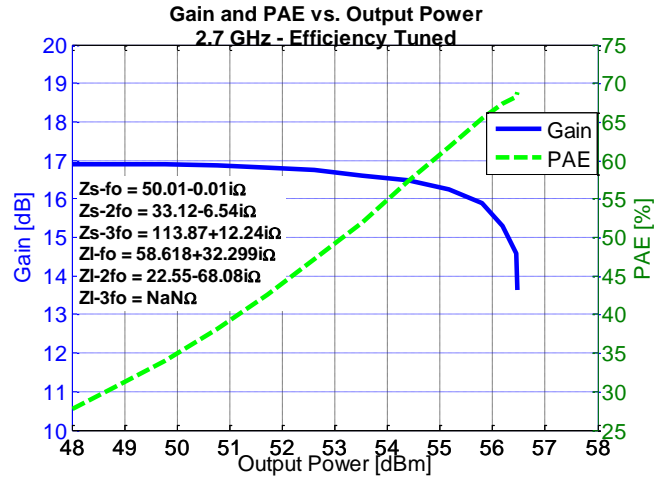
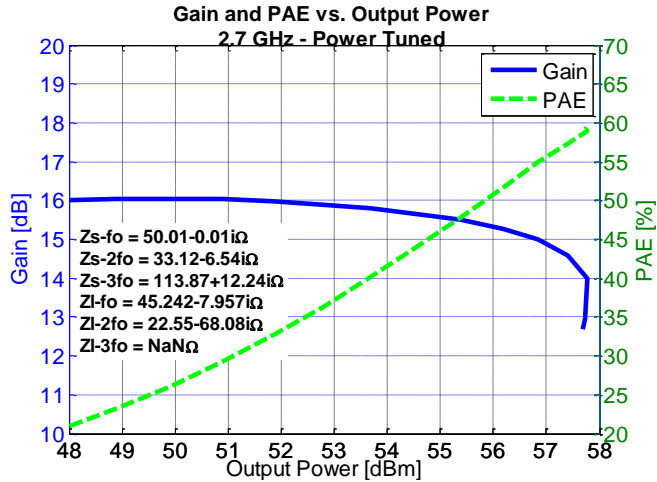

Power Drive-up Performance Over Temperatures Of 2.7 – 3.1 GHz EVB^{1, 2}

Notes:

1. $V_D = 50\text{ V}$, $I_{DQ} = 750\text{ mA}$, $100\text{ }\mu\text{S PW}$, $10\%\text{ DC}$.
2. Performance shown is at EVB connectors reference plane.

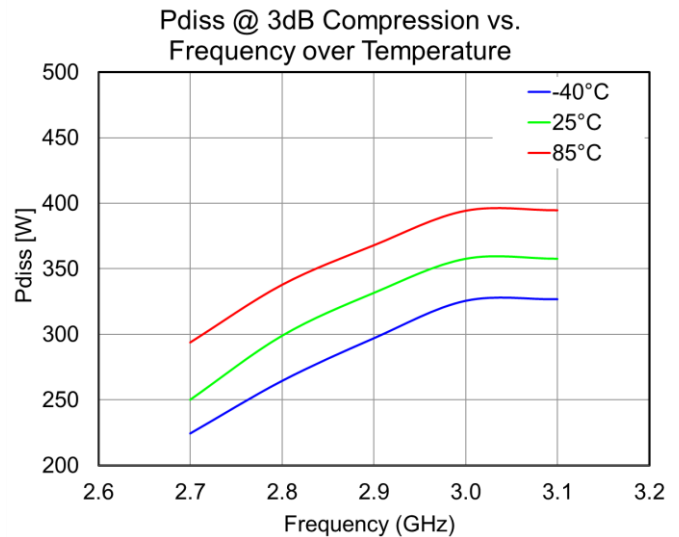
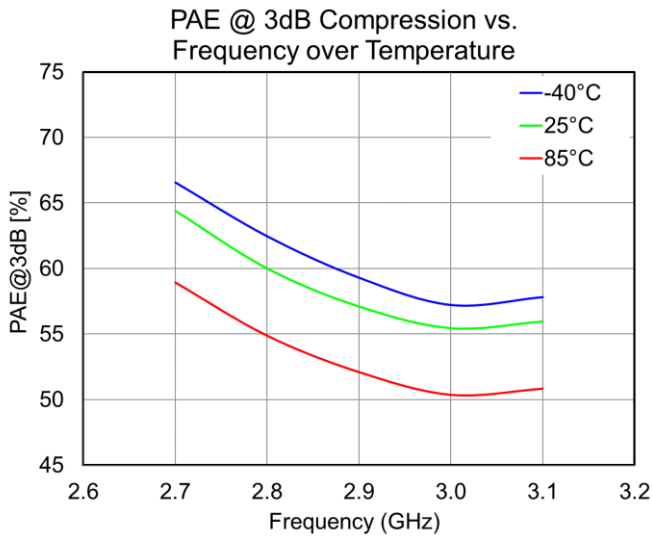
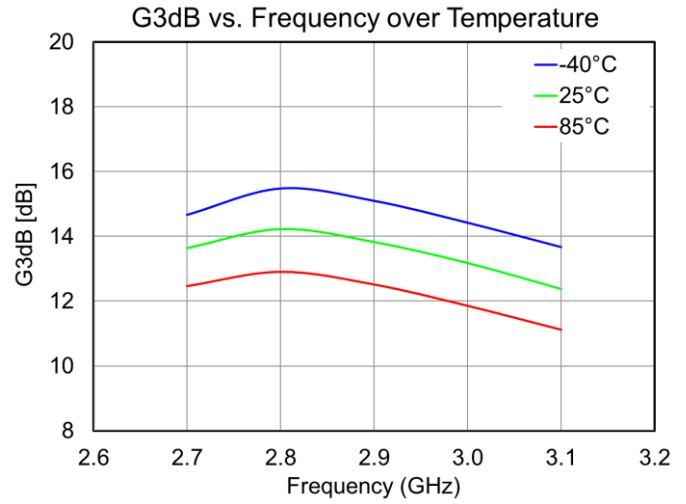
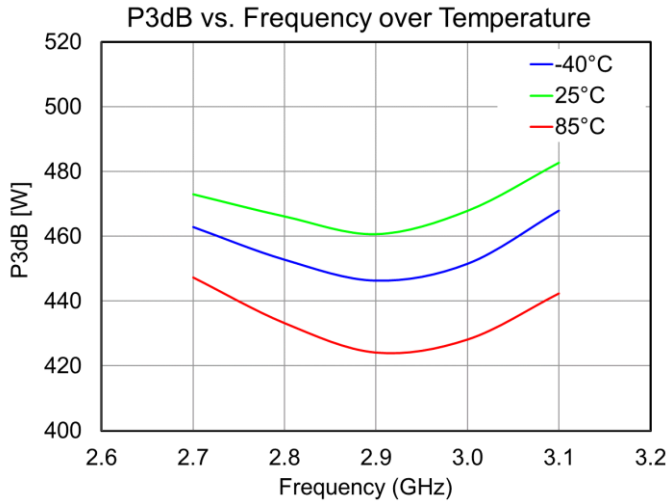

Power Drive-up Performance At 25°C Of 2.7 – 3.1 GHz EVB^{1,2}

Notes:

1. $V_D = 50\text{ V}$, $I_{DQ} = 750\text{ mA}$, $100\text{ }\mu\text{S PW}$, $10\%\text{ DC}$, $T_A = 25^\circ\text{C}$.
2. Performance shown is at EVB connectors reference plane.

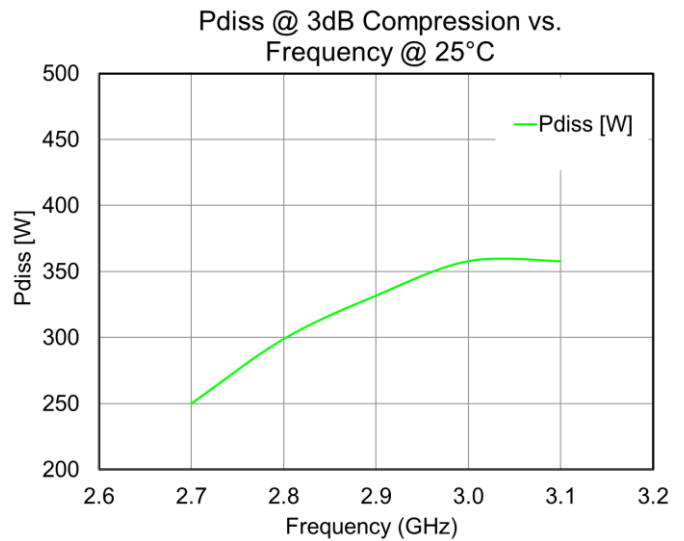
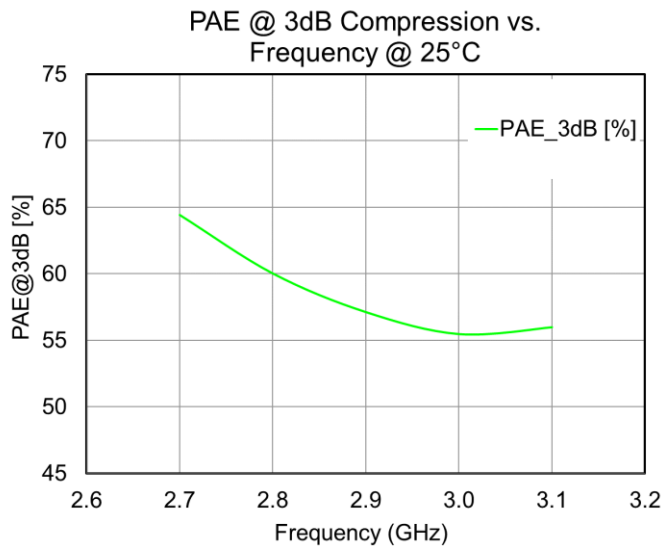
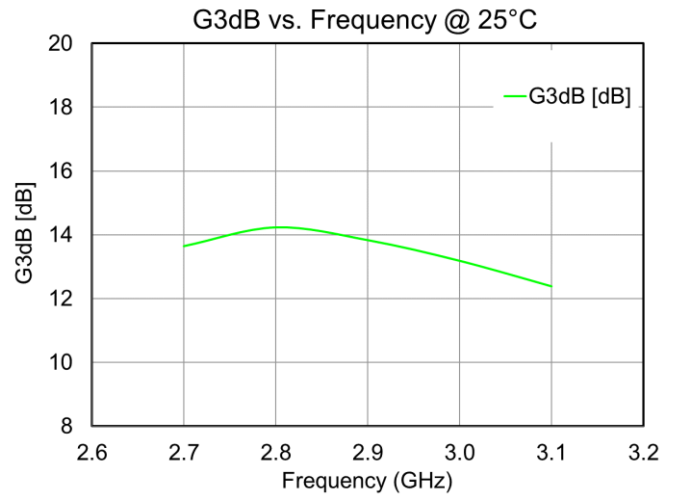
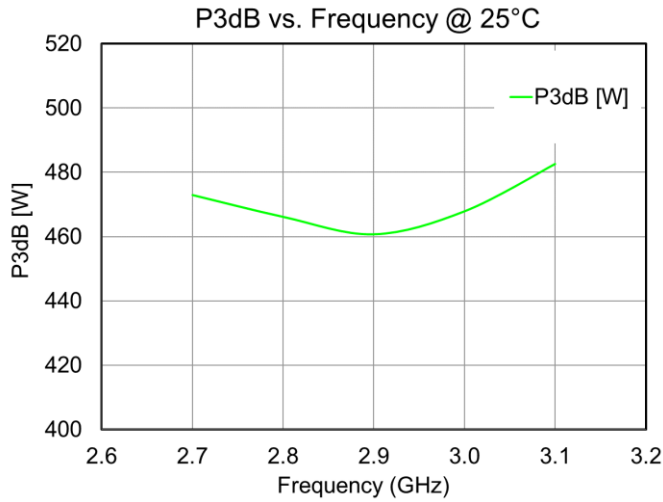

Pin Configuration, Marking and Description¹

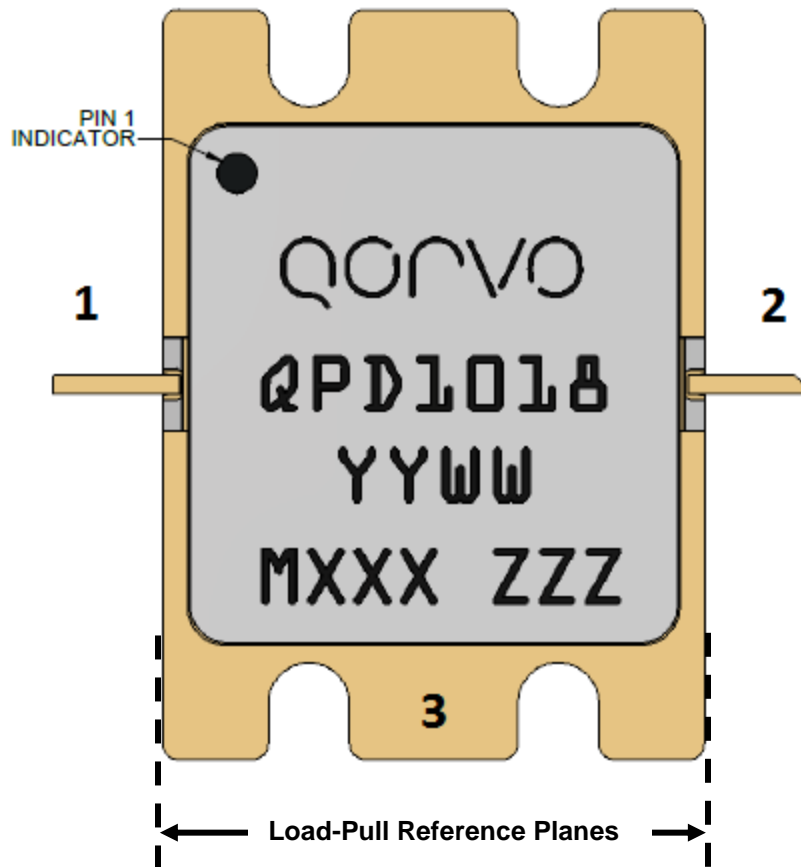

Pin Description

Pin	Symbol	Description
1	V_G / RF IN	Gate voltage / RF Input
2	V_D / RF OUT	Drain voltage / RF Output
3	GND	Package base / Ground

Notes:

- The QPD1018 will be marked with the “QPD1018” designator and a lot code marked below the part designator. The “YY” represents the last two digits of the calendar year the part was manufactured, the “WW” is the work week of the assembly lot start, the “MXXX” is the production lot number.

Package Dimensions^{1, 2, 3, 4}

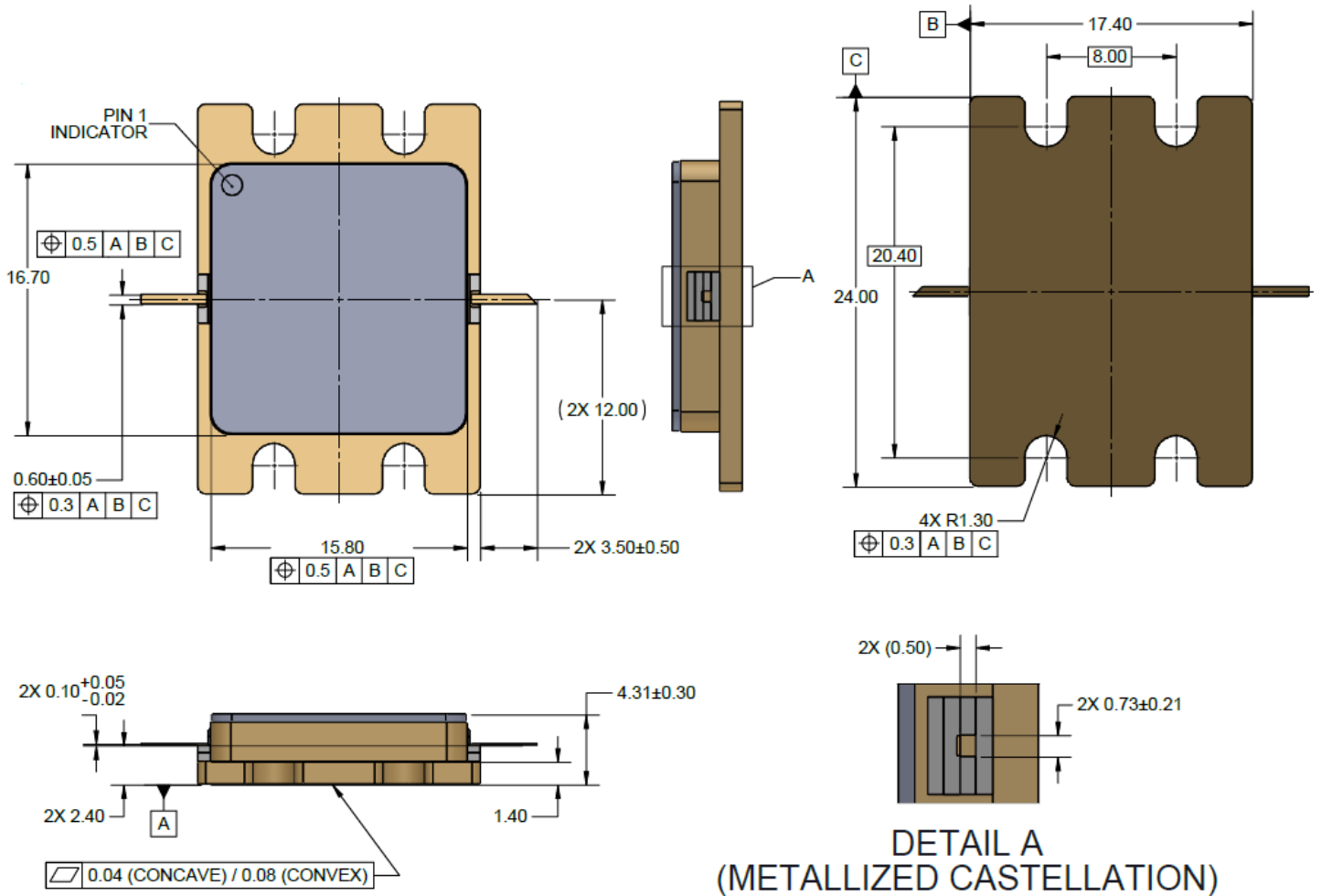

Notes:

1. All dimensions are in mm. otherwise noted, the tolerance is ± 0.15 mm.
2. Package is an all metal design with ceramic lid and feed thru's.
3. Package is epoxy sealed.
4. For instruction to mount the part, please refer to application note "[RF565 Package Mounting, Mechanical Mounting and PCB Considerations](#)".

Bias-up Procedure	Bias-down Procedure
1. Set V_G to -6 V.	1. Turn off RF signal.
2. Set I_D current limit to 1000 mA.	2. Turn off V_D
3. Apply 50 V V_D .	3. Wait 2 seconds to allow drain capacitor to discharge
4. Slowly adjust V_G until I_D is set to 750 mA.	4. Turn off V_G
5. Set I_D current limit to 2 A	
6. Apply RF.	

PCB Assembly – 2.7 – 3.1 GHz EVB¹

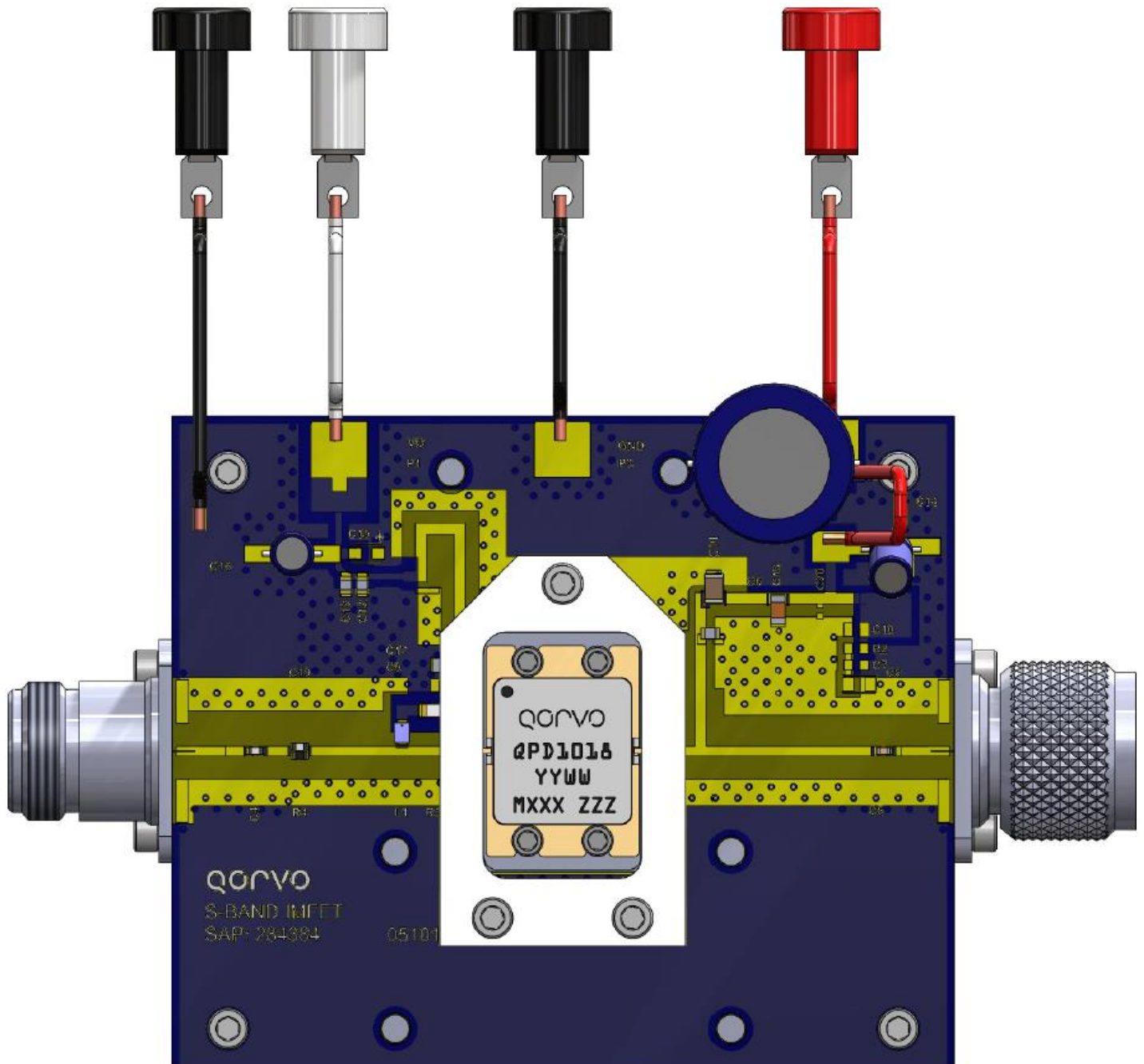

Notes:

1. PCB Material: RO4350B, 20 mil thickness, 1 oz copper cladding

Bill of Material – 2.7 – 3.1 GHz EVB

Ref Des	Value	Qty	Manufacturer	Part Number
C1	680 uF	1	Panasonic	EEU-FC2A681
C4, C19	10 pF	2	ATC	ATC600S100JW250XT
C5	15 pF	1	ATC	ATC600S150FT250XT
C6, C9	10 pF	2	ATC	ATC600F100BT250XT
C12	10000 pF	1	AVX/Kyocera	08051C103KAZ2A
C11	0.1 uF	1	Murata	GRM32NR72A104KA01L
C13	0.1 uF	1	Kemet	C0805C104K5RACTU
C14, C16	10 uF	2	Panasonic	ECA-2AM100
C17, C18	10000 pF	2	Samsung	CL31B103KGFNNNE
R3	10 Ohm	1	Panasonic	ERJ-8GEYJ100V
R4	1 kOhm	1	Vishay	CRCW06031K00FKTA
L1	22 nH	1	Coilcraft	0805HT-22NTJLB

Recommended Solder Temperature Profile

