

### General Description

The Qorvo QPD1022 is a 10 W ( $P_{3dB}$ ) discrete GaN on SiC HEMT which operates from DC to 12 GHz. This wideband device is a single stage unmatched power amplifier transistor in an over-molded plastic package. The wide bandwidth of the QPD1022 makes it suitable for many different applications from DC to 12 GHz.

The device is housed in an industry-standard 3 x 3 mm surface mount QFN package.

Lead-free and ROHS compliant

Evaluation boards are available upon request.

### Functional Block Diagram

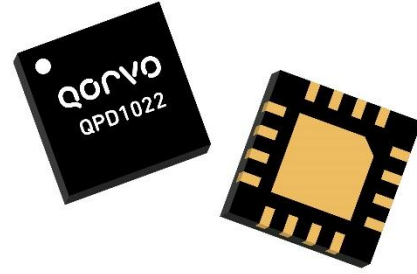
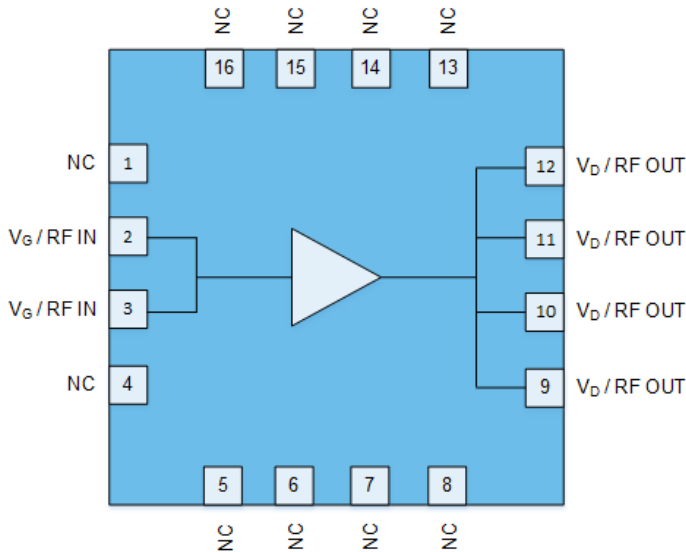

16 Pin QFN (3 x 3 x 0.85 mm)

### Product Features<sup>1</sup>

- Frequency: DC to 12 GHz
- Output Power ( $P_{3dB}$ ): 11 W<sup>1</sup>
- Linear Gain: 24.0 dB<sup>1</sup>
- Typical PAE<sub>3dB</sub>: 68.8 %<sup>1</sup>
- Operating Voltage: 32 V
- Low thermal resistance package
- CW and Pulse capable
- 3 x 3 mm package

Note 1: @ 2 GHz (Loadpull)

### Applications

- Military radar
- Civilian radar
- Land mobile and military radio communications
- Test instrumentation
- Wideband or narrowband amplifiers
- Jammers

### Ordering Information

Part No.	Description
QPD1022S2	2 Piece Sample Bag
QPD1022SQ	25 Piece Sample Bag
QPD1022SR	100 Piece 7" Reel
QPD1022EVB01	3.1 – 3.5 GHz EVB

### Absolute Maximum Ratings<sup>1,2</sup>

Parameter	Rating	Units
Breakdown Voltage, $BV_{DG}$	100	V
Gate Voltage Range, $V_G$	-7 – +2	V
Drain Current, $I_D$	2.4	A
Gate Current Range, $I_G^1$	0.9	mA
Power Dissipation, CW, $P_{DISS}$	17.5	W
RF Input Power at 3.3 GHz, CW, 50 $\Omega$ , T = 25 °C	+29	dBm
Mounting Temperature (30 Seconds)	320	°C
Storage Temperature	-65 to +150	°C

Notes:

1. At Channel temperature of 160°C.
2. Operation of this device outside the parameter ranges given above may cause permanent damage.

### Recommended Operating Conditions<sup>1, 2, 3, 4</sup>

Parameter	Min	Typ	Max	Units
Operating Temp. Range	-40	+25	+85	°C
Drain Voltage Range, $V_D$	+12	+32	+40	V
Drain Bias Current, $I_{DQ}$	–	50	–	mA
Drain Current, $I_D$	–	610	–	mA
Gate Voltage, $V_G^4$	–	-2.8	–	V
Power Dissipation, CW ( $P_D$ ) <sup>2</sup>	–	–	13.8	W
Power Dissipation, Pulsed ( $P_D$ ) <sup>2, 3</sup>	–	–	18.0	W

Notes:

1. Electrical performance is measured under conditions noted in the electrical specifications table. Specifications are not guaranteed over all recommended operating conditions.
2. Back plane of package at 85 °C
3. Pulse Width = 100  $\mu$ s, Duty Cycle = 20%
4. To be adjusted to desired  $I_{DQ}$

**Pulsed Characterization – Load Pull Performance – Power Tuned<sup>1</sup>**

Parameters	Typical Values						Unit
	2	3	4	6	9	10	
Frequency, F	2	3	4	6	9	10	GHz
Linear Gain, $G_{LIN}$	24.0	21.9	19.7	16.1	12.2	10.7	dB
Output Power at 3dB compression point, $P_{3dB}$	40.4	40.0	40.3	40.4	40.0	39.9	dBm
Power-Added-Efficiency at 3dB compression point, $PAE_{3dB}$	58.0	52.8	57.0	54.5	45.0	40.0	%
Gain at 3dB compression point	21.0	18.9	16.7	13.1	9.2	7.7	dB

Notes:

1. Test conditions unless otherwise noted:  $V_D = 32\text{ V}$ ,  $I_{DQ} = 50\text{ mA}$ , Temp = +25 °C

**Pulsed Characterization – Load Pull Performance – Efficiency Tuned<sup>1</sup>**

Parameters	Typical Values						Unit
	2	3	4	6	9	10	
Frequency	2	3	4	6	9	10	GHz
Linear Gain, $G_{LIN}$	25.6	23.4	21.3	16.9	12.9	11.9	dB
Output Power at 3dB compression point, $P_{3dB}$	36.8	39.0	38.3	39.4	39.4	38.7	dBm
Power-Added-Efficiency at 3dB compression point, $PAE_{3dB}$	68.8	66.	69.4	61.2	50.3	46.3	%
Gain at 3dB compression point, $G_{3dB}$	22.6	20.4	18.3	13.9	9.9	8.9	dB

Notes:

- 1- Test conditions unless otherwise noted:  $V_D = 32\text{ V}$ ,  $I_{DQ} = 50\text{ mA}$ , Temp = +25 °C

**RF Characterization – 3.1 – 3.5 GHz EVB Performance At 3.3 GHz<sup>1</sup>**

Parameter	Min	Typ	Max	Units
Linear Gain, $G_{LIN}$	–	16.3	–	dB
Output Power at 3dB compression point, $P_{3dB}$	–	39.9	–	dBm
Drain Efficiency at 3dB compression point, $DEFF_{3dB}$	–	58.7	–	%
Gain at 3dB compression point, $G_{3dB}$	–	13.3	–	dB

Notes:

1.  $V_D = 32\text{ V}$ ,  $I_{DQ} = 50\text{ mA}$ , Temp = +25 °C, Pulse Width = 100 us, Duty Cycle = 20%

**RF Characterization – Mismatch Ruggedness at 3.3 GHz<sup>1,2</sup>**

Symbol	Parameter	dB Compression	Typical
VSWR	Impedance Mismatch Ruggedness	3	10:1

Notes:

1. Test conditions unless otherwise noted:  $T_A = 25\text{ °C}$ ,  $V_D = 32\text{ V}$ ,  $I_{DQ} = 50\text{ mA}$
2. Driving input power is determined at pulsed compression under matched condition at EVB output connector.

**Thermal and Reliability Information – CW<sup>1</sup>**

**Peak IR Surface Temperature vs. Dissipated Power**  
 Surface of QFN Base Fixed @ 85°C

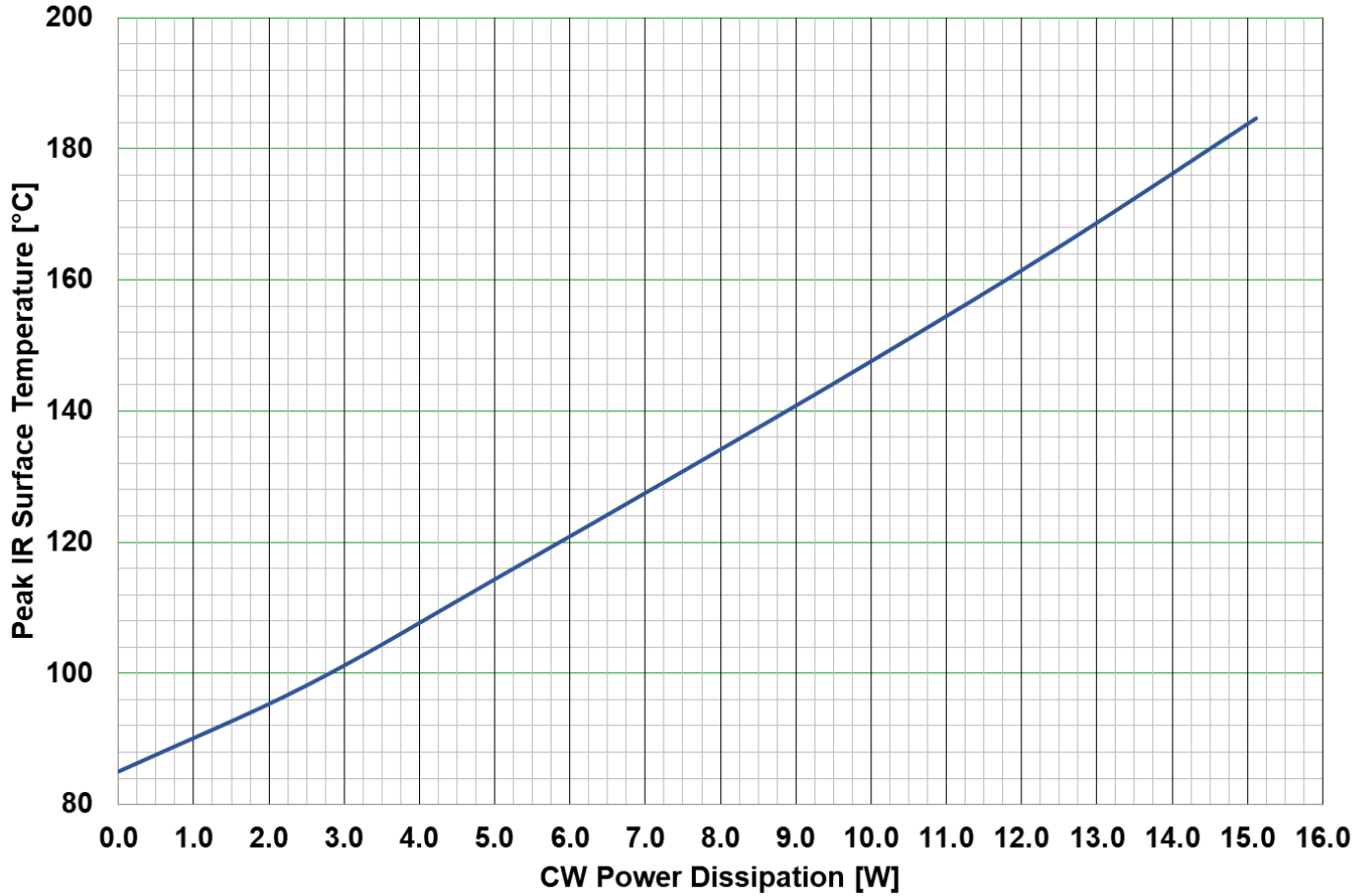

Parameter	Conditions	Values	Units
Thermal Resistance, IR <sup>1</sup> ( $\theta_{JC}$ )	85 °C back side temperature	6.2	°C/W
Peak IR Surface Temperature <sup>1</sup> ( $T_{CH}$ )	7.6 W P <sub>diss</sub> , CW	132	°C

Notes:

1- Refer to the following document: [GaN Device Channel Temperature, Thermal Resistance, and Reliability Estimates](#)

**Thermal and Reliability Information – Pulsed<sup>1</sup>**

**Peak IR Surface Temperature vs. Dissipated Power**  
 Surface of QFN Base Fixed @ 85°C

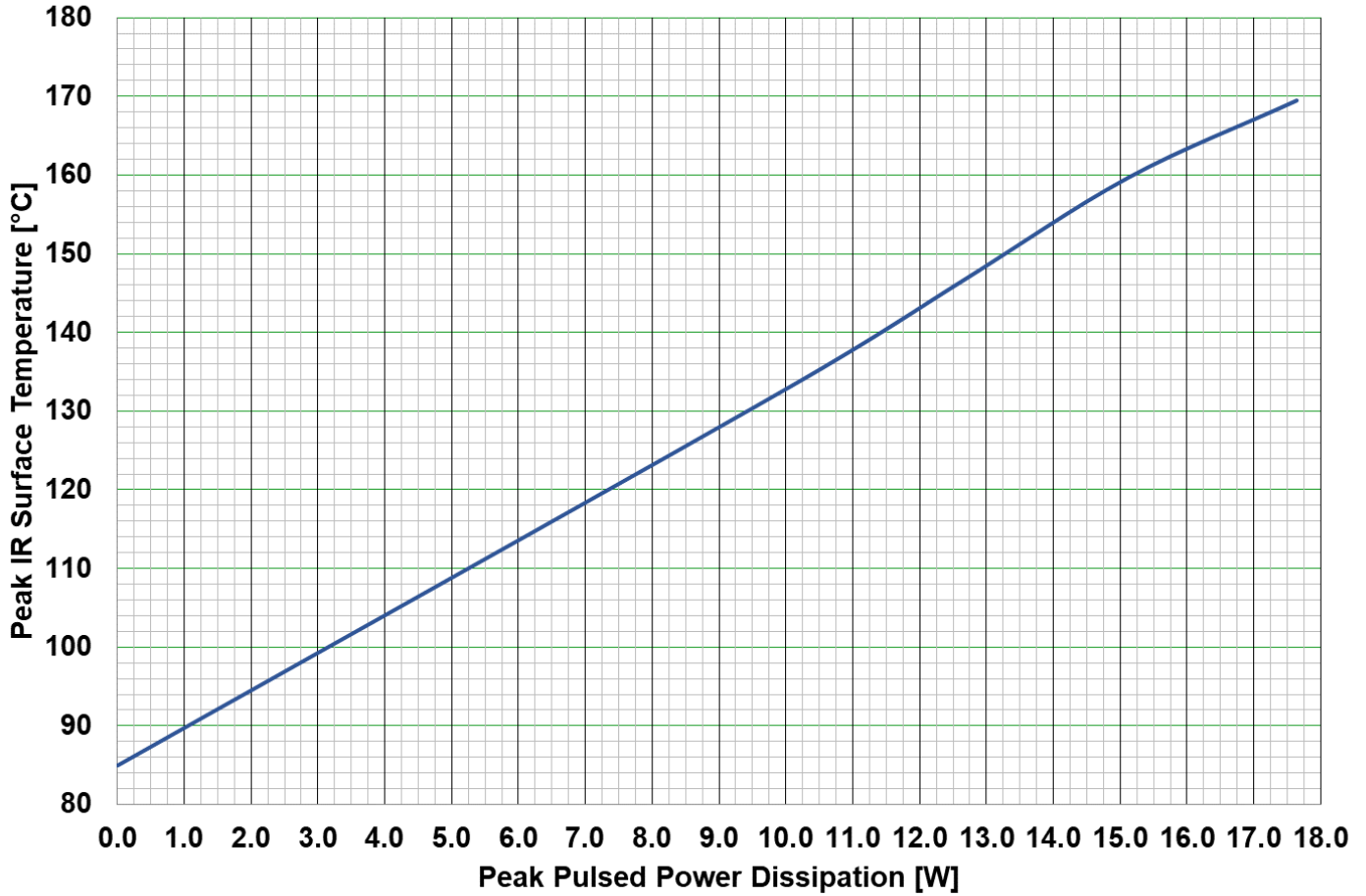

Parameter	Conditions	Values	Units
Thermal Resistance, IR <sup>1</sup> ( $\theta_{JC}$ )	85 °C back side temperature	4.7	°C/W
Peak IR Surface Temperature <sup>1</sup> ( $T_{CH}$ )	7.6 W P <sub>diss</sub> , 100us PW, 20% Duty cycle	121	°C

Notes:

- 1- Refer to the following document: [GaN Device Channel Temperature, Thermal Resistance, and Reliability Estimates](#)

**Load Pull Smith Charts<sup>1,2</sup>**

Notes:

1.  $V_d = 32\text{ V}$ ,  $I_{DQ} = 50\text{ mA}$ , Pulsed signal with 100 us pulse width and 20 % duty cycle.
2. See page 17 for load pull and source pull reference planes.

**2 GHz, Load-pull**

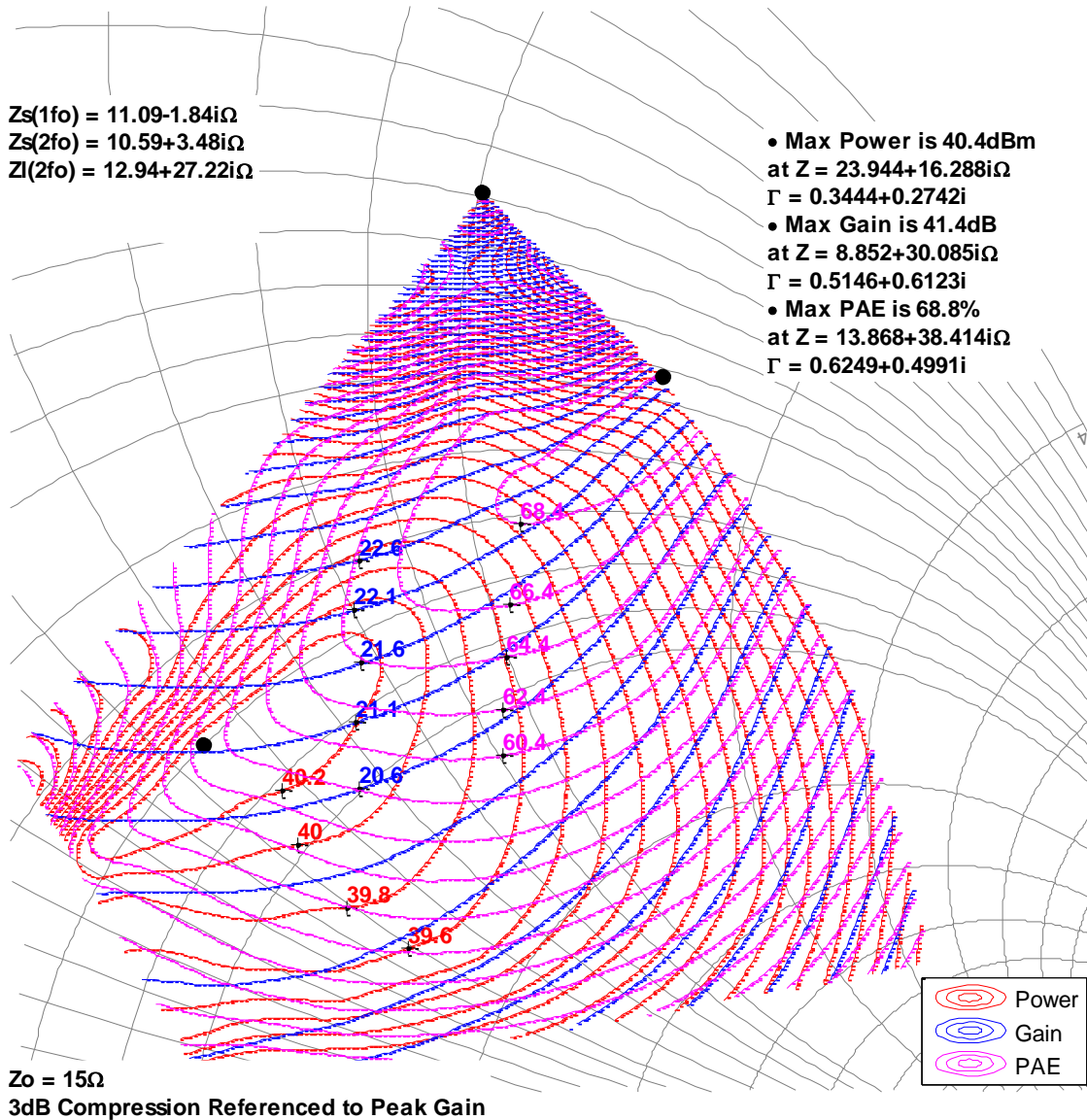

**Load Pull Smith Charts<sup>1,2</sup>**

Notes:

1.  $V_d = 32\text{ V}$ ,  $I_{DQ} = 50\text{ mA}$ , Pulsed signal with 100 us pulse width and 20 % duty cycle.
2. See page 17 for load pull and source pull reference planes.

**3 GHz, Load-pull**

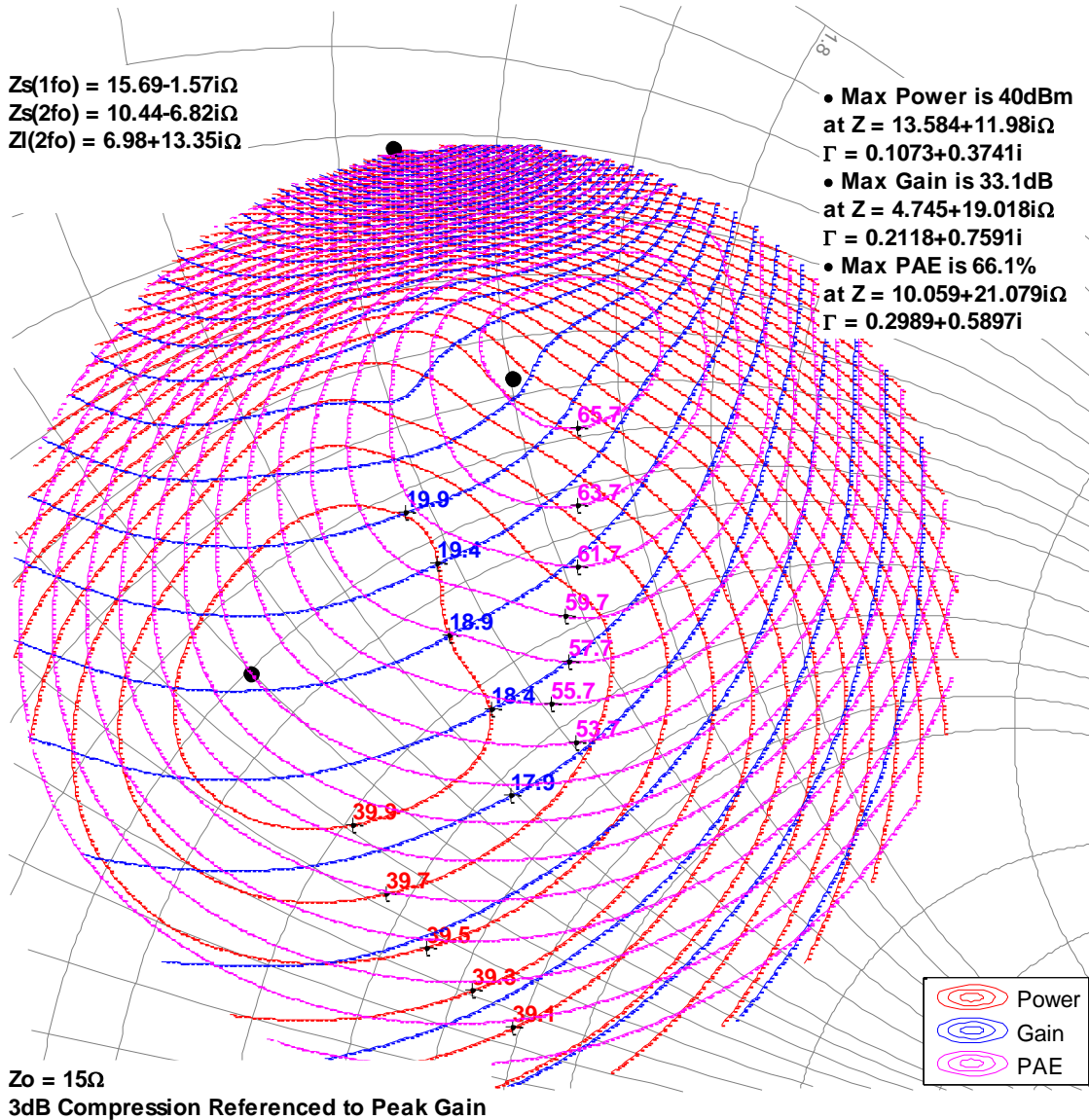

Load Pull Smith Charts<sup>1,2</sup>

Notes:

1.  $V_d = 32\text{ V}$ ,  $I_{DQ} = 50\text{ mA}$ , Pulsed signal with 100 us pulse width and 20 % duty cycle.
2. See page 17 for load pull and source pull reference planes.

4 GHz, Load-pull

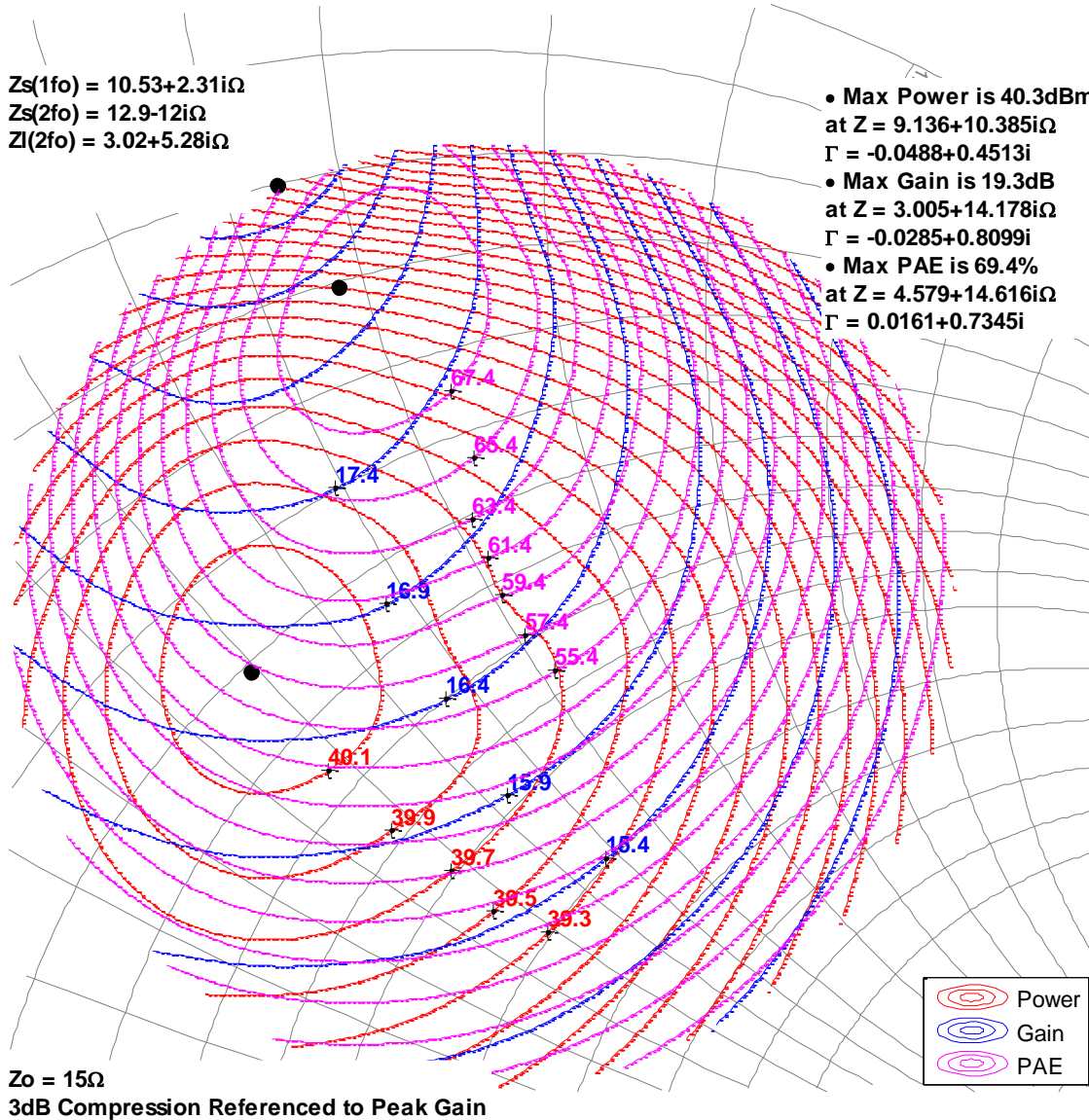



Load Pull Smith Charts<sup>1,2</sup>

Notes:

1.  $V_d = 32\text{ V}$ ,  $I_{DQ} = 50\text{ mA}$ , Pulsed signal with 100 us pulse width and 20 % duty cycle.
2. See page 17 for load pull and source pull reference planes.

6 GHz, Load-pull

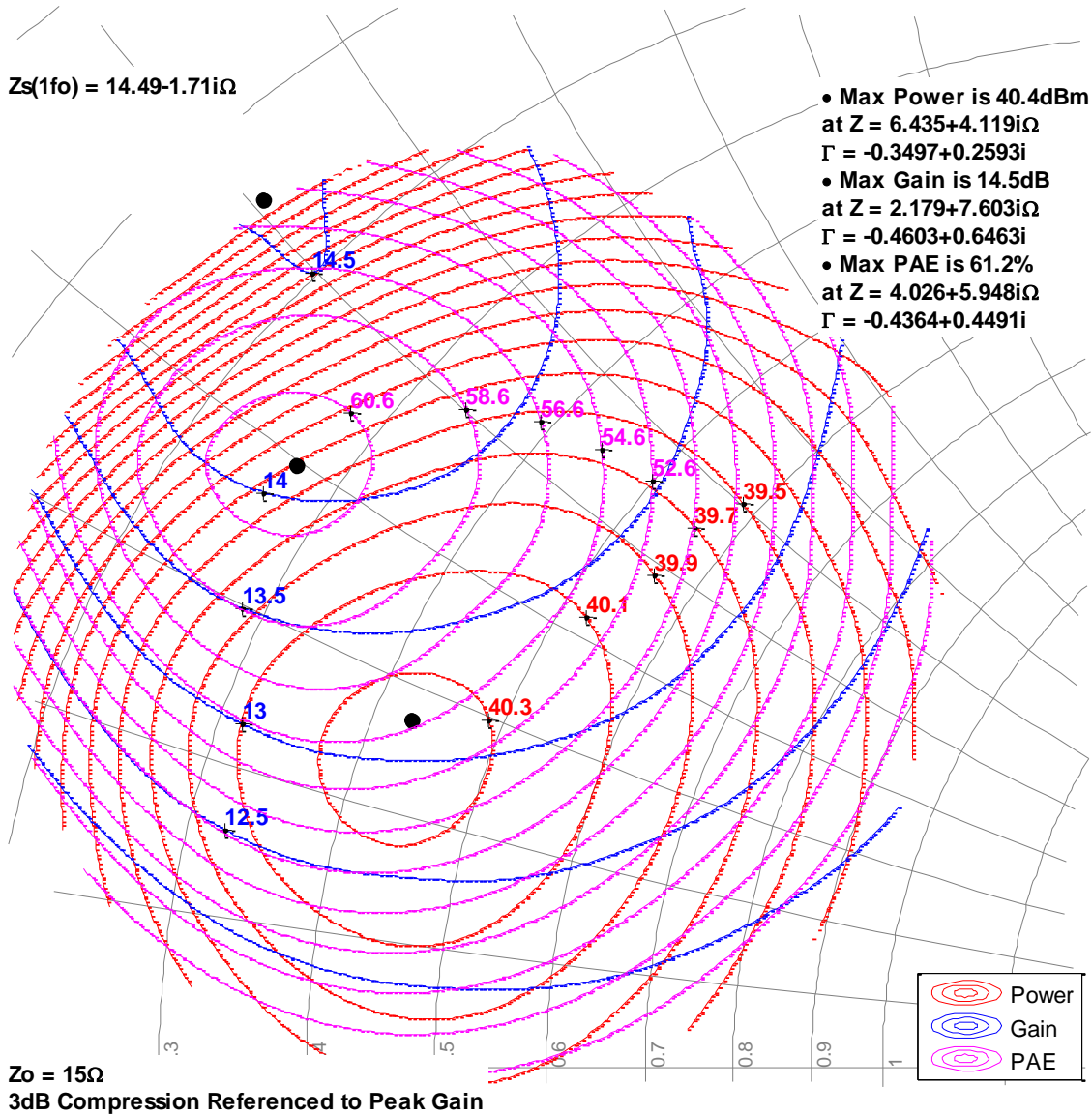

**Load Pull Smith Charts<sup>1,2</sup>**

Notes:

1.  $V_d = 32\text{ V}$ ,  $I_{DQ} = 50\text{ mA}$ , Pulsed signal with 100 us pulse width and 20 % duty cycle.
2. See page 17 for load pull and source pull reference planes.

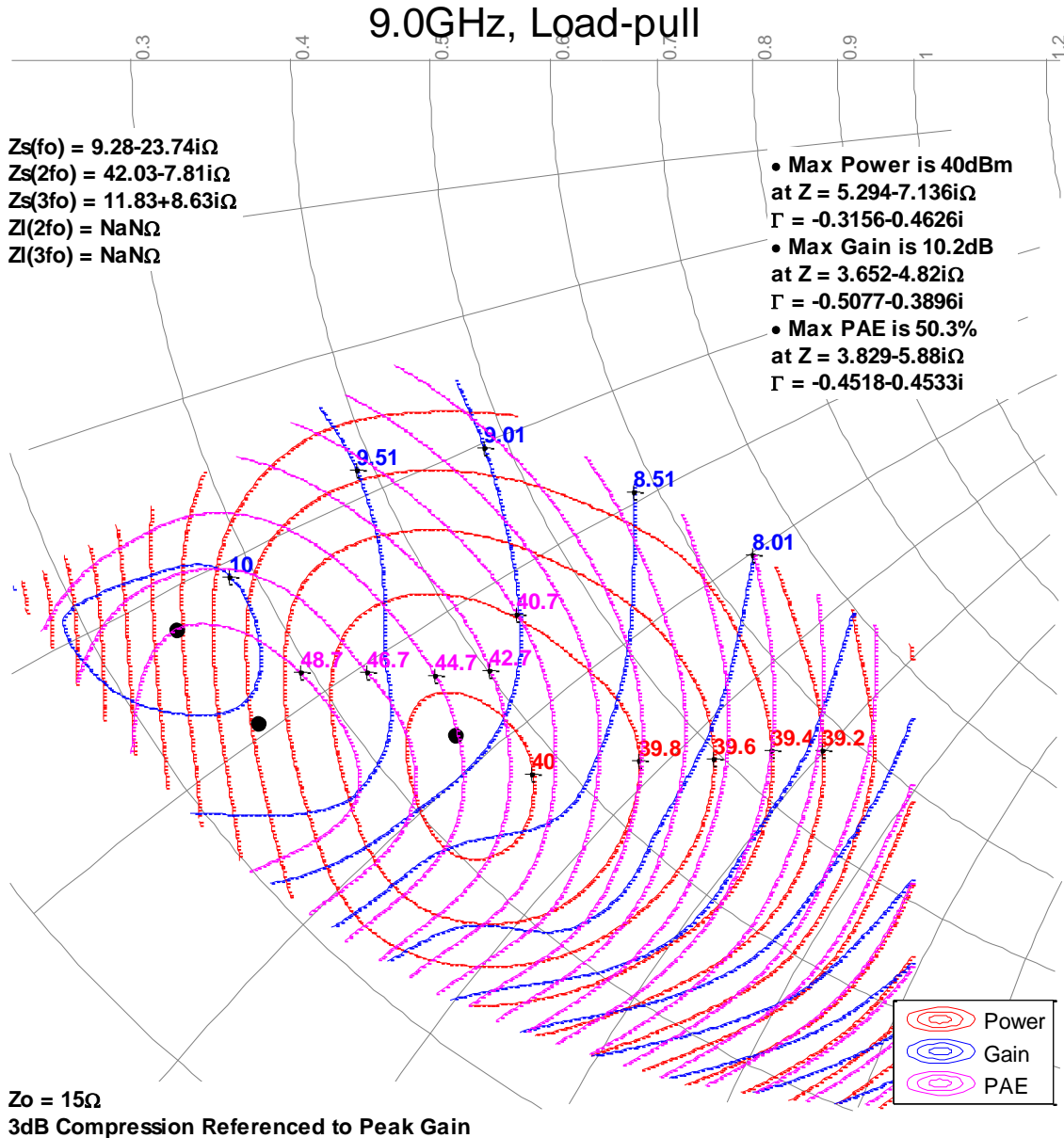

**Load Pull Smith Charts<sup>1,2</sup>**

Notes:

1.  $V_d = 32\text{ V}$ ,  $I_{DQ} = 50\text{ mA}$ , Pulsed signal with 100 us pulse width and 20 % duty cycle.
2. See page 17 for load pull and source pull reference planes.

**10.0GHz, Load-pull**

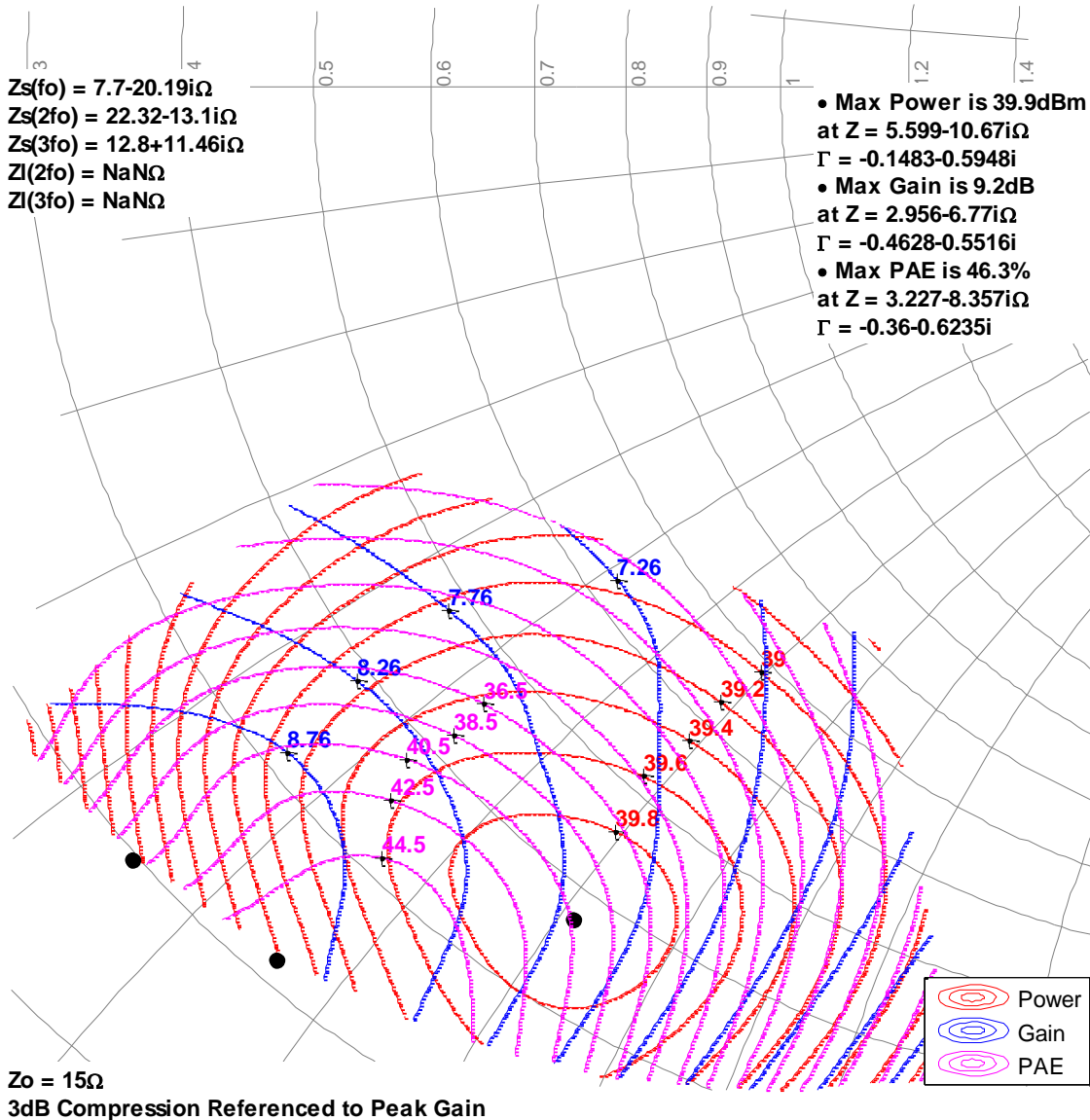

### Typical Performance – Load Pull Drive-up<sup>1, 2</sup>

Notes:

1. Pulsed signal with 100 us pulse width and 20 % duty cycle,  $V_d = 32\text{ V}$ ,  $I_{DQ} = 50\text{ mA}$
2. See page 17 for load pull and source pull reference planes where the performance was measured.

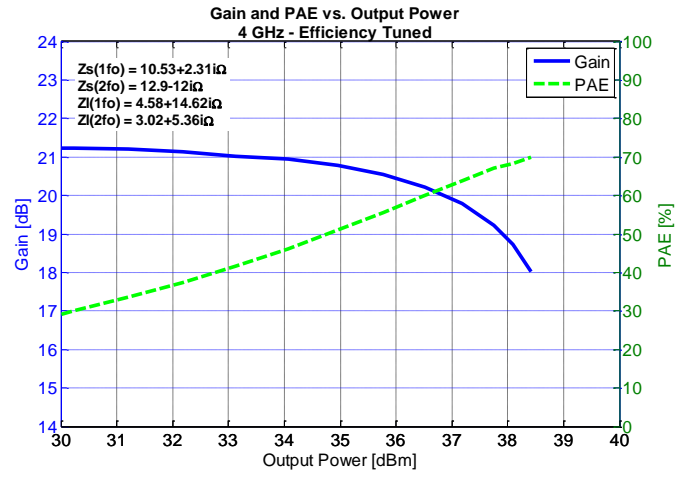
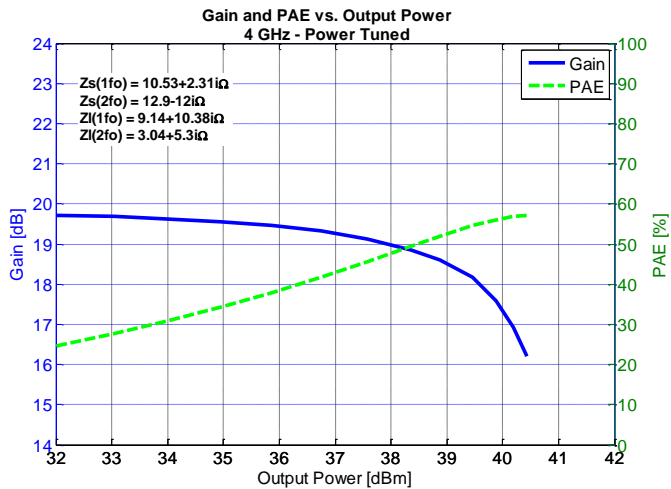
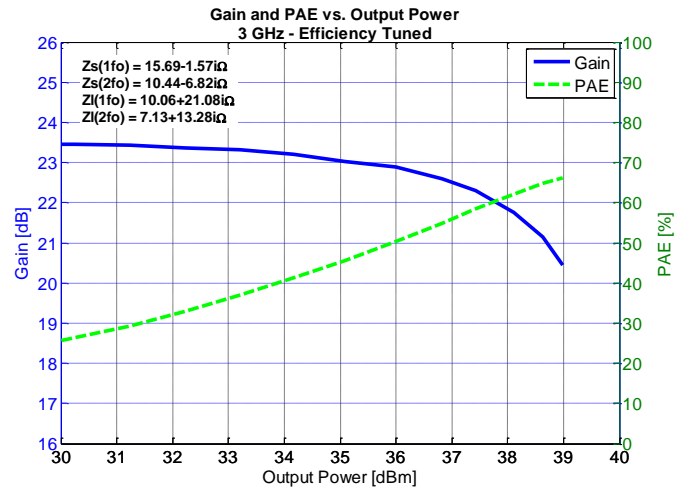
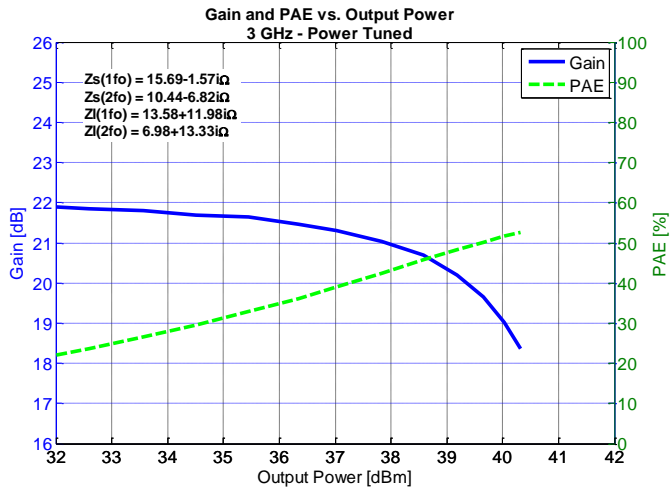
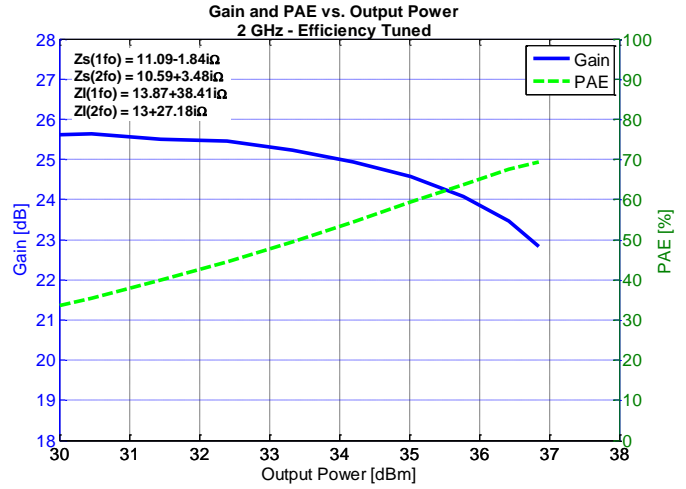
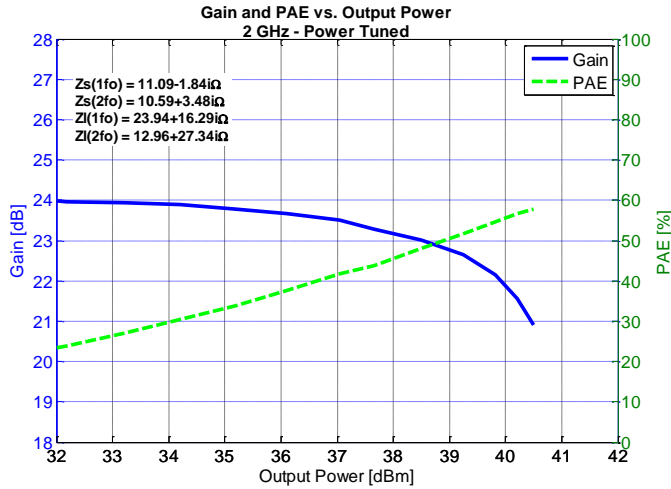

### Typical Performance – Load Pull Drive-up<sup>1, 2</sup>

Notes:

1. Pulsed signal with 100 us pulse width and 20 % duty cycle,  $V_d = 32\text{ V}$ ,  $I_{DQ} = 50\text{ mA}$
2. See page 17 for load pull and source pull reference planes where the performance was measured.

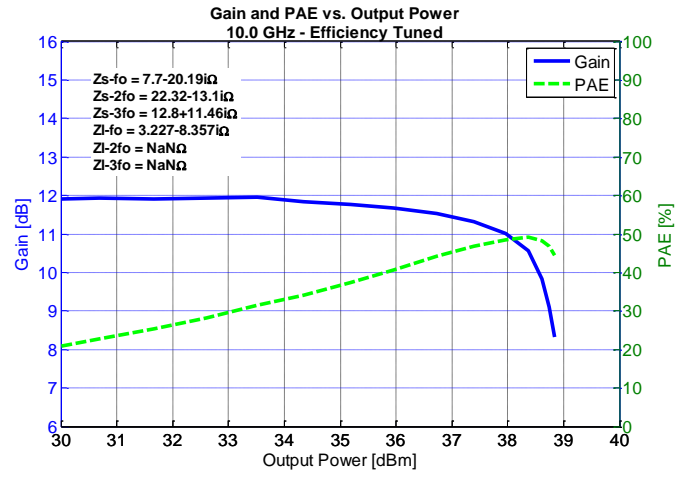
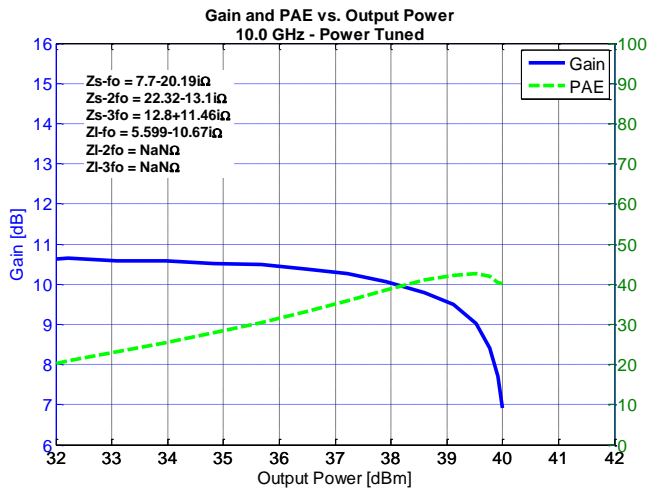
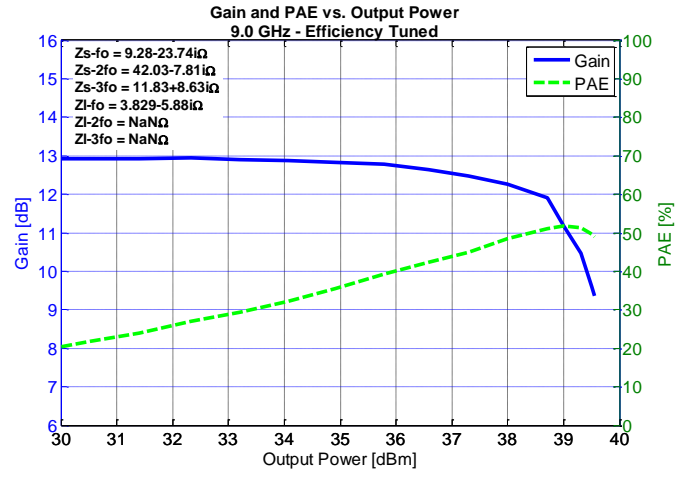
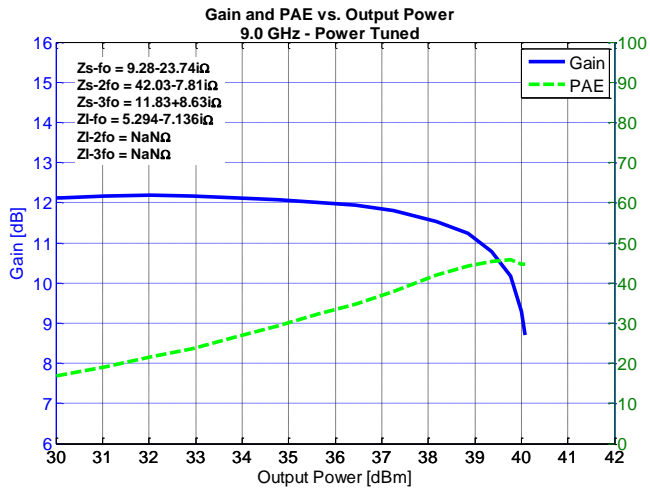
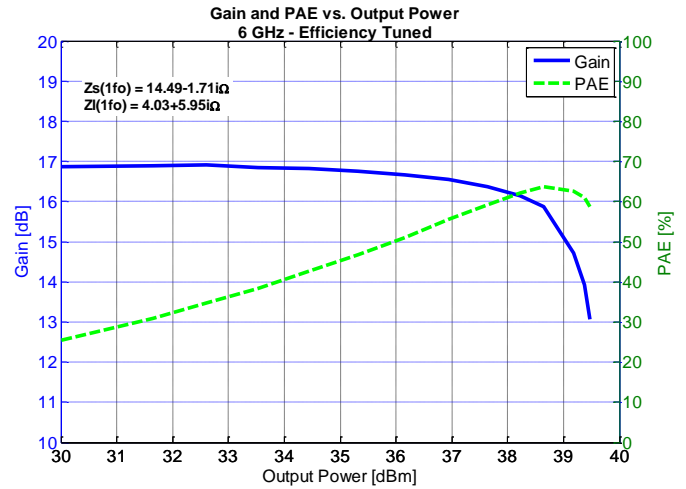
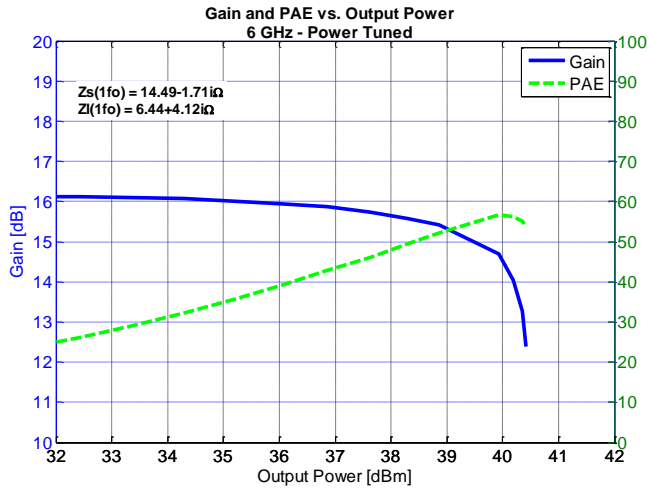

### Power Driveup Performance Over Temperatures of 3.1 – 3.5 GHz EVB<sup>1</sup>

Notes:

1-  $V_d = 32\text{ V}$ ,  $I_{bQ} = 50\text{ mA}$ , Pulse Width = 100 us, Duty Cycle = 20 %

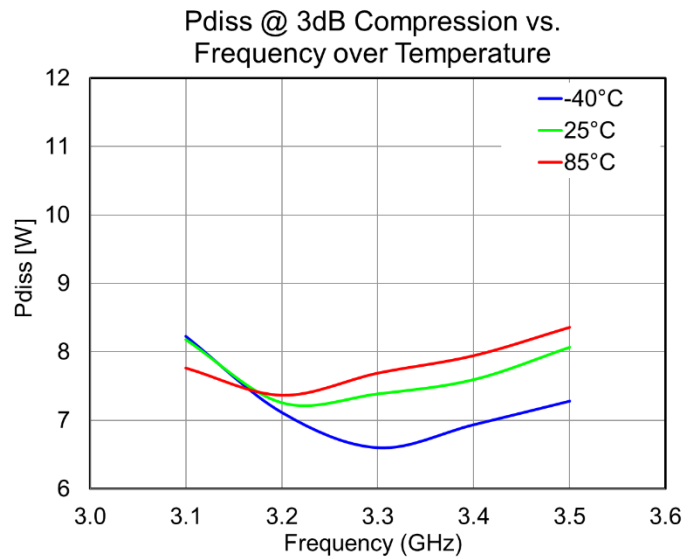
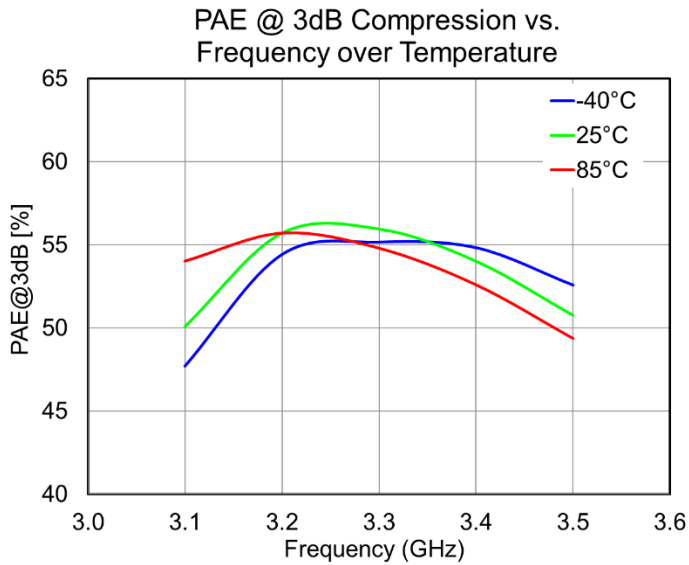
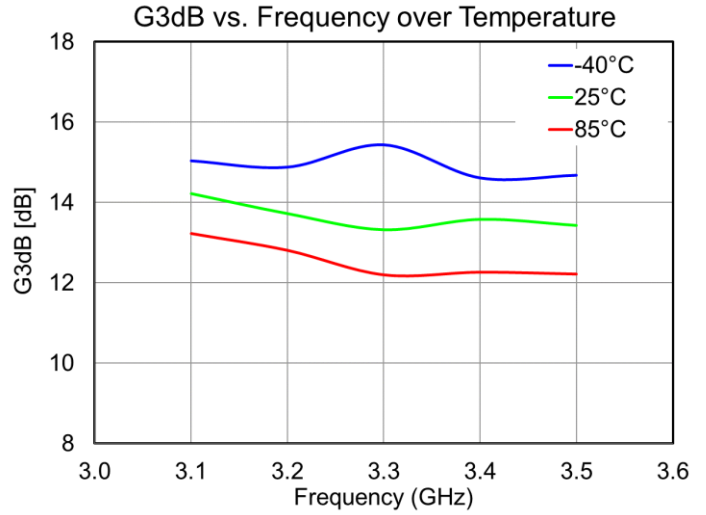
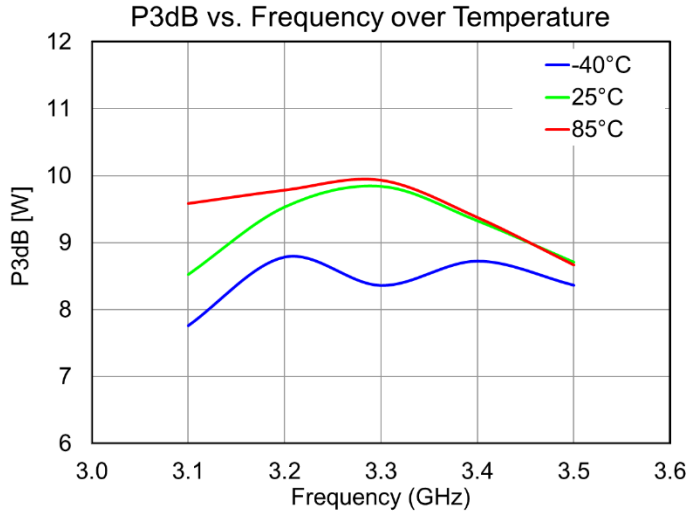

### Power Driveup Performance at 25 °C of 3.1 – 3.5 GHz EVB<sup>1</sup>

Notes:

1-  $V_d = 32\text{ V}$ ,  $I_{DQ} = 50\text{ mA}$ , Pulse Width = 100 us, Duty Cycle = 20 %

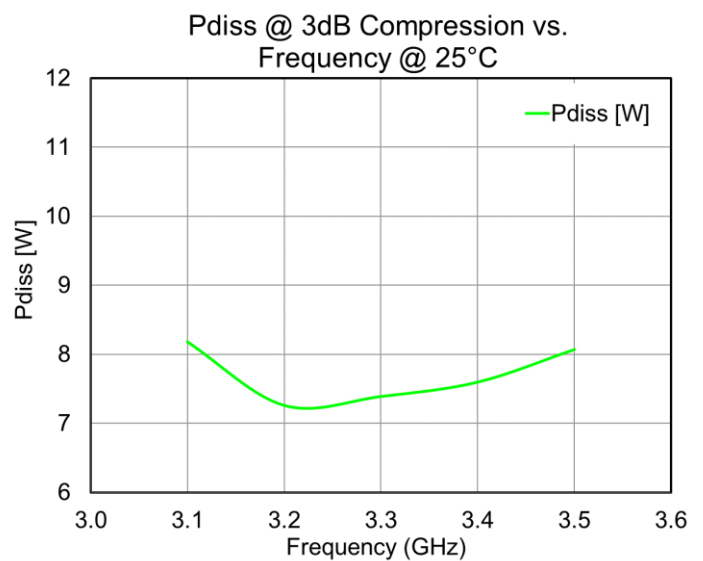
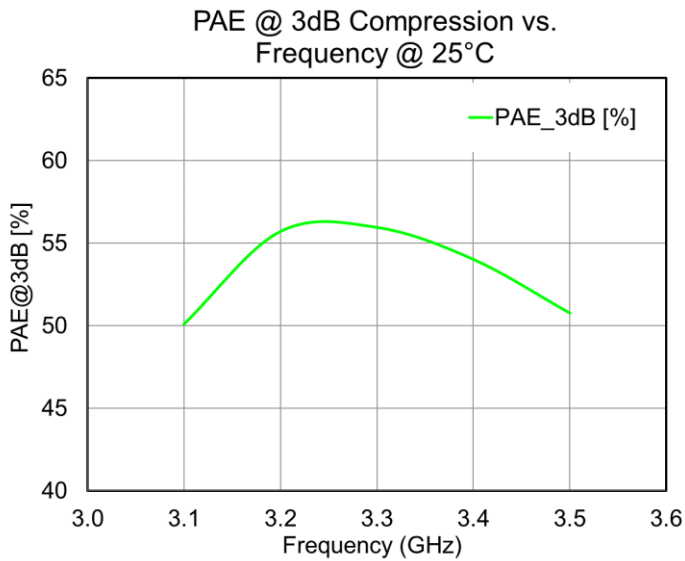
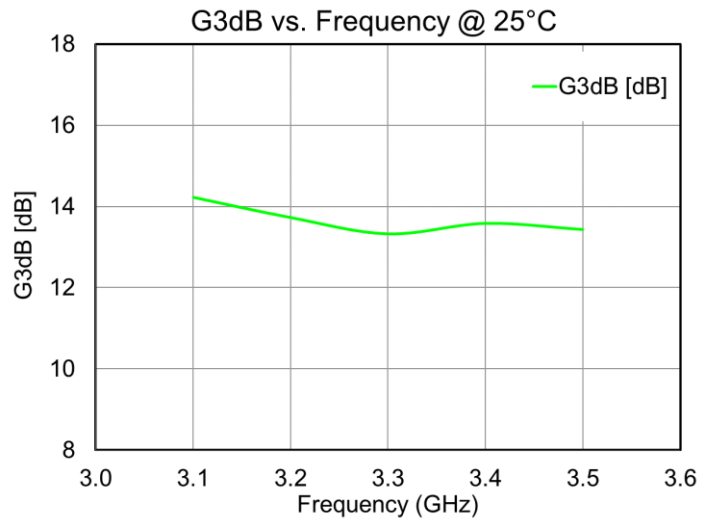
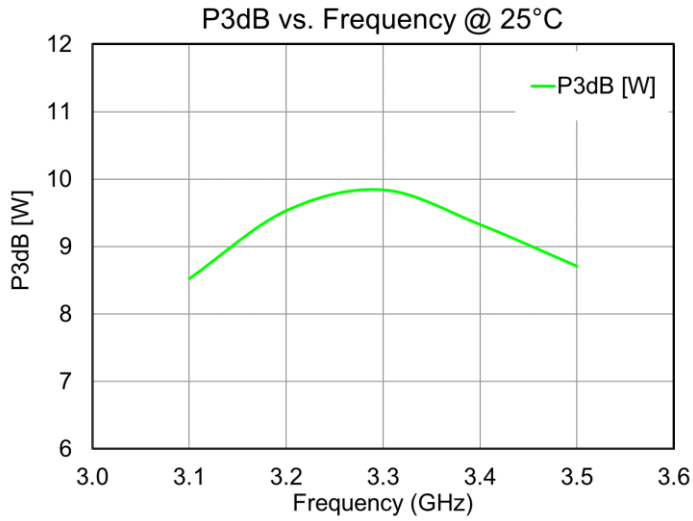

### Two-Tone Performance at 25 °C of 3.1 – 3.5 GHz EVB<sup>1</sup>

Notes:

- 1- Center Frequency = 3.3 GHz. Tone Separation = 10 MHz.

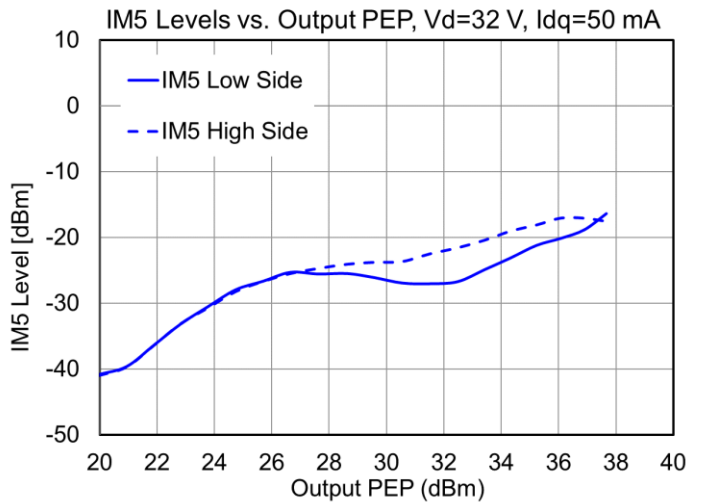
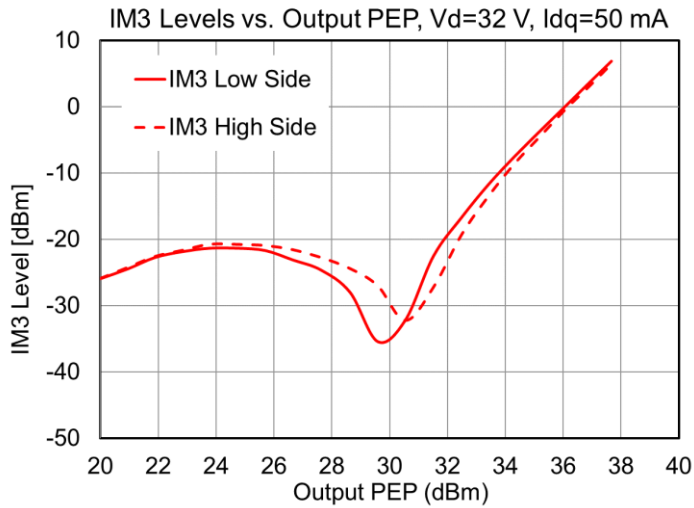



## Pin Layout<sup>1</sup>

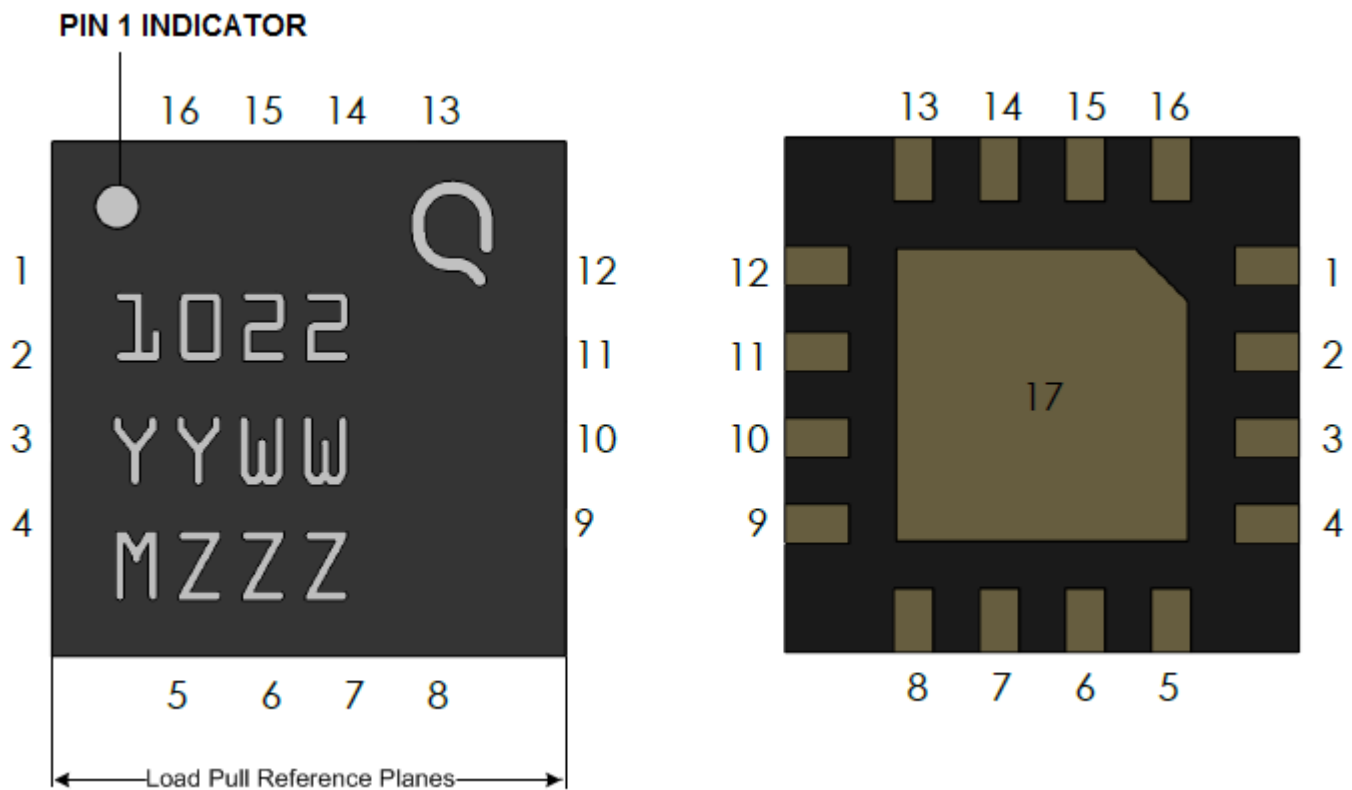

### Notes:

1. The QPD1022 will be marked with the "1022" designator and a lot code marked below the part designator. The "YY" represents the last two digits of the calendar year the part was manufactured, the "WW" is the work week of the assembly lot start, the "MZZZ" is the batch ID.

## Pin Description

Pin	Symbol	Description
2, 3	VG / RF IN	Gate voltage / RF Input
9 – 12	VD / RF OUT	Drain voltage / RF Output
1, 4, 5 – 8, 13 – 16	NC	Not Connected
17	Back Plane	Source to be connected to ground

### Mechanical Drawing<sup>1</sup>

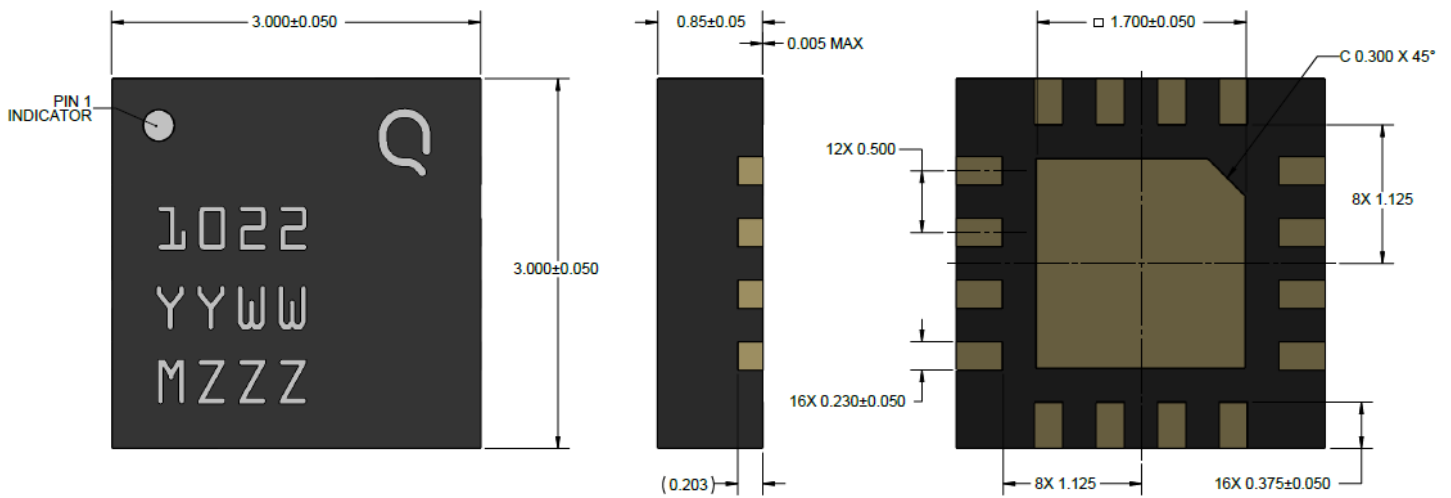

**Notes:**

1- All dimensions are in mm, otherwise noted. Tolerance is  $\pm 0.050$  mm.

Bias-up Procedure	Bias-down Procedure
1. Set $V_G$ to -4 V.	1. Turn off RF signal.
2. Set ID current limit to 100 mA.	2. Turn off VD
3. Apply 32 V VD.	3. Wait 2 seconds to allow drain capacitor to discharge
4. Slowly adjust VG until ID is set to 50 mA.	4. Turn off VG
5. Set ID current limit to 1 A	
6. Apply RF.	

### PCB Layout – 3.1 – 3.5 GHz EVB<sup>1</sup>

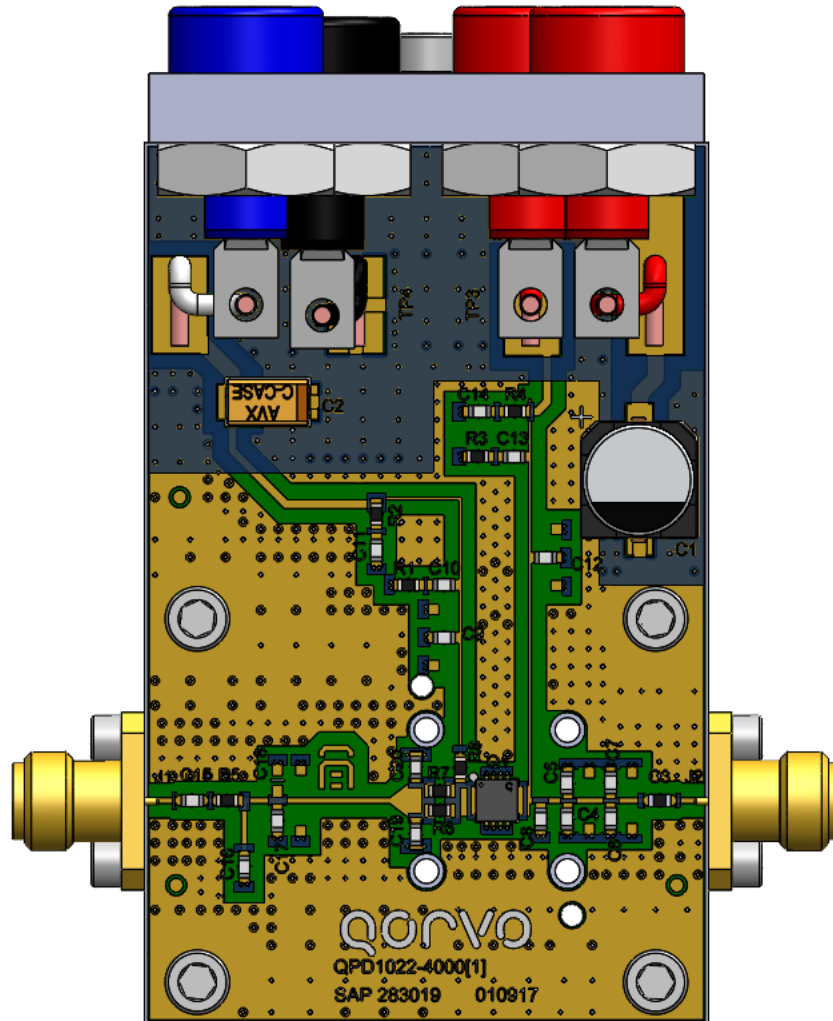

Notes:

- 1- PCB Material is RO4003, 8 mil thick substrate, 1 oz. copper each side.

**Bill Of material – 3.1 – 3.5 GHz EVB**

Ref Des	Value	Description	Manufacturer	Part Number
C10, C13	100 pF	COG 100V 5% 0603 Capacitor	TDK	C1608C0G2E101JT080AA
C11, C14	1 nF	X7R 100V 10% 0603 Capacitor	AVX	06031C102KAT2A
C6 – C8	1.0 pF	RF NPO 250VDC ± 0.05 pF Capacitor	ATC	600S1R0AT250X
C9, C12	9.1 pF	RF NPO 250VDC ± 0.1 pF Capacitor	ATC	600S9R1BT250X
C16	10 pF	RF NPO 250VDC 1% Capacitor	ATC	600S100FT250X
C17	0.2 pF	RF NPO 250VDC ± 0.05 pF Capacitor	ATC	600S0R3AT250X
C15	0.6 pF	RF NPO 250VDC ± 0.05 pF Capacitor	ATC	600S0R6AT250X
C19 – C20	0.8 pF	RF NPO 250VDC ± 0.05 pF Capacitor	ATC	600S0R8AT250X
C4 – C5	2.2 pF	RF NPO 250VDC ± 0.05 pF Capacitor	ATC	600S2R2AT250X
C3	5.6pF	RF NPO 250VDC ± 0.1 pF Capacitor	ATC	600S5R6BT250X
C1	33 uF	80V 20% SVP Capacitor	Panasonic	EEEFK1K330P
C2	10 uF	16V 10% Tantalum Capacitor	AVX	TPSC106KR0500
J1 – J2	–	SMA Panel Mount 4-hole Jack	Gigalane	PSF-S00-000
R5	0 Ohm	0603 5% Thick Film Resistor	ANY	–
R6 – R7	5.1 Ohm	0603 1% Thick Film Resistor	ANY	–
R8	10 Ohm	0603 1% Thick Film Resistor	ANY	–
R1	22 Ohm	0603 5% Thick Film Resistor	ANY	–
R3	5.6 Ohm	0603 5% Thick Film Resistor	ANY	–
R2, R4	33 Ohm	0603 1% Thick Film Resistor	ANY	–

**Recommended Solder Temperature Profile**

