

### Product Overview

The Qorvo QPD1028L is a 750 W ( $P_{3dB}$ ) discrete GaN on SiC HEMT which operates from 1.2 to 1.4 GHz. Input pre-match within the package results in ease of external board match and saves board space. The device is in an industry standard air cavity package and is ideally suited for radar. The device can support both CW and pulsed operations.

Evaluation boards are available upon request.



Ni-780 Package

### Key Features

- Frequency Range: 1.2 to 1.4 GHz
- Linear Gain<sup>1</sup>: 19.8 dB
- Output Power ( $P_{3dB}$ )<sup>1</sup>: 838.5 W
- Drain Efficiency ( $P_{3dB}$ )<sup>1</sup>: 67.3%
- Operating Voltage: 65 V
- CW and Pulse capable

Note 1: EVB Performance @ 1.3 GHz

### Functional Block Diagram

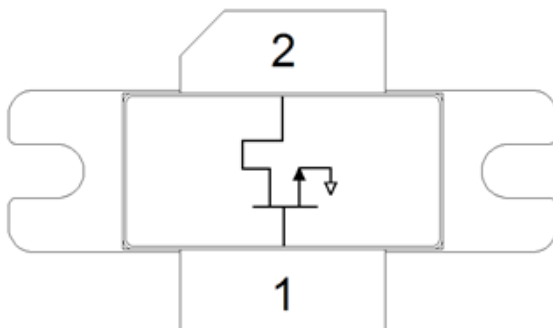

### Applications

- L-Band Radar

### Ordering Information

Part No.	Description
QPD1028L	1.2 – 1.4 GHz Transistor (18 pcs in tray)
QPD1028LEVB	1.2 – 1.4 GHz Evaluation Board

**Absolute Maximum Ratings<sup>1, 2, 3, 4</sup>**

Parameter	Rating	Units
Breakdown Voltage, $BV_{DG}$	225	V
Gate Voltage Range, $V_G$	-7 to +2	V
Drain Current, $I_{D_{MAX}}$	71	A
Gate Current, $I_G$	79	mA
Power Dissipation, Pulsed, $P_{DISS}^2$	605	W
RF Input Power, Pulsed, $P_{IN}^3$	45.2	dBm
Operating Channel Temperature <sup>4</sup>	275	°C
Storage Temperature	-65 to +150	°C

Notes:

1. Operation of this device outside the parameter ranges given above may cause permanent damage
2. Pulsed, 100us PW, 10% DC, Package base at 85 °C
3. Pulsed, 100us PW, 10% DC, T = 25 °C, 50 ohms load
4. Package base at 85 °C

**Recommended Operating Conditions<sup>1, 2, 3, 4</sup>**

Parameter	Min	Typ	Max	Units
Operating Temp. Range	-40	+25	+85	°C
Drain Voltage Range, $V_D$	-	65	-	V
Drain Bias Current, $I_{DQ}$	-	750	-	mA
Drain Current, $I_D^4$	-	19	-	A
Gate Voltage, $V_G^3$	-	-2.7	-	V
Power Dissipation ( $P_D$ ) <sup>4</sup>	-	-	400	W
Power Dissipation ( $P_D$ ), CW <sup>2</sup>	-	-	238	W

Notes:

1. Electrical performance is measured under conditions noted in the electrical specifications table. Specifications are not guaranteed over all recommended operating conditions
2. CW operates at drain voltage of 50 V
3. To be adjusted to desired  $I_{DQ}$
4. Pulsed, 100us PW, 10% DC

**Measured Load Pull Performance – 65V Power Tuned<sup>1, 2</sup>**

Parameter	Typical Values			Units
	1.2	1.3	1.4	
Frequency, F	1.2	1.3	1.4	GHz
Output Power at 3dB compression, $P_{3dB}$	59.5	59.6	59.4	dBm
Drain Efficiency at 3dB compression, $DEff_{3dB}$	62.7	63.6	63.6	%
Gain at 3dB compression, $G_{3dB}$	17.4	17.3	17.4	dB

Notes:

1. Test conditions unless otherwise noted:  $T_A = 25$  °C,  $V_D = 65$  V,  $I_{DQ} = 750$  mA
2. Pulsed, 100 us Pulse Width, 10% Duty Cycle.

**Measured Load Pull Performance – 65V Efficiency Tuned<sup>1, 2</sup>**

Parameter	Typical Values			Units
	1.2	1.3	1.4	
Frequency, F	1.2	1.3	1.4	GHz
Output Power at 3dB compression, $P_{3dB}$	57.7	57.9	57.4	dBm
Drain Efficiency at 3dB compression, $DEff_{3dB}$	76.0	76.7	74.4	%
Gain at 3dB compression, $G_{3dB}$	19.4	19.1	19.0	dB

Notes:

1. Test conditions unless otherwise noted:  $T_A = 25$  °C,  $V_D = 65$  V,  $I_{DQ} = 750$  mA
2. Pulsed, 100 us Pulse Width, 10% Duty Cycle.

## RF Characterization – 1.2 – 1.4 GHz EVB Performance at 1.3 GHz <sup>1</sup>

Parameter	Min	Typ	Max	Units
Linear Gain, $G_{LIN}$	–	19.8	–	dB
Output Power at 3dB compression point, P3dB	–	59.2	–	dBm
Drain Efficiency at 3dB compression point, DEff3dB	–	67.3	–	%
Gain at 3dB compression point, G3dB	–	16.8	–	dB
Gate Leakage, $V_D = +10$ V, $V_G = -3.3$ V	-40	–	–	mA

**Notes:**

1.  $V_D = +65$  V,  $I_{DQ} = 750$  mA, Temp = +25 °C, Pulse Width = 100 uS, Duty Cycle = 10%

## RF Characterization – Mismatch Ruggedness at 1.2, 1.3, 1.4 GHz <sup>1, 2, 3</sup>

Symbol	Parameter	dB Compression	Typical
VSWR	Impedance Mismatch Ruggedness	3	10:1

**Notes:**

1. Test conditions unless otherwise noted:  $T_A = +25$  °C,  $V_D = +65$  V,  $I_{DQ} = 750$  mA
2. Input drive power is determined at pulsed 3dB compression under matched condition at EVB output connector
3. Pulse Width = 100us, Duty cycle = 10%

Thermal and Reliability Information – Pulsed <sup>1</sup>

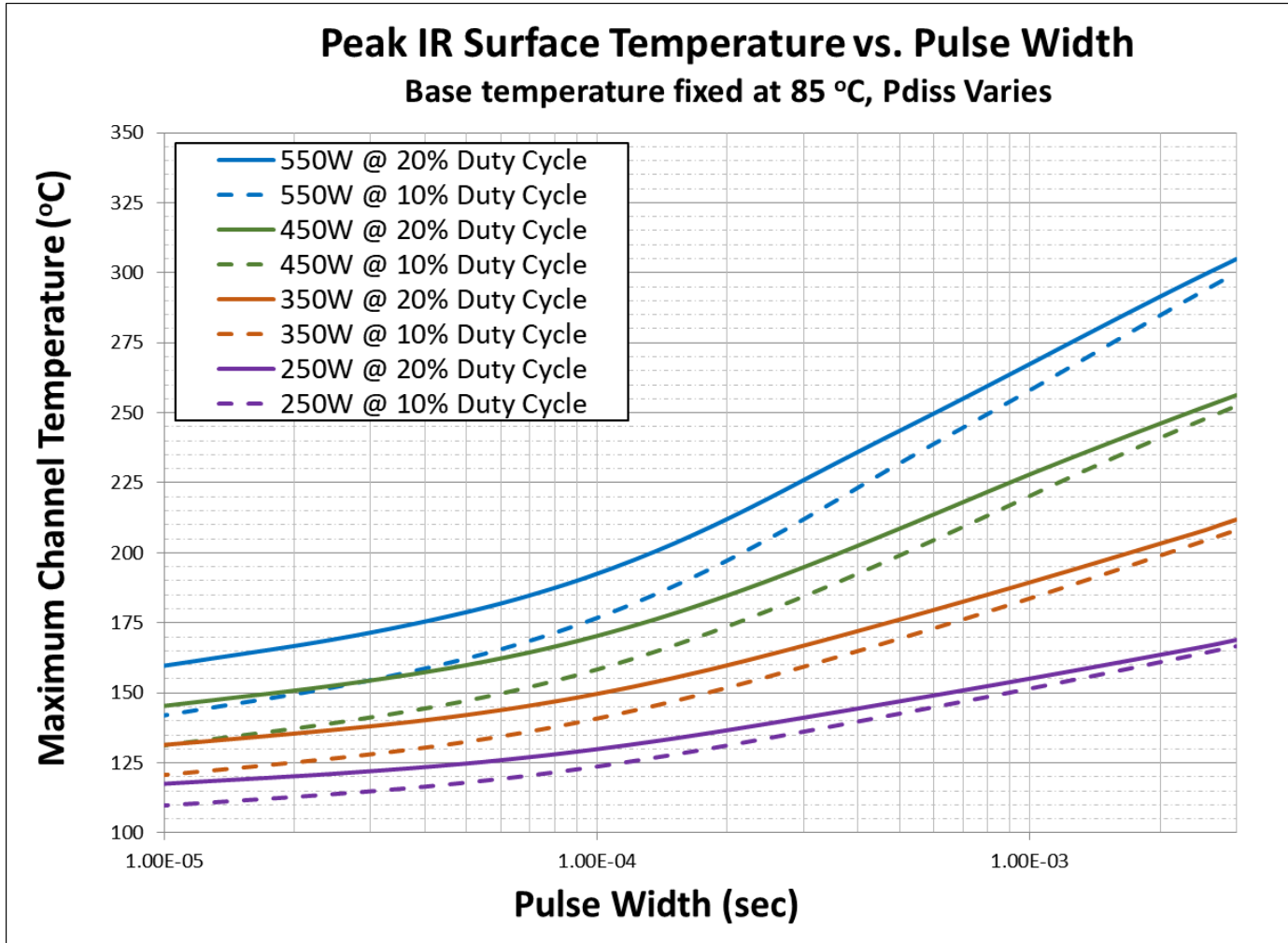

Parameter	Conditions	Values	Units
Thermal Resistance, IR <sup>1</sup> ( $\theta_{JC}$ )	85 °C Case backside Temperature	0.21	°C/W
Peak IR Surface Temperature <sup>1</sup> ( $T_{ch}$ )	P <sub>diss</sub> = 350 W, Pulse: 300 us PW, 10% DC	160	°C

Notes:

1. Refer to the following document [GaN Device Channel Temperature, Thermal Resistance, and Reliability Estimates](#)

Measured Load-Pull Smith Charts at 65V <sup>1,2</sup>

Notes:

1. Test Conditions:  $V_D = 65\text{ V}$ ,  $I_{DQ} = 750\text{ mA}$ , 100 us Pulse Width, 10% Duty Cycle, Temp = 25°C.
2. The performance shown below is for only half of the device out of the two independent amplification paths.

1.2GHz, Load-pull

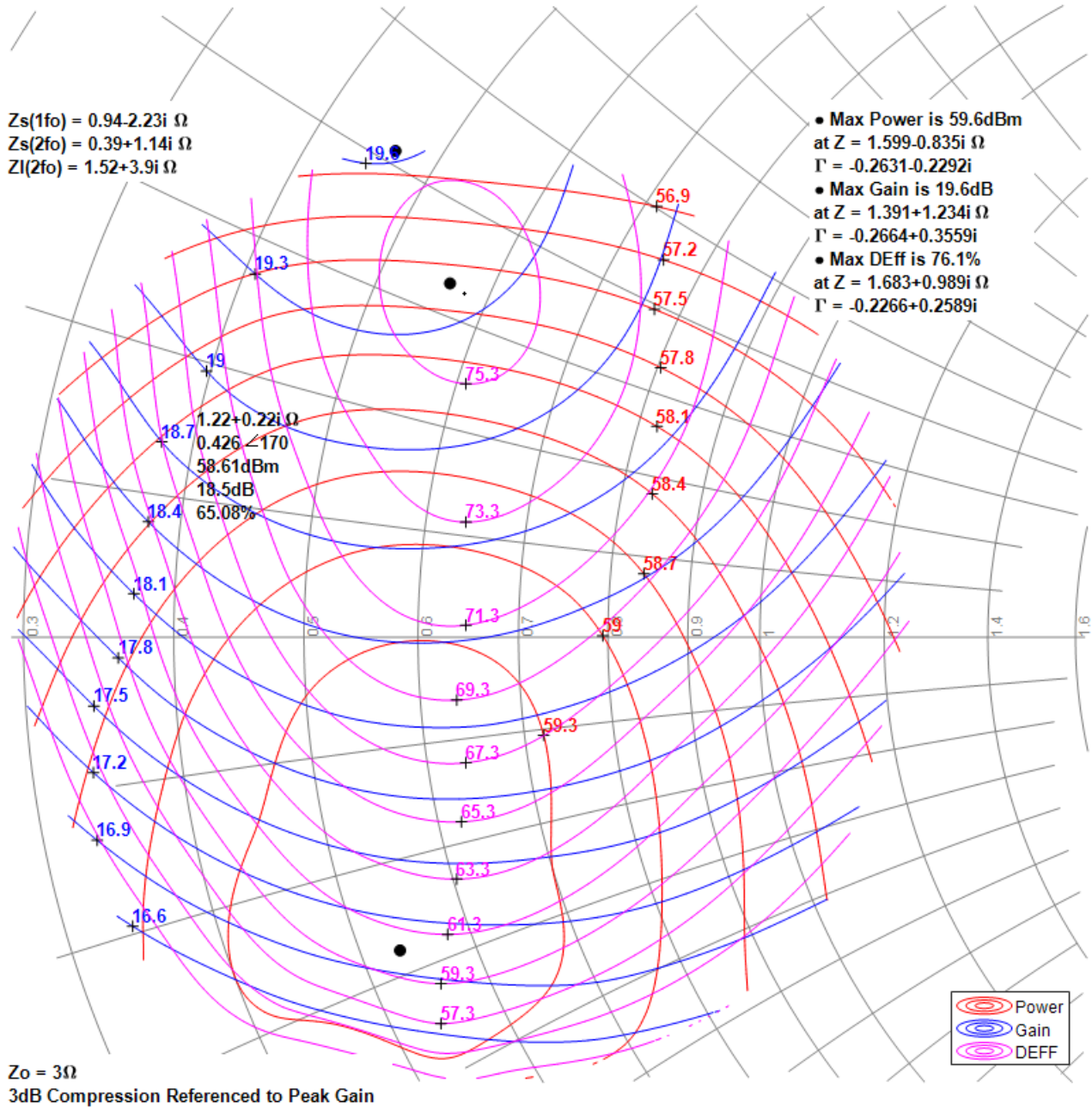

Measured Load-Pull Smith Charts at 65V <sup>1,2</sup>

Notes:

1. Test Conditions:  $V_D = 65\text{ V}$ ,  $I_{DQ} = 750\text{ mA}$ , 100 us Pulse Width, 10% Duty Cycle, Temp = 25°C.
2. The performance shown below is for only half of the device out of the two independent amplification paths.

1.3GHz, Load-pull

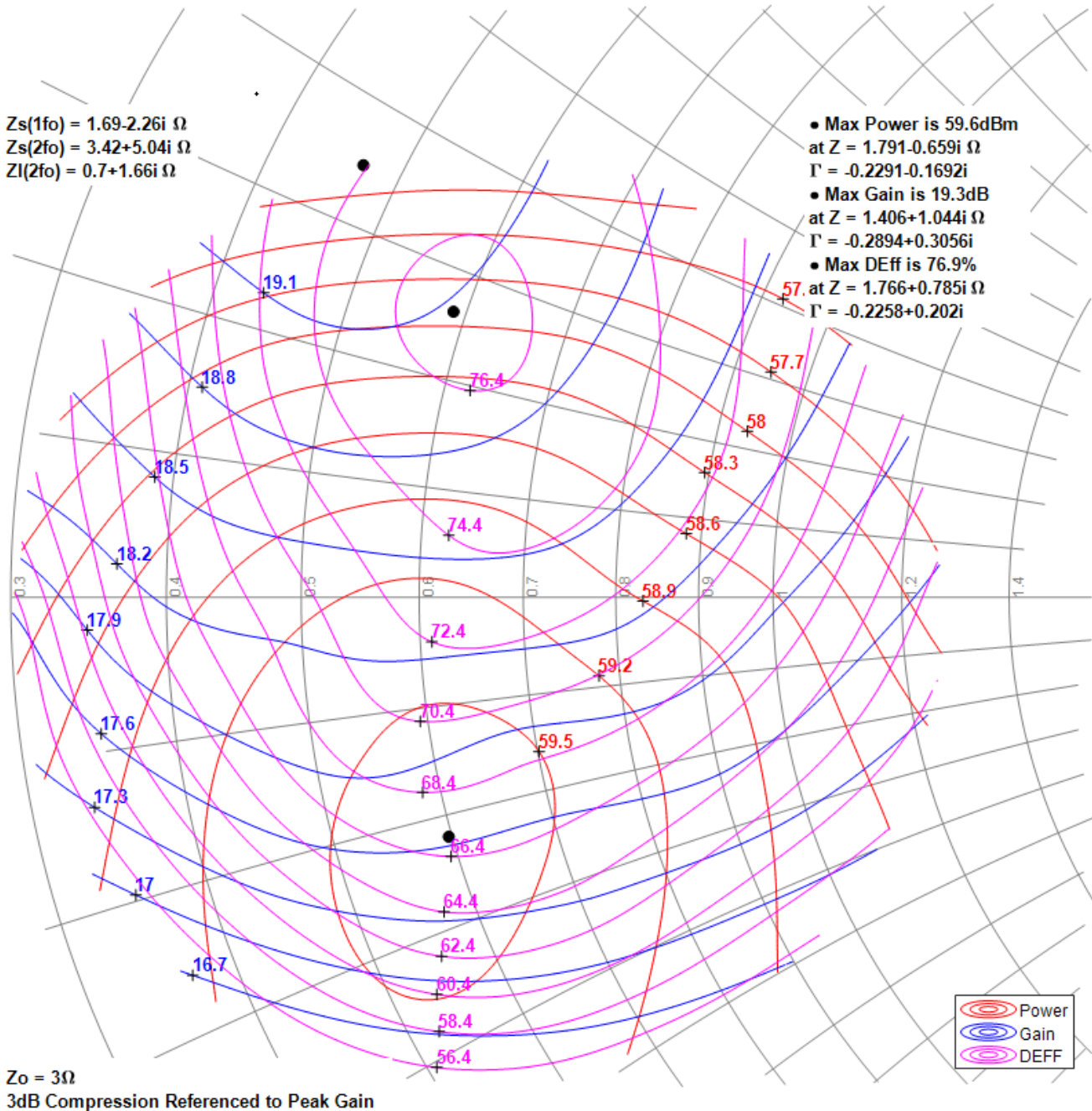

Measured Load-Pull Smith Charts at 65V <sup>1, 2,</sup>

Notes:

1. Test Conditions:  $V_D = 65\text{ V}$ ,  $I_{DQ} = 750\text{ mA}$ , 100 us Pulse Width, 10% Duty Cycle, Temp = 25°C.
2. The performance shown below is for only half of the device out of the two independent amplification paths.

1.4GHz, Load-pull

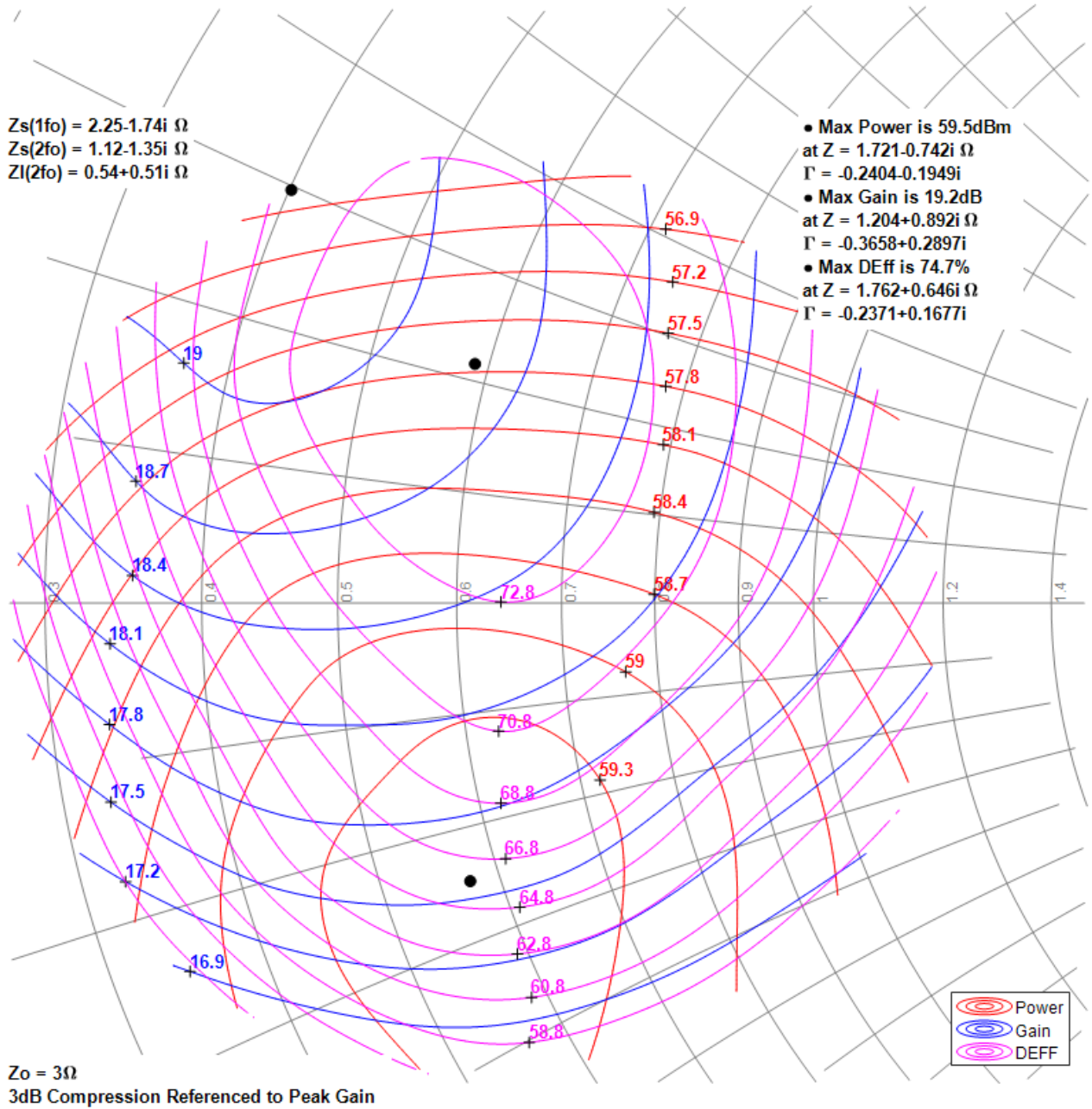

Pin Configuration and Description<sup>1</sup>

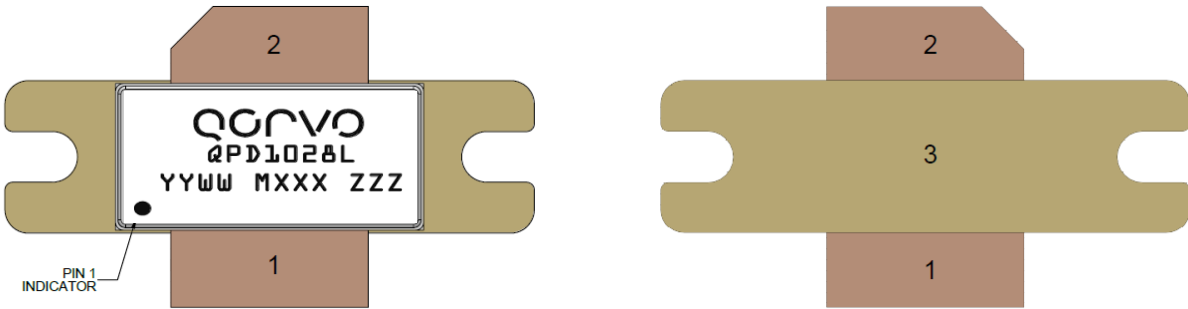

Note:

- The QPD1028L will be marked with the “QPD1028L” designator and a lot code marked below the part designator. The “YY” represents the last two digits of the calendar year the part was manufactured, the “WW” is the work week of the assembly lot start, the “MXXX” is the production lot number, and the “ZZZ” is an auto-generated serial number.

Pin	Symbol	Description
1	RF IN / V <sub>G</sub>	Gate
2	RF OUT / V <sub>D</sub>	Drain
3	Source	Source / Ground / Backside of part



Mechanical Drawing<sup>1-7</sup>

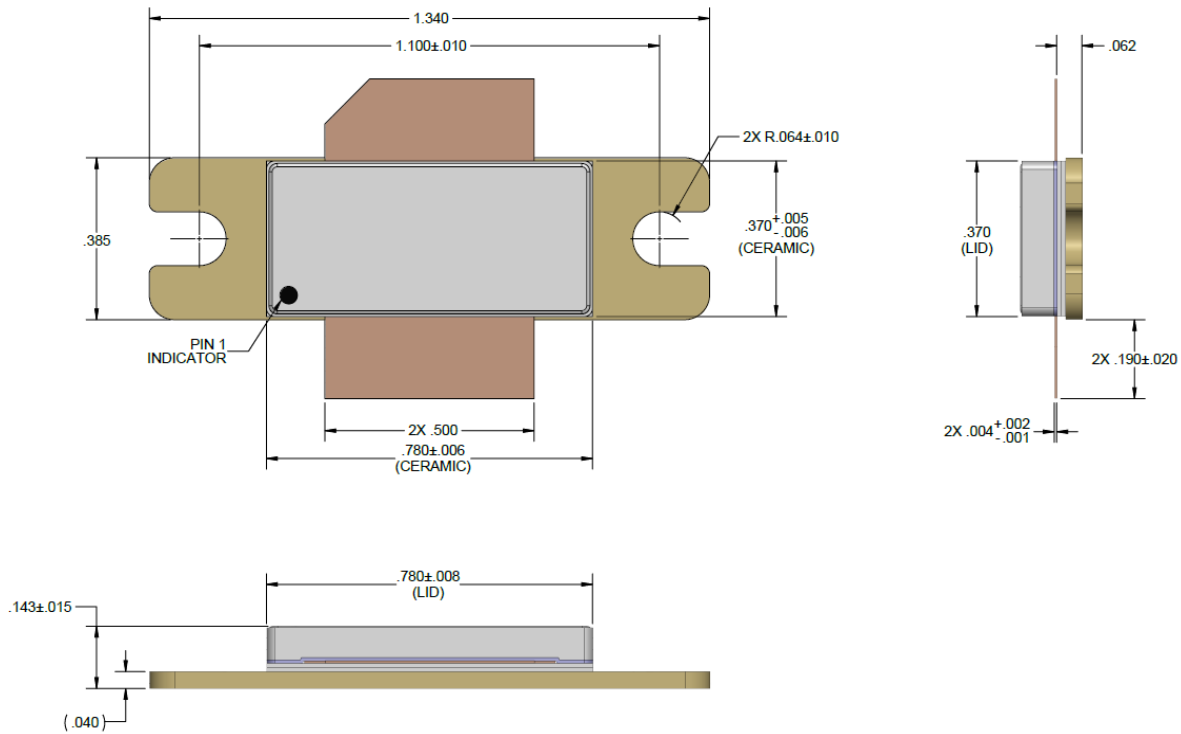

Notes:

1. All dimensions are in inches.
2. Dimension tolerance is ± 0.005 inches, unless noted otherwise.
3. Package Base: Ceramic/Metal, Package Lid: Ceramic.
4. Package exposed metallization is gold plated.
5. Part is epoxy sealed.
6. Part meets industry NI780 footprint.
7. Body dimensions do not include lid shift or epoxy run out which can be up to 0.020 inches per side.

## 1.2 – 1.4 GHz Application Circuit - Schematic

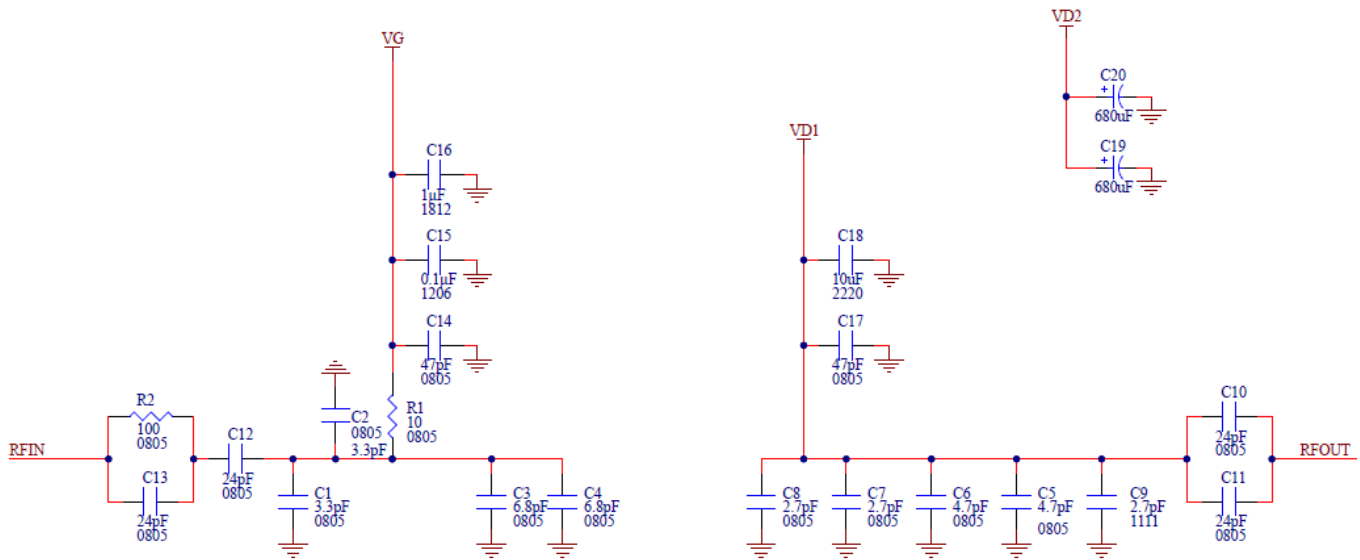

## Biasing Procedure

### Bias On

1. Turn ON  $V_G$  to  $-5$  V.
2. Turn ON  $V_D$  to  $+65$  V.
3. Slowly adjust  $V_G$  until  $I_D = 750$  mA.  
(Typically,  $V_G = -2.8$  V.)
4. Turn ON RF.

### Bias Off

1. Turn OFF RF.
2. Adjust  $V_G$  to  $-5$  V.
3. Turn OFF  $V_D$ .
4. Wait two (2) seconds to allow drain capacitors to discharge.
5. Turn OFF  $V_G$ .

## 1.2 – 1.4 GHz Application Circuit – EVB Assembly <sup>1,2</sup>

Notes:

- 1. PCB material is RO4350B 0.030" thick, 2 oz. copper each side.
- 2. EVB is rated for pulsed operation only.

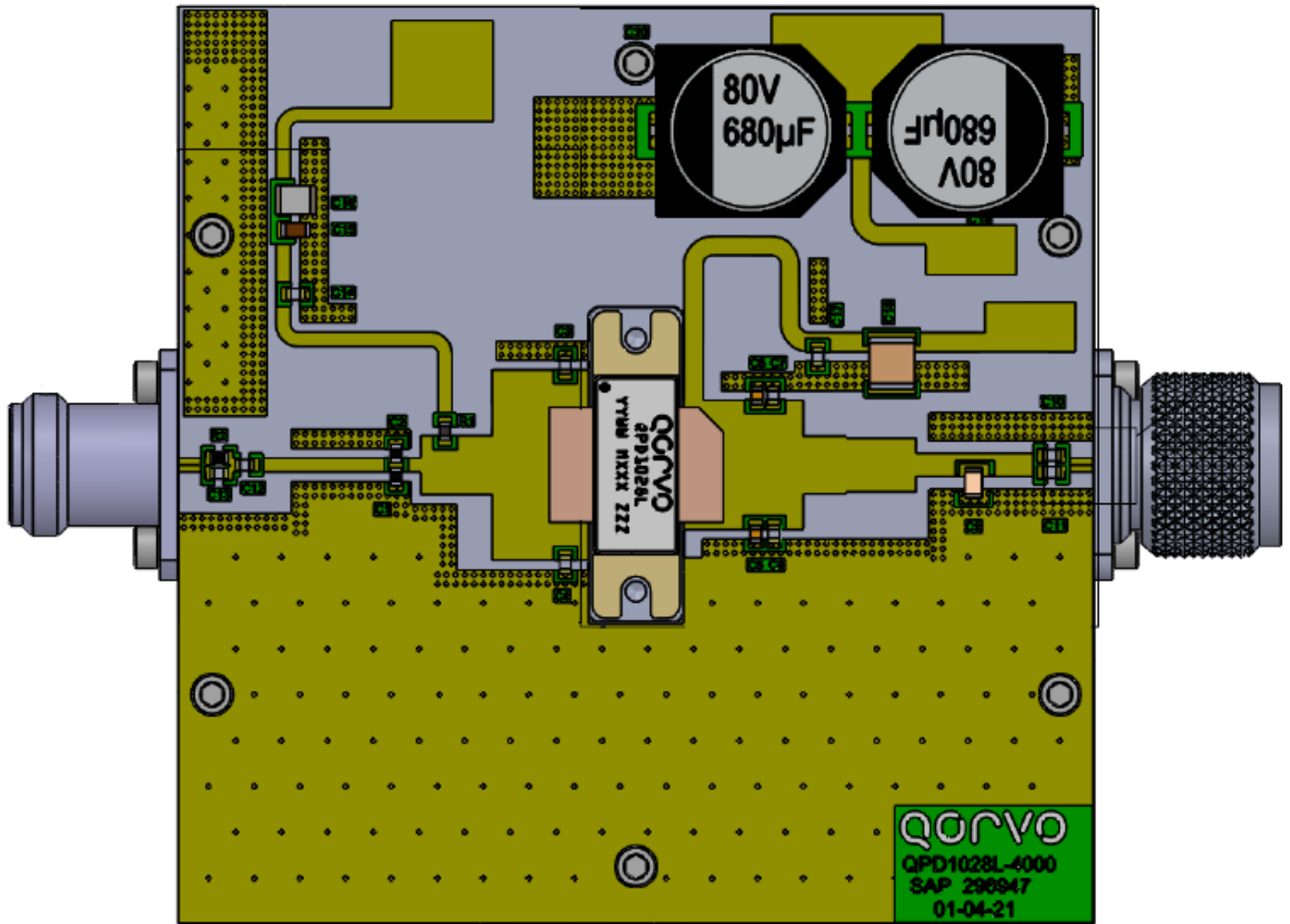



## 1.2 – 1.4 GHz Application Circuit EVB – Bill of Material

Ref Des	Qty	Description	Mfg Name	Mfg Part #
U1	1	750W, 65V, Pre-matched, 1.2-1.4GHz	Qorvo	QPD1028L
C1, C2	2	CAP, 3.3pF, 0.1pF, 250V, C0G, 0805	American Technical Ceramics	600F3R3BT250XT
C3, C4	2	CAP, 6.8pF, $\pm 0.1$ pF, 250V, C0G, 0805	American Technical Ceramics	600F6R8BTT250XT
C5, C6	2	CAP, 4.7pF, 0.1pF, 250V, C0G, 0805	American Technical Ceramics	600F4R7BT250XT
C7, C8	2	CAP, 2.7pF, 0.1pF, 250V, C0G, 0805	American Technical Ceramics	600F2R7BT250XT
C9	1	CAP, 2.7pF, $\pm 0.1$ pF, 500V, C0G, ATC-B	American Technical Ceramics	800B2R7BT500X
C10, C11, C12, C13	4	CAP, 24pF, 1%, 250V, C0G, 0805	American Technical Ceramics	600F240FT250XT
C14, C17	2	CAP, 47pF, 5%, 250V, HI-Q, 0805	American Technical Ceramics	600F470JT250XT
C15	1	CAP, 0.1uF, 10%, 100V, X7R, 1206	AVX Corporation	12061C104K4T2A
C16	1	CAP, 1uF, 10%, 100V, STD, 1812	AVX Corporation	18121C105KAT2A
C18	1	CAP, 10uF, 20%, 100V, X7S, 2220	TDK Singapore LTD	C5750X7S2A106M230KB
C19, C20	2	CAP, 680uF, $\pm 20$ %, 80V, Alum Cap, SMD	Vishay Americas, Inc	MAL215099708E3
R1	1	RES, 10 OHM, 1%, 1/8W, 0805	Panasonic Industrial	ERJ-6ENF10R0V
R2	1	RES, 100 OHM, 5%, 1/8w, 0805	Kamaya, Inc	RMC1/10-101JTP
RFOUT	1	CONN, N, RECP ST PANEL FLG MNT	HUBER+SUHNER, Inc.	23_N-50-0-33/133_NE
RFIN	1	CONN, COAXIAL, 11 GHz, N-FLANGE, FEMALE	HUBER+SUHNER, Inc.	23_N-50-0-33/133_NE

### P3dB Performance over Temperature of 1.2 – 1.4 GHz EVB <sup>1</sup>

Notes:

1. Test Conditions:  $V_D = 65\text{ V}$ ,  $I_{DQ} = 750\text{ mA}$ , 100 us Pulse Width, 10% Duty Cycle.

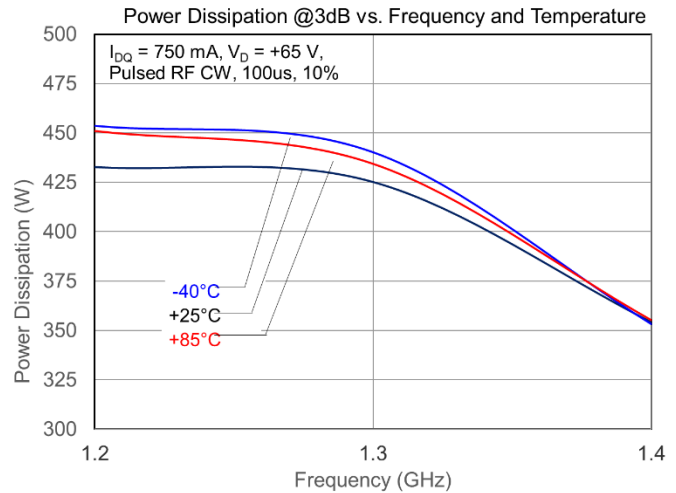
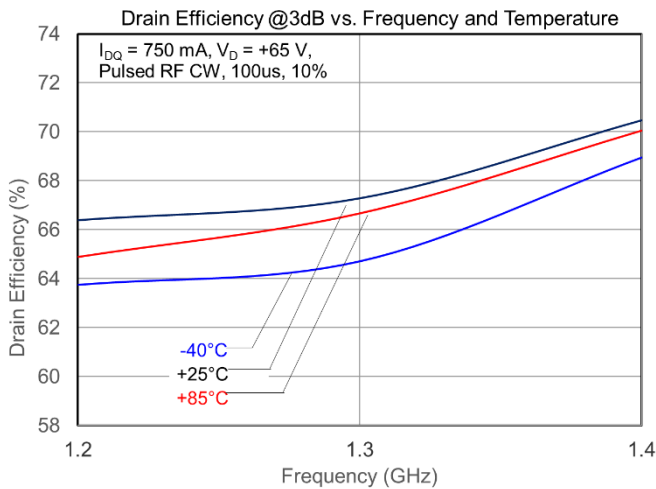
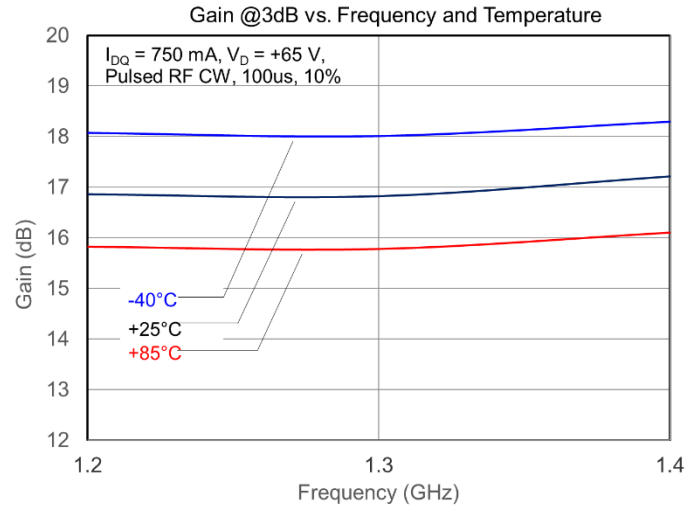
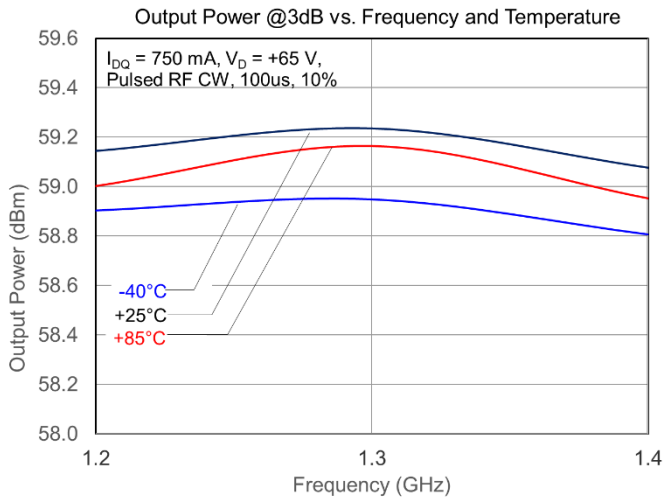

Power Drive-up Performance over Temperatures of 1.2 – 1.4 GHz EVB <sup>1</sup>

Notes:

1. Test Conditions:  $V_D = 65\text{ V}$ ,  $I_{DQ} = 750\text{ mA}$ , 100 us Pulse Width, 10% Duty Cycle.

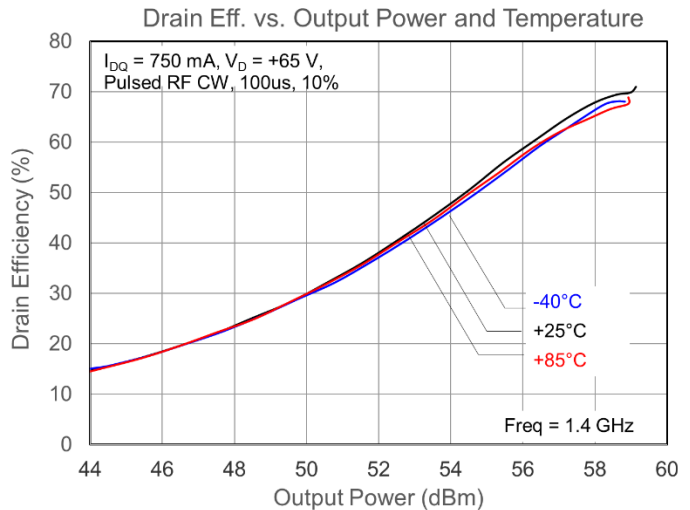
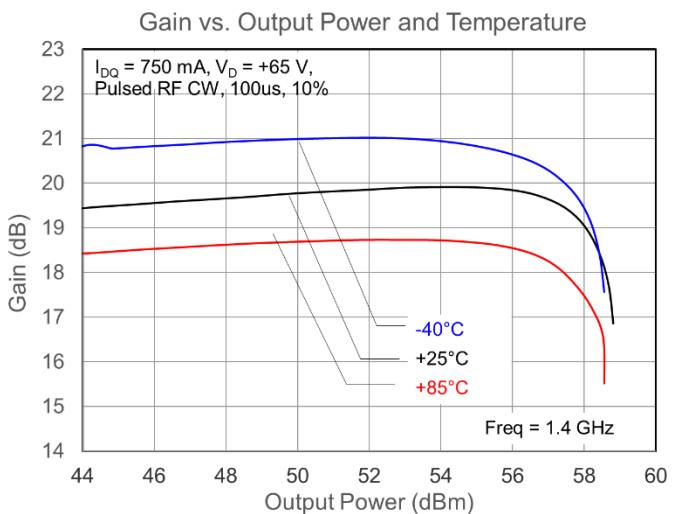
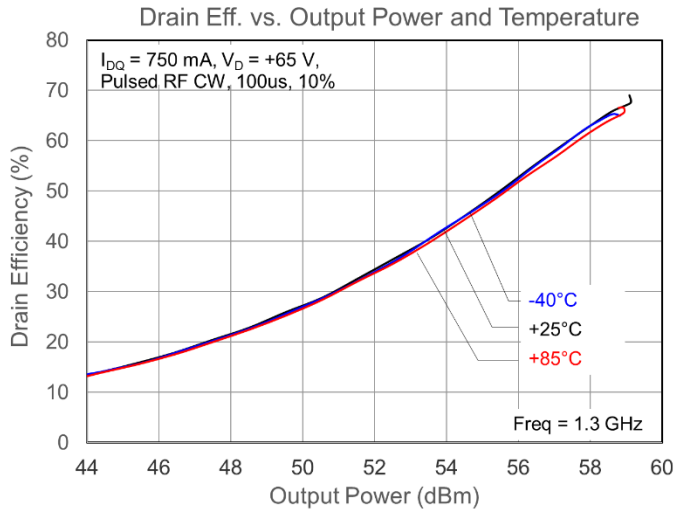
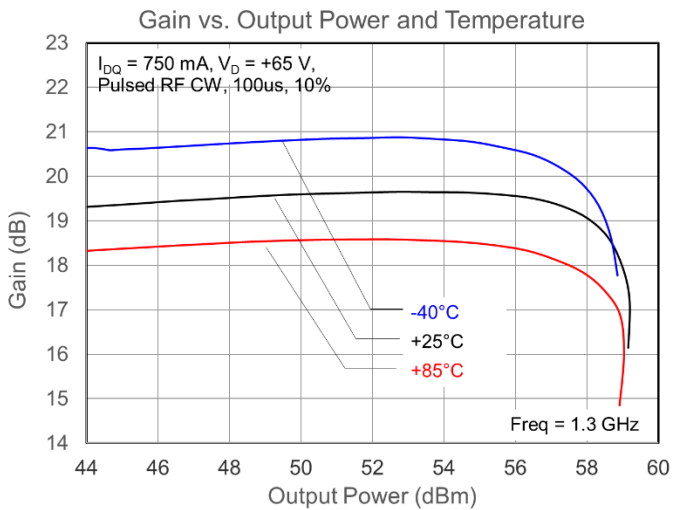
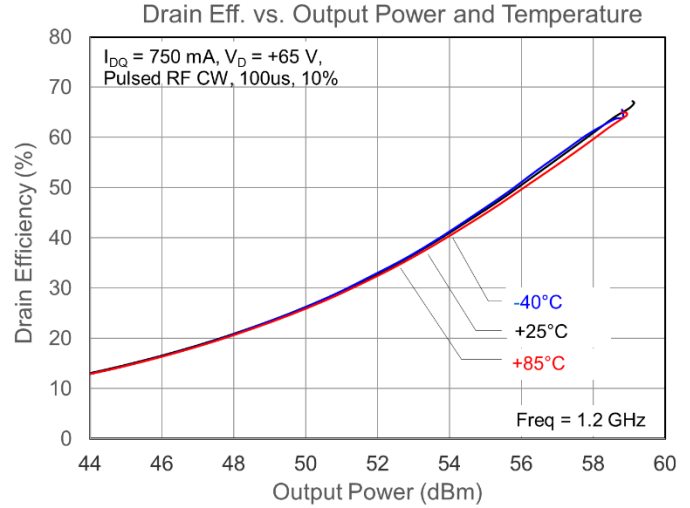
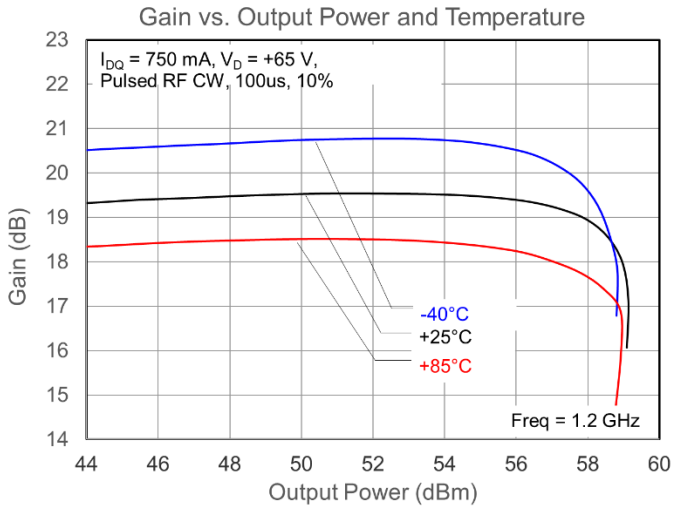

**Recommended Solder Temperature Profile**

